

Art. Nr. 25952766; 76955415

LKZ 40605

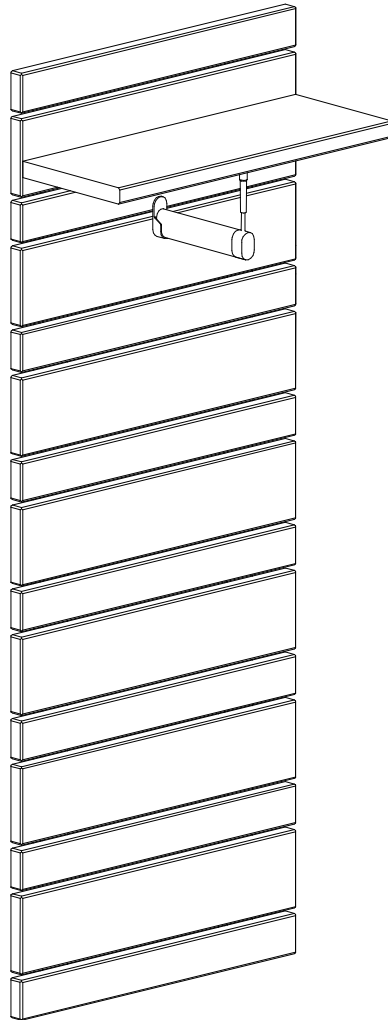

- | | | | |
|-----------|------------------------------------|-----------|--------------------------------|
| D | Montageanleitung | GB | Assembly instructions |
| FR | Notice de montage | IT | Istruzioni di montaggio |
| NL | Handleiding voor de montage | PL | Instrukcja montażu |
| CZ | Montážní návod | SK | Návod na montáž |
| HU | Szerelési útmutató | RO | Instrukțiuni de montaj |
| TR | Montaj talimatı | RU | Инструкция по монтажу |

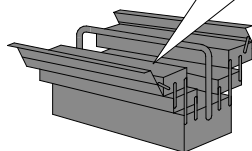
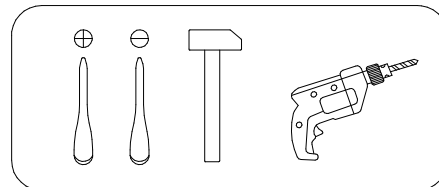
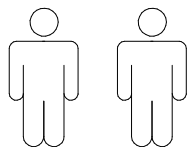

0
10
20
30
40
50
60
70
80
90
100
110
120
130
140
150
160
170
180
190
200





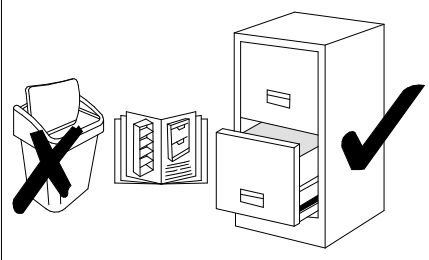
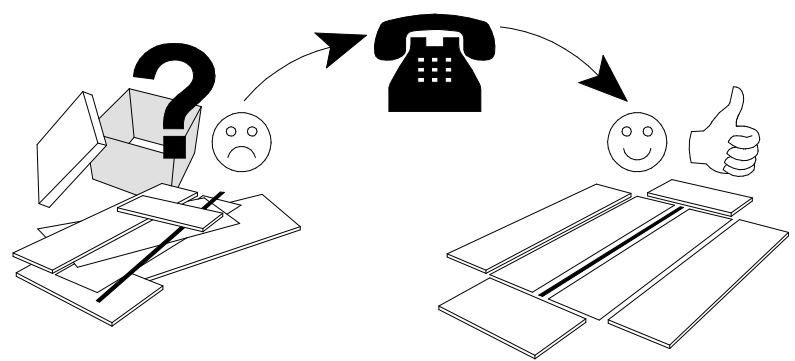



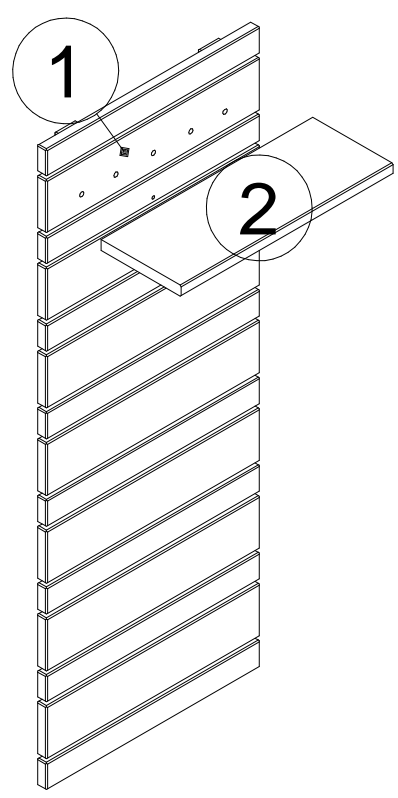

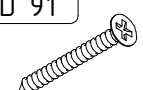

Service · Dienstverlening · Serwis · Servis · Сервисная служба

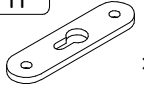
Name · Naam · Nazwa · Isim · Название
Nr. · No. · Номер
Typ · Type · Tip · Тип

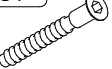

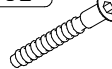

N	Size/MaB (mm)	Qty	✓
1	1038x400	1	
2	396x150	1	

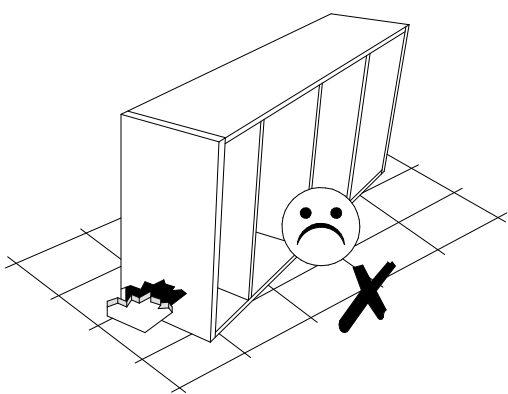
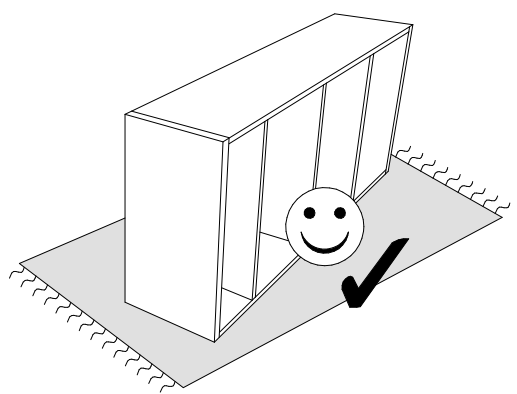

 D 91 4.0x60 x2	 A 1 8x30 x2	 N 2 8x50 x2
 D 66 4,5x15 x2	 X 1 x2	 D 30 3.5x15 x5
 P 67 7x70 x2	 J 47 SW4 x1	 P 62 7x50 x1
 L 40 x1	 J 65 30x15 x1	 J 86 x1
 J 14 x1		

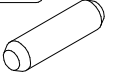



A 1	8x30
	x2

D 66	4,5x15
	x2

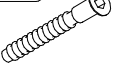
D 30	3,5x15
	x1

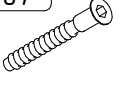
P 62	7x50
	x1

P 67	7x70
	x2

L 40	
	x1

J 14	
	x1

J 47	SW4
	x1

J 65	30x15
	x1

J 86	
	x1

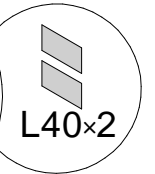
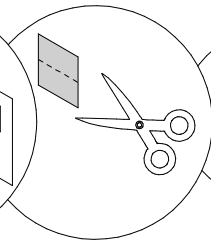
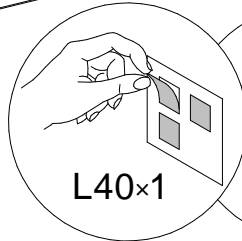
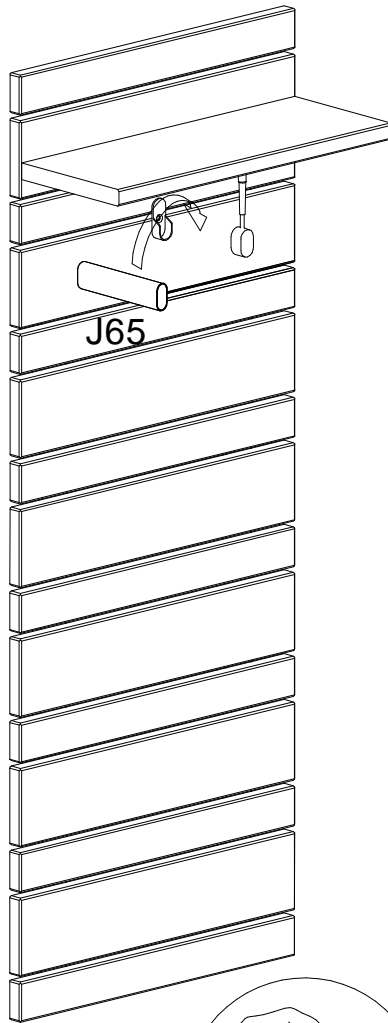
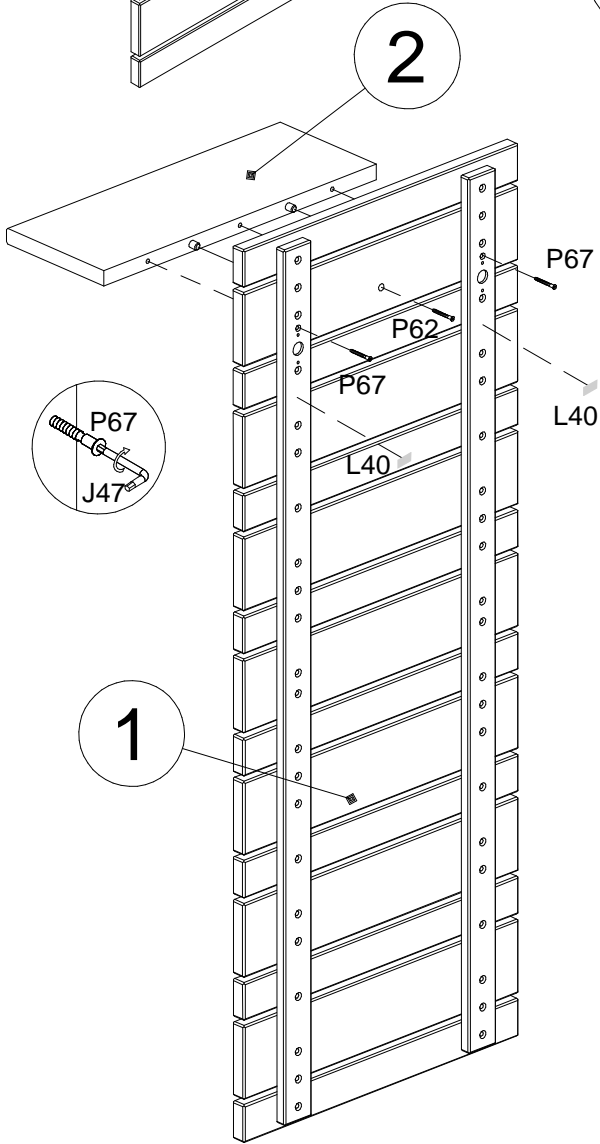
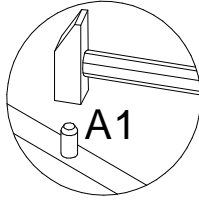
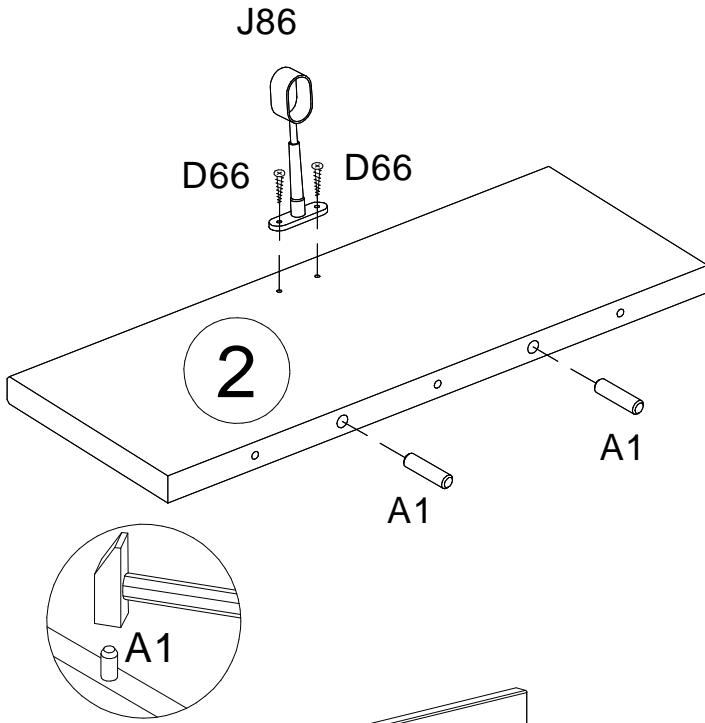
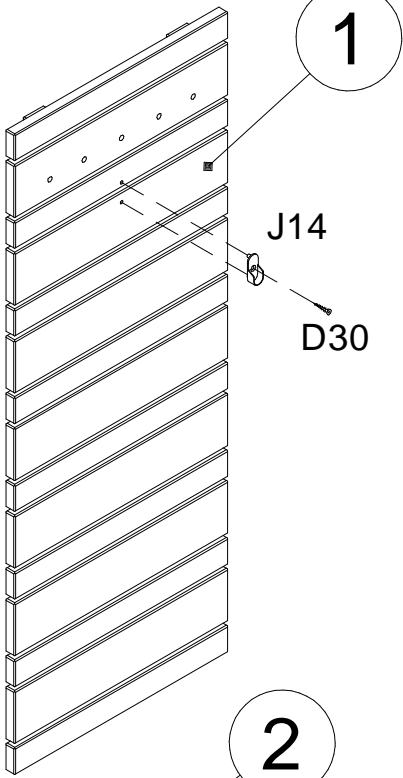

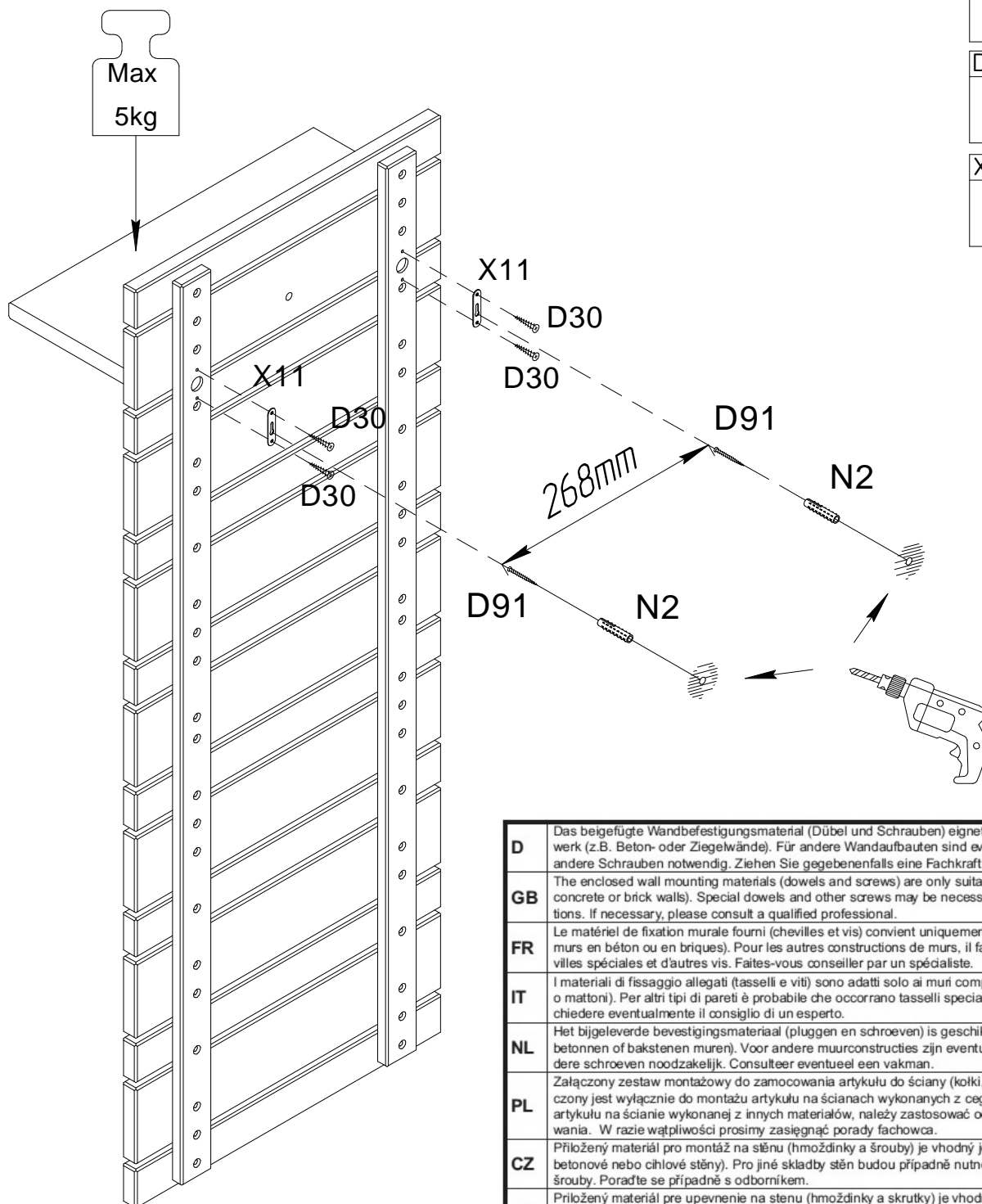

N 2	8x50
	x2
D 30	3.5x15
	x4
D 91	4.0x60
	x2
X 11	
	x2

D	Das beigefügte Wandbefestigungsmaterial (Dübel und Schrauben) eignet sich nur für festes Mauerwerk (z.B. Beton- oder Ziegelwände). Für andere Wandaufbauten sind eventuell Spezialdübel und andere Schrauben notwendig. Ziehen Sie gegebenenfalls eine Fachkraft zurate.
GB	The enclosed wall mounting materials (dowels and screws) are only suitable for solid masonry (e. g. concrete or brick walls). Special dowels and other screws may be necessary for other wall constructions. If necessary, please consult a qualified professional.
FR	Le matériel de fixation murale fourni (chevilles et vis) convient uniquement à des murs solides (p. ex. murs en béton ou en briques). Pour les autres constructions de murs, il faut éventuellement des chevilles spéciales et d'autres vis. Faites-vous conseiller par un spécialiste.
IT	I materiali di fissaggio allegati (tasselli e viti) sono adatti solo ai muri compatti (ad es. di calcestruzzo o mattoni). Per altri tipi di pareti è probabile che occorrano tasselli speciali e altre tipologie di viti. Richiedere eventualmente il consiglio di un esperto.
NL	Het bijgeleverde bevestigingsmateriaal (pluggen en schroeven) is geschikt voor vaste muren (bijv. betonnen of bakstenen muren). Voor andere muurconstructies zijn eventueel speciale pluggen en andere schroeven noodzakelijk. Consulteer eventueel een vakman.
PL	Załączony zestaw montażowy do zamocowania artykułu do ściany (kotki, wkręty, haki itp.), przeznaczony jest wyłącznie do montażu artykułu na ścianach wykonanych z cegły lub betonu. Przy montażu artykułu na ścianie wykonanej z innych materiałów, należy zastosować odpowiednio do niej zamocowania. W razie wątpliwości prosimy zasięgnąć porady fachowca.
CZ	Příložený materiál pro montáž na stěnu (hmoždinky a šrouby) je vhodný jen pro pevné zdivo (např. betonové nebo cihlové stěny). Pro jiné skladby stěn budou případně nutné speciální hmoždinky a jiné šrouby. Poradte se případně s odborníkem.
SK	Priložený materiál pre upevnenie na stenu (hmoždinky a skrutky) je vhodný len pre pevné murivo (napr. betónové alebo tehlové steny). Pre iné steny sú potrebné príp. špeciálne hmoždinky a iné skrutky. V prípade potreby sa poraďte s odborníkom.
HU	A mellékelt falirögzítőkészlet (tipl és csavarok) csak tömött falazatban (pl. betonfalban, téglafalban) használható. Más fal típusokhoz speciális tiplre és csavarra lesz szükség. Szükség esetén kérje ki egy szakember véleményét.
RO	Materialul furnizat pentru montajul de perete (dibluri și șuruburi) este adecvat numai pentru zidărie solidă (de exemplu pereți din beton sau din cărămidă). Pentru alte structuri de pereți, este posibil să fie necesare dibluri speciale, precum și alte șuruburi. Dacă este necesar, consultați un specialist.
TR	Teslimat kapsamındaki duvar tipi sabitleme materyali (dübel ve vidalar) sadece beton ve tuğla duvarlar gibi sağlam duvar yapıları için uygundur. Başka duvar yapıları için özel dübeller veya başka vidalar gerekli olabilir. Gerekirse bir uzmandan yardım alın.
RU	Входящий в комплект поставки материал для крепления на стене (дюбели и болты) предназначен только для прочных каменных стен (например, бетонных или кирпичных). Для других типов стен используйте по мере необходимости специальные дюбели и другие болты. По мере необходимости обратитесь за помощью к специалистам.