

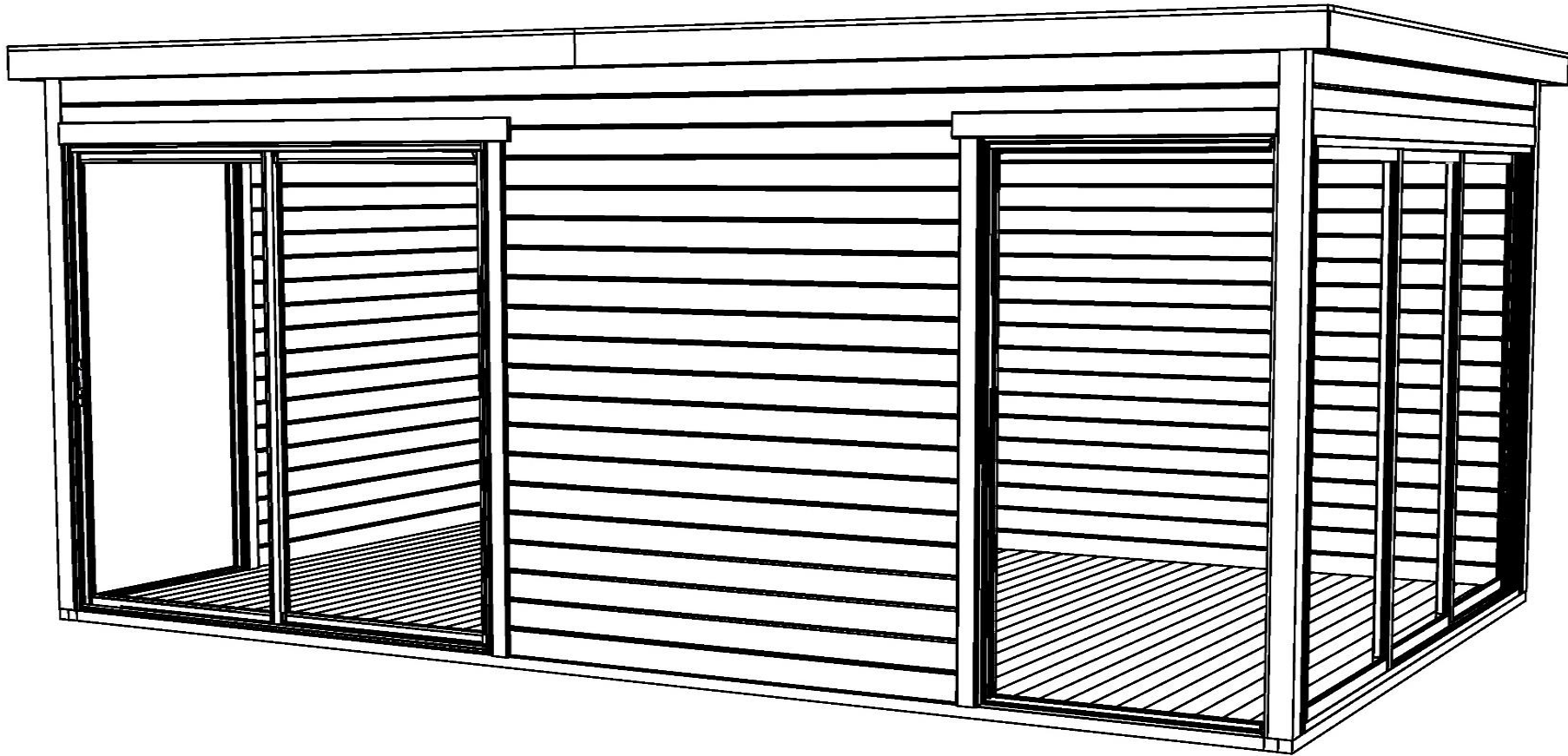

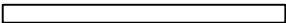







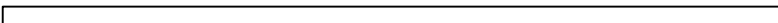
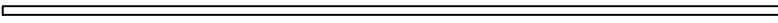

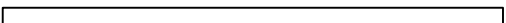

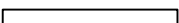

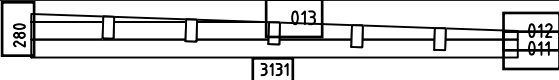

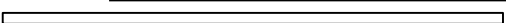

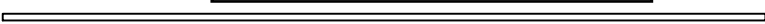
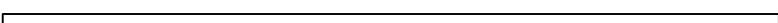









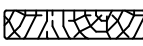



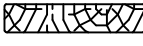
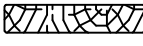
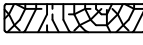
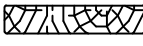
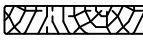
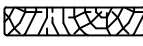
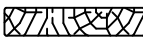
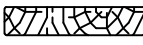
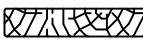
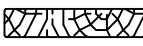
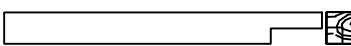
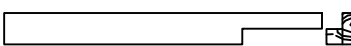
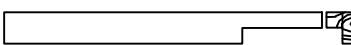
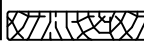
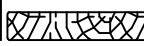







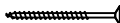
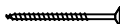
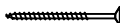
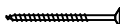











*Domeo 3*  
*Art. Nr. 4423819*  
*1/28*

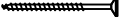

Pos	11.03.2020	Piece list - Stückliste - Liste des pièces - Elementi - Stuklijst - Tükital	2/28	Q	P (mm)	L (mm)
001				18	44x114	1818
002				21	44x114	5000
003				2	44x114	5000
004				1	44x57	5000
005				18	44x114	2103
006				4	44x114	3219
007				2	44x114	3219
008				2	44x96	1125
009				32	44x114	1125
010				1	44x114	3131
WC-1				1		
IAR3		Foundation - Fundament - Fondation - Fondamenta - Fundering - Immutatud alusraam 		8	45x70	4908
IAR1		Foundation - Fundament - Fondation - Fondamenta - Fundering - Immutatud alusraam 		4	45x70	3219
IAR2		Foundation - Fundament - Fondation - Fondamenta - Fundering - Immutatud alusraam 		1	45x70	100
RV1		Lath - Pfetten - Liteau - Piccola asse - Gordingen - Roov 		1	44x44	4908
A-PR1		Roof beam - Dachbalken - Panne de toit - Perlina del tetto - Gordingen / dakbalk - Pärlin 		5	70x140	4993
FB		Floor boards - Fussbodenbretter - Lame de plancher - Pavimento - Vloerhout - Põrandataud 		56	90x18	3128
DB		Roof boards - Dachbretter - Voliges - Perlina per tetto - Dakhout - Katuselaud 		56	90x18	3250
		Floor fillet - Fussbodenteiste - Corniere de finition du plancher - Finitura per pavimento (battisco pa) - Vloerafwerktijst - Põrandatiist 			18x18	22.48
DL5		Batten - Deckleiste - Profils de finition angles a l'exterieur - Asse - Afdek tijst - Kattetiist 		1	15x45	2203
DL4		Batten - Deckleiste - Profils de finition angles a l'exterieur - Asse - Afdek tijst - Kattetiist 		1	15x45	2263
DPL1		Roofing felt fillet - Dachpappenleiste - Baguette de fixation du feutre bitumeux - Asse per fissaggio guaina bituminosa - Afdektijst asfaltpapier - Katusepapiist 		2	18x58	2642
DPL2		Roofing felt fillet - Dachpappenleiste - Baguette de fixation du feutre bitumeux - Asse per fissaggio guaina bituminosa - Afdektijst asfaltpapier - Katusepapiist 		2	18x58	3357

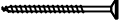
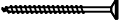
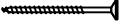
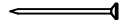
Pos	11.03.2020	Piece list - Stückliste - Liste des pièces - Elementi - Stuklijst - Tükítabel Art.Nr. 4423819	3/28	Q	P (mm)	L (mm)
TP1	Diagonal support batten - Hilfsleiste - Tasseau - Listelli per rinforzare - Timmerhout - Tugitaud		4	18x90	350	
FF6	Fixing fillet - Fixierungsleiste - Profil de fixation - Massello di fissaggio - Bevestiging lijstwerk - Tenderlijst		1	11x30	2998	
TP2	Diagonal support batten - Hilfsleiste - Tasseau - Listelli per rinforzare - Timmerhout - Tugitaud		8	18x90	1200	
EP3	Post - Pfosten - Poteau - Piede registrabile - Stijl - Post		1	90x90	2220	
EP2	Post - Pfosten - Poteau - Piede registrabile - Stijl - Post		1	44x44	2203	
EP1	Post - Pfosten - Poteau - Piede registrabile - Stijl - Post		3	44x44	2260	
RS1	Railing strip - Begrenzungsleiste - Rembarde - Sbarra - Afscheidingslijst - Piirdetaud		2	18x70	1975	
RS2	Railing strip - Begrenzungsleiste - Rembarde - Sbarra - Afscheidingslijst - Piirdetaud		1	18x70	1982	
RS3	Railing strip - Begrenzungsleiste - Rembarde - Sbarra - Afscheidingslijst - Piirdetaud		2	18x70	1993	
RS4	Railing strip - Begrenzungsleiste - Rembarde - Sbarra - Afscheidingslijst - Piirdetaud		1	18x70	2000	
RS5	Railing strip - Begrenzungsleiste - Rembarde - Sbarra - Afscheidingslijst - Piirdetaud		2	18x90	1065	
RS6	Railing strip - Begrenzungsleiste - Rembarde - Sbarra - Afscheidingslijst - Piirdetaud		2	18x90	1075	
RS7	Railing strip - Begrenzungsleiste - Rembarde - Sbarra - Afscheidingslijst - Piirdetaud		1	18x90	2116	
RS8	Railing strip - Begrenzungsleiste - Rembarde - Sbarra - Afscheidingslijst - Piirdetaud		1	18x90	2126	
RS11	Railing strip - Begrenzungsleiste - Rembarde - Sbarra - Afscheidingslijst - Piirdetaud		1	18x90	3039	
RS12	Railing strip - Begrenzungsleiste - Rembarde - Sbarra - Afscheidingslijst - Piirdetaud		1	18x90	3059	
P1	Post - Pfosten - Poteau - Piede registrabile - Stijl - Post		2	88x88	2330	
P2	Post - Pfosten - Poteau - Piede registrabile - Stijl - Post		1	88x88	2223	
P2a	Post - Pfosten - Poteau - Piede registrabile - Stijl - Post		1	88x88	2223	
GL2	Fascia board - Traufbrett - Bandeau de toit - Finitura lati tetto - Gevellijst - Räästataud		4	18x120	2642	
GL1	Fascia board - Traufbrett - Bandeau de toit - Finitura lati tetto - Gevellijst - Räästataud		2	18x120	3379	
DRV-1	Roof edge reinforcement - Dachrandverstärkung - Corniere de renfort de bord de toit - Rinforzo x tetto - Dakrand versterking - Räästatugevdus		4	80x44	2544	
DRV-2	Roof edge reinforcement - Dachrandverstärkung - Corniere de renfort de bord de toit - Rinforzo x tetto - Dakrand versterking - Räästatugevdus		2	80x44	3379	

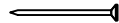
Pos	11.03.2020	Piece list - Stückliste - Liste des pièces - Elementi - Stuklijst - Tükítabel	4/28	Q	P (mm)	L (mm)
FF2	Fixing fillet - Fixierungsleiste - Profil de fixation - Massello di fissaggio - Bevestiging lijstwerk - Tenderliist		1	15x45	2026	
FF9	Fixing fillet - Fixierungsleiste - Profil de fixation - Massello di fissaggio - Bevestiging lijstwerk - Tenderliist		2	18x44	1967	
FF	Fixing fillet - Fixierungsleiste - Profil de fixation - Massello di fissaggio - Bevestiging lijstwerk - Tenderliist		5	18x44	2030	
FF3	Fixing fillet - Fixierungsleiste - Profil de fixation - Massello di fissaggio - Bevestiging lijstwerk - Tenderliist		1	38x46	1980	
FF4	Fixing fillet - Fixierungsleiste - Profil de fixation - Massello di fissaggio - Bevestiging lijstwerk - Tenderliist		3	38x46	2026	
FF7	Fixing fillet - Fixierungsleiste - Profil de fixation - Massello di fissaggio - Bevestiging lijstwerk - Tenderliist		1	38x46	2998	
HS8	Screw for corner fillet - Schraube zur Befestigung deckleiste - Vis pour profils de finition angles a l'exterieur - Viti per massellino d'angolo - Schroef voor afdekljst (hoek) - Krugi nurgaliistudele		6	3.5x35		
HS32	Screw for door jamb - Schraube für Türrahmen - Vis de fixation partie haute avec montants du cadre de porte - Viti x fissaggio montanti porte - Schroef voor deurkozijn - Krugi ukse lengite		12	4x25		
HS14	Screw for wall details - Schraube für wand details - Vis pour mur details - Viti per elementi della porta - Schroef voor wand details - Krugi seinte montaažiks		331	4.5x80		
HS12	Screw for doorstep - Schrauben für swelle - Vis pour fixation barre de seuil - Vite per soglia della porta - Schroef voor deurdoorpel - Krugi tävepakute		7	4x40		
HS12	Screw for metal corner - Holzschraube für metallwinkel - Vis de fixation des cornieres en metal - Viti per fissare suadretta di metallo di giunzione - Schroef voor metalen hoek - Krugi nurgikute		50	4x40		
HS12	Screw for diagonal support batten - Schraube für dachlatte - Vis de tasseau - Vite per listelli per rinforzare - Schroef voor timmerhout - Krugi tugilauate		24	4x40		
HS12	Screw for diagonal support batten - Schraube für dachlatte - Vis de tasseau - Vite per listelli per rinforzare - Schroef voor timmerhout - Krugi tugilauate		16	4x40		
HS12	Screw for fascia boards - Schrauben für traufbretter - Vis pour fixation bandeau de toit - Viti x striscia del tetto - Schroef voor gevellijst - Krugi räästalauate		34	4x40		
HS12	Screw for beam holder - Schrauben für balkenhalter - Vis de fixation support "u" galvanisé - Vite per trave di sostegno - Schroef voor bevestiging balkhouder (gordingschoen) - Krugi tatakigate		120	4x40		
HS12	Screw for fixing fillet of door and window - Schrauben für fixierungsleiste - Vis pour profil vertical de fixation pour ouvertures des fenetres et portes - Viti per massello di fissaggio - Schroeven voor bevestiging van deur en raam lijsten - Krugi tenderliistudele		90	4x40		
HS12	Screw for covering moulding - Schrauben für deckungsprofil - Vis de fixation profils horizontaux haut interieur et exterieur d'encadrement de porte - Vite per cornice di copertura - Schroef voor afdekprofiel - Krugi piirdelauate		64	4x40		
HS12	Screw for door jamb - Schraube für Türrahmen - Vis de fixation partie haute avec montants du cadre de porte - Viti x fissaggio montanti porte - Schroef voor deurkozijn - Krugi ukse lengite		18	4x40		
HS18	Screw for roof beams - Schrauben für dachbalken - Vis pour fixation pannes de toit - Viti per pertine del tetto - Schroef voor gordingen / dakbalken - Krugi pärtimitele		5	5x120		
HS33	Screw for door jamb - Schraube für Türrahmen - Vis de fixation partie haute avec montants du cadre de porte - Viti x fissaggio montanti porte - Schroef voor deurkozijn - Krugi ukse lengite		20	5x40		
HS16	Screw for foundation - Schrauben zur Befestigung fundament - Vis de fixations des poutrelles de fondations - Viti x fondamenta - Schroef voor fundering - Krugi alusraamite		16	5x90		
HS16	Screw for post - Schrauben für pfosten - Vis de fixation des poteaux - Viti per inviare - Schroef voor stijlen - Krugi postite		16	5x90		
HS16	Screw for roof edge reinforcement - Schrauben für Dachrandverstärkung - Vis pour fixation corniere renfort de bord de toit - Viti x rinforzo bordo tetto - Schroef voor dakrand versterking - Krugi räästatugevdusele		34	5x90		

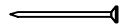
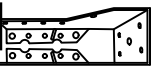
Pos	11.03.2020	Piece list - Stückliste - Liste des pièces - Elementi - Stuklijst - Tükítabel	5/28	Q	P (mm)	L (mm)
		Art.Nr. 4423819				
HS16		Screw for wall details - Schraube für wand details - Vis pour mur details - Viti per elementi della porta - Schroef voor wand details - Kruvi seinadetailidete		11	5x90	
HS16		Screw for foundation - Schrauben zur befestigung fundament - Vis de fixations des poutrelles de fondations - Viti x fondamenta - Schroef voor fundering - Kruvi alusraamite		12	5x90	
HS16		Screw for door jamb - Schraube für türrahmen - Vis de fixation partie haute avec montants du cadre de porte - Viti x fissaggio montanti porte - Schroef voor deurkozijn - Kruvi ukse lengite		18	5x90	
HS22		Screw for 1. wall beam - Schraube für 1. bohlenreihe - Vis de fixations 1ere rangée de madriers avec poutrelles de fondations - Vite fissaggio alle fondamenta - Schroef voor 1 wandbalk - Kruvi poollauate		12	6x150	
HS23		Screw for wall details - Schraube für wand details - Vis pour mur details - Viti per elementi della porta - Schroef voor wand details - Kruvi seinadetailidete		155	6x180	
HS21		Screw for roof lath - Schraube für dachlatte - Vis pour latte - Vite per listello del tetto - Schroef voor daklat - Kruvi roovite		10	6x80	
NF2		Zn nail for floor fillet - Zn nägel für fussbodenteiste - Pointe pour corniere de finition du plancher - Chiodi x fissaggio pavimento - Spijker(nagel) voor vloer afdekljst - Nael põrandaliistule		45	1.4x40	
SH44		Hammer block - Schlagholz - Calle de frappe - Blocco di legno da usare come cuscinetto quando si usa il martello - Stagktos - Löögiktots		1		
NF4		Zn nail for roof - Zn nägel für dachbretter - Pointe pour fixation voliges de toit - Chiodi x pertine tetto - Spijker(nagel) voor dakhout - Nael katusetauate		798	2x50	
NF4		Zn nail for floor - Zn nägel für fussbodenbretter - Clous pour plancher - Chiodi x pertine pavimento - Spijker(nagel) voor vloer - Nael põrandatauate		342	2x50	
MW		Metal corner - Metallwinkel - Corniere en métal - Angolo di metallo - Metalen hoek - Nurgik		4	120x80x40	
NF5		Zn nail for roofing felt fillet - Zn nägel für dachpappenleiste - Pointe pour baguette de fixation feutre bitumeux - Chiodi x carta bituminosa x tetto - Spijker(nagel) voor asfaltpapier afdekljst - Papiiistunael		26	2x40	
BM		Beam holder - Balkenhalter - Support en u galvanisé - Supporto della trave - Balkendrager (gording schoen) - Talaking		10	70x125	
		Door - Tür - Porte - Porte - Deur - Uks				
		835x1957 UL 2.10.1V R MM TP+		1		

Pos	11.03.2020	Piece list - Stückliste - Liste des pièces - Elementi - Stuklijst - Tükítabel	6/28	Q	P (mm)	L (mm)
		Art.Nr. 4423819				
P2a	Post - Pfosten - Poteau - Piede registrabile - Stijl - Post			1	88x88	2223

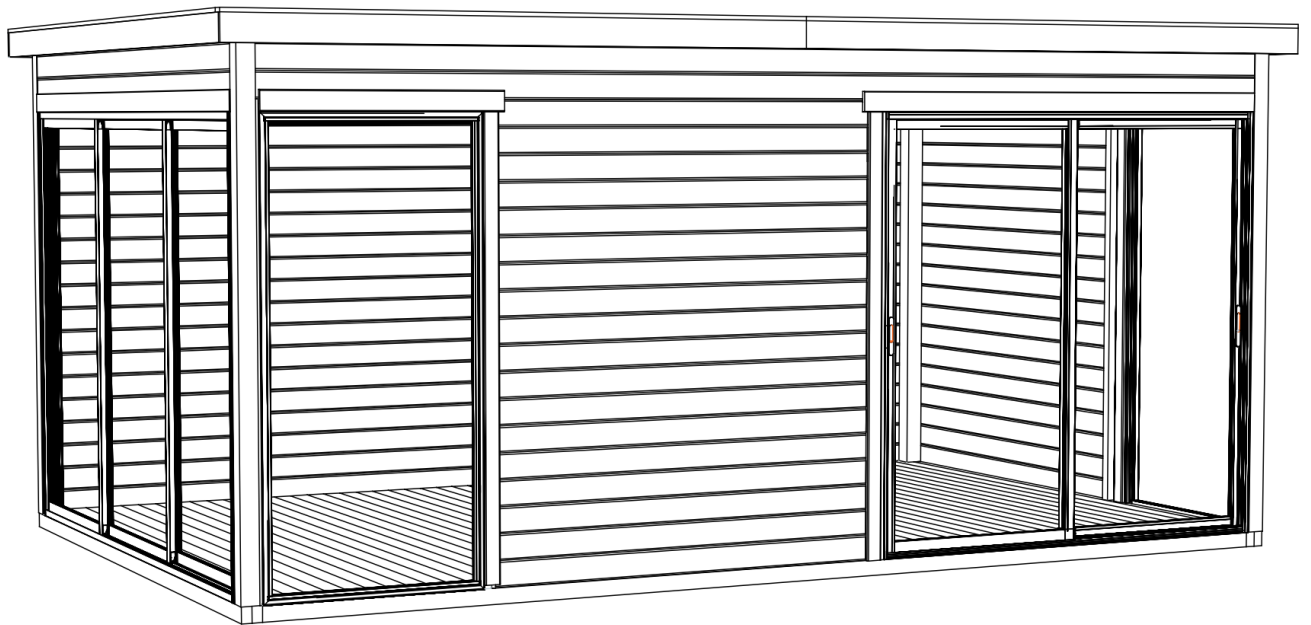











Art. Nr. 4423819

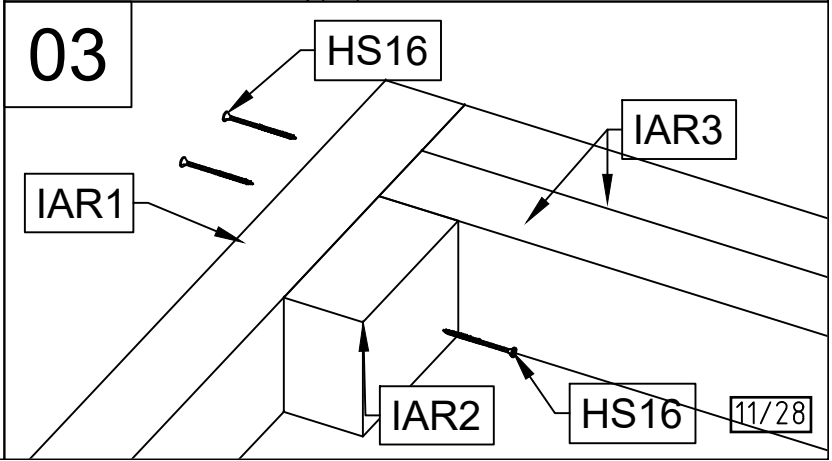
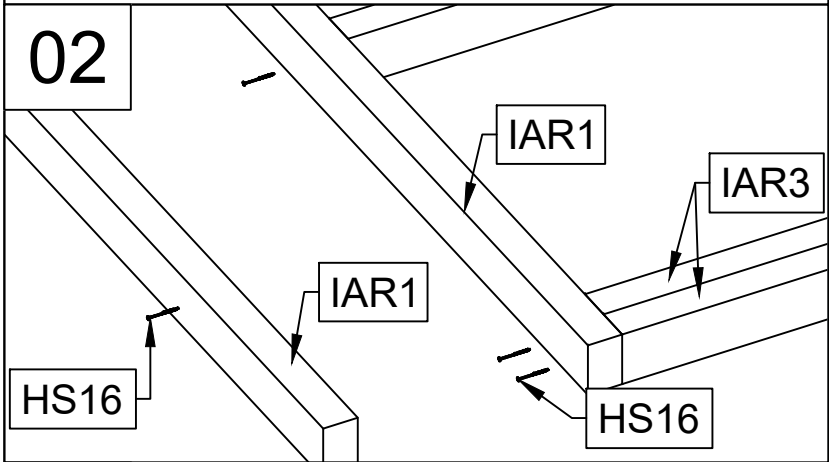
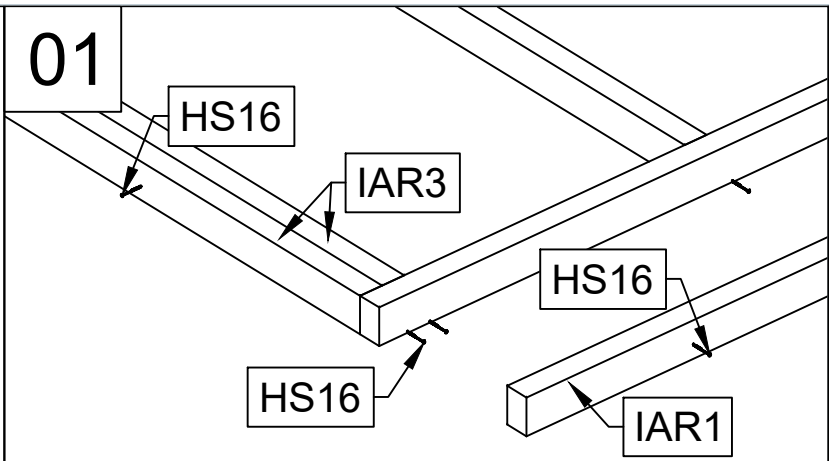
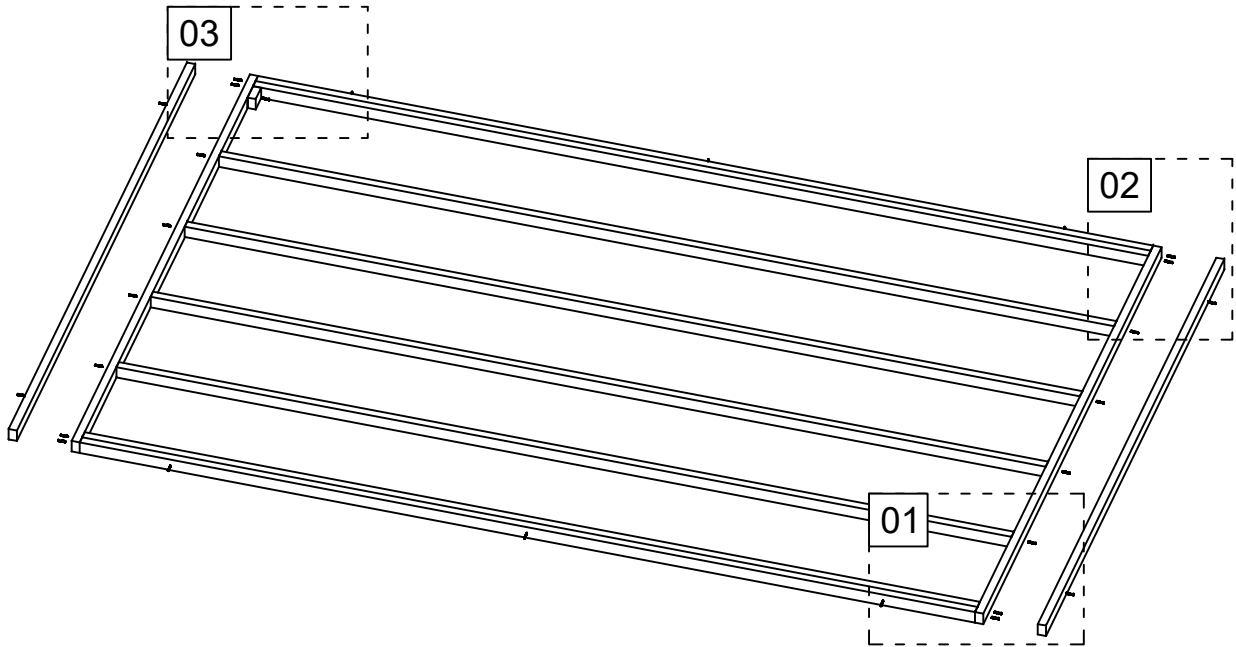

11.03.2020

11/28

Art. Nr. 4423819

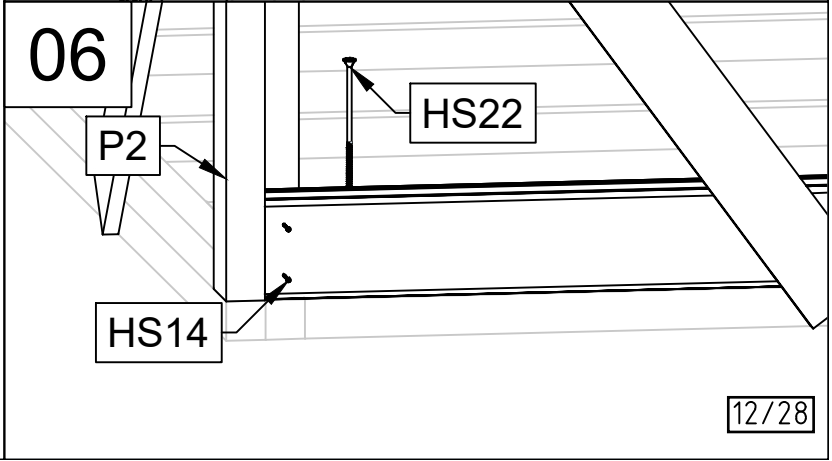
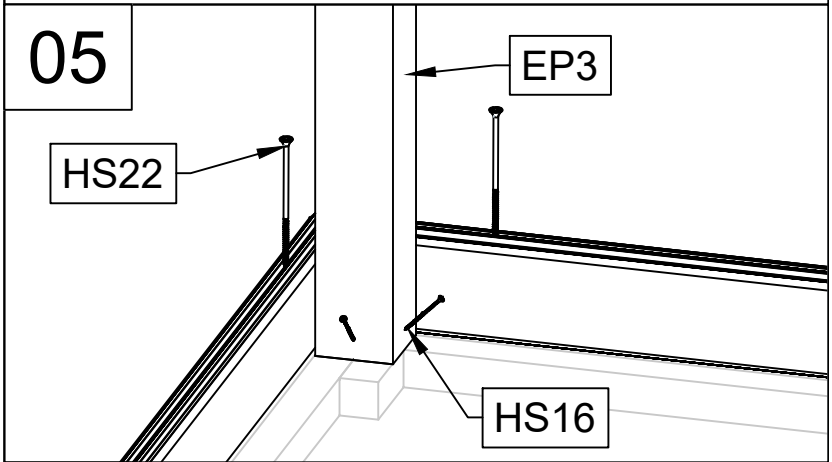
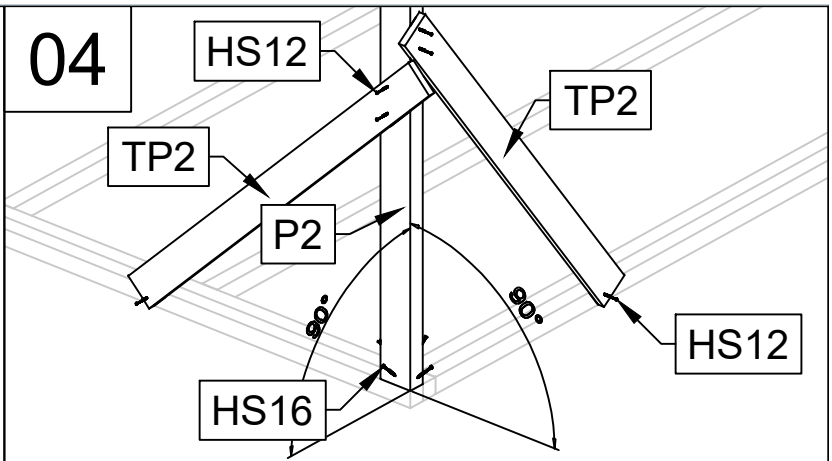
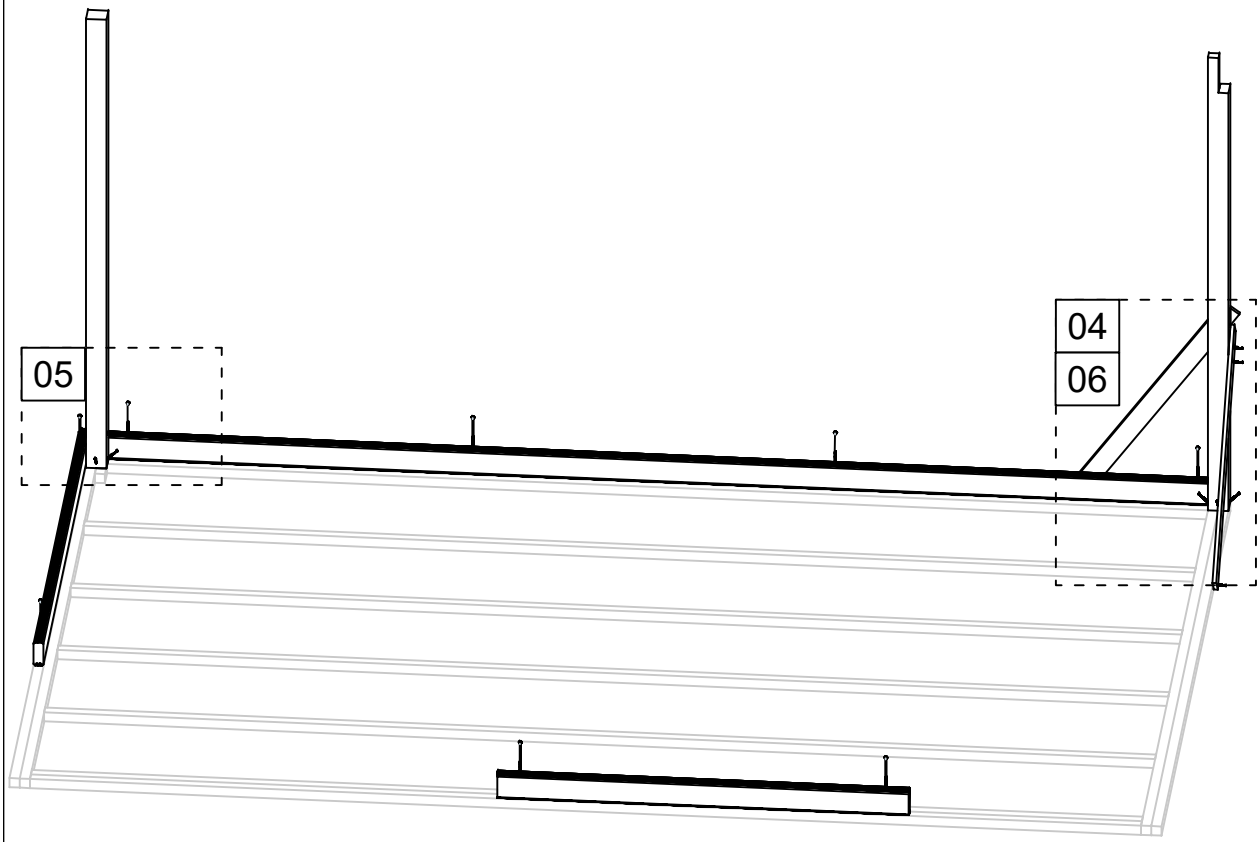

11.03.2020

Art. Nr. 4423819

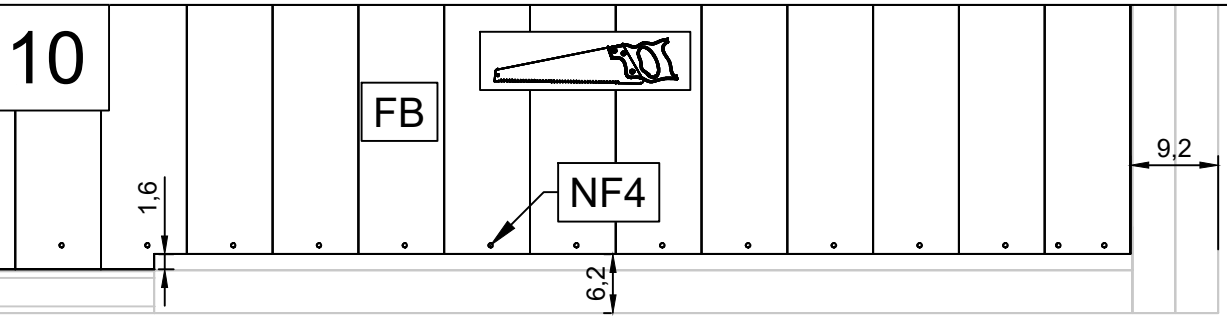
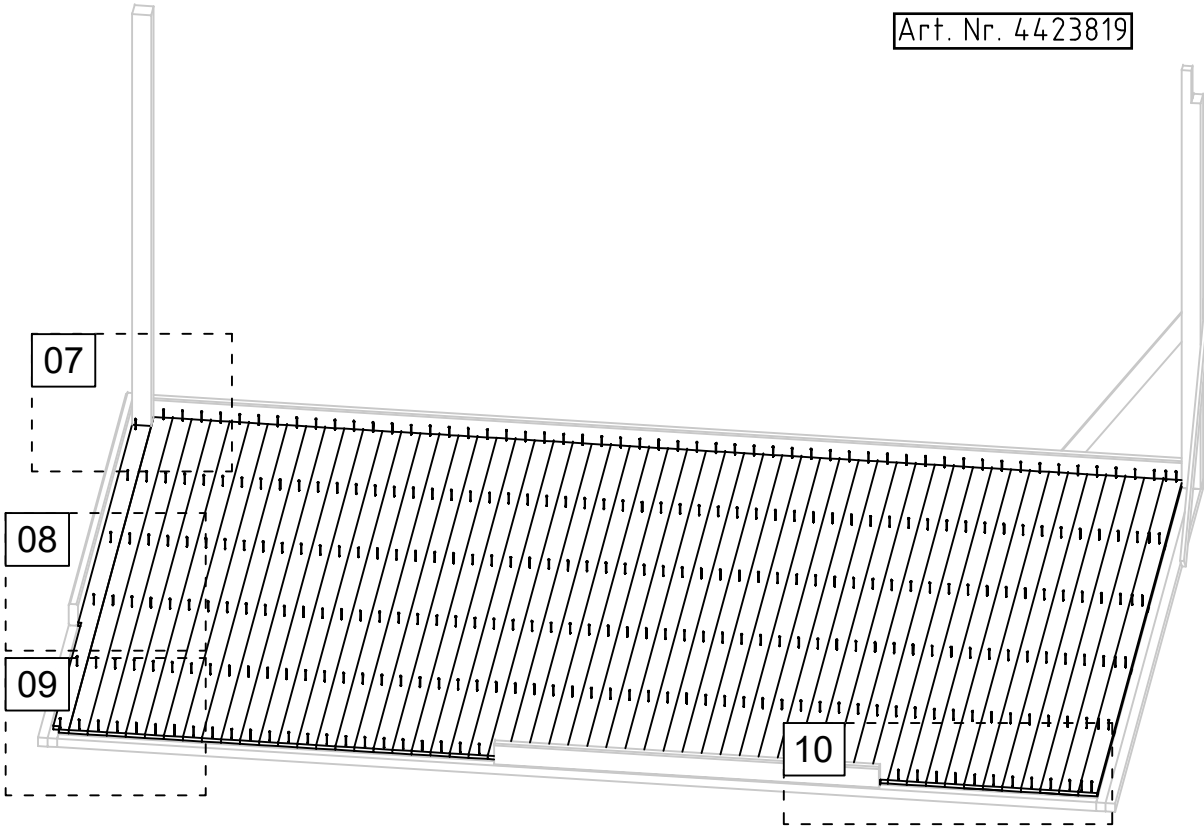

11.03.2020

07

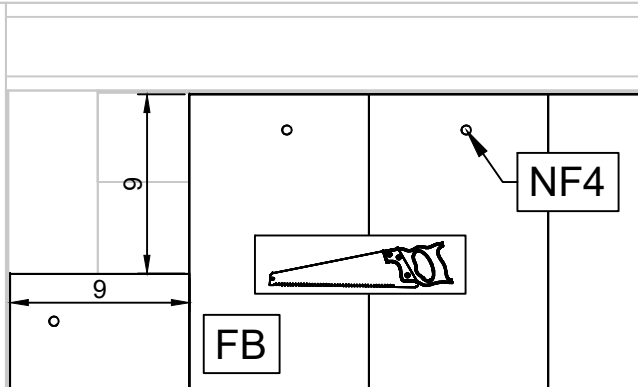

08

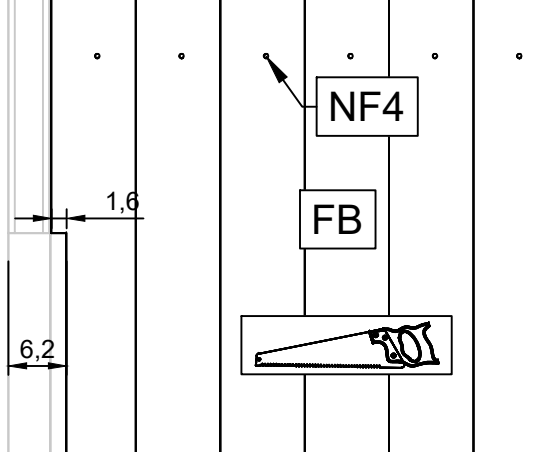

09

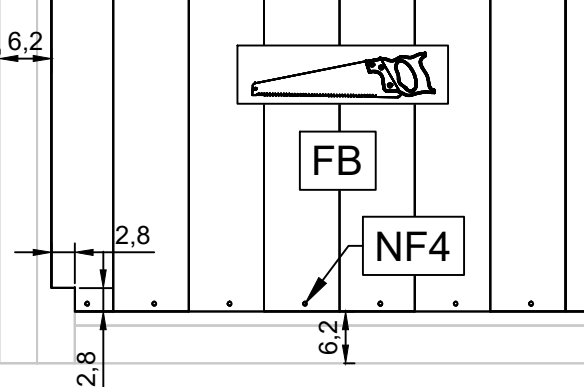

13/28

Art. Nr. 4423819

11

12

11

HS23

HS14

12

HS23

HS14

11

EP1

HS23

HS14

11.03.2020

14/28

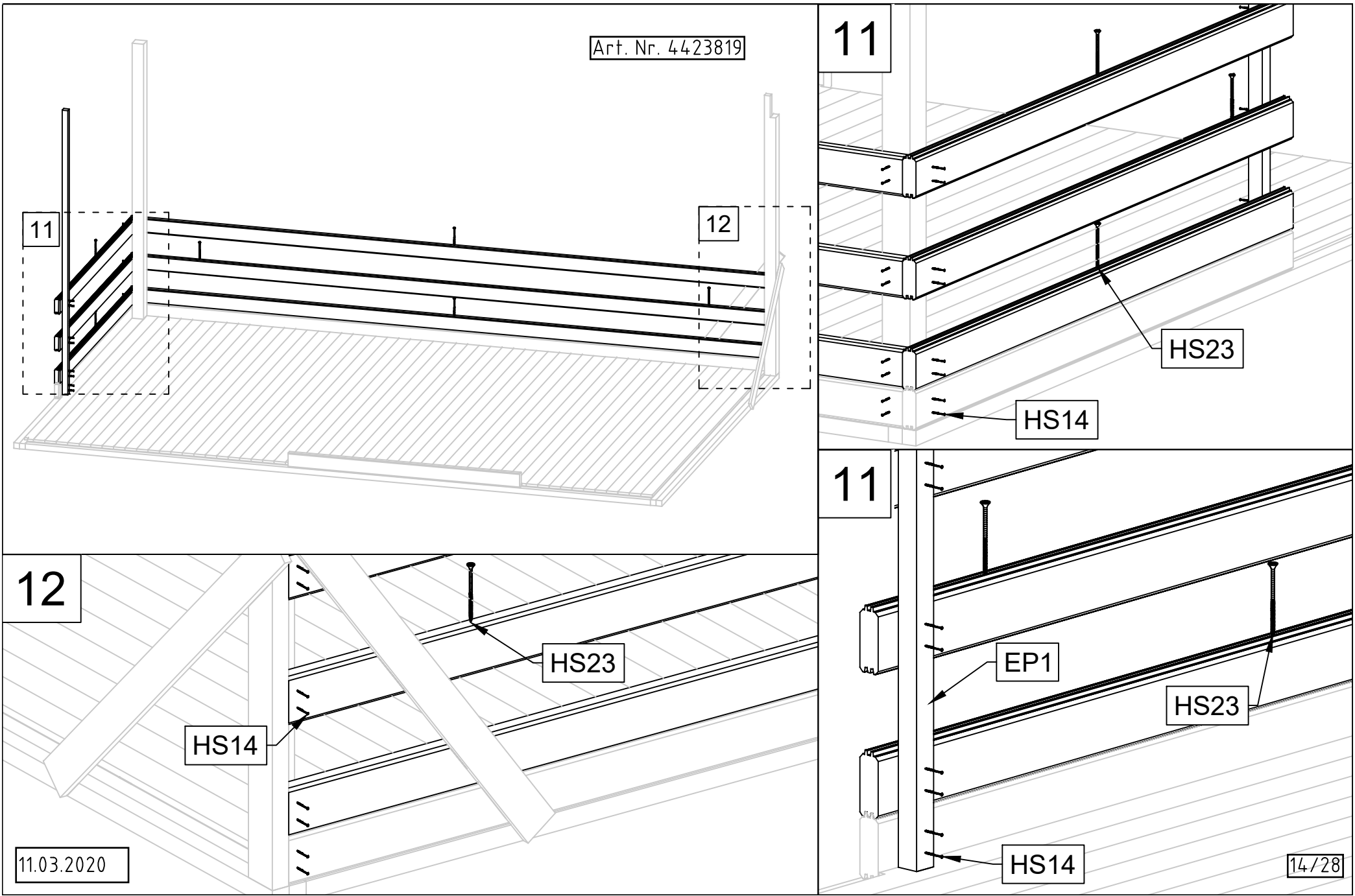

Art. Nr. 4423819

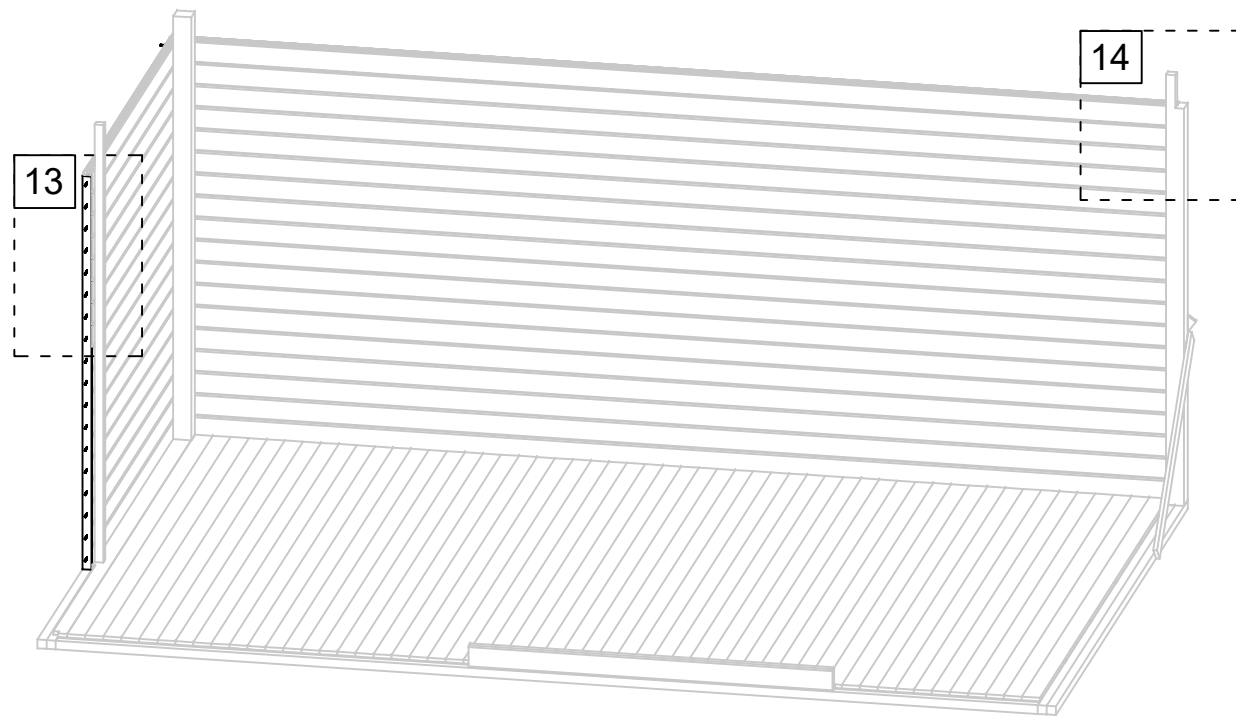

13

14

11.03.2020

13

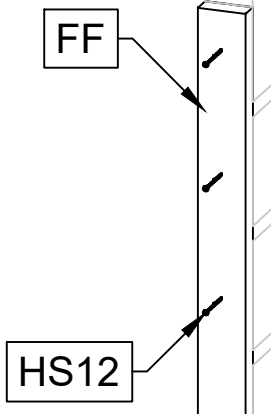

14

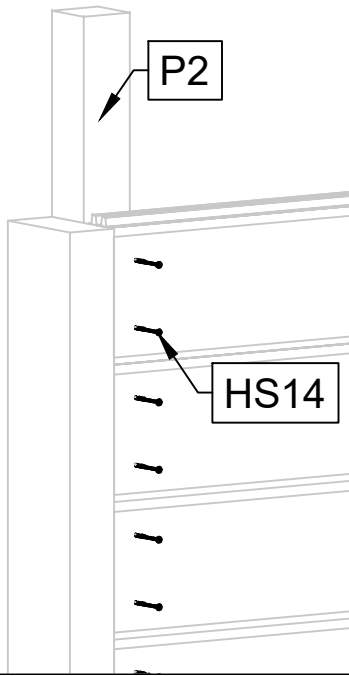

Art. Nr. 4423819

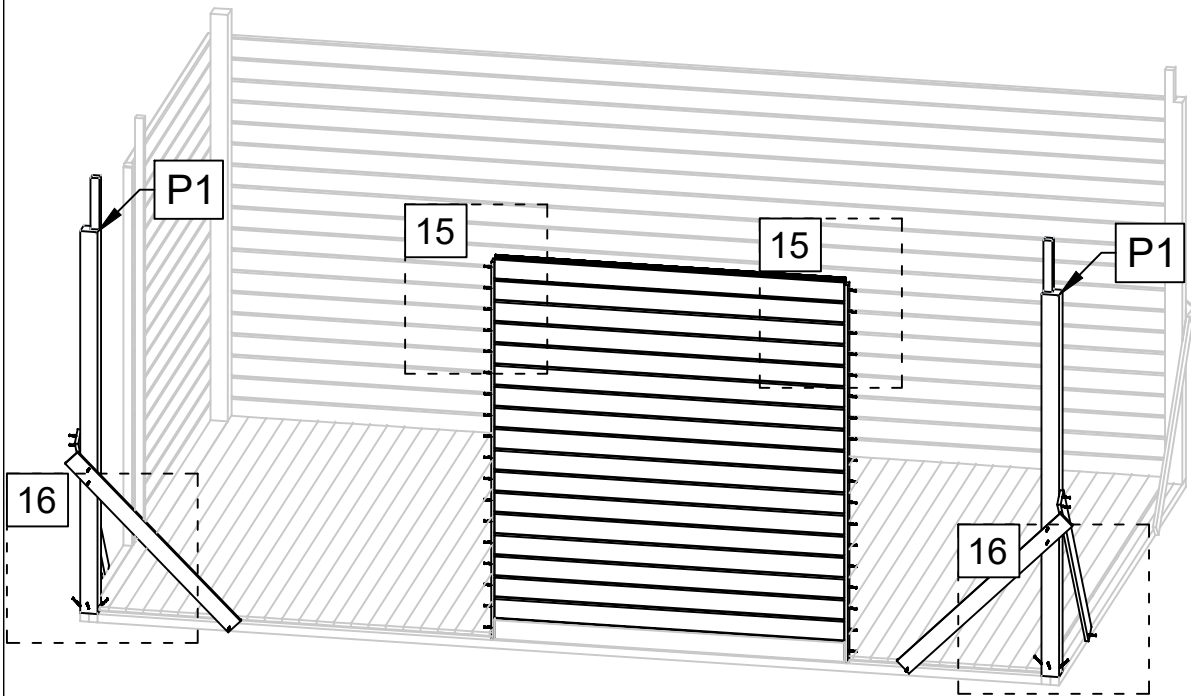

11.03.2020

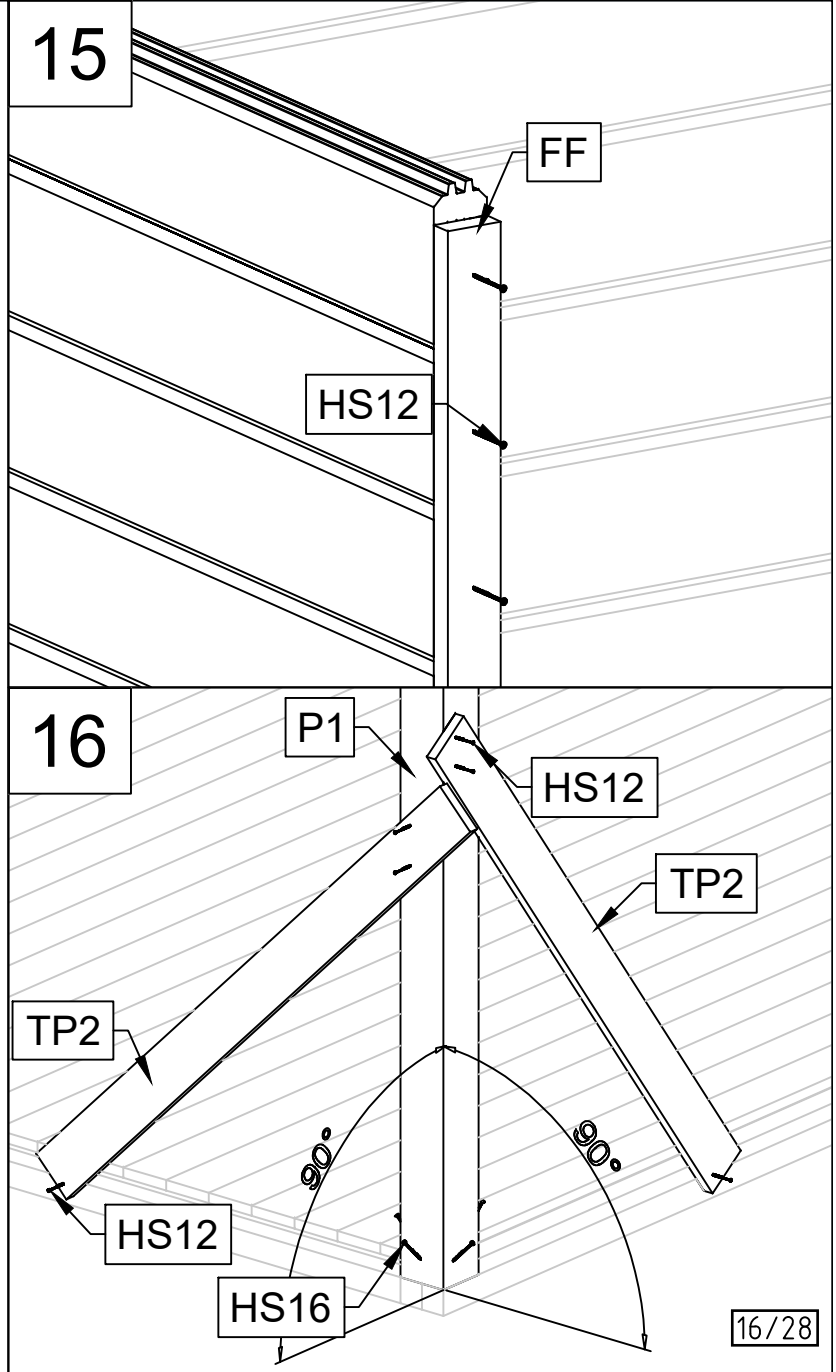

16/28



Art. Nr. 4423819

17

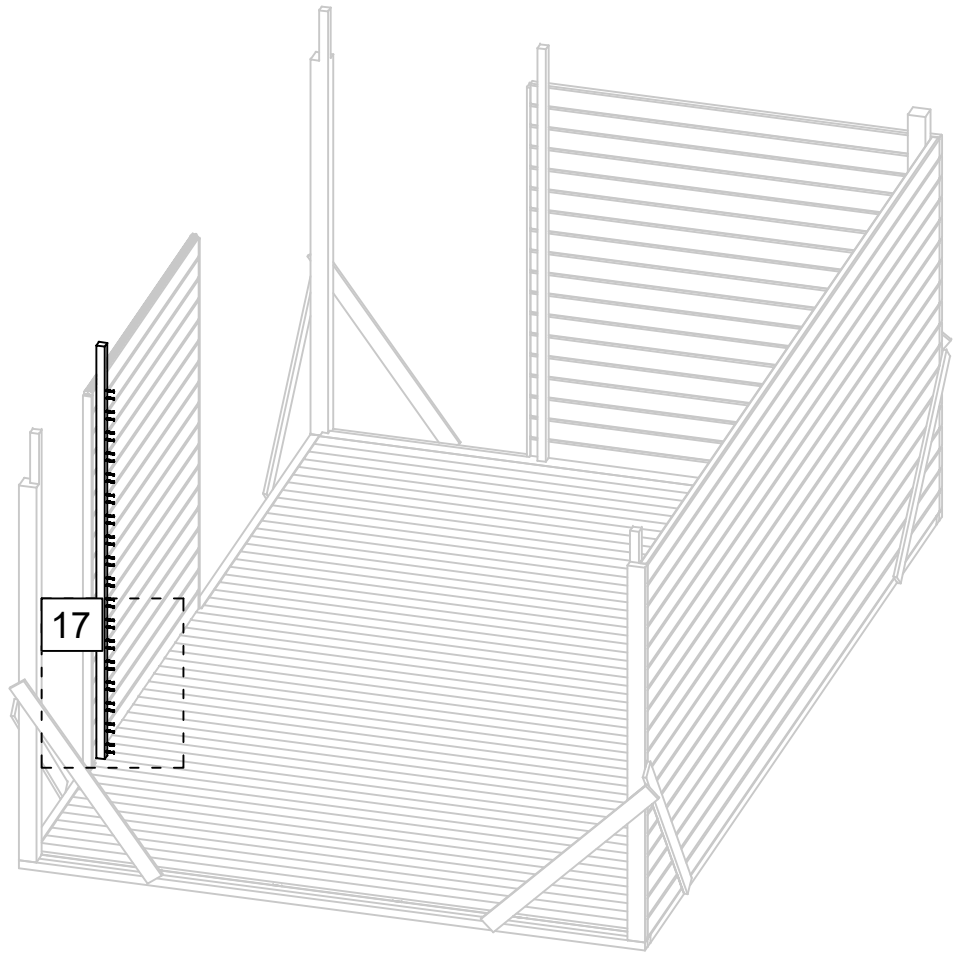

17

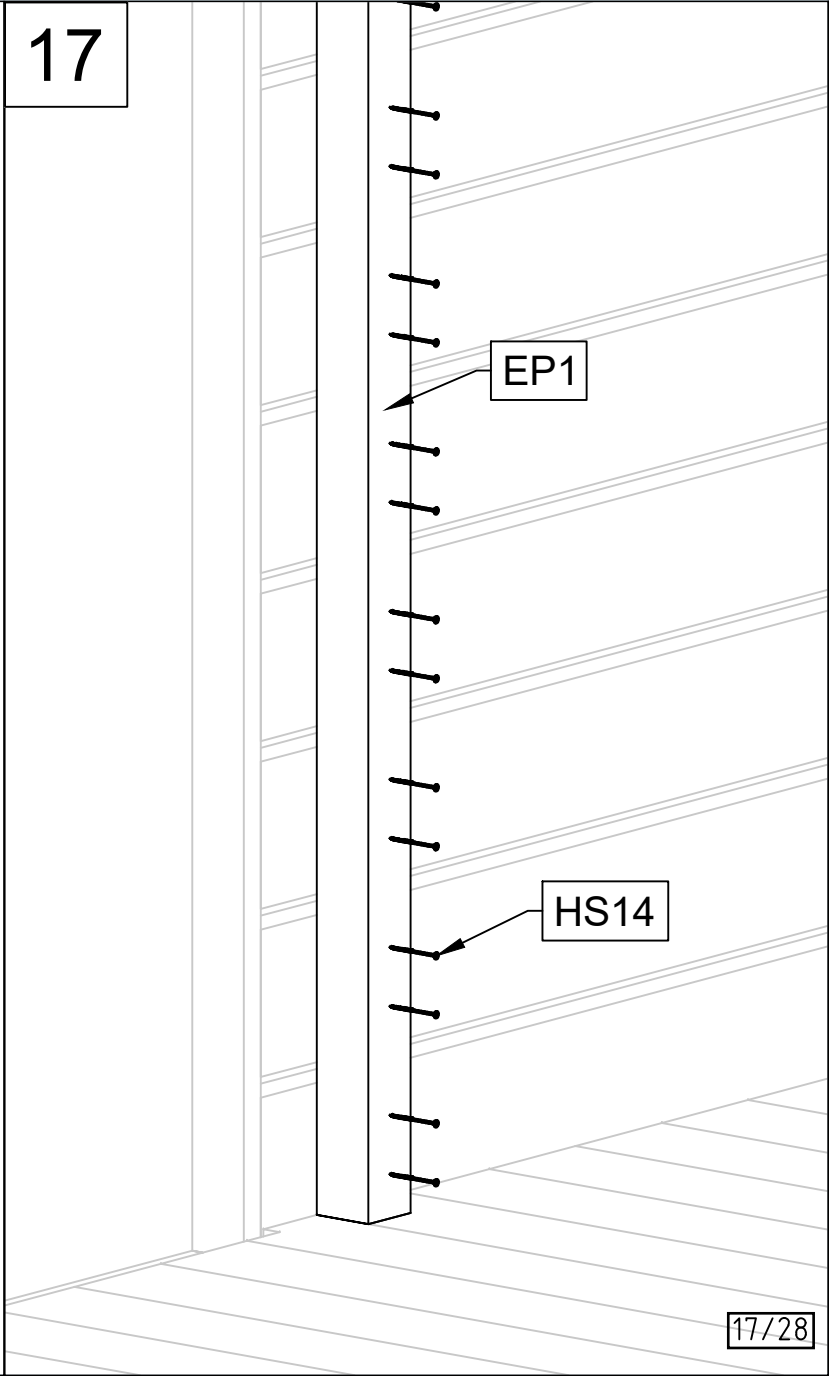

EP1

HS14

11.03.2020

17/28

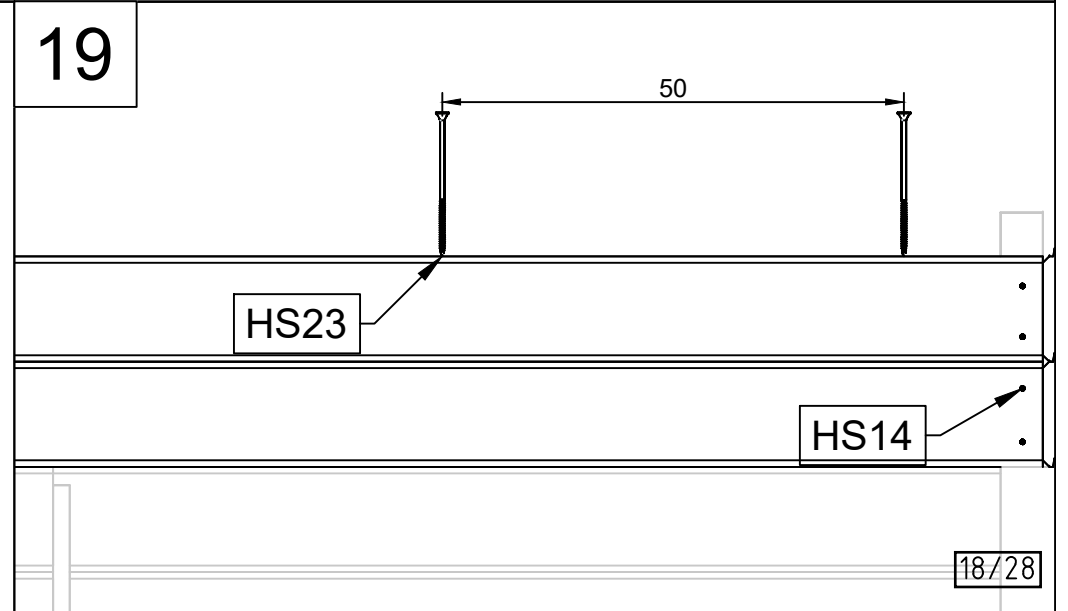
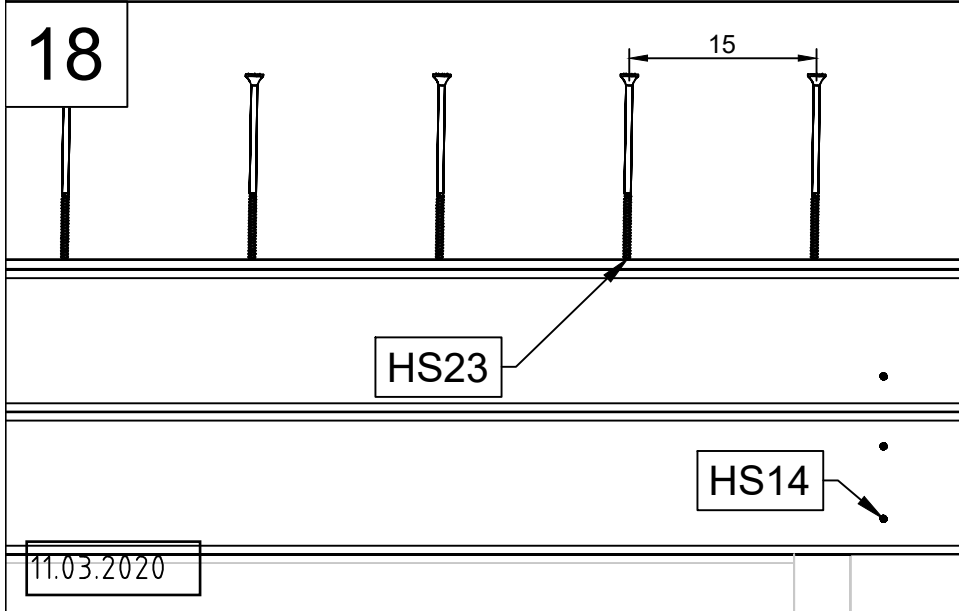
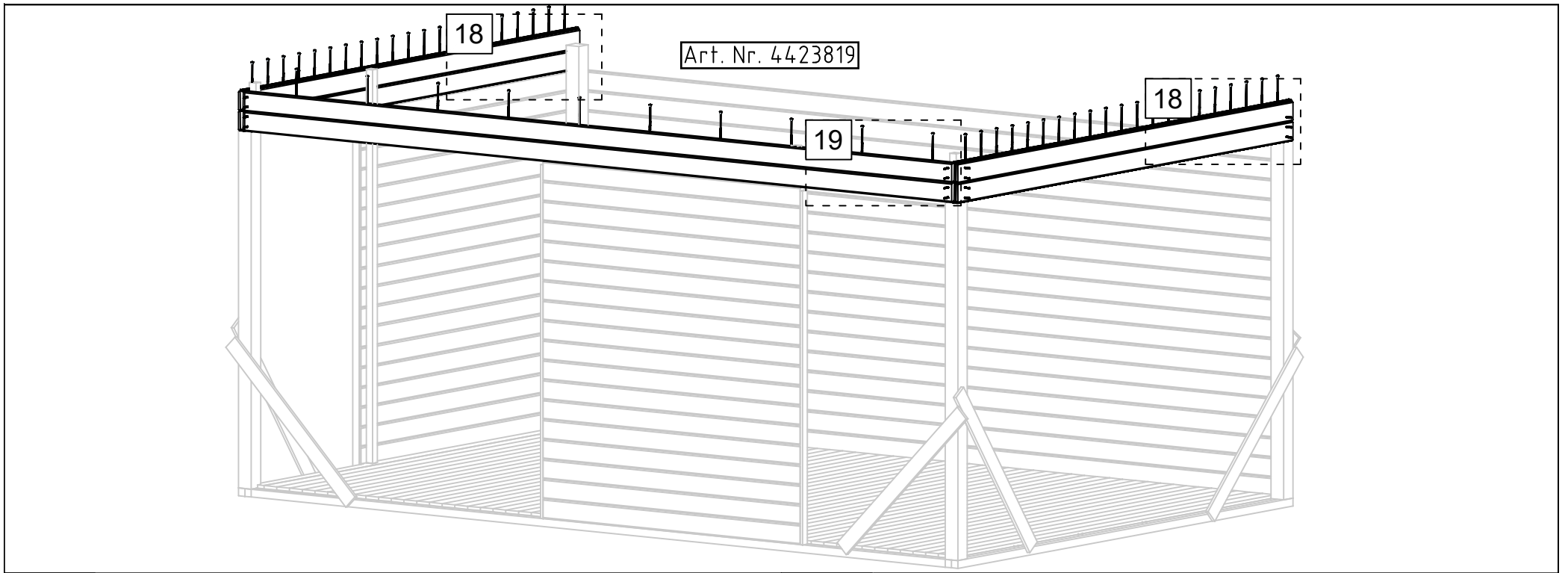

Art. Nr. 4423819

20

20

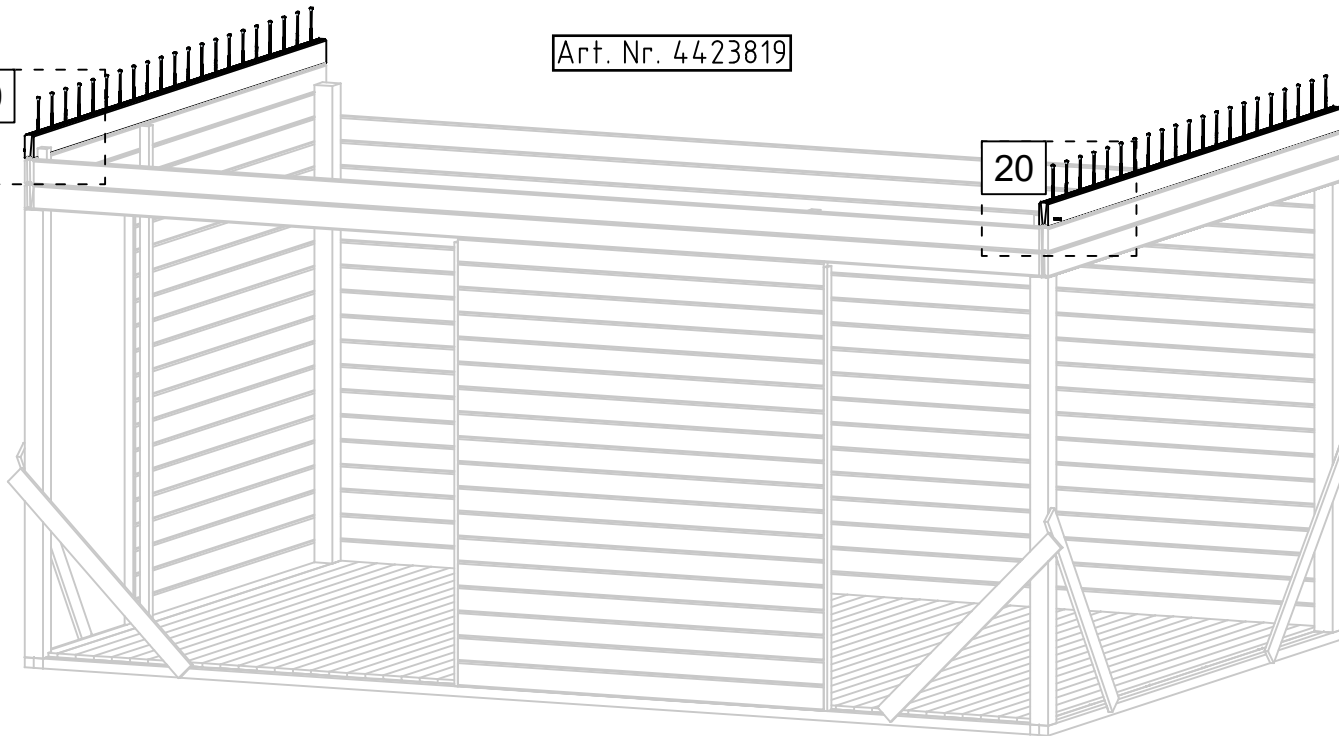

20

15

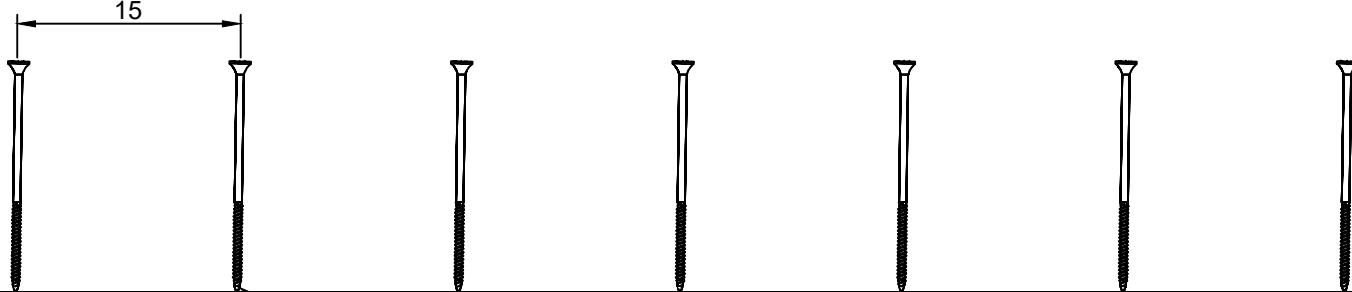

HS14

HS23

11.03.2020

19/28

Art. Nr. 4423819

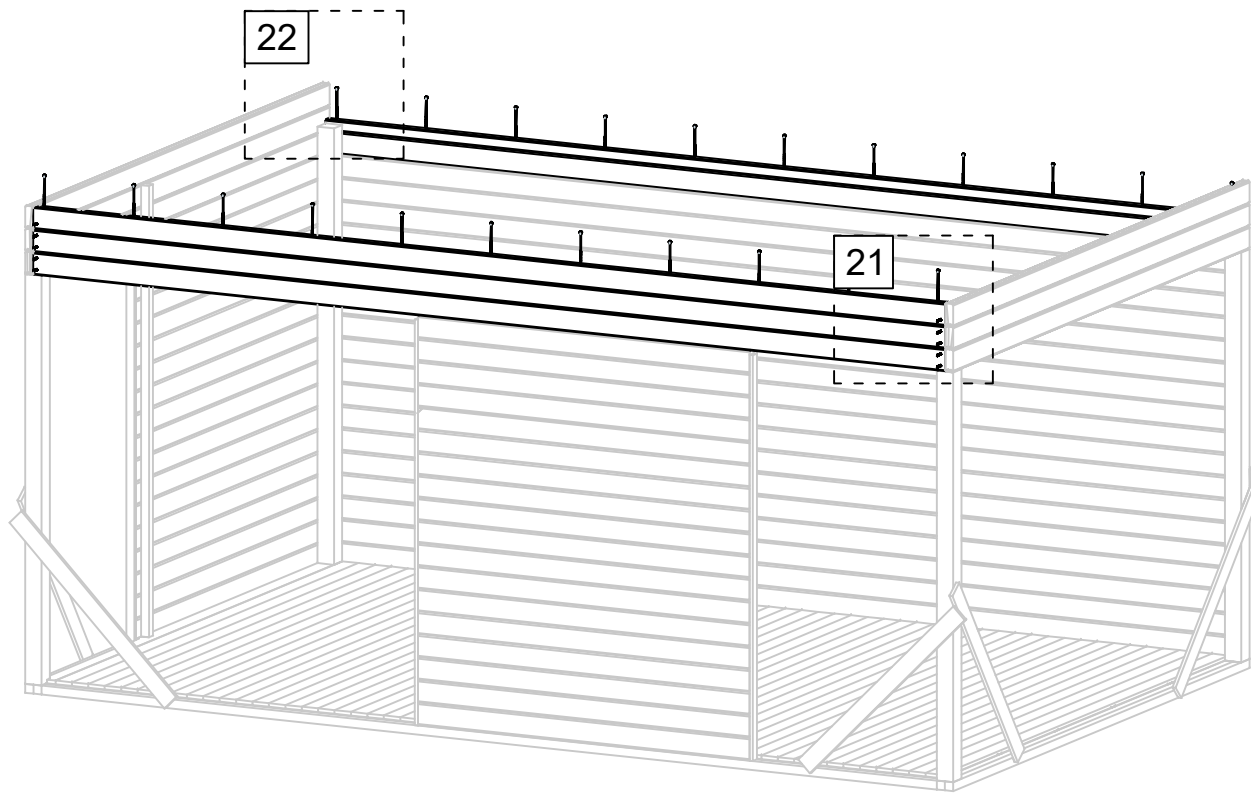

21

HS23

50

HS14

22

50

HS16

HS14

11.03.2020

20/28

Art. Nr. 4423819

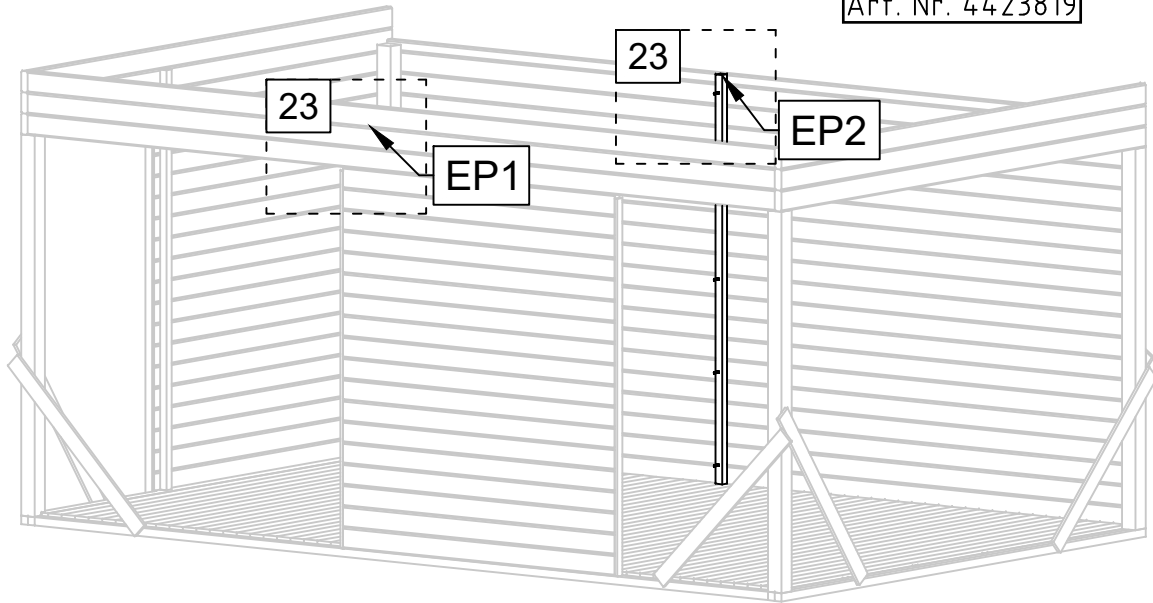

23

Min 223.4 cm -  
Max 383.4 cm

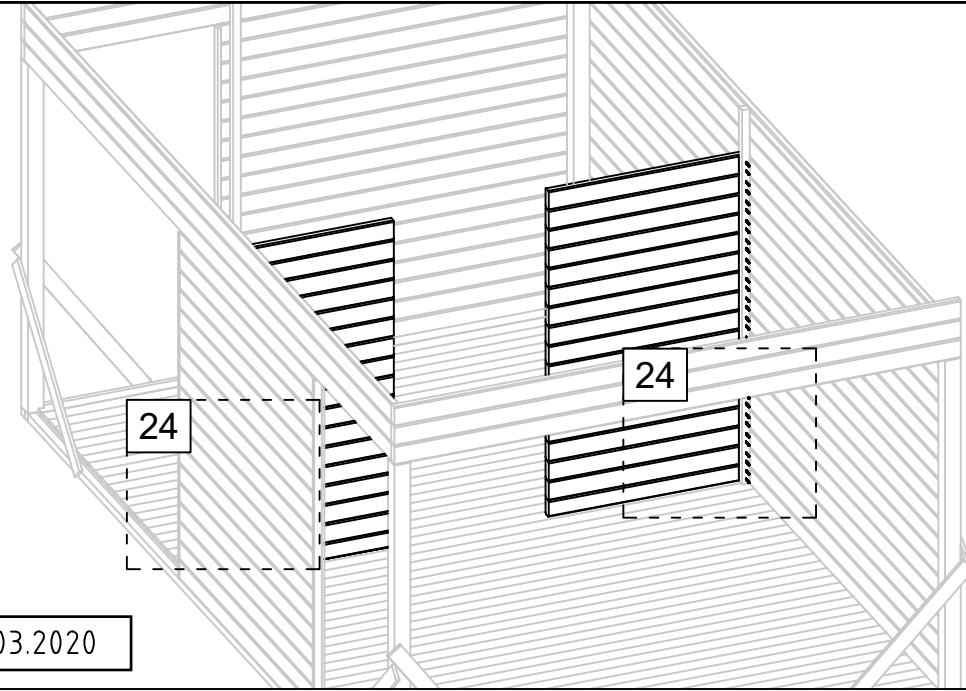
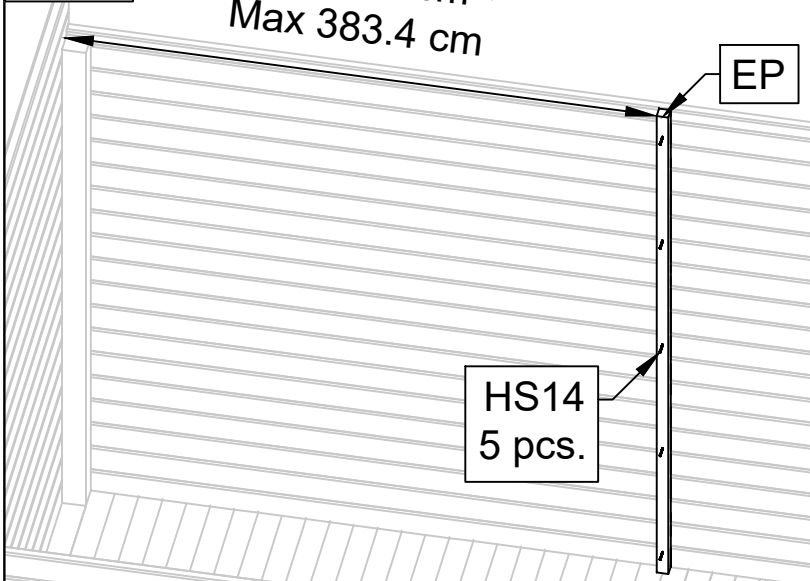

24

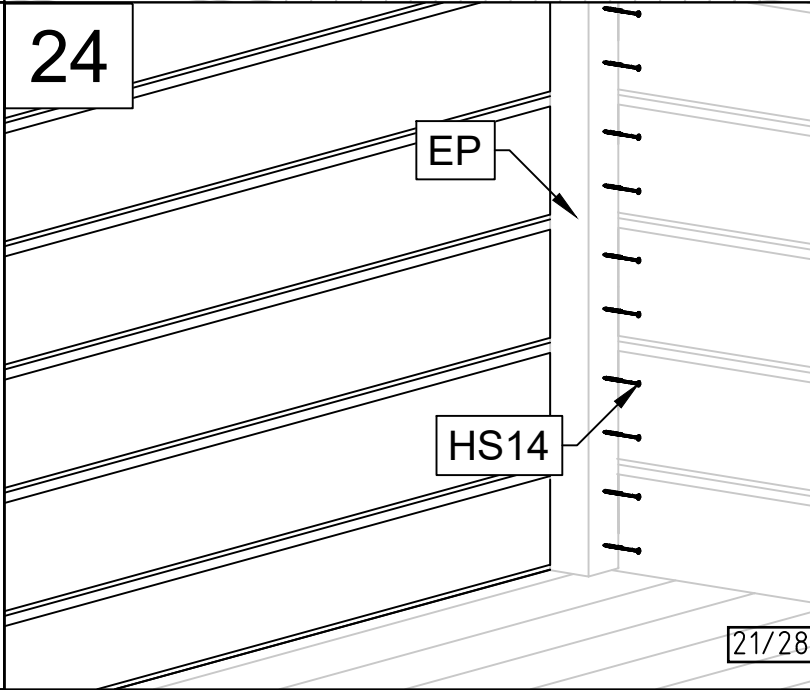

11.03.2020

21/28

Art. Nr. 4423819

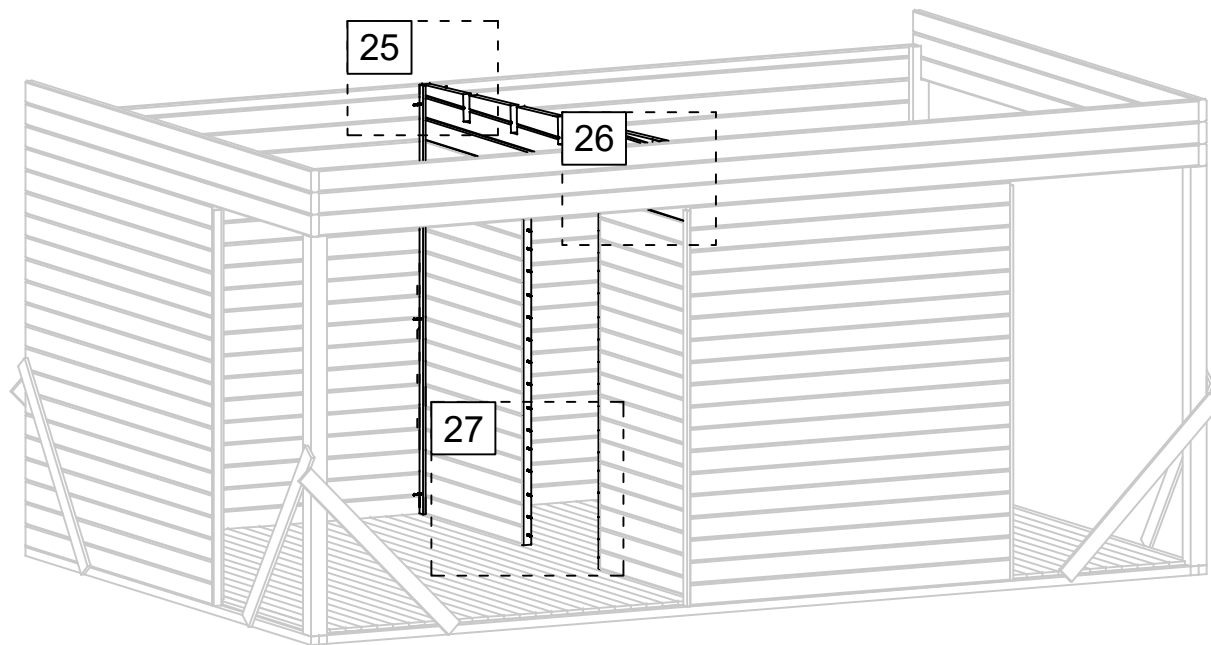

25

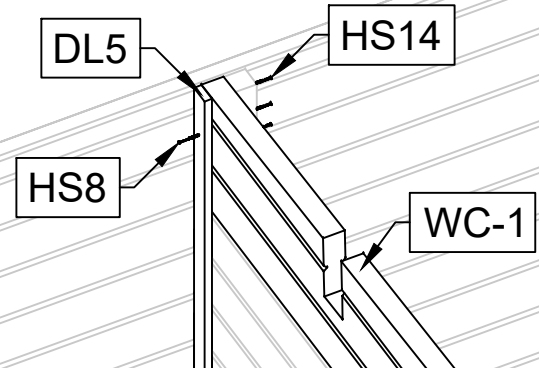

26

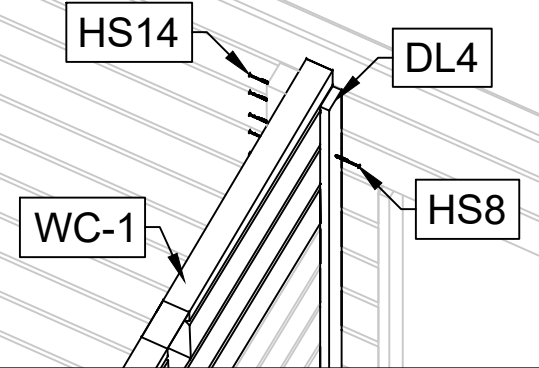

27

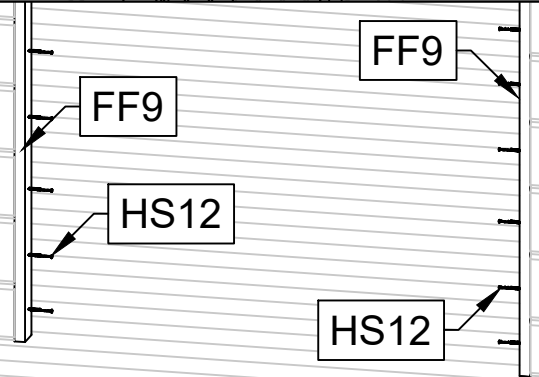

11.03.2020

Art. Nr. 4423819

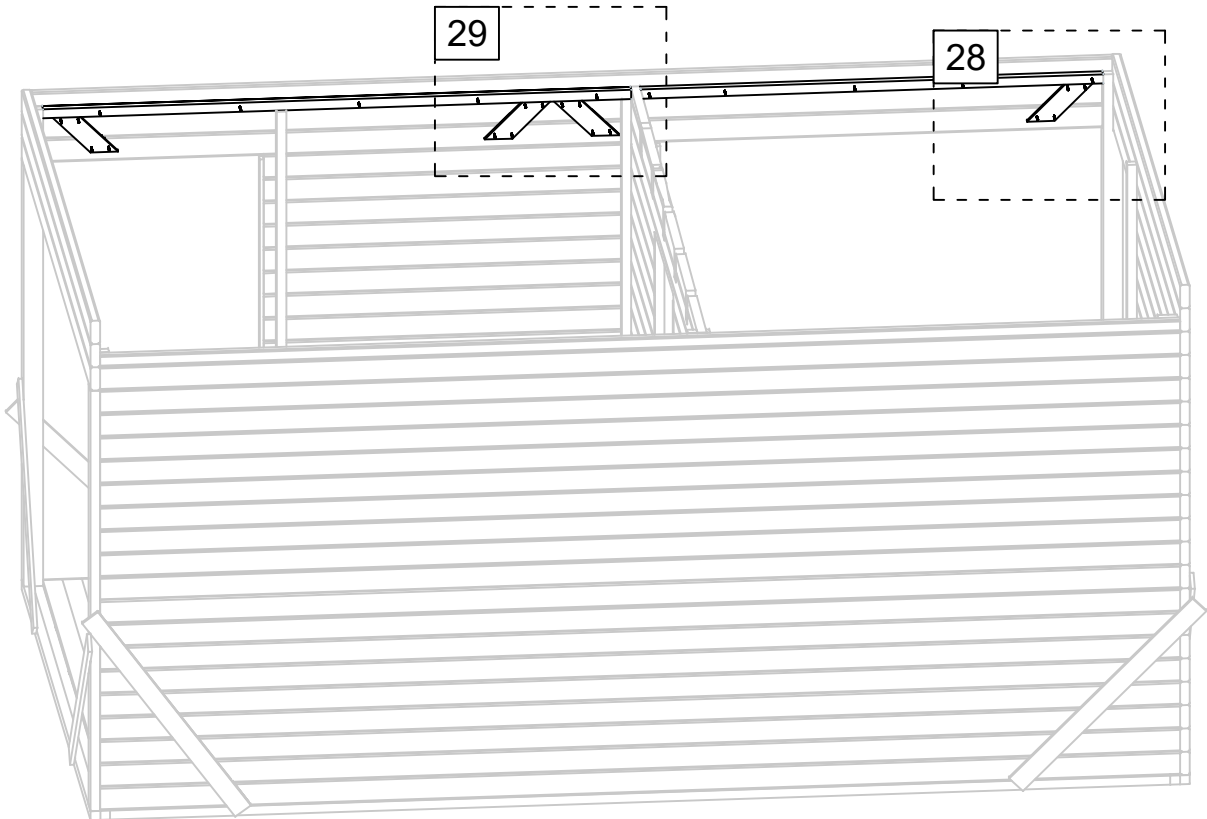

28

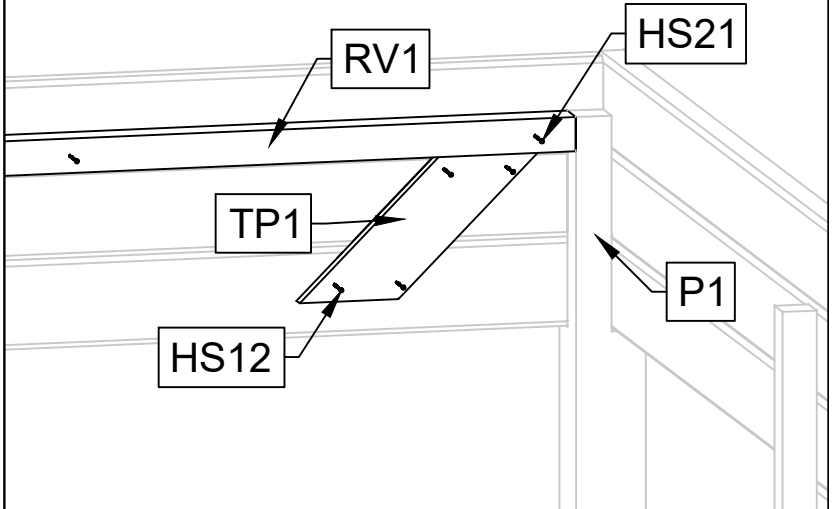

29

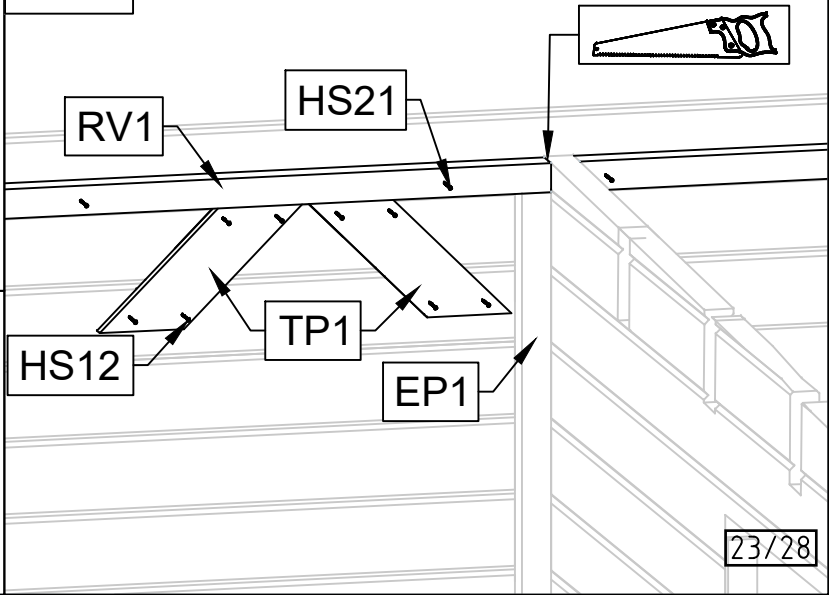

11.03.2020

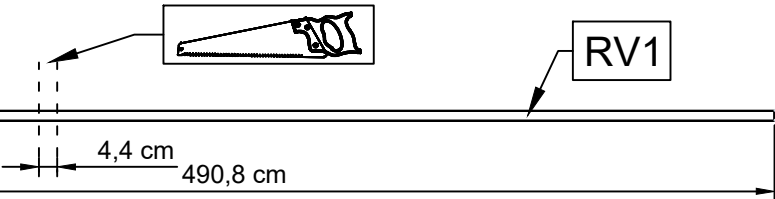

23/28

Art. Nr. 4423819

30

≈1.5cm

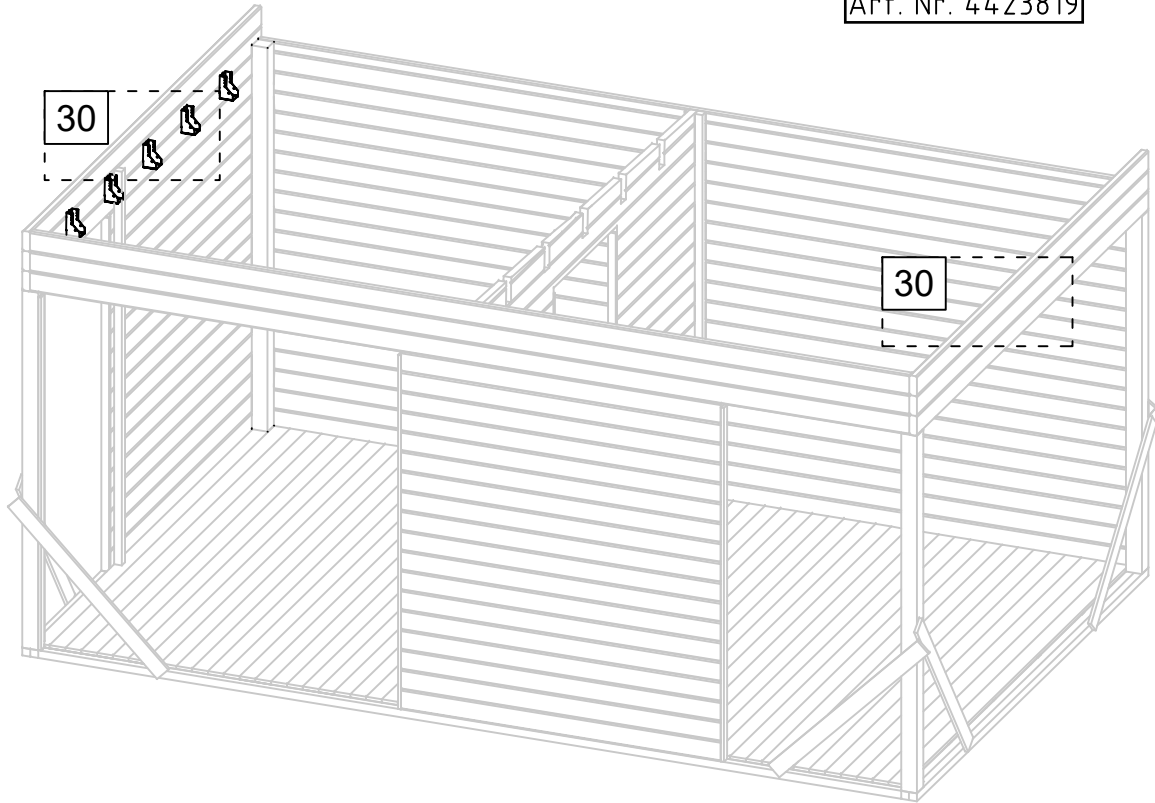

BM

HS12

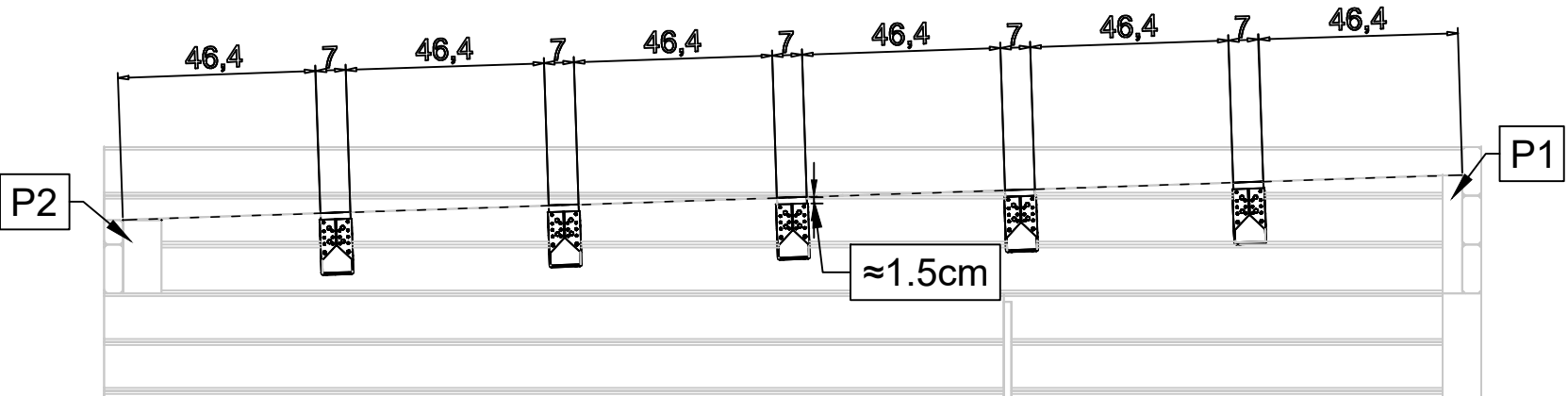
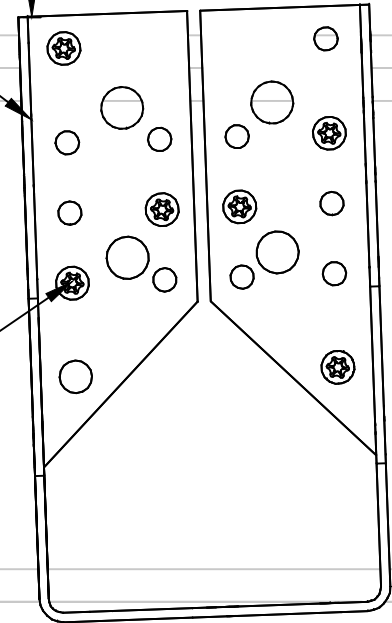



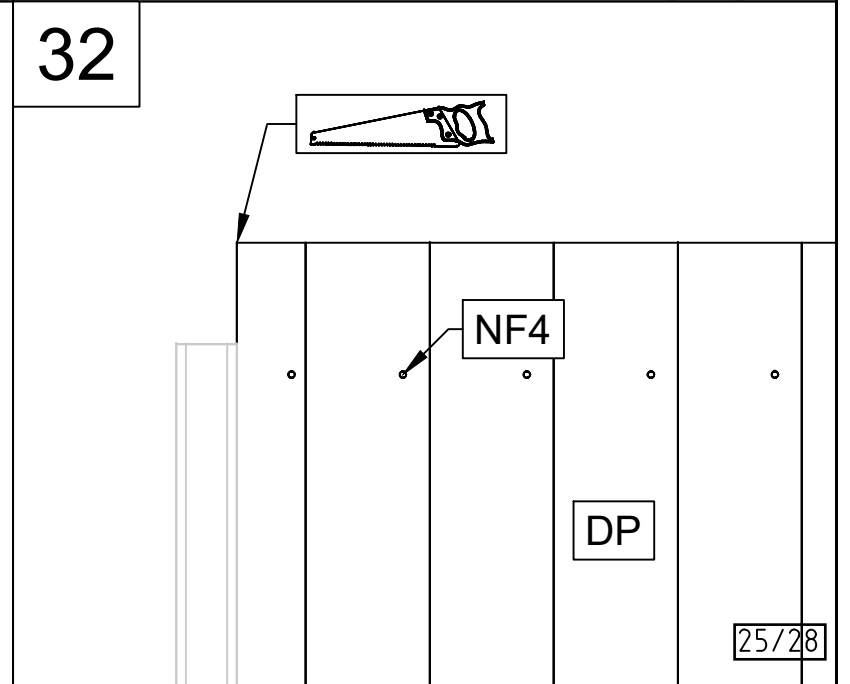
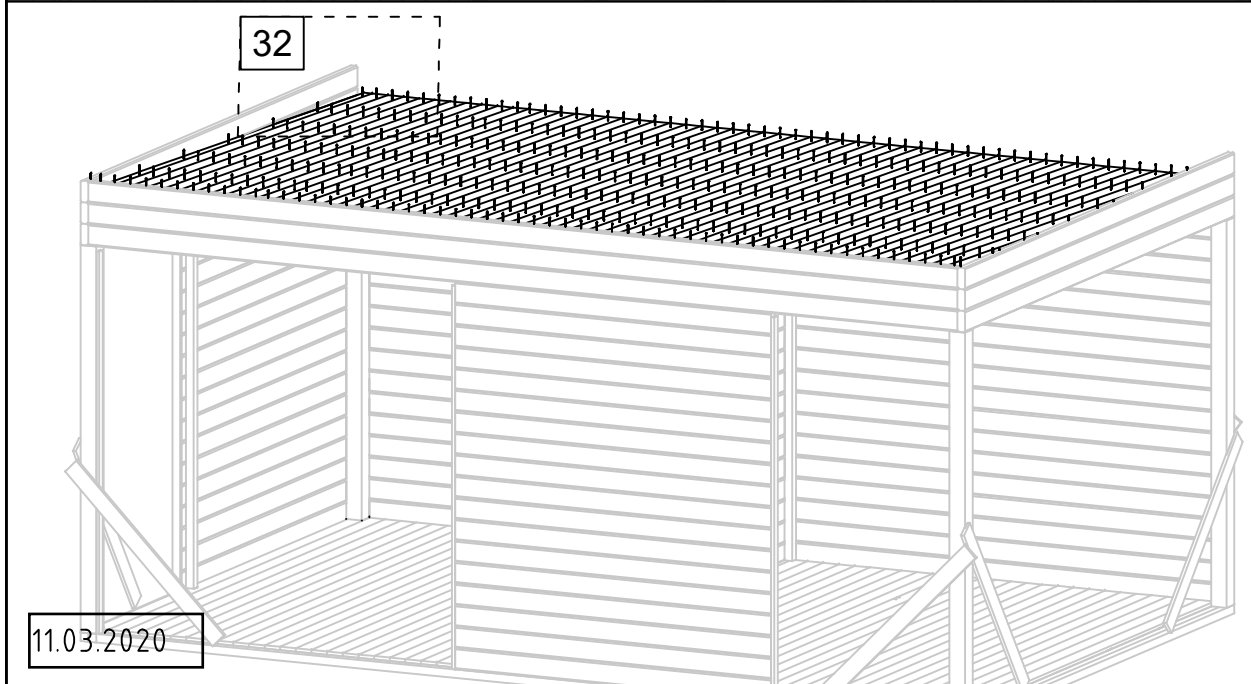
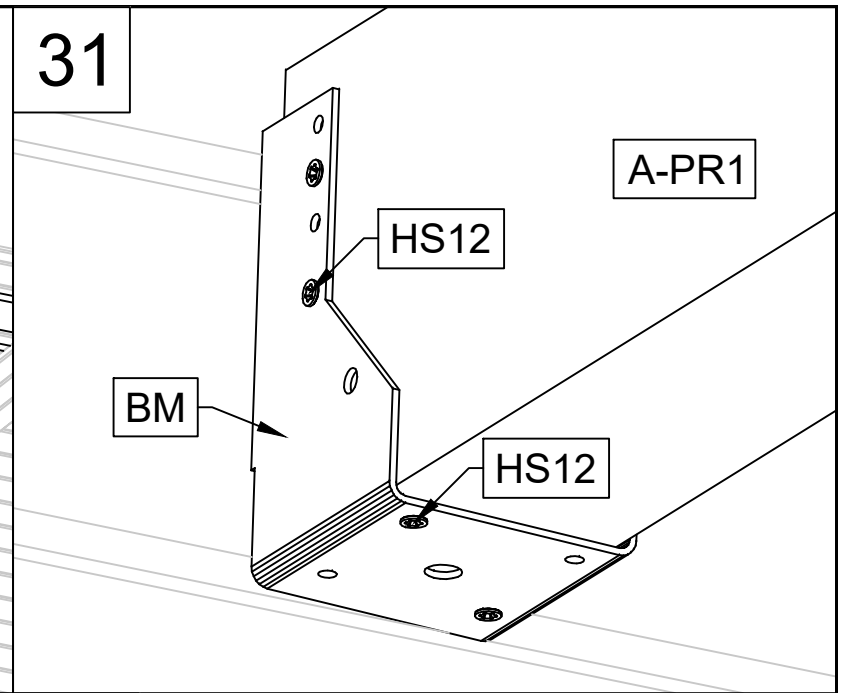
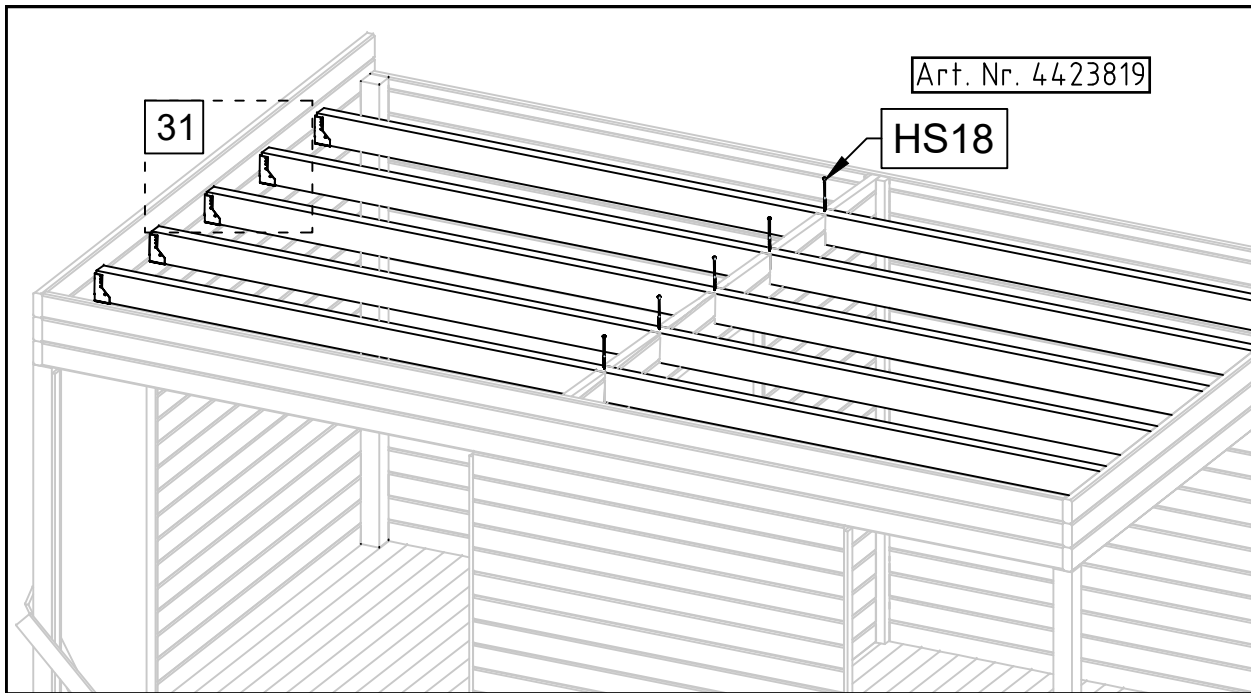

Art. Nr. 4423819

33

33

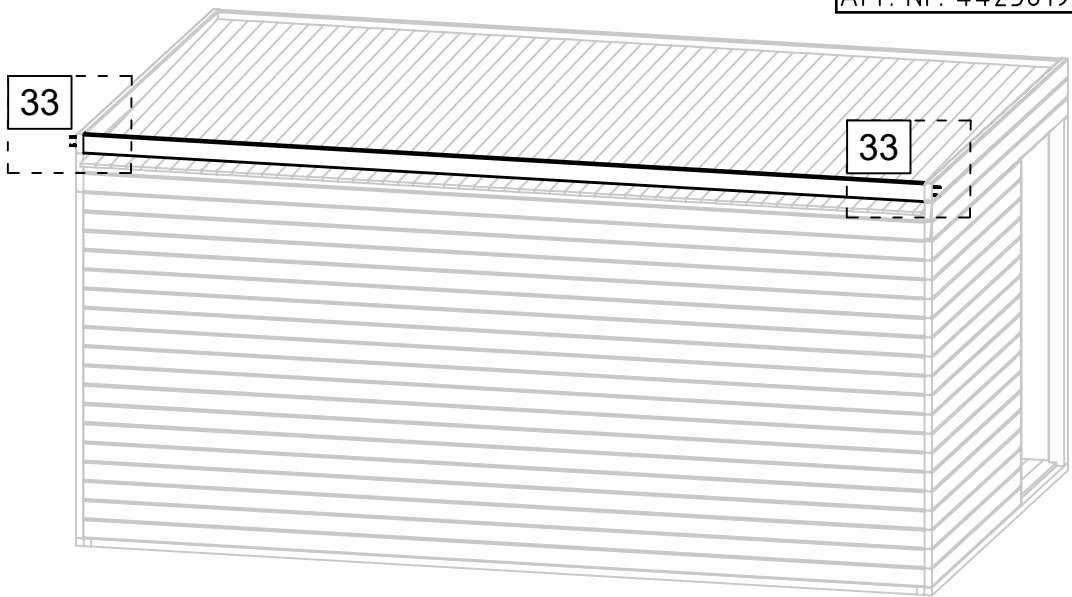

33

HS14

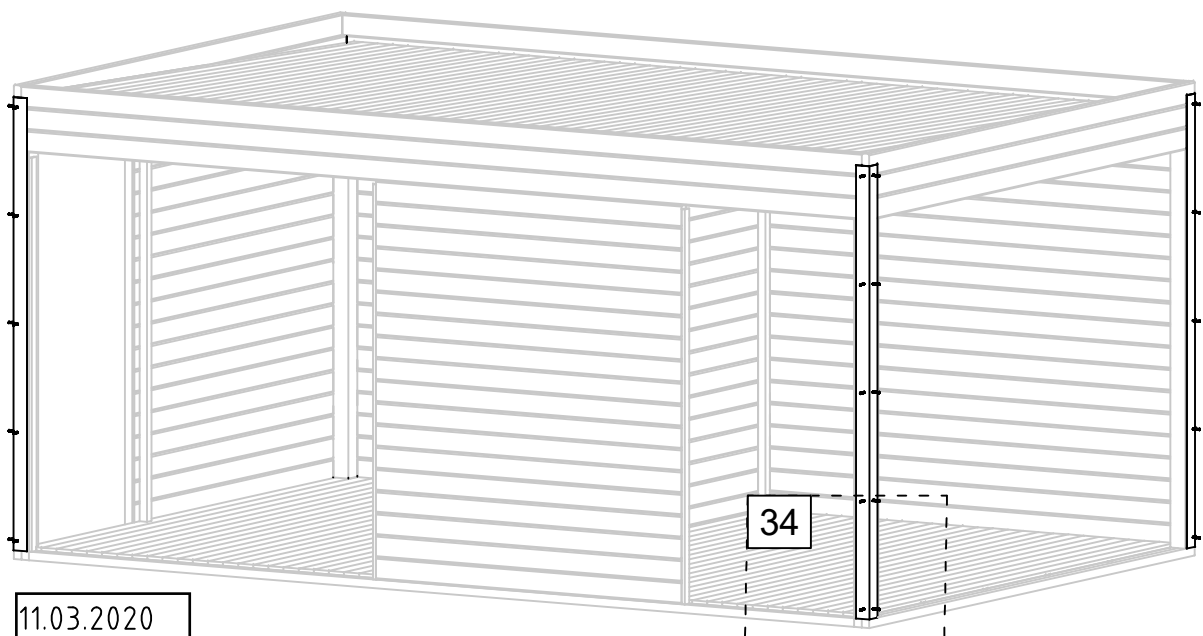
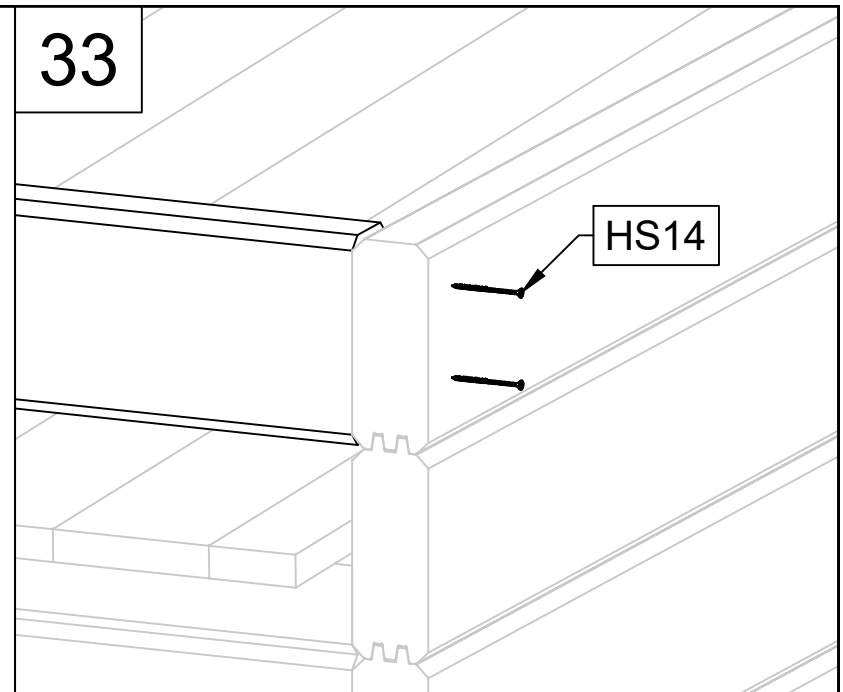

34

34

Al-1

HS29

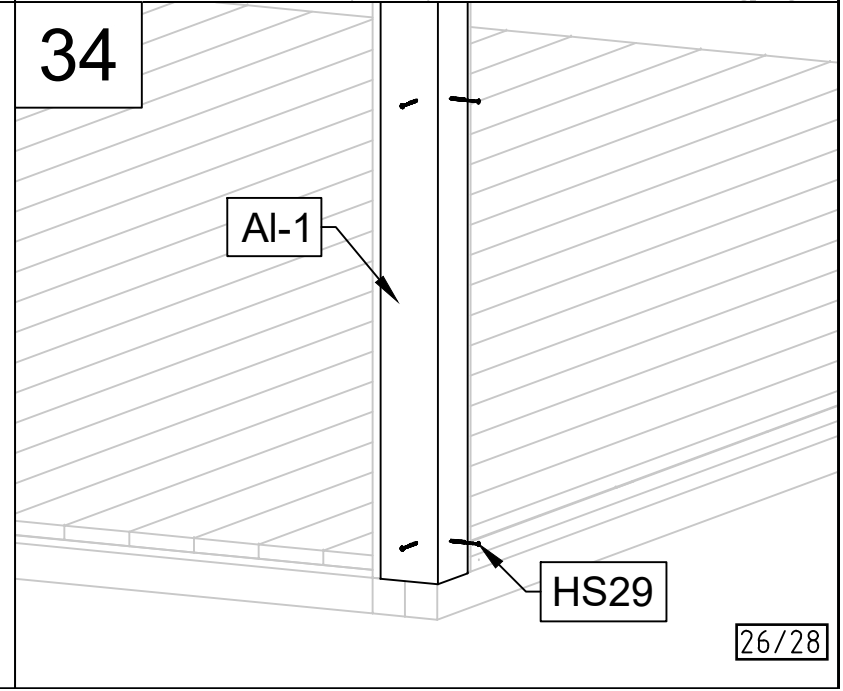

11.03.2020

26/28

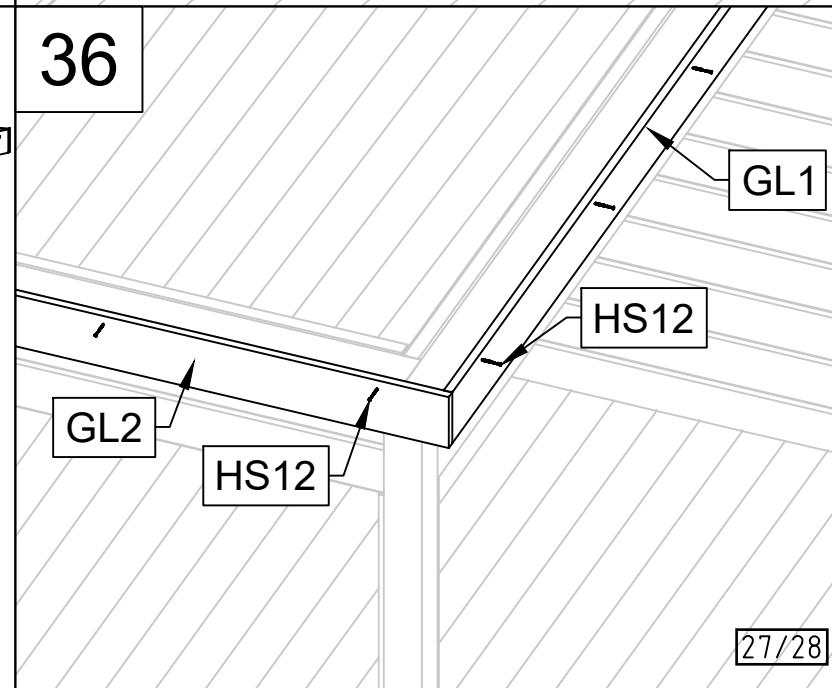
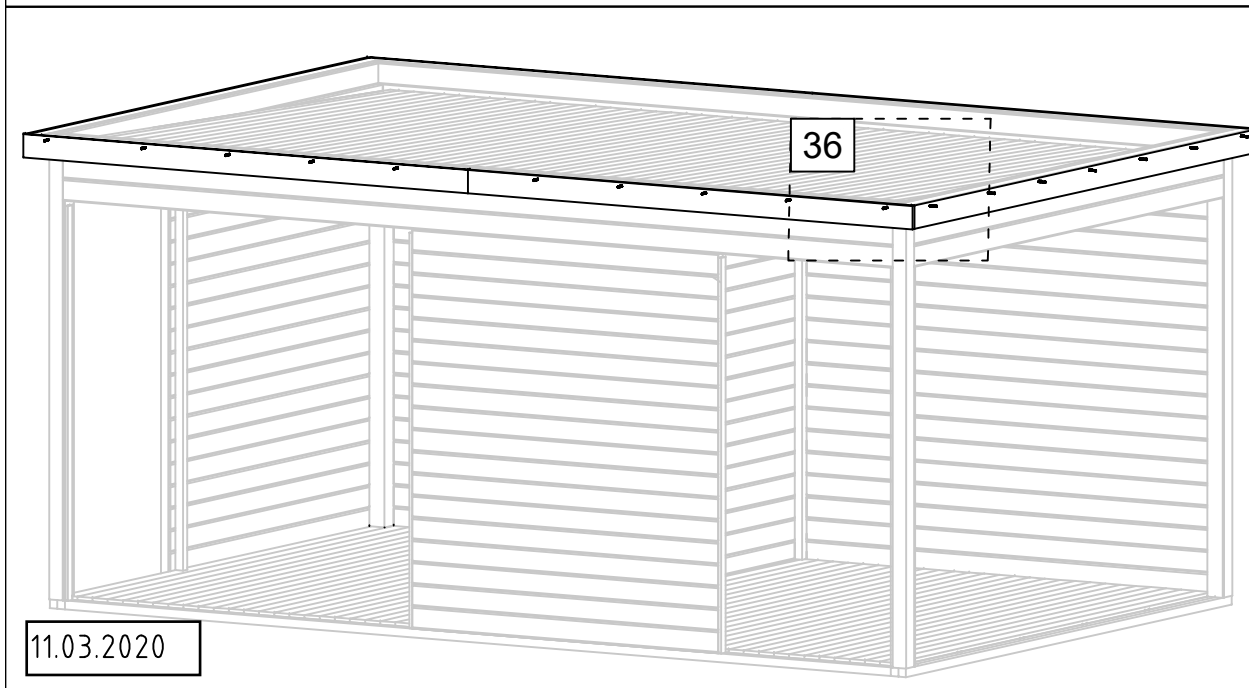
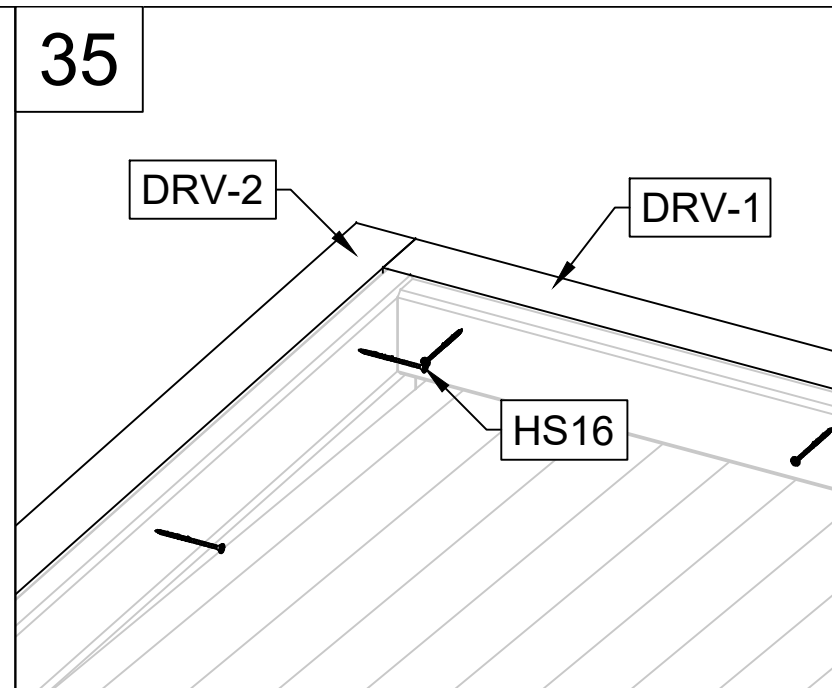
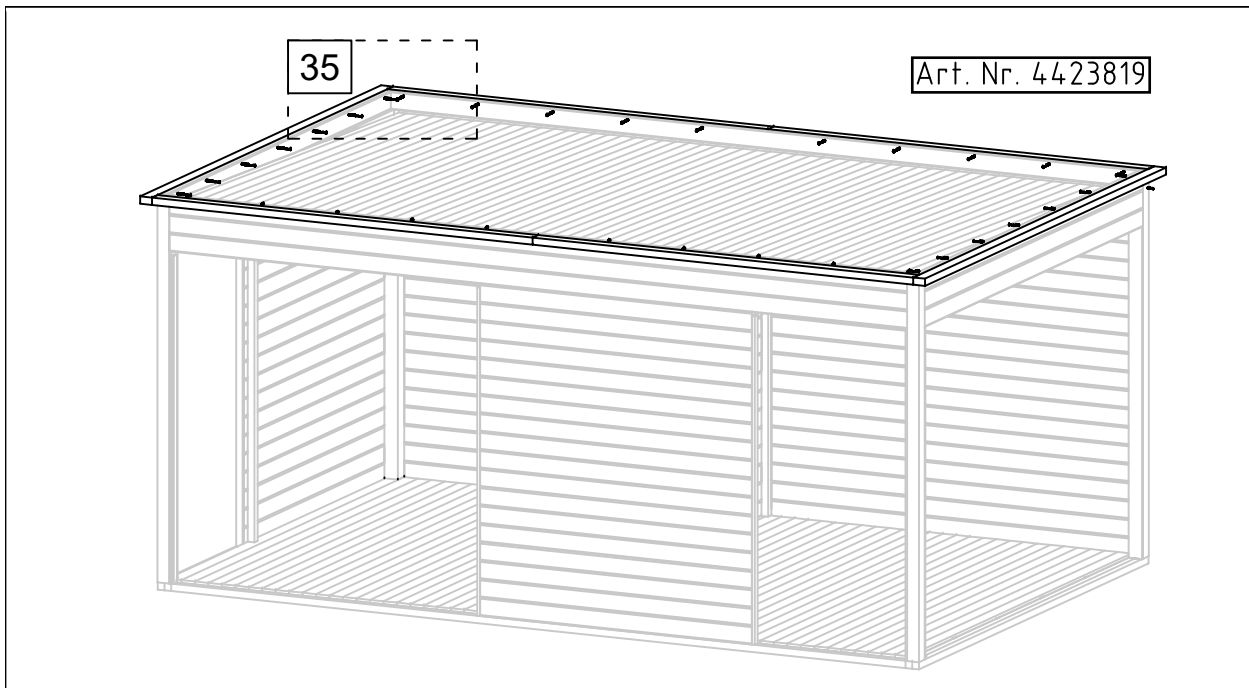

Art. Nr. 4423819

37

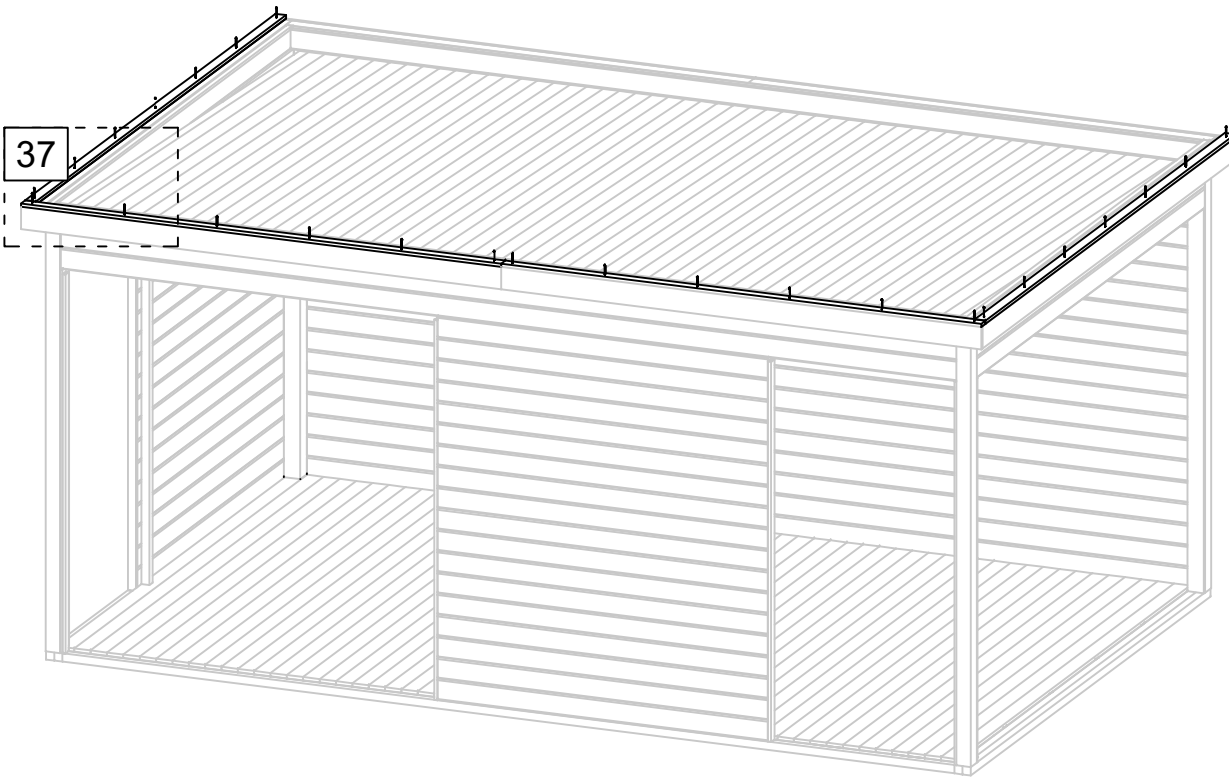

NF5





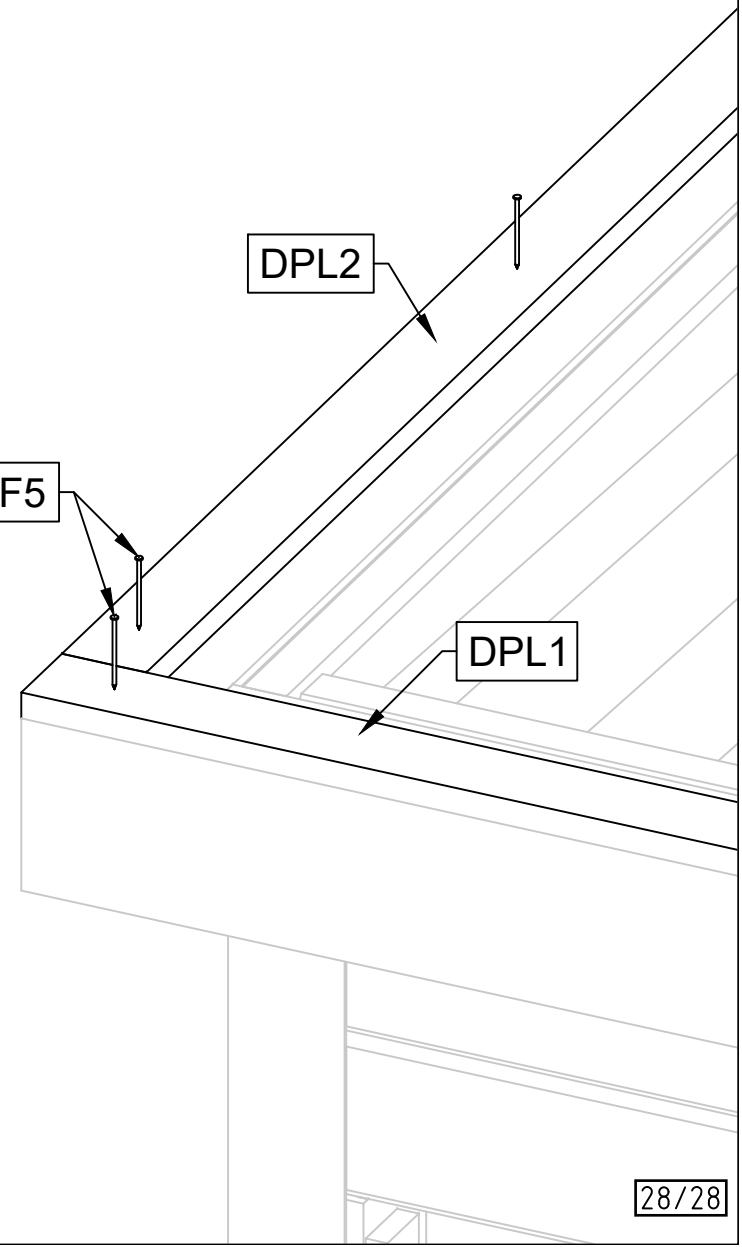

DPL2

DPL1

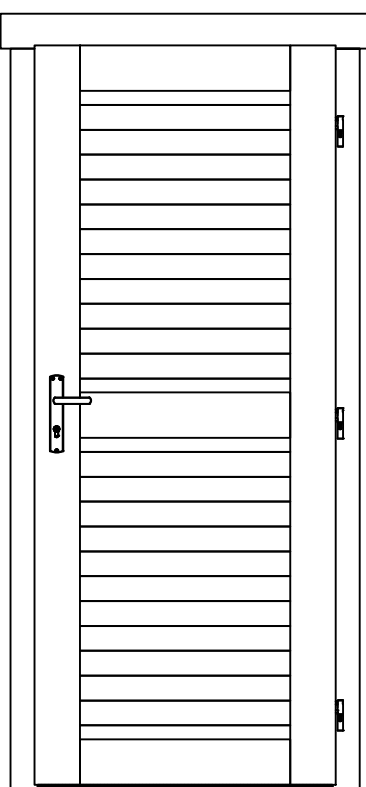
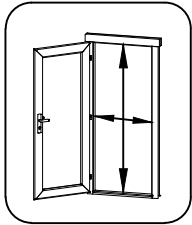

11.03.2020

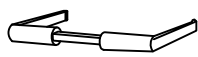
28/28

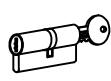
Pos	12.05.2016	Piece list - Stückliste - Liste des pièces - Elementi - Stuklijst - Tükítabel 835x1957 UL.2.100.IVP.MM TP*	1/1	Q	P (mm)	L (mm)
						735 x 1873 mm
HS16	Screw for door jamb - Schraube für Türrahmen - Vis de fixation partie haute avec montants du cadre de porte - Viti x fissaggio montanti porte - Schroef voor deurkozijn - Kruvi ukse lengile			4	5x90	
HS25	Screw for doorstep - Schrauben für swelle - Vis pour fixation barre de seuil - Vite per soglia della porta - Schroef voor deurdorpel - Kruvi tävepakute			2	4.5x65	
HC	Covers for door hinges - Schutzkappe für Türband - Couverture de paumelle de porte - Copertura delle cerniere della porta - Afdek kap voor deurscharnier - Reguleeritava potthinge kate			6		
MH	Male bolt hinge for door - Türhand - Partie male de paumelle de porte - Cerniera anube x porta - Scharnier bout - Reguleeritav potthing isane			3	14x80	
TL4	Door handle fittings - Türgriff - Poignée de porte - Maniglie - Beurhendet / klink - Ukse käepide			1		
TL5	Set of door lock covers - Schlossblenden - Set de garnitures de porte - Copertura serrature - Slot stuitplaat set - Ukse lukuplaat			1		
	Cylinder lock - Zylinderschloss - Barillet de porte - Serratura - Cylinder slot - Ukse lukusüdamik			1	30x35	



Pos	10.11.2020	Piece list - Stückliste - Liste des pièces - Elementi - Stuklijst - Tükítabel 2041x2026 ALP.2S.2R. RAL7016	1/1	Q	P (mm)	L (mm)
-----	------------	---	-----	---	-----------	-----------

Glass size - Glasgröße - Taille de la vitre - Misura del vetro - Glas afmeting - Klaasi mõõt: 926x1859 mm

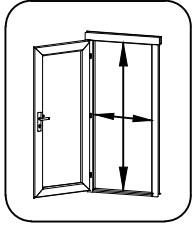

950x1930 mm

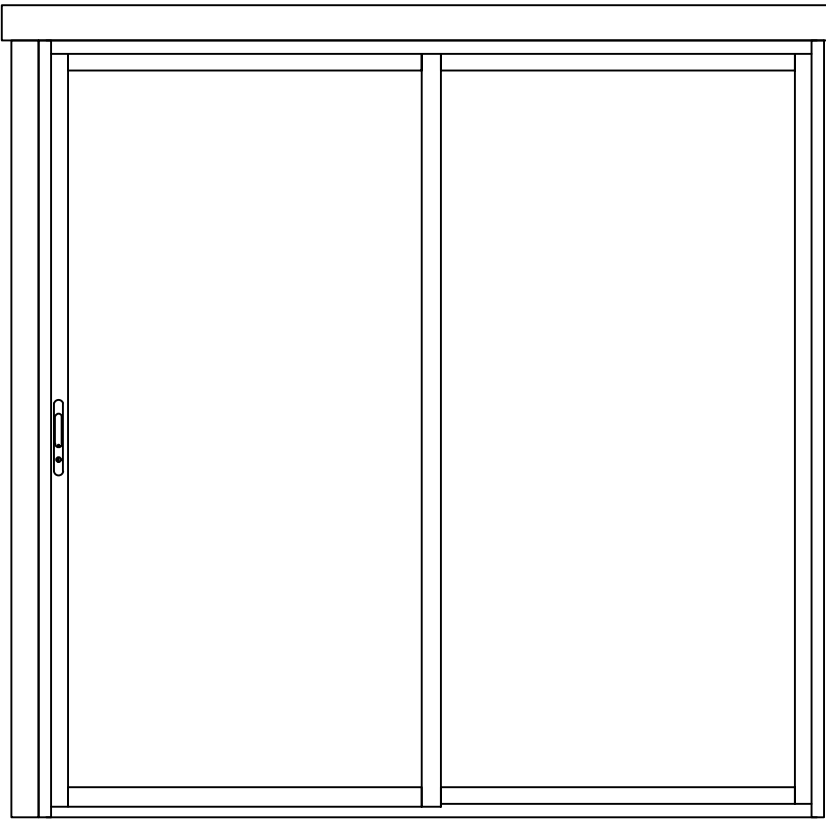

12	Upper door jamb - Türrahmen oben - Cadre de porte supérieur - Telaio superiore della porta - Bovendorpet - Ükse ütemine teng		1	35x60	1982
9	Doorstep - Swelle - Seuil de porte - Callare - Drempel - Lävepakk ukseavale		1	35x60	1982
10-11	Door jamb - Türrahmen - Cadre de porte - Telaio montante della porta - Deurframe - Ükse teng		2	32x63	2000

Pos

10.11.2020

Piece list - Stückliste - Liste des pièces - Elementi - Stuklijst - Tükítabel

1003x2026 ALP.F. RAL 7016

1/1

Q

P

(mm)



L

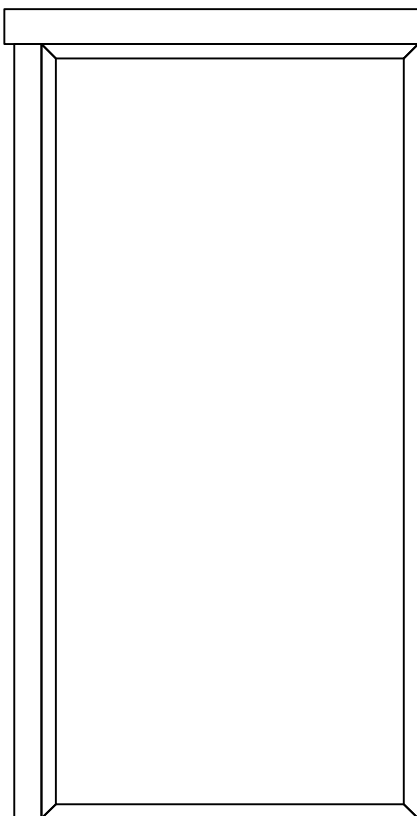

(mm)

Glass size - Glasgröße - Taille de la vitre - Misura del vetro - Glas afmeting - Klaasi mõõt: 916x1939 mm



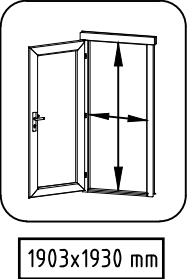
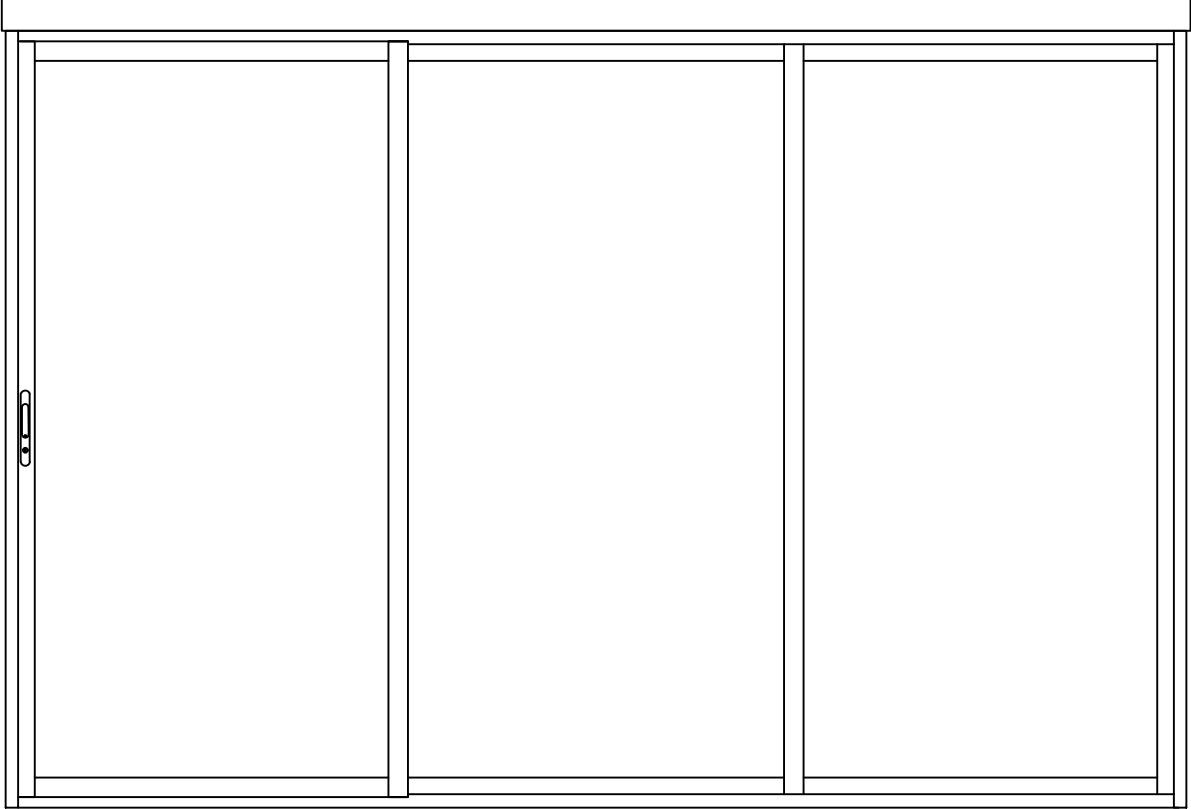

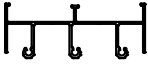
Pos	25.06.2020	Piece list - Stückliste - Liste des pièces - Elementi - Stuklijst - Tükítabel 3039x2026 ALP.2S.2R. RAL7016	1/1	Q	 (mm)	 (mm)
Glass size - Glasgröße - Taille de la vitre - Misura del vetro - Glas afmeting - Klaasi mõõt: 926x1859 mm Glass size - Glasgröße - Taille de la vitre - Misura del vetro - Glas afmeting - Klaasi mõõt: 984x1859 mm						
						

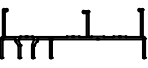
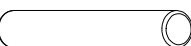
18	Upper door jamb - Türrahmen oben - Cadre de porte supérieur - Telaio superiore della porta - Bovendorpel - Ukse ütemine teng		2	35x90	1500
15	Doorstep - Swelle - Seuil de porte - Callare - Drempel - Lävepakk ukseavale		2	35x90	1500
16-17	Door jamb - Türrahmen - Cadre de porte - Telaio montante della porta - Deurframe - Ukse teng		2	32x93	2000
	Pin - Pin - Épingle - Perno - Pin - Tihvt		6		

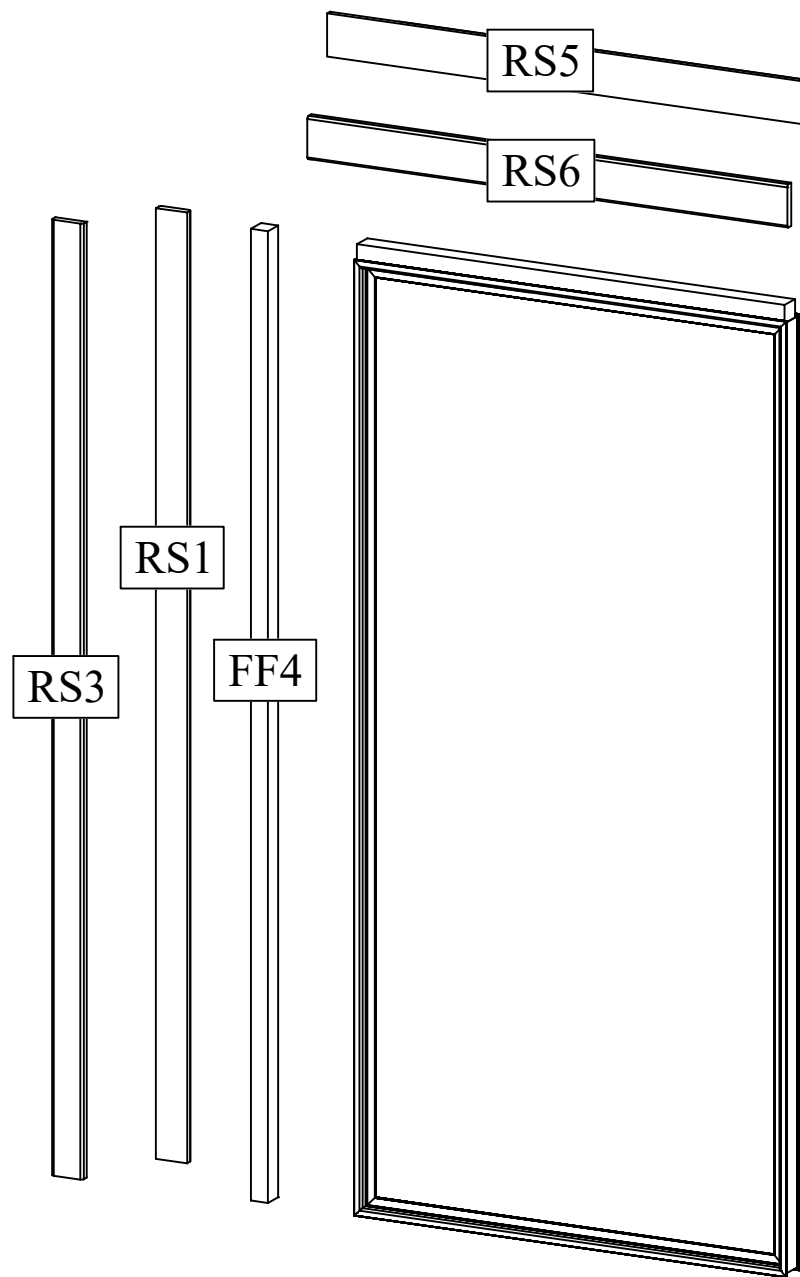

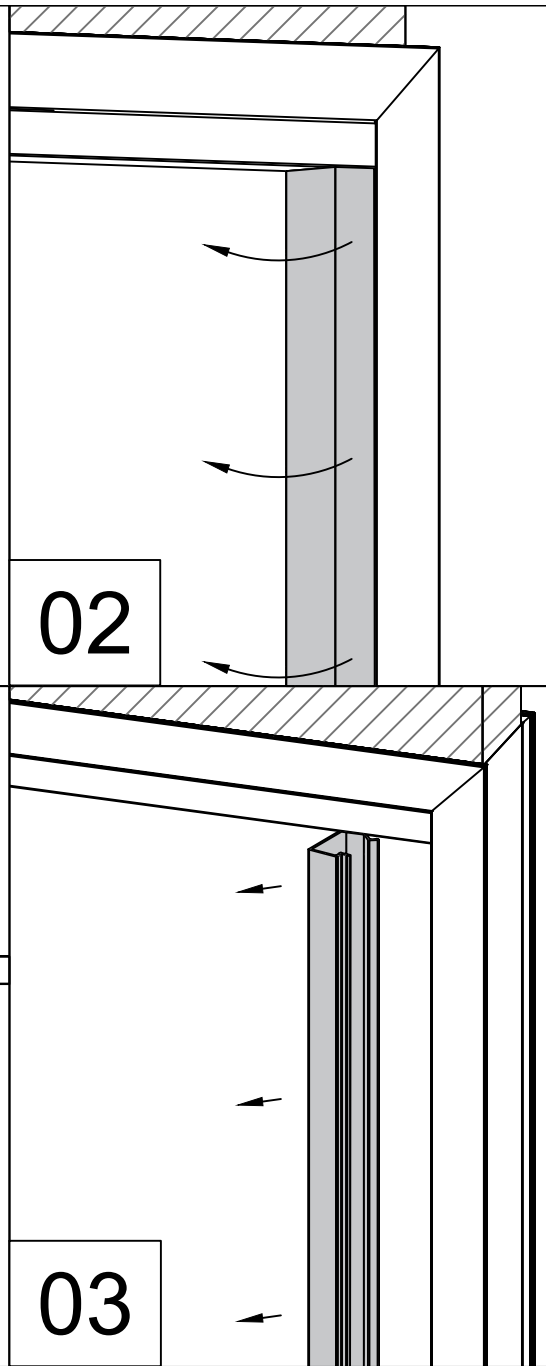
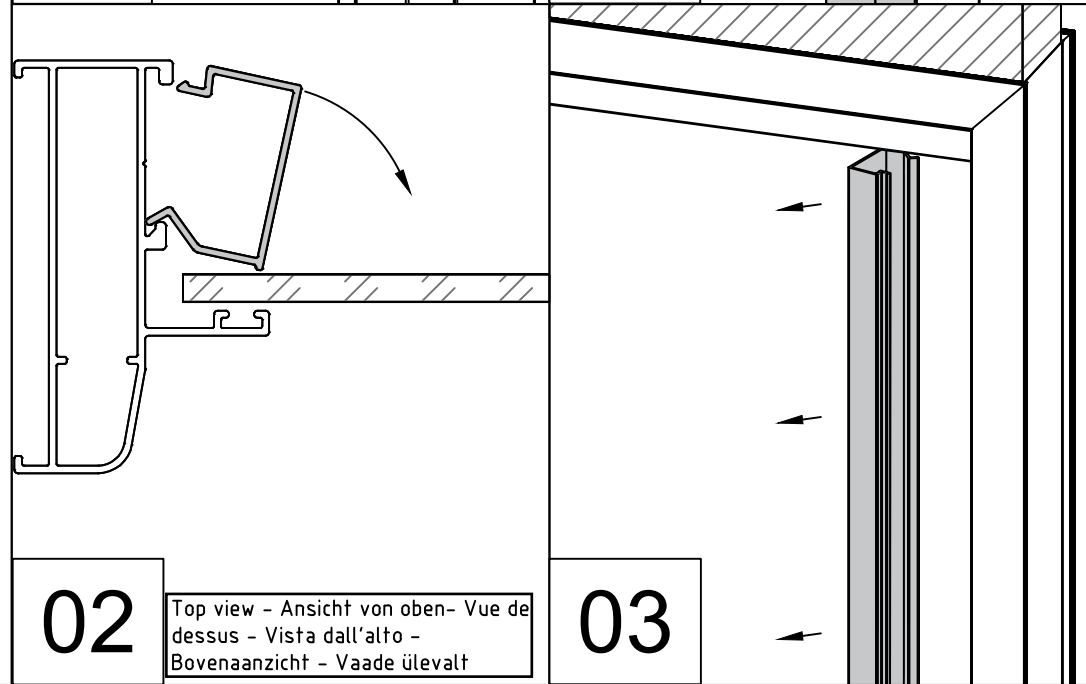
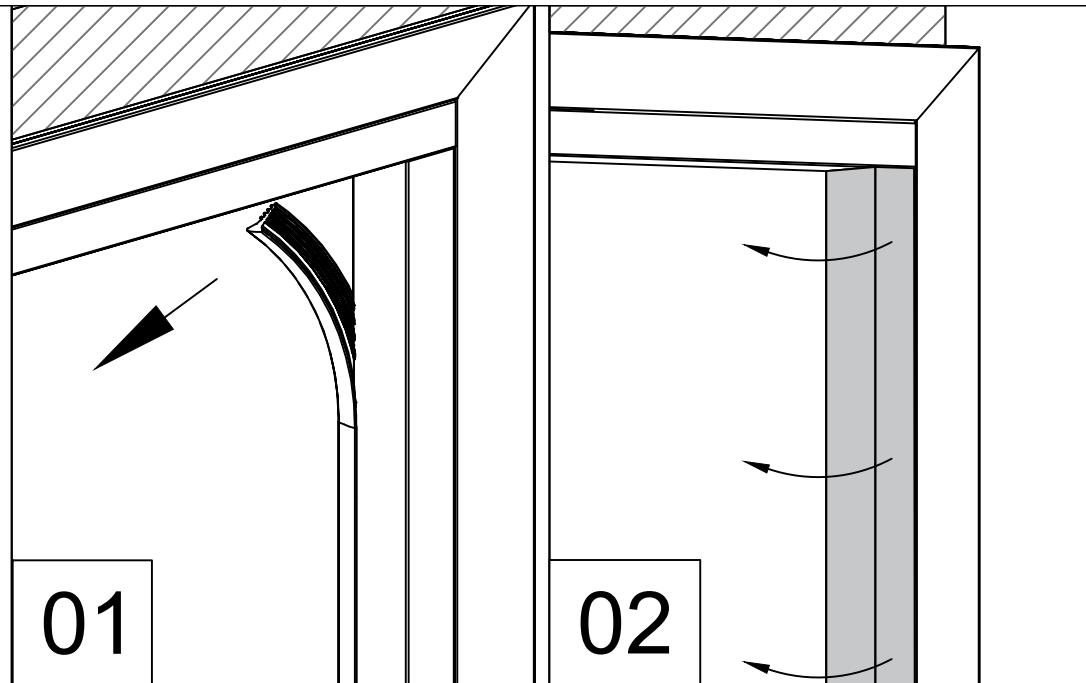
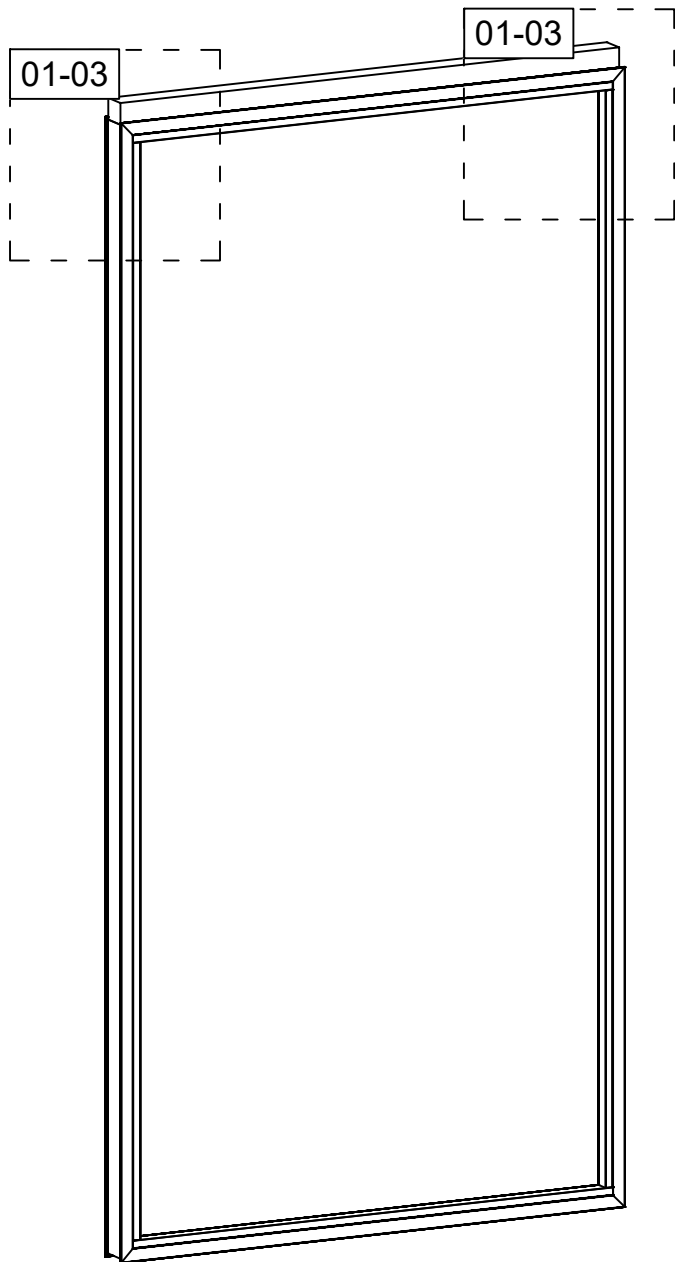

Inside view - Ansicht von innen - Vue intérieur - Vista interna - Binnenaanzicht - Vaade seest

General installation instructions - Allgemeine aufbauanleitung - Consignes générales de montage - Istruzioni per l'assemblaggio - Algemene opbouwhandleiding - Üldine püstitusjuhend

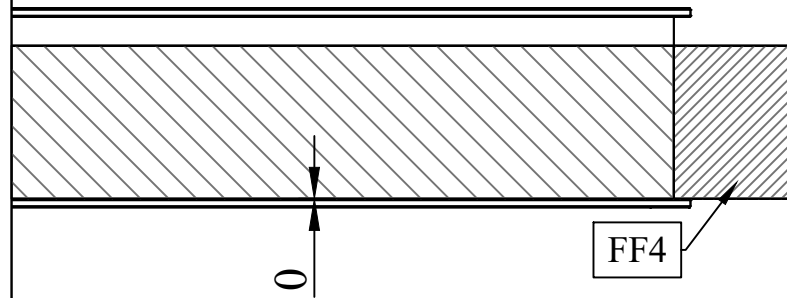
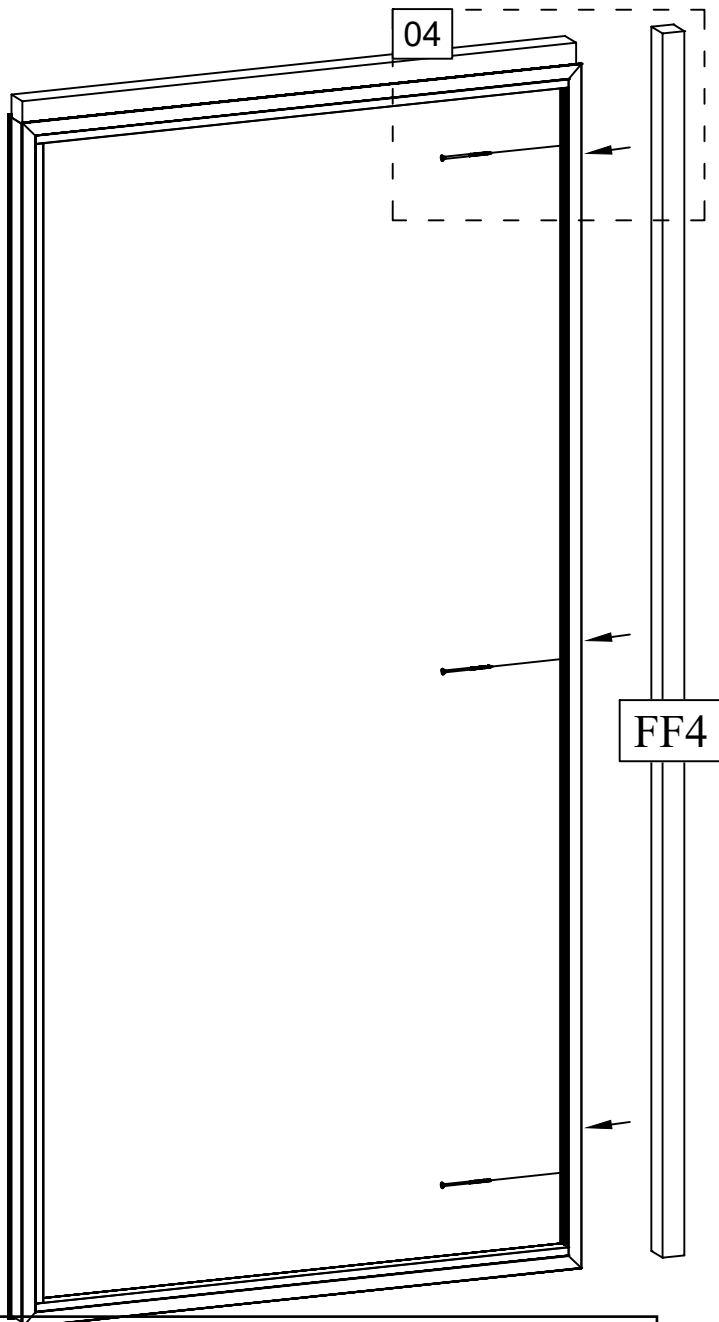

04

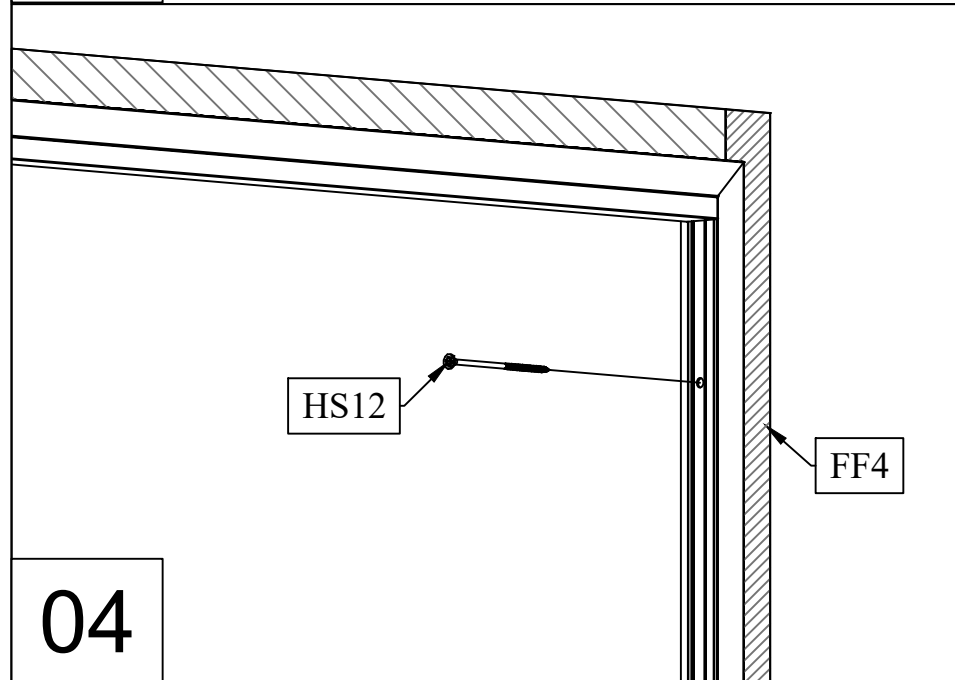

04

Inside view - Ansicht von innen - Vue intérieur - Vista interna - Binnenaansicht - Vaade seest

General installation instructions - Allgemeine aufbauanleitung - Consignes générales de montage - Istruzioni per l'assemblaggio - Algemene opbouwhandleiding - Üldine püstitusjuhend

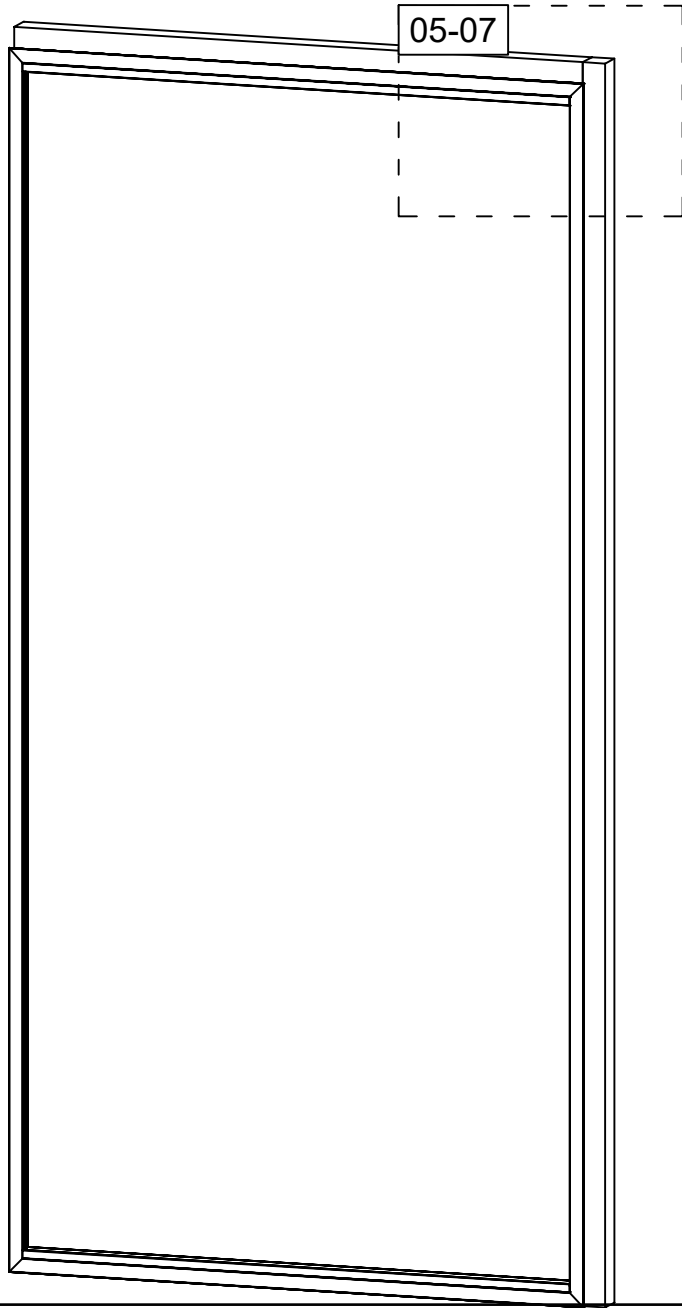

Inside view - Ansicht von innen - Vue intérieur - Vista interna - Binnenaansicht - Vaade seest

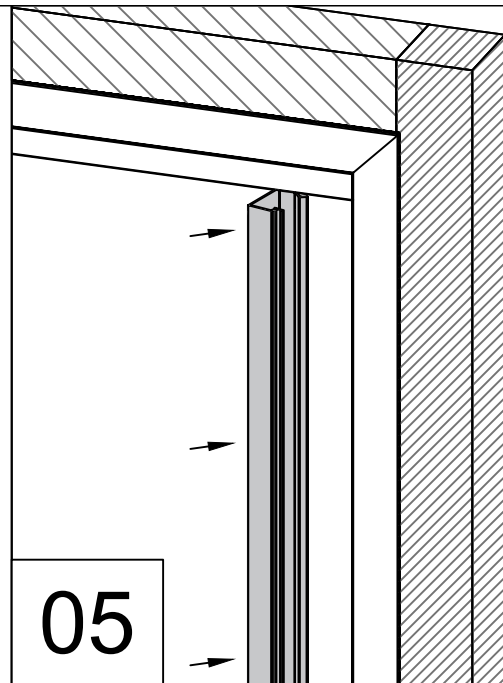

05

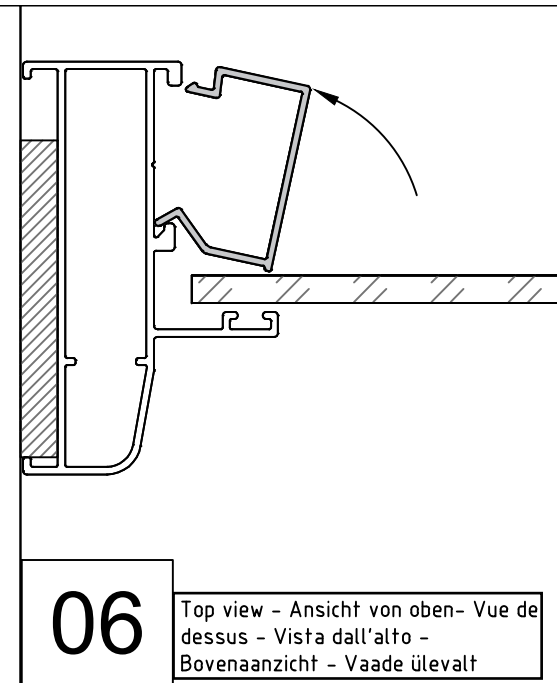

06

Top view - Ansicht von oben - Vue de dessus - Vista dall'alto - Bovenaanzicht - Vaade ülevalt

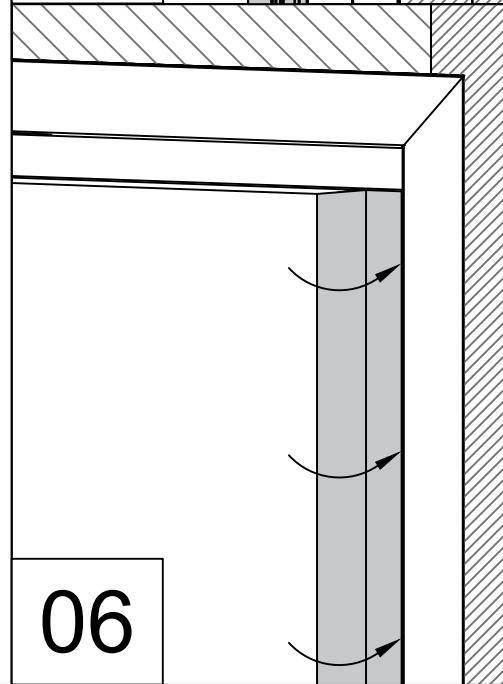

06

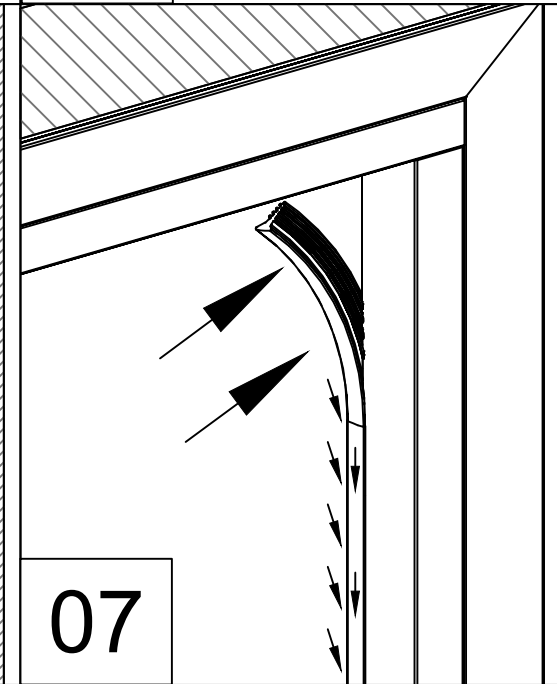

07

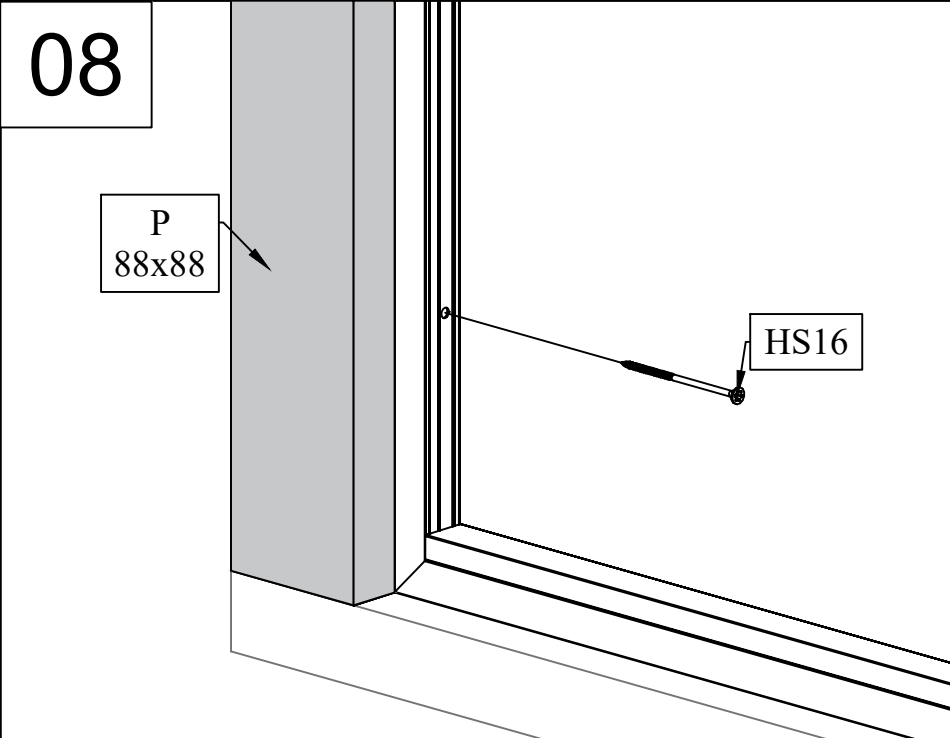
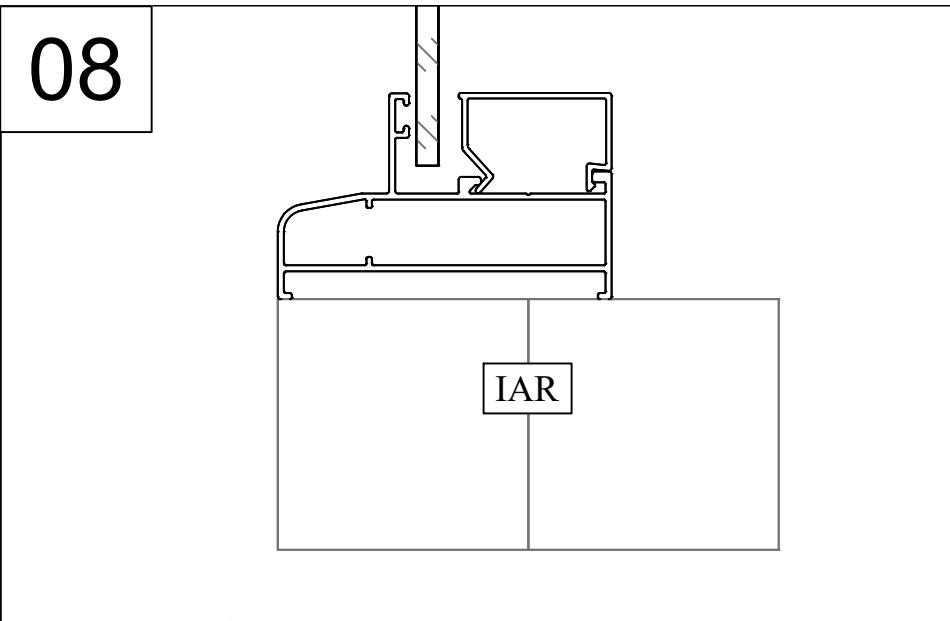
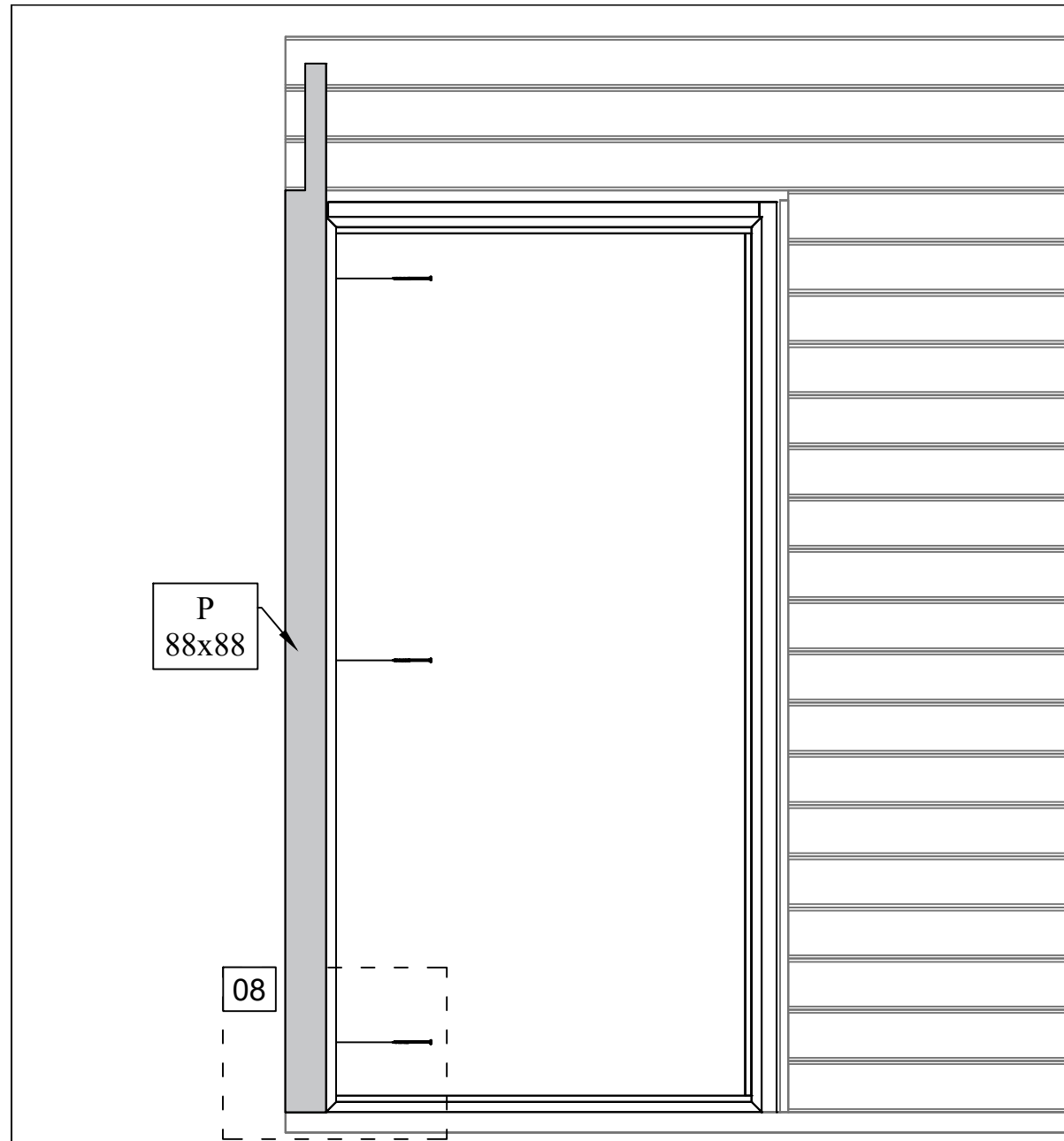

Inside view - Ansicht von innen - Vue intérieur - Vista interna - Binnenaansicht - Vaade seest

General installation instructions - Allgemeine aufbauanleitung - Consignes générales de montage - Istruzioni per l'assemblaggio - Algemene opbouwhandleiding - Üldine püstitusjuhend

09-11

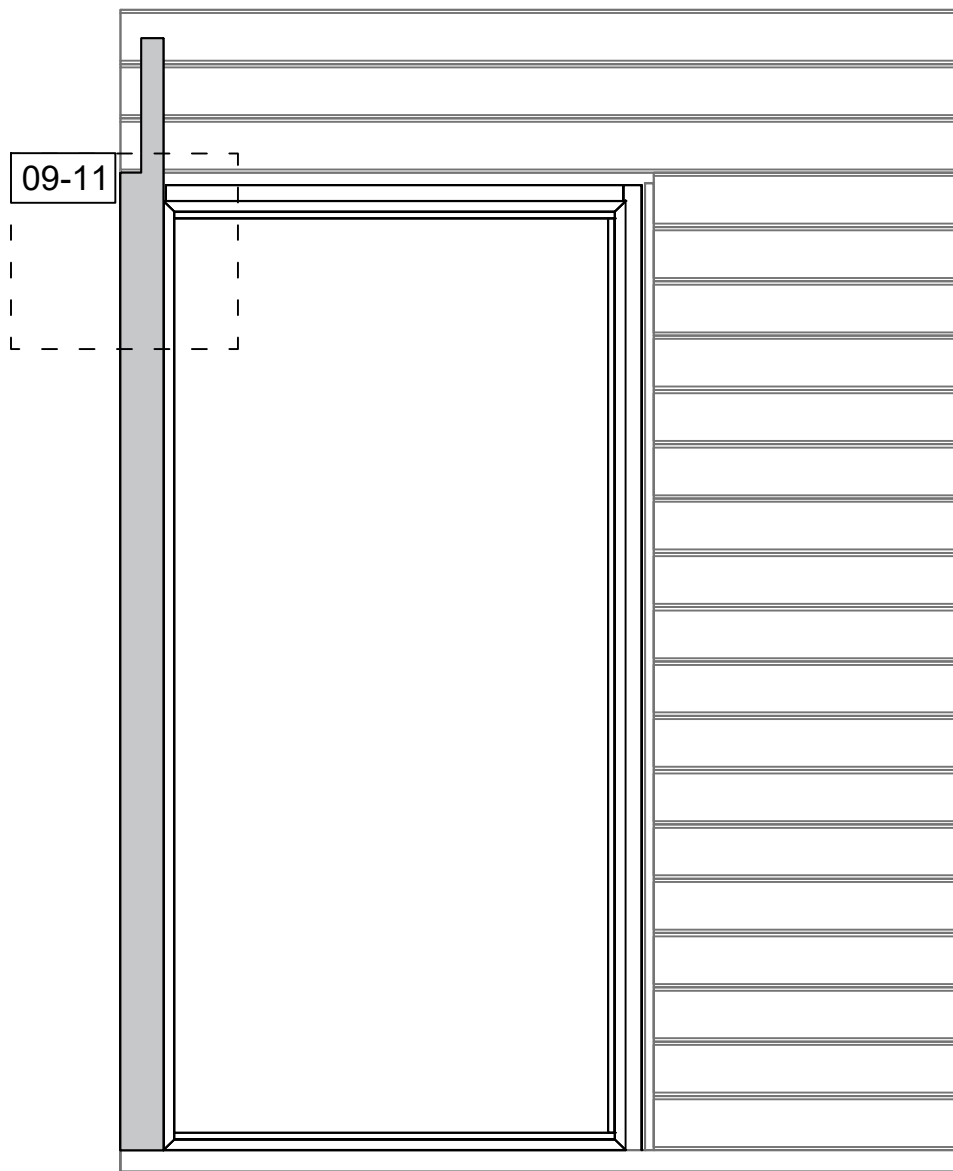

09

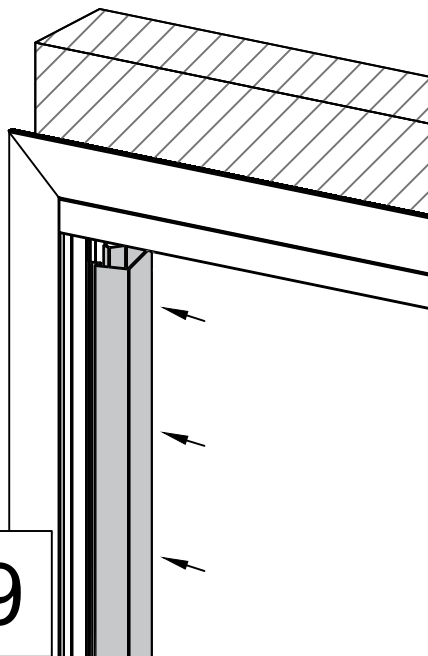

10

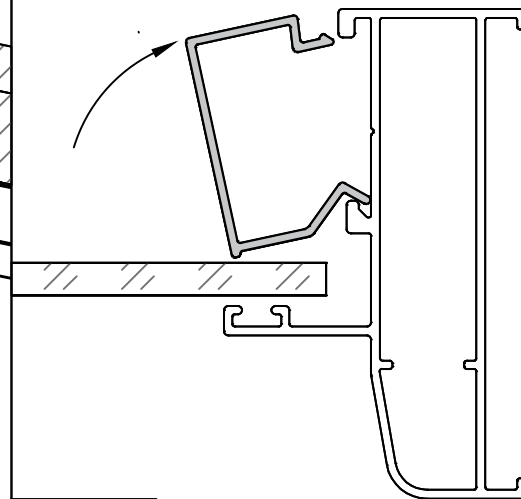

Top view - Ansicht von oben - Vue de dessus - Vista dall'alto - Bovenaanzicht - Vaade ülevalt

10

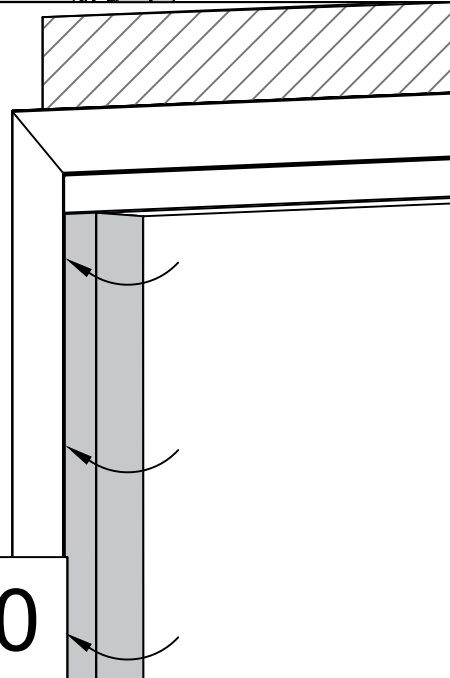

11

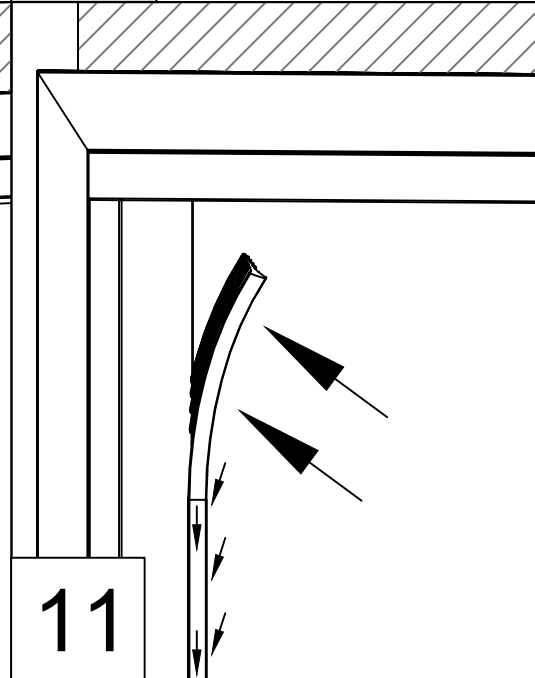

Inside view - Ansicht von innen - Vue intérieur - Vista interna - Binnenaanzicht - Vaade seest

General installation instructions - Allgemeine aufbauanleitung - Consignes générales de montage - Istruzioni per l'assemblaggio - Algemene opbouwhandleiding - Üldine püstitusjuhend

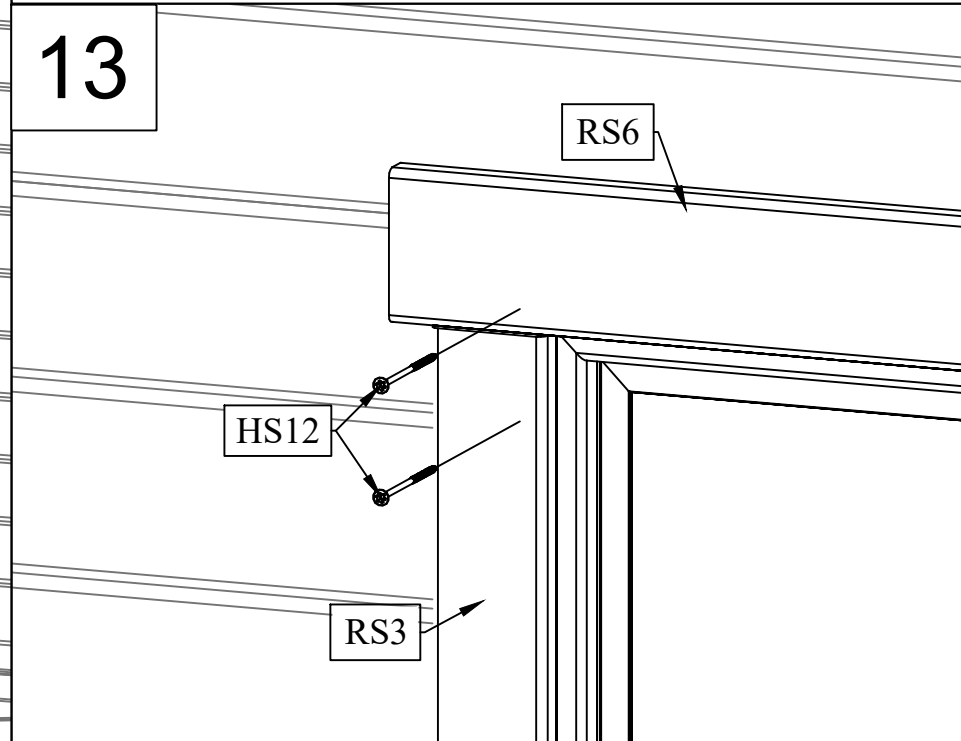
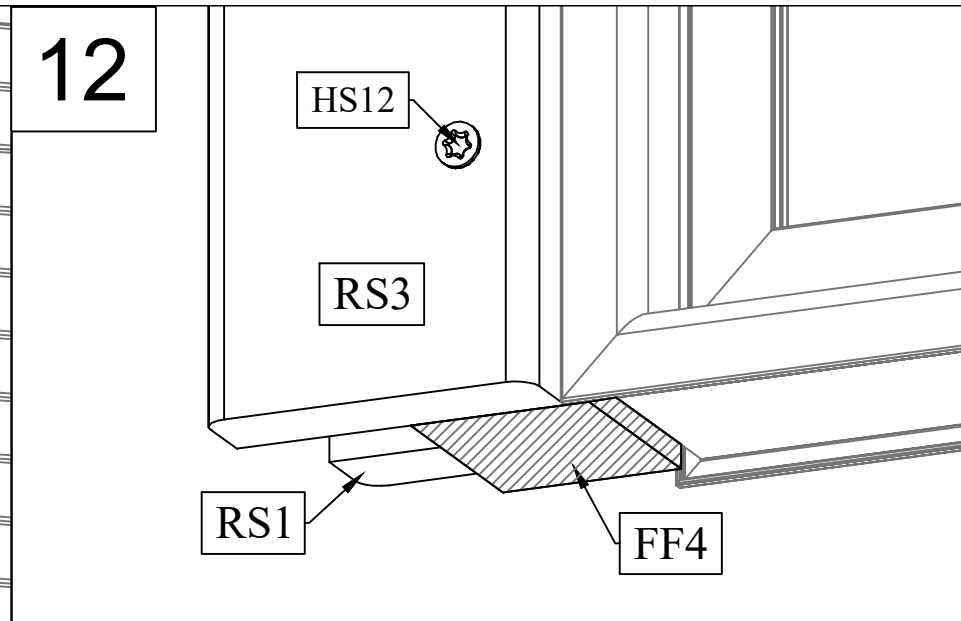
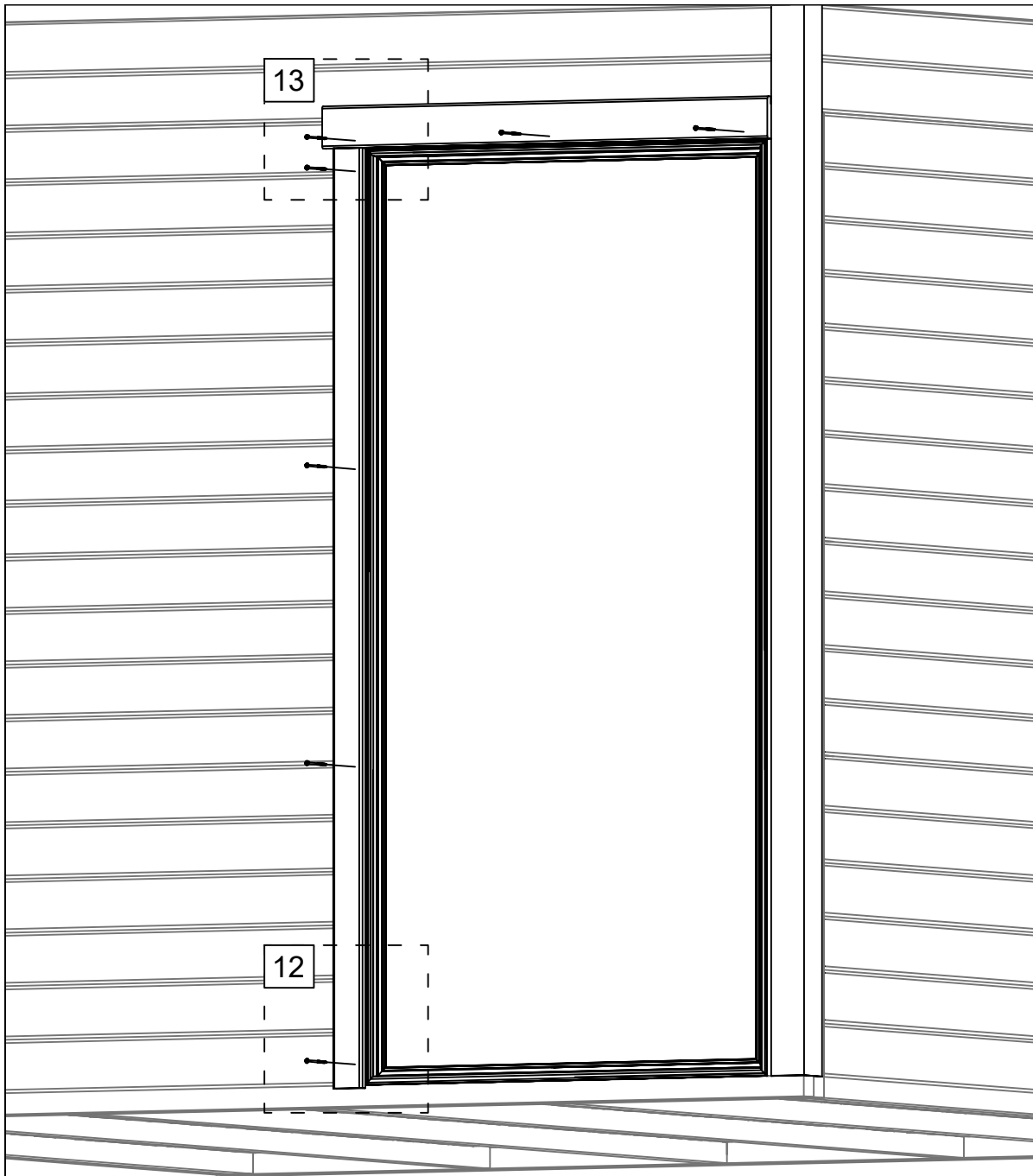



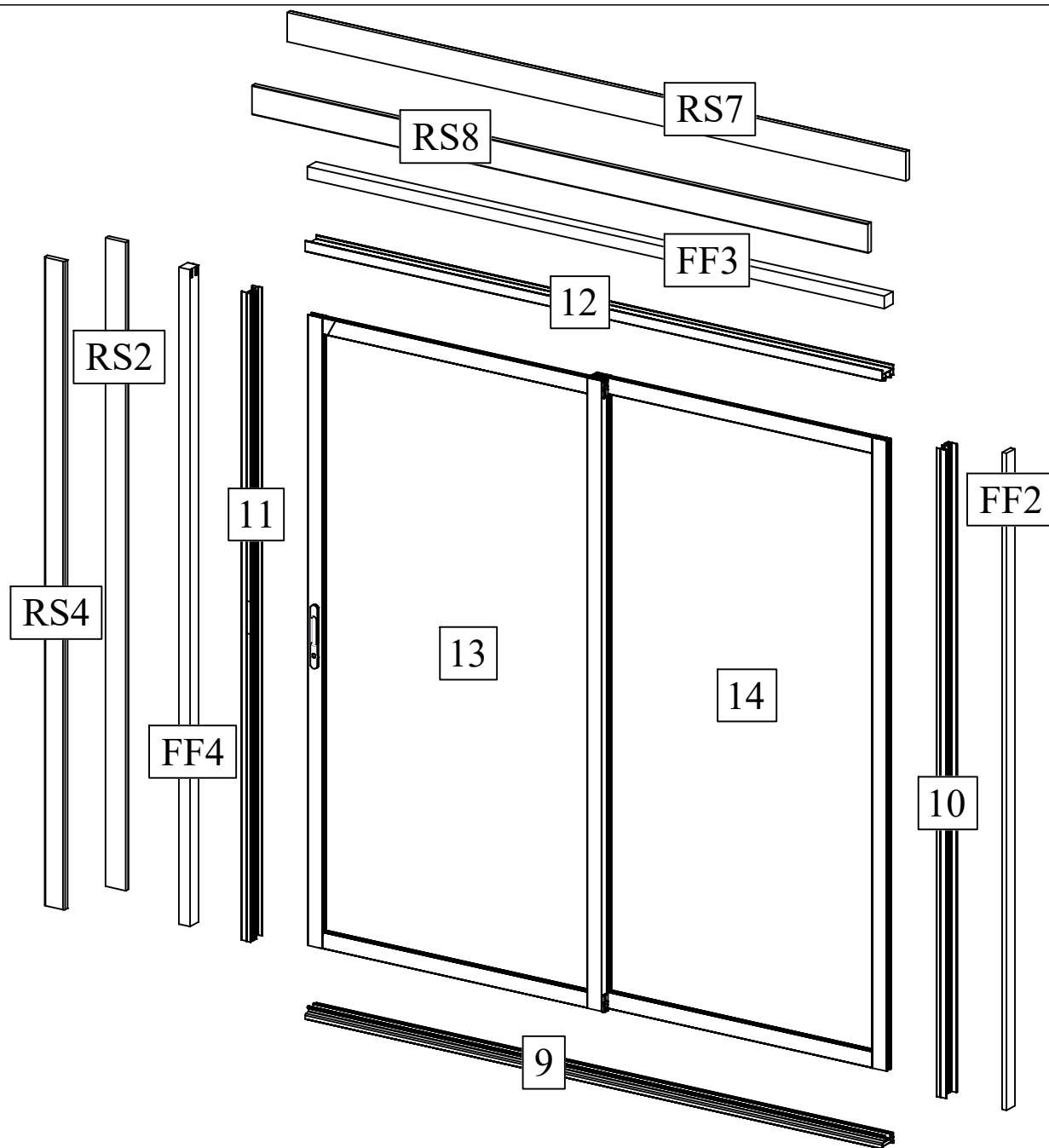

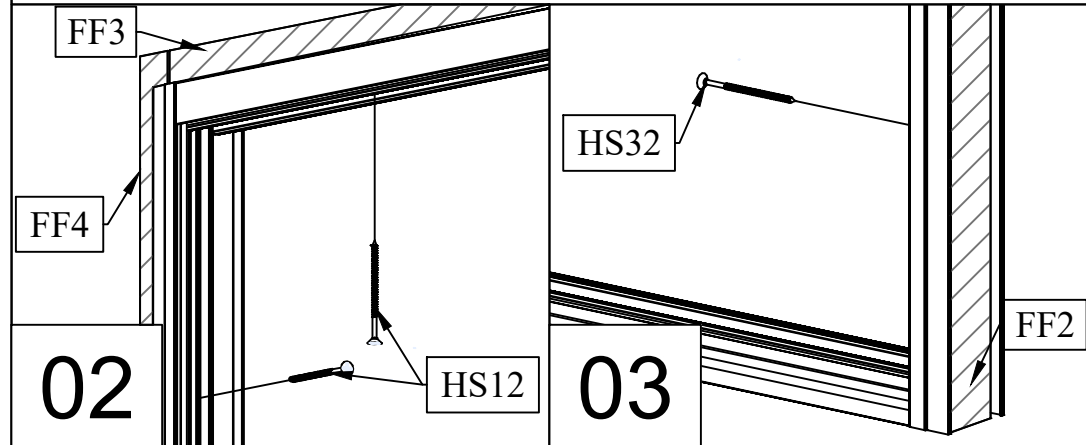
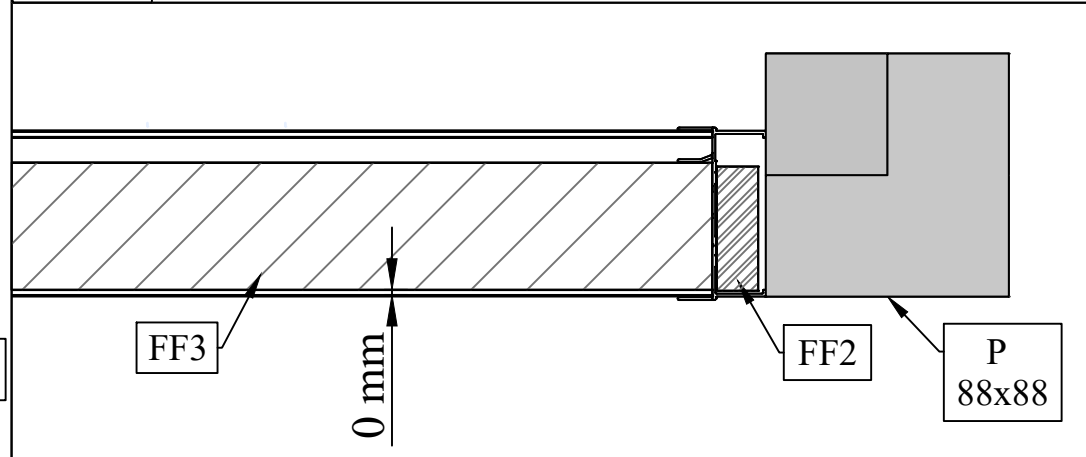
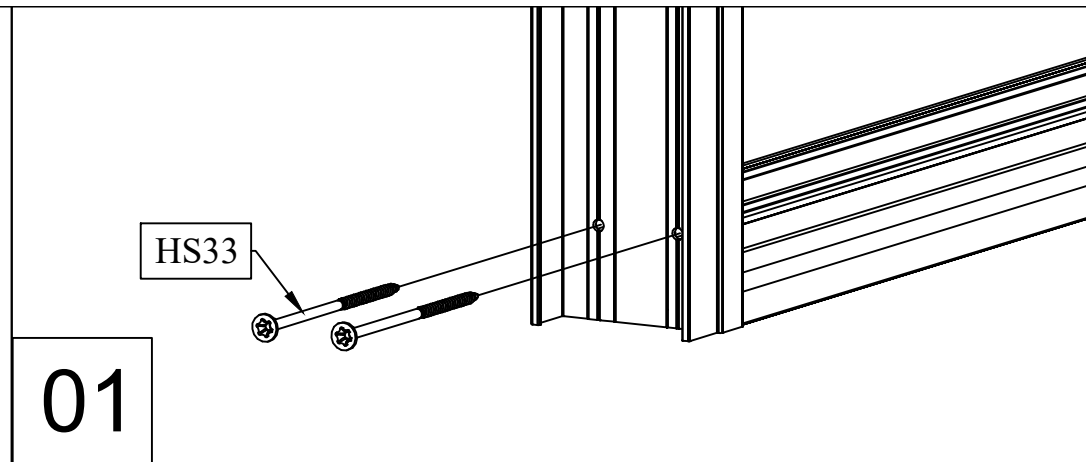
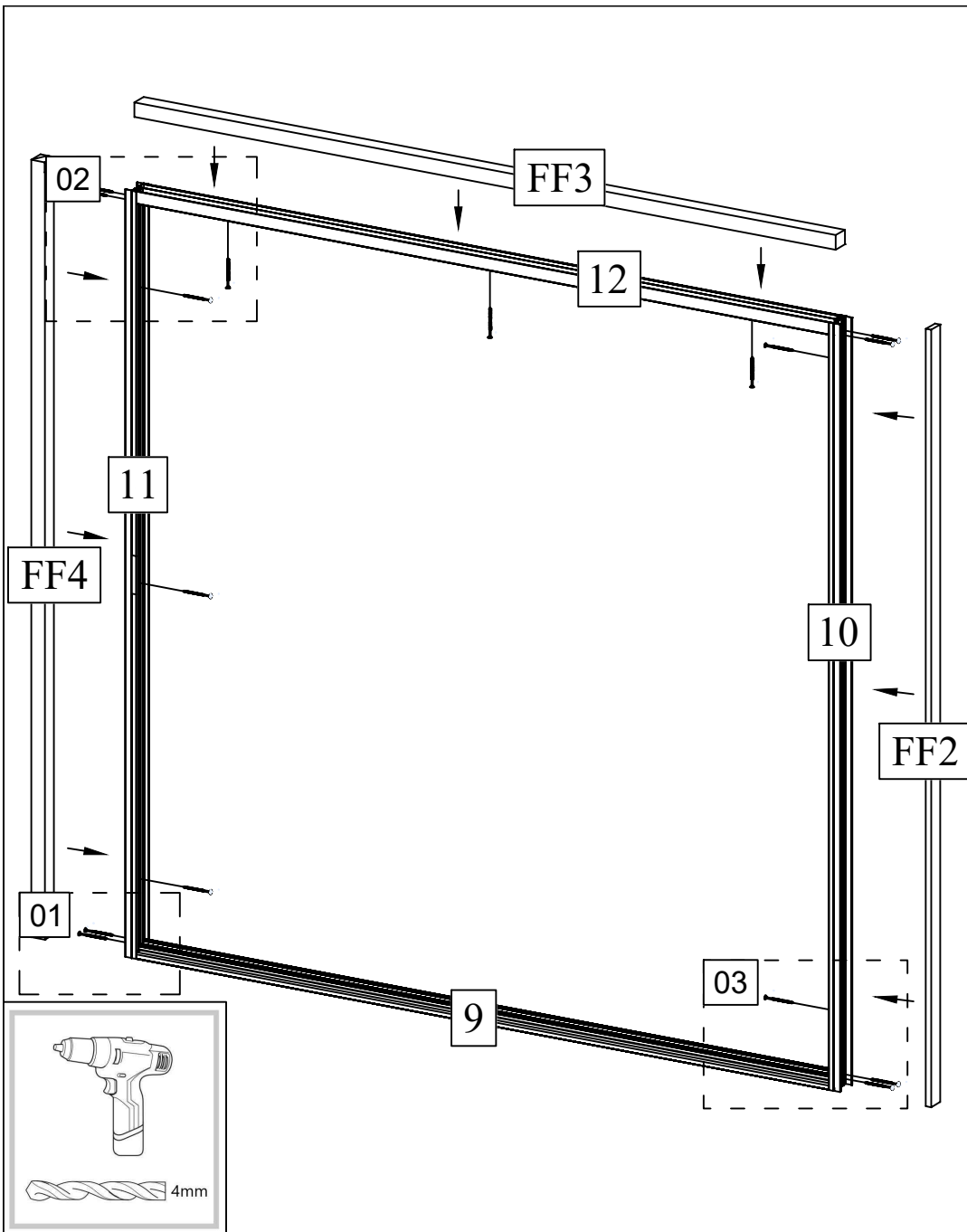

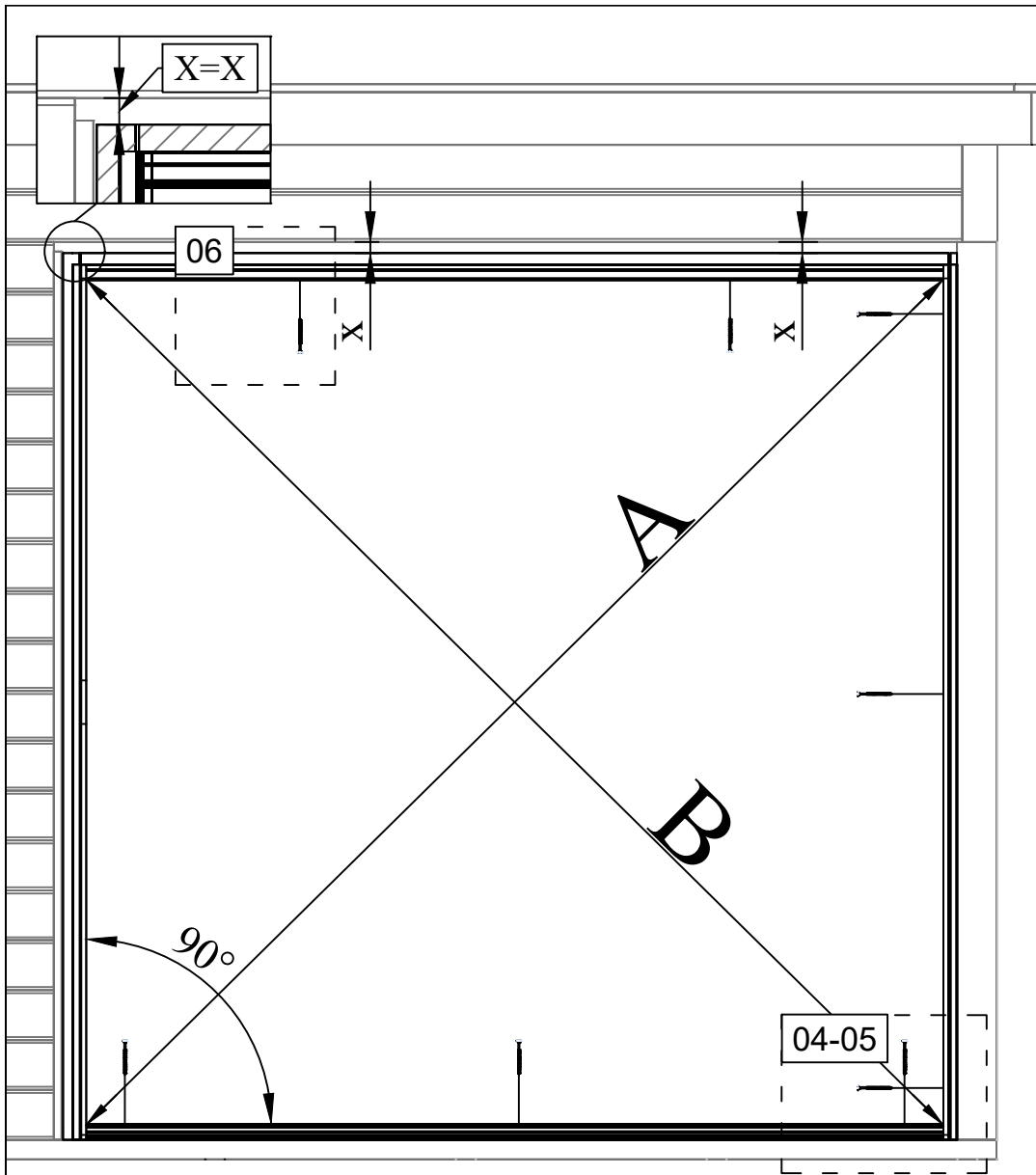

**A=B**

**04**

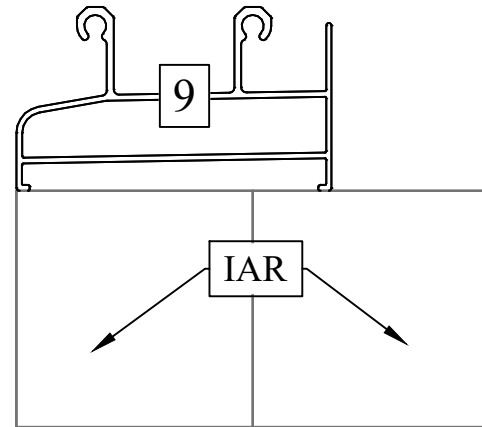

**05**

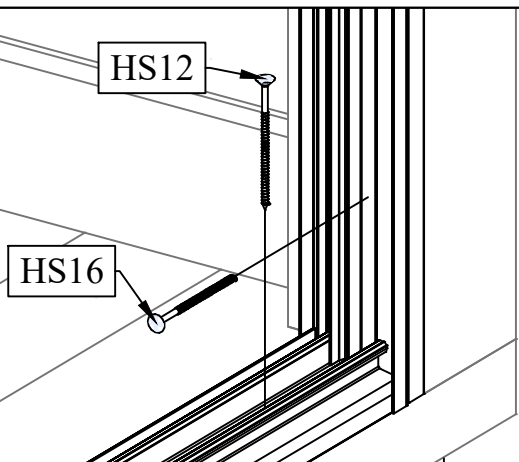

**06**

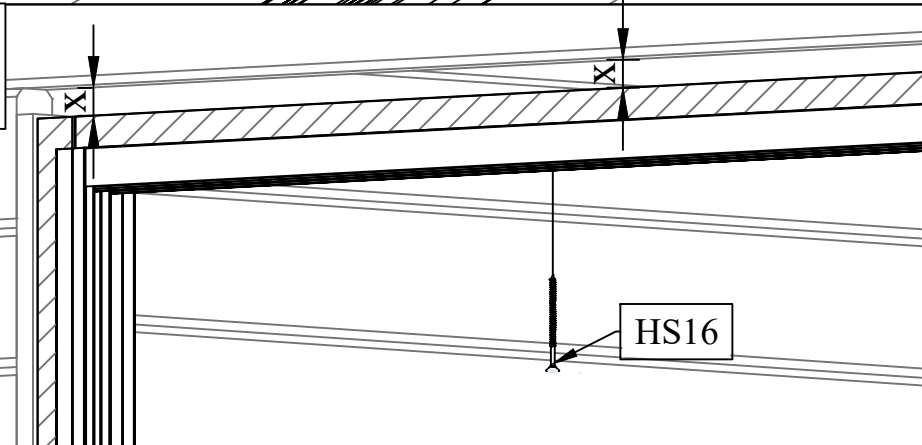

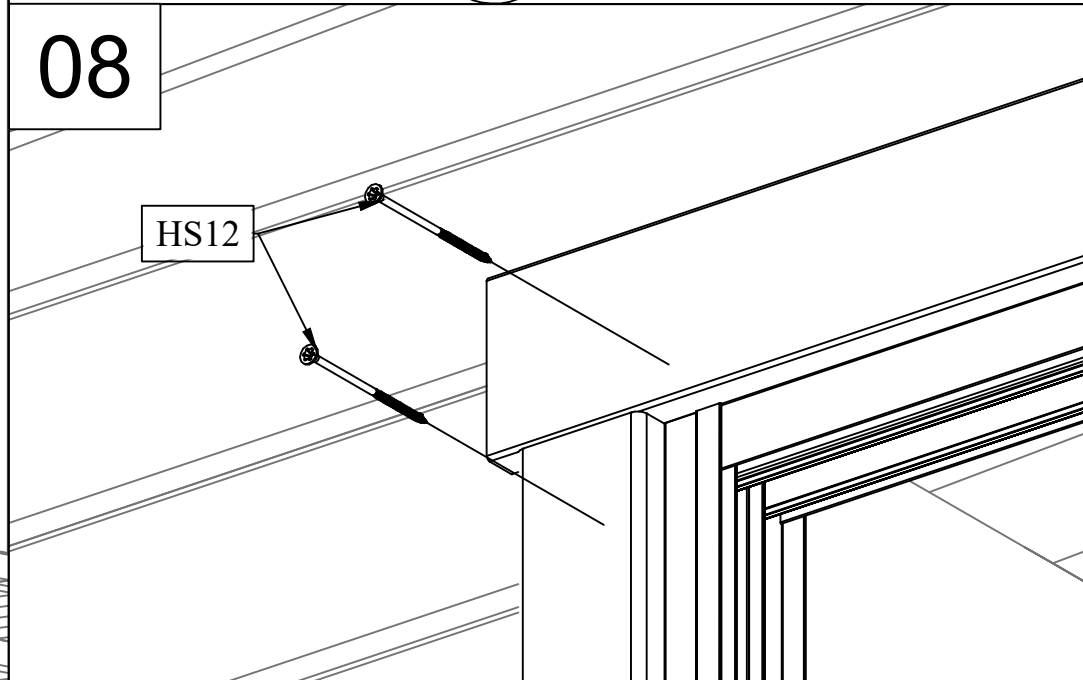
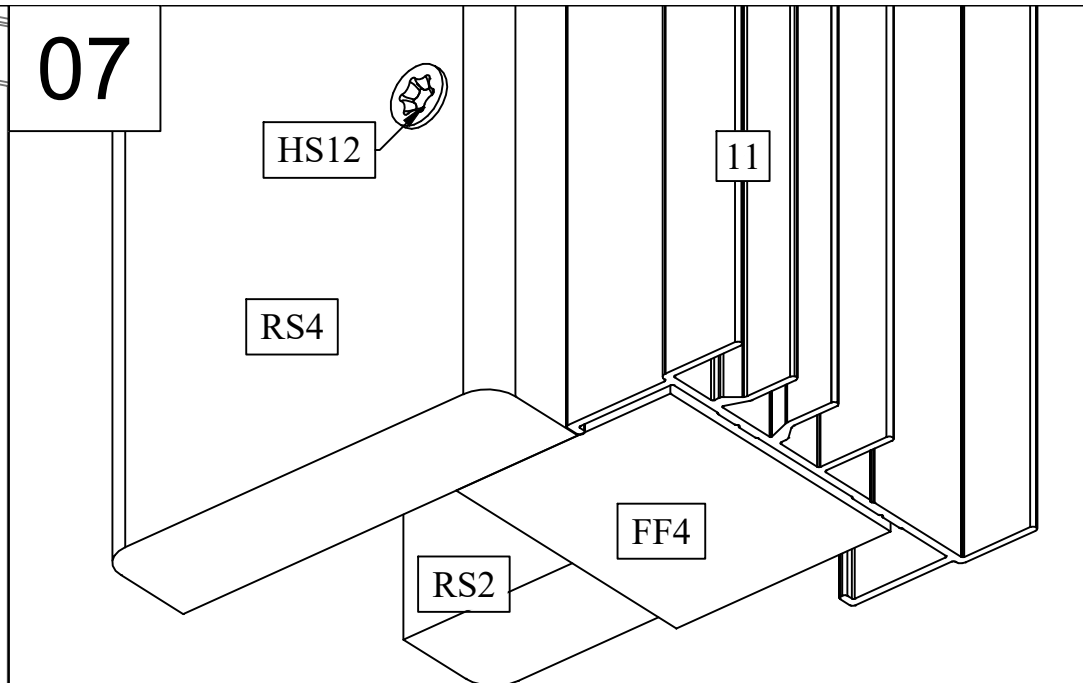
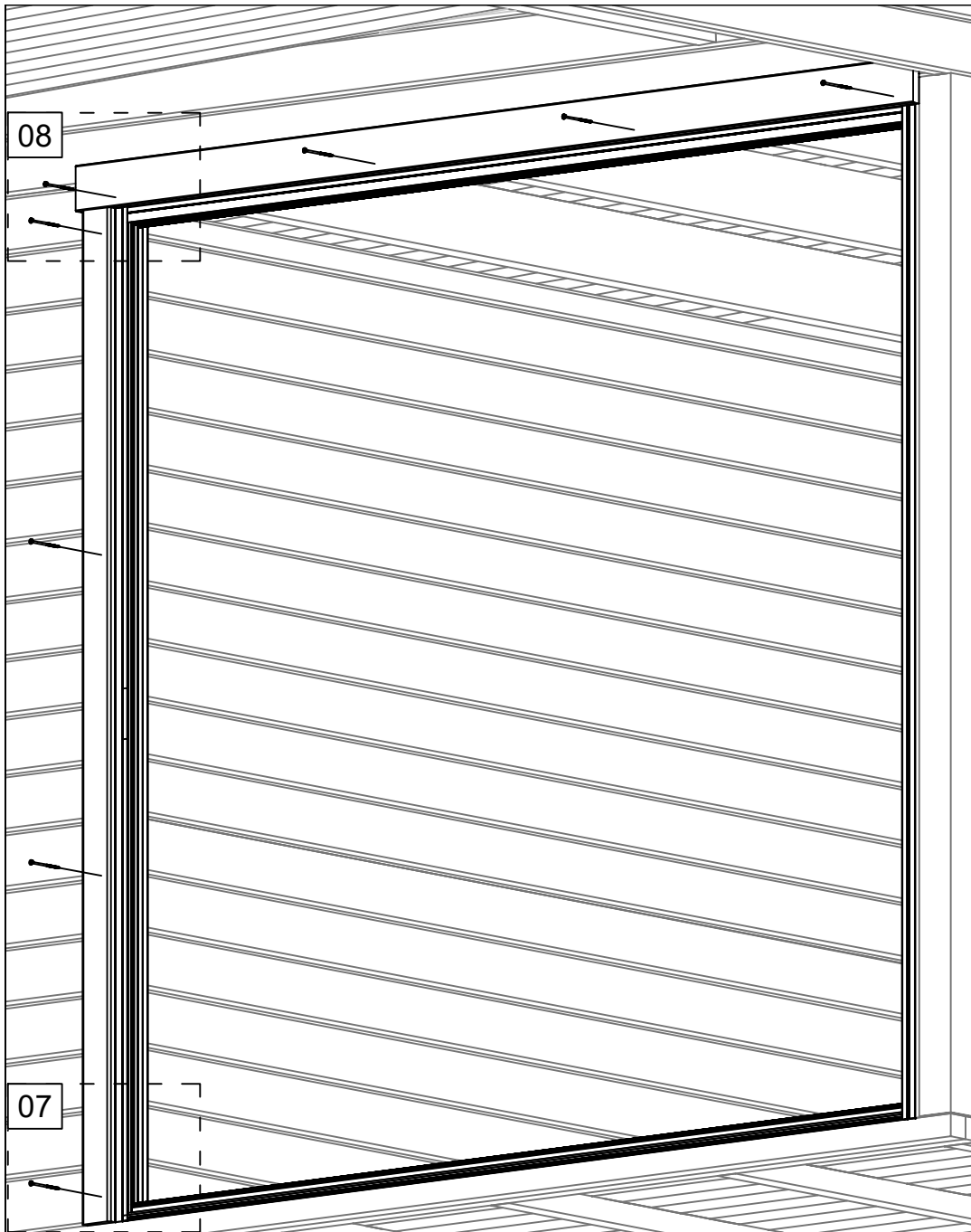

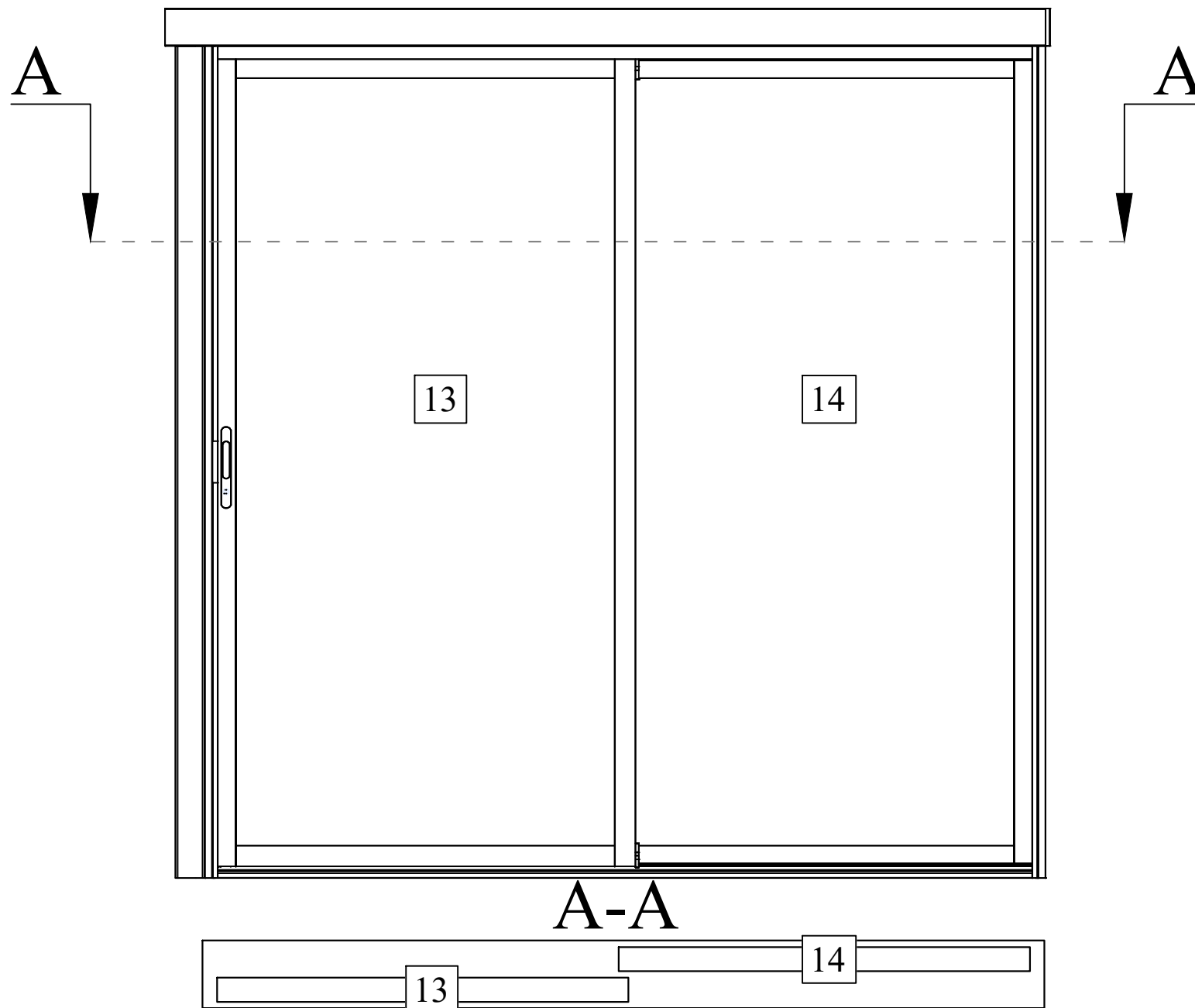

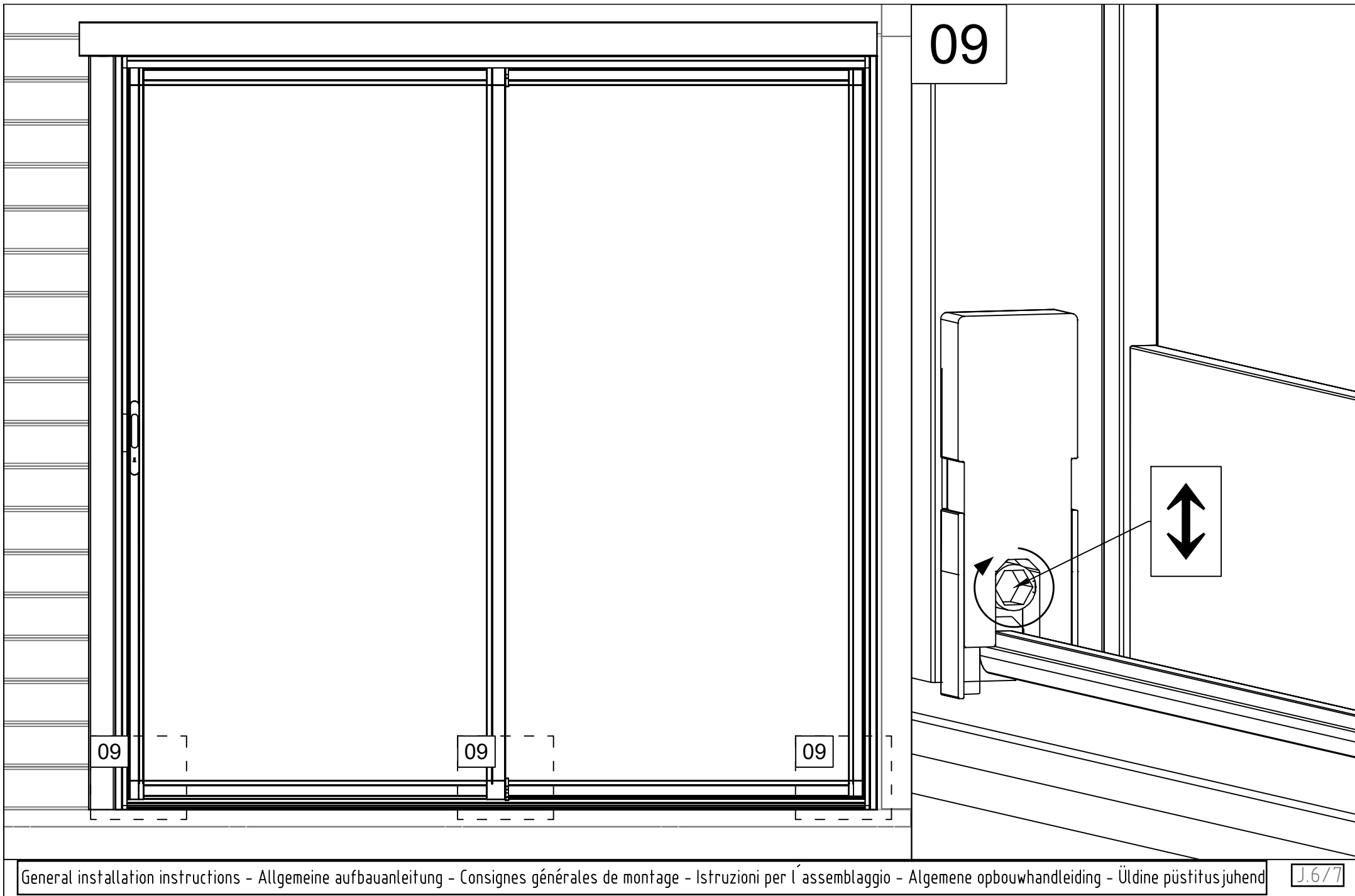

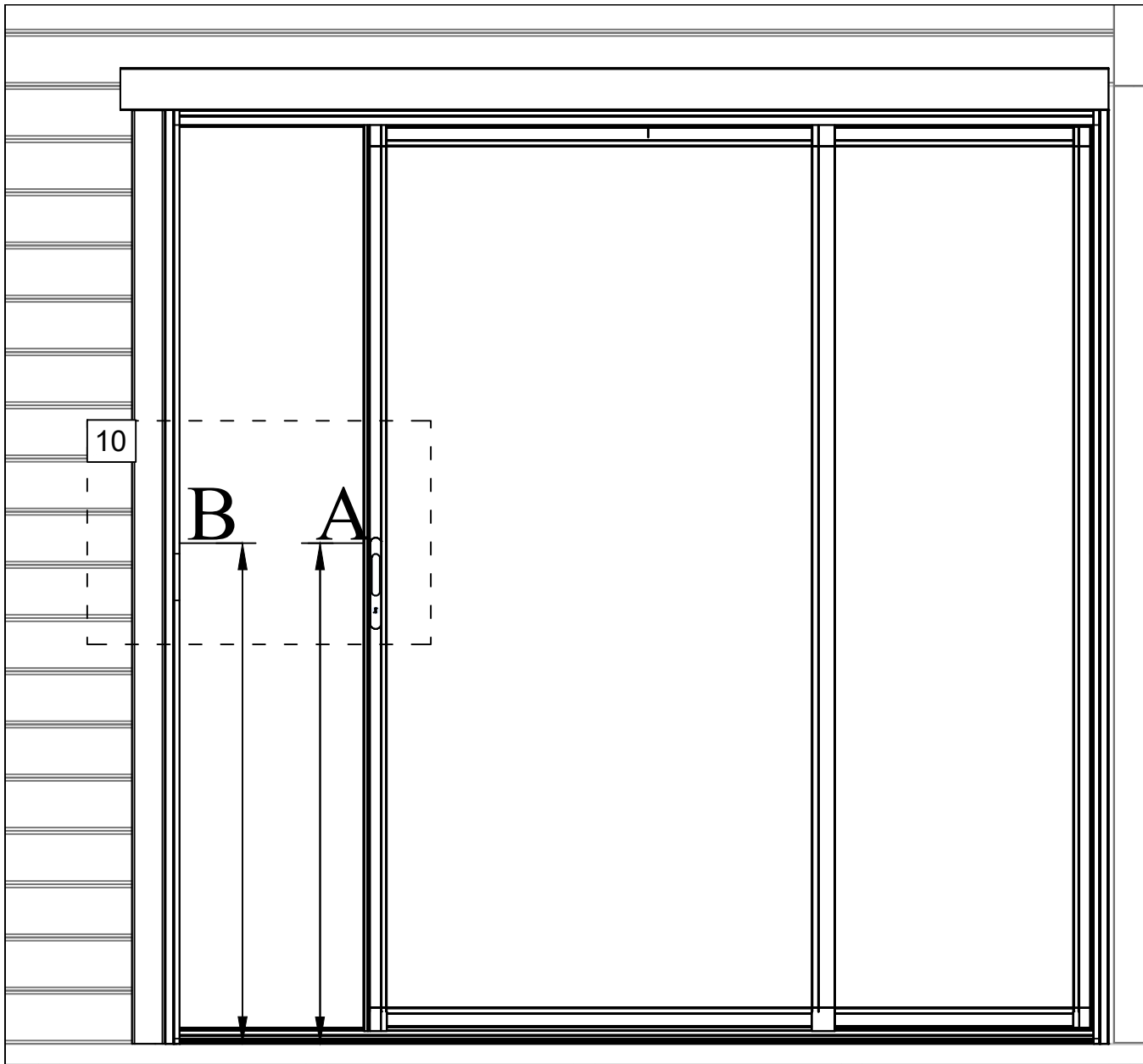

$$A=B$$

10

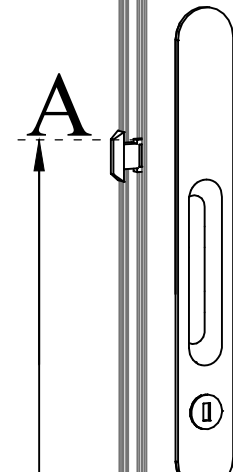

10

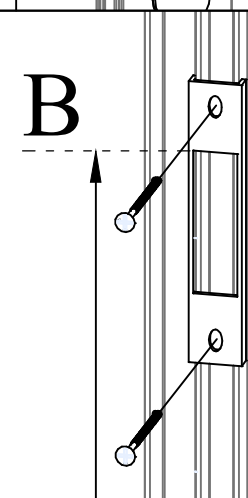

B



A

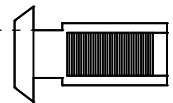

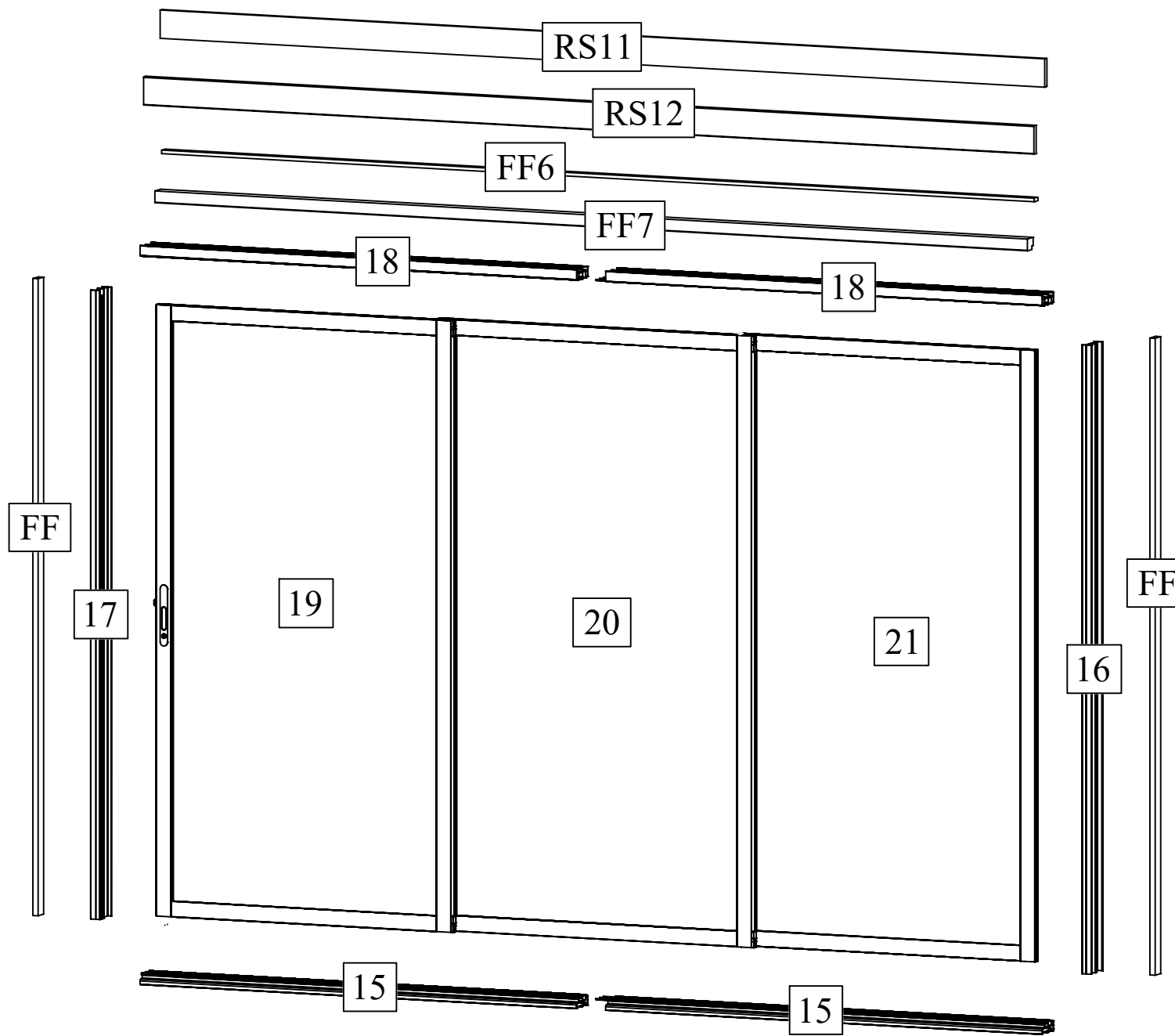



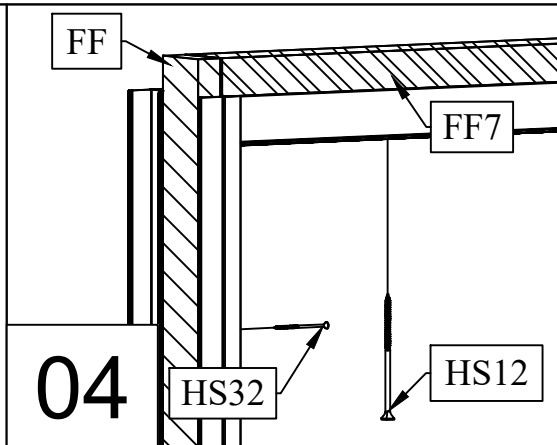
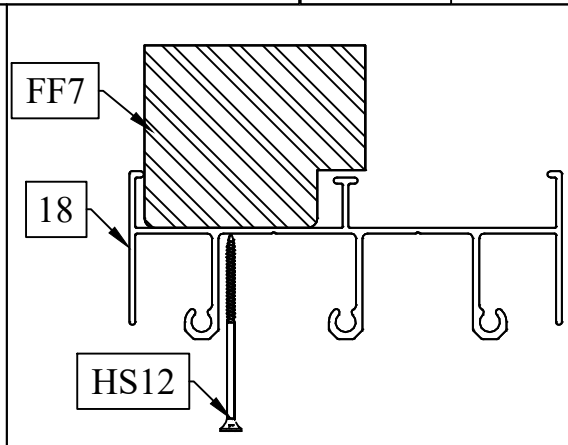
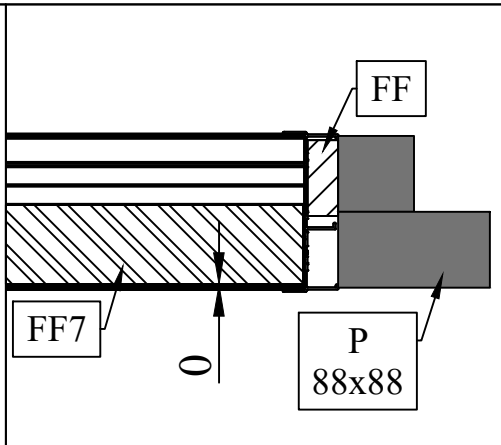
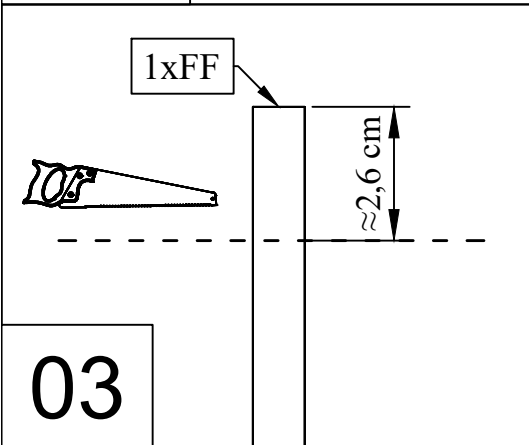
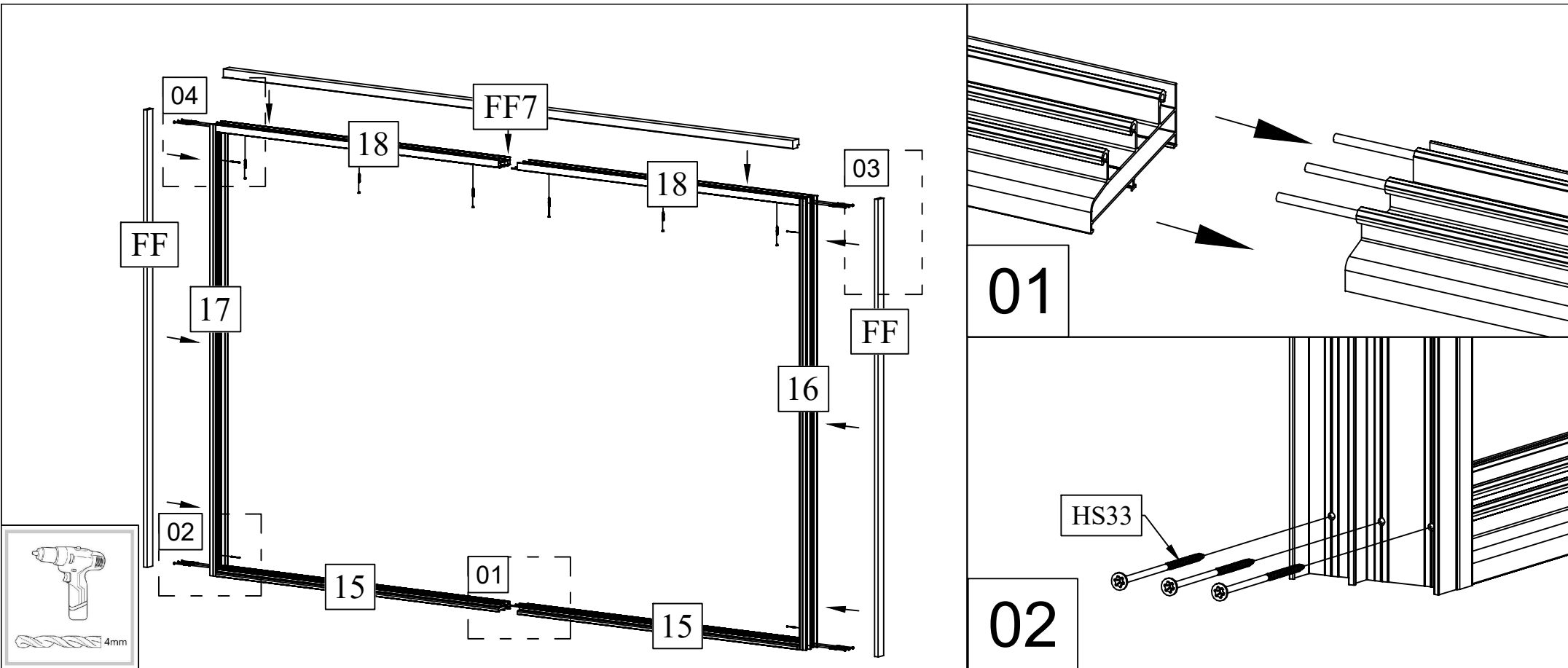

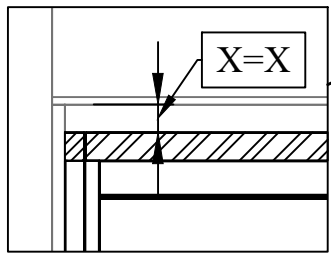

07

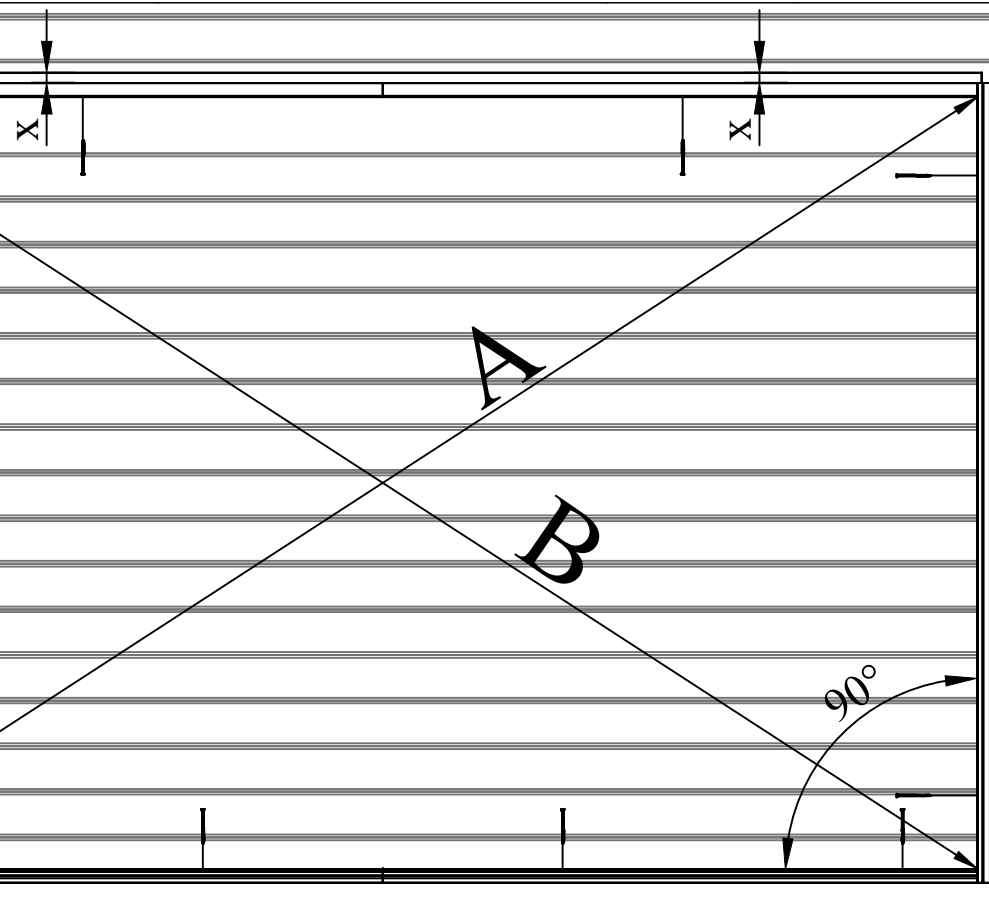

A=B

05-06

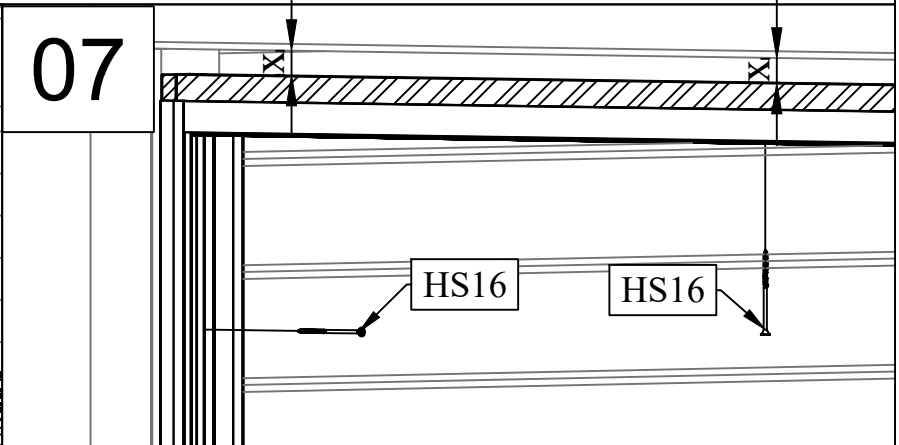
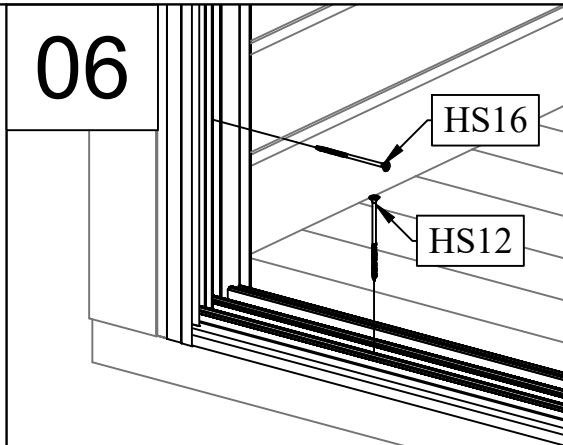
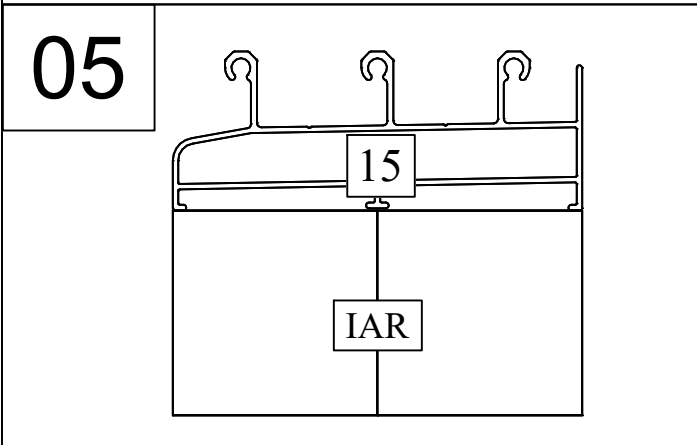

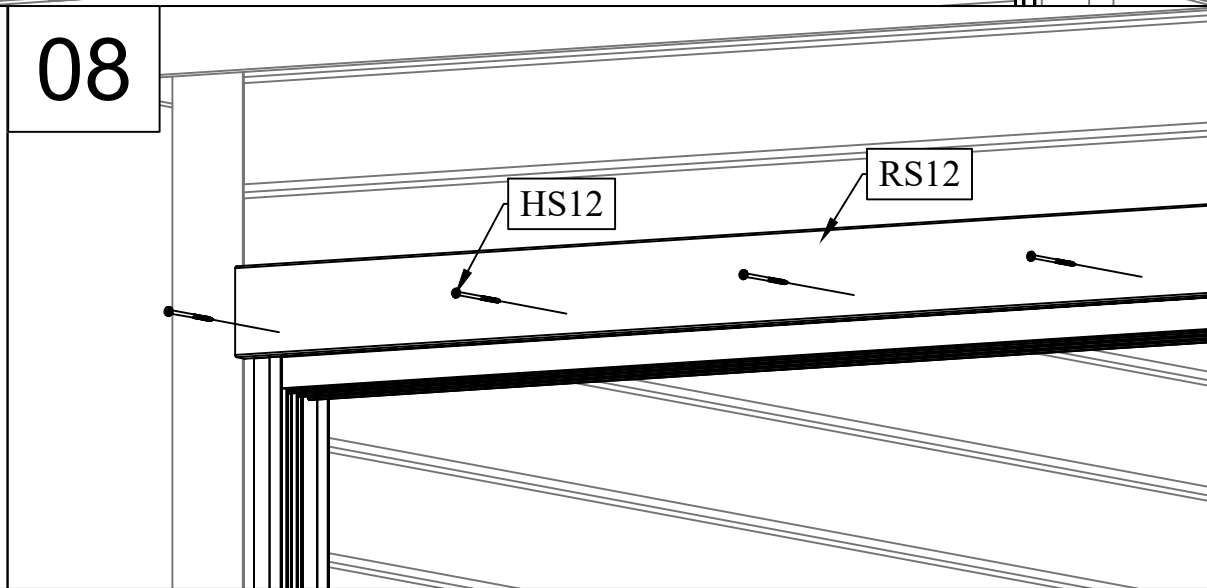
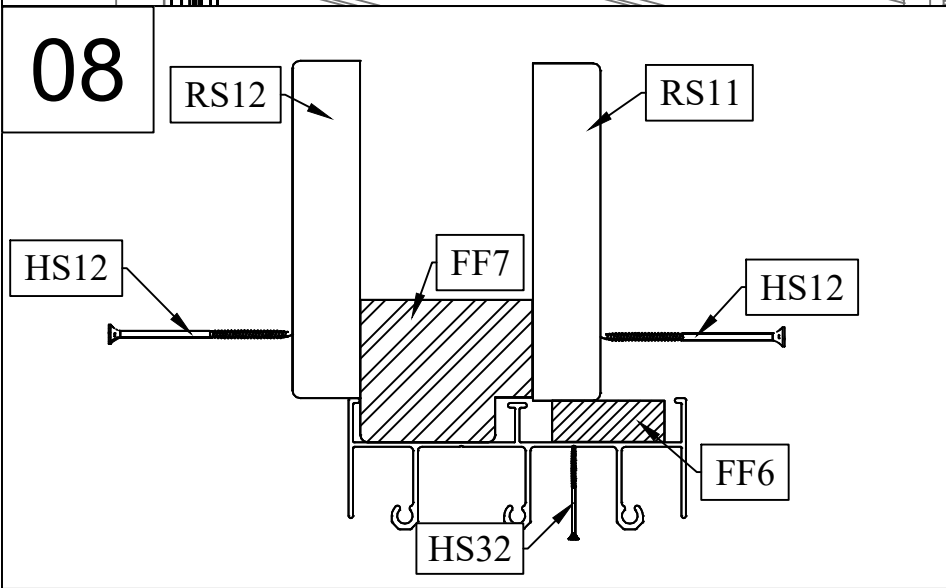
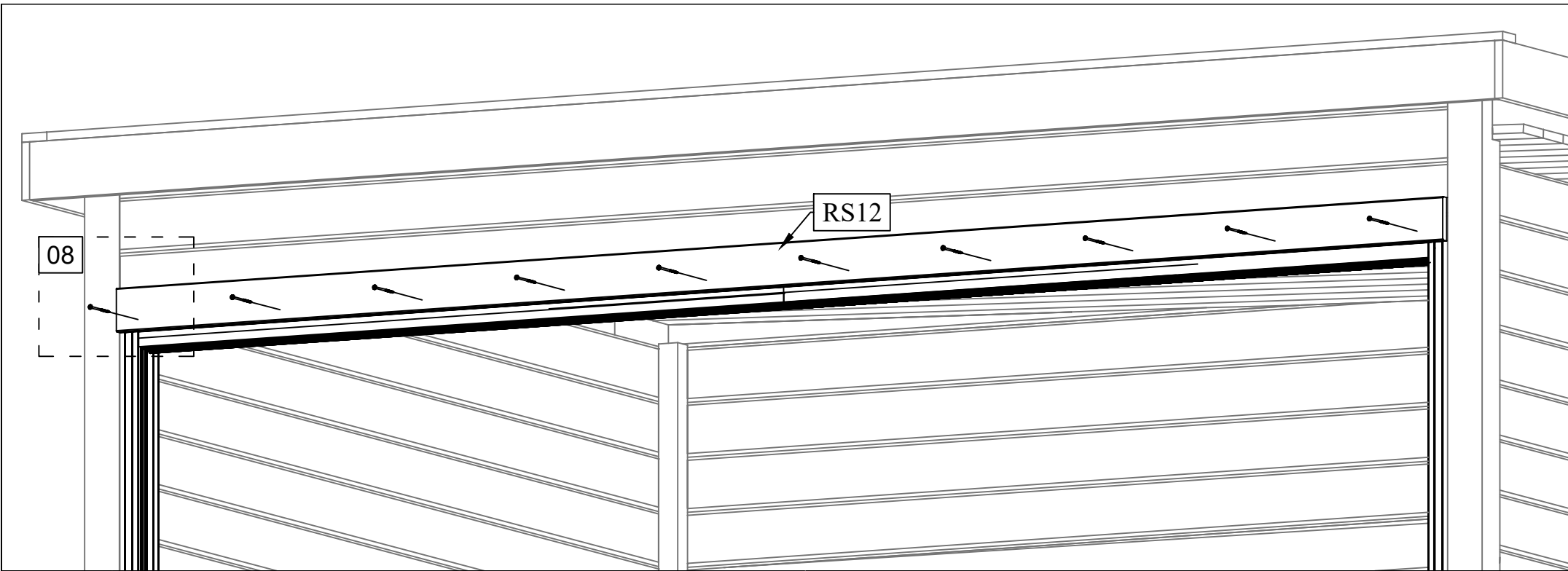

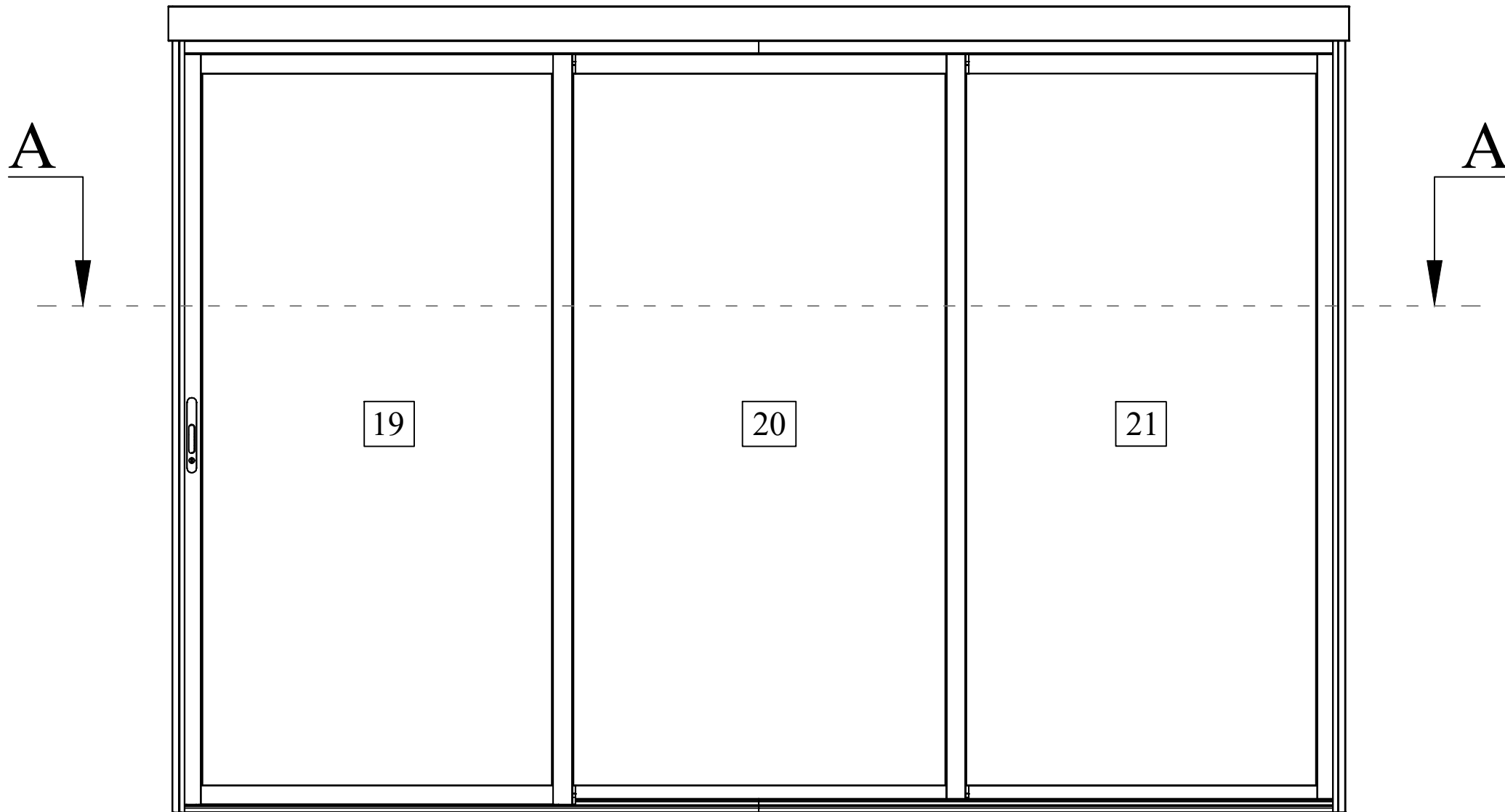

A-A

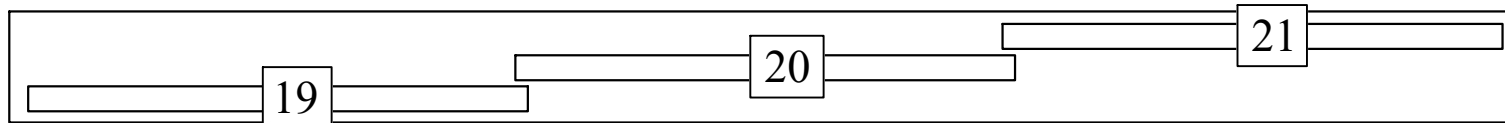

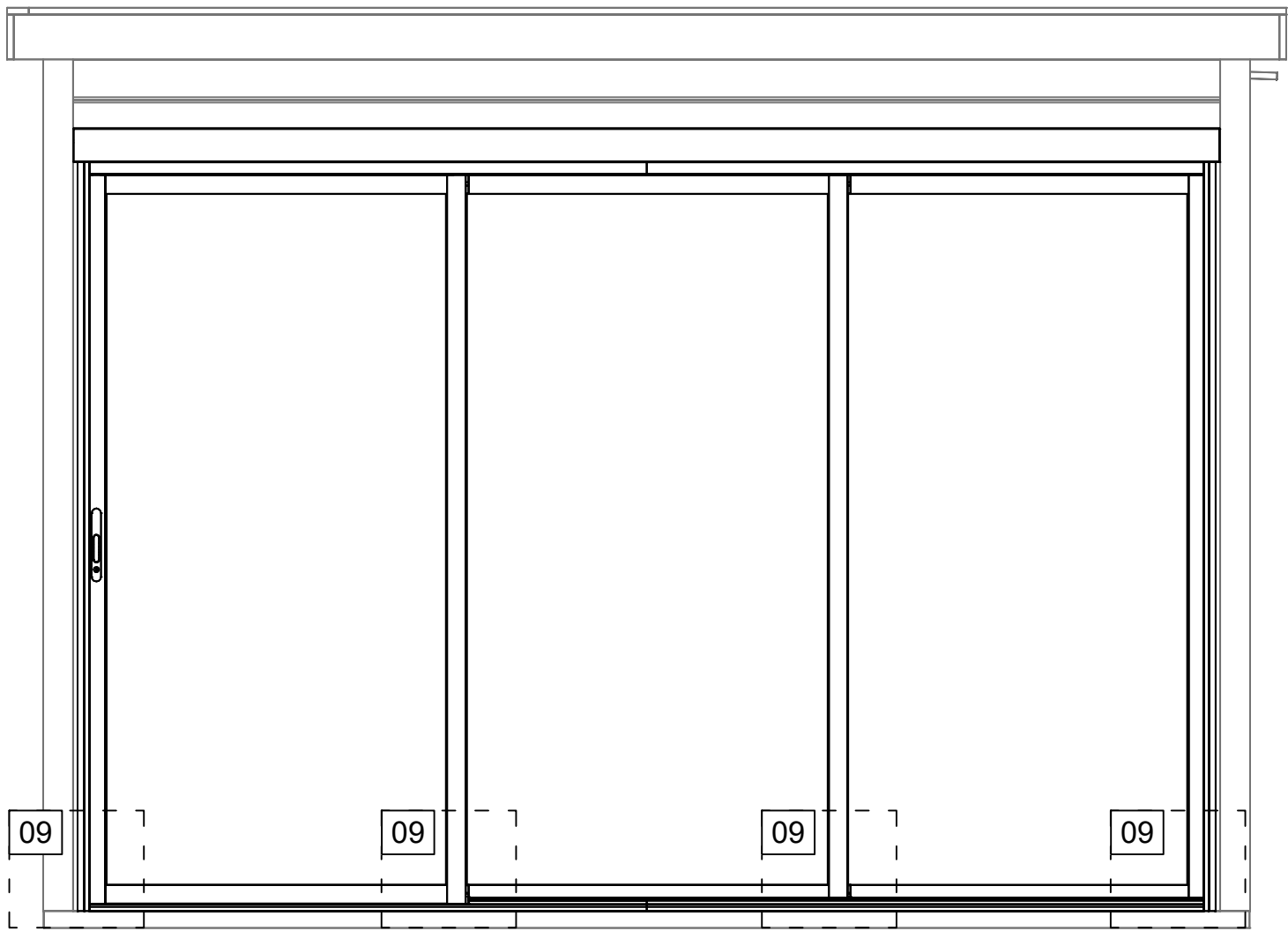

09

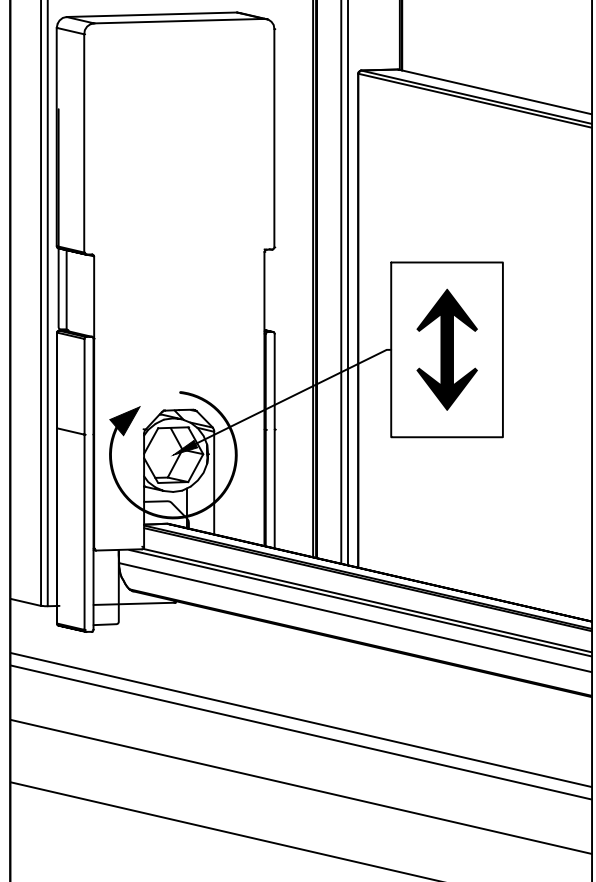

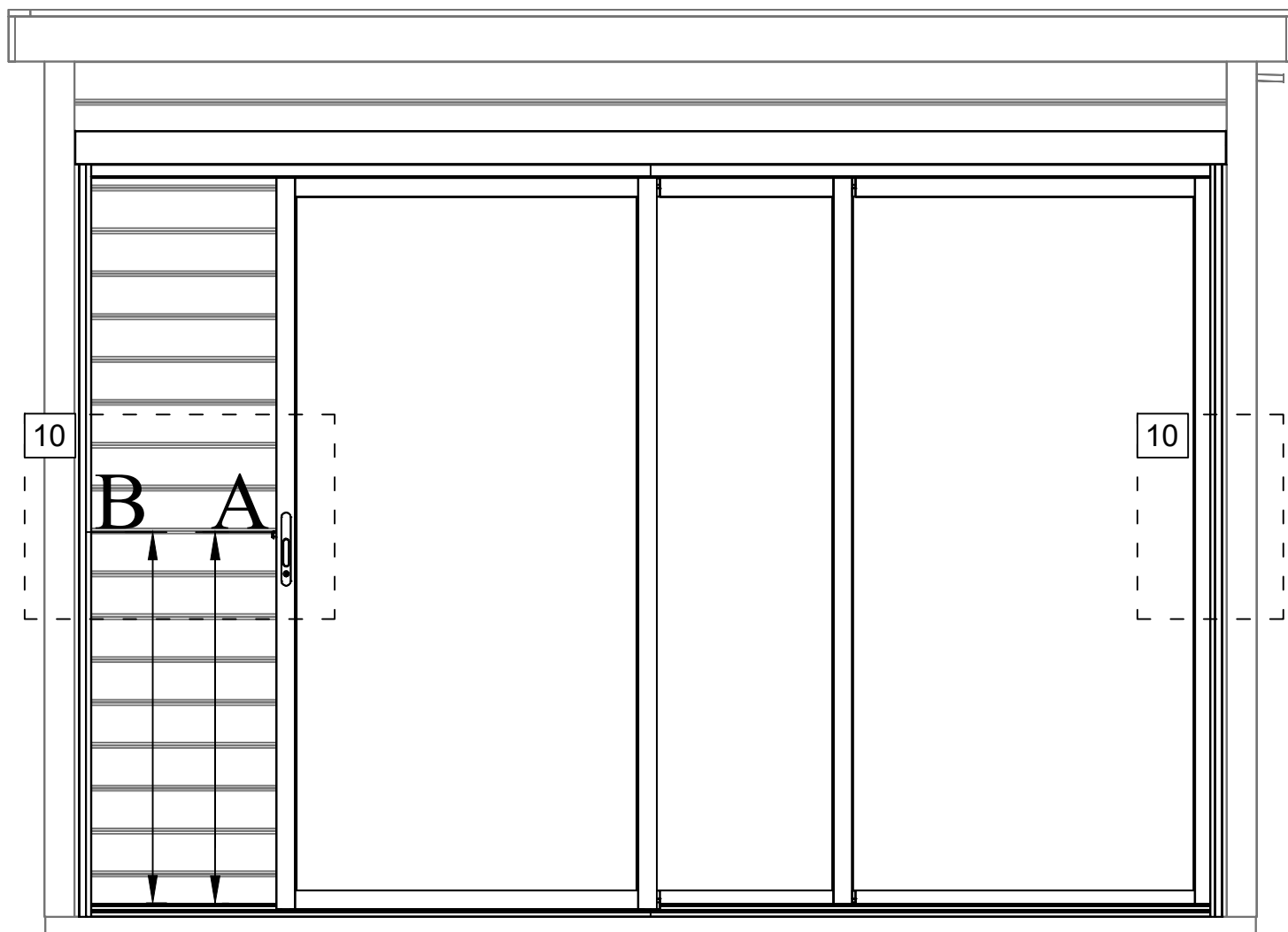

$$A=B$$

10

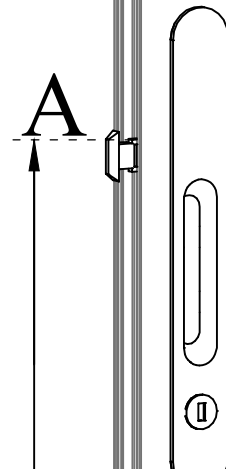

10

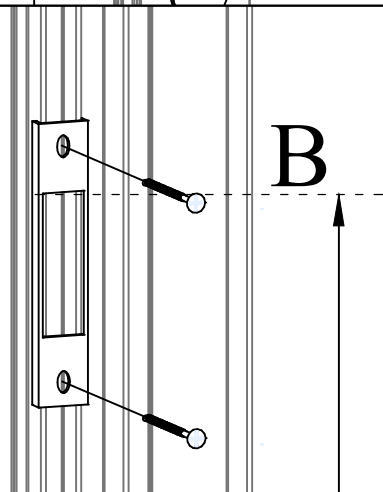

B

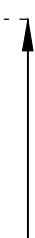

A

