

MONTAGEANLEITUNGEN

Artikelnummer: WF324844
WF324845
WF324846

Dieses Set ist in 3 Boxen enthalten. Wenn Sie keine vollen 3 Boxen erhalten, wenden Sie sich bitte an unseren Kundenservice
This set comes in 3 boxes. If you do not receive a full 3 boxes, please contact our customer service.

Hausbett 200x90cm

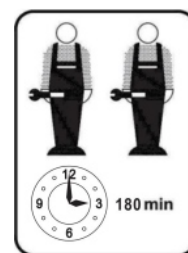
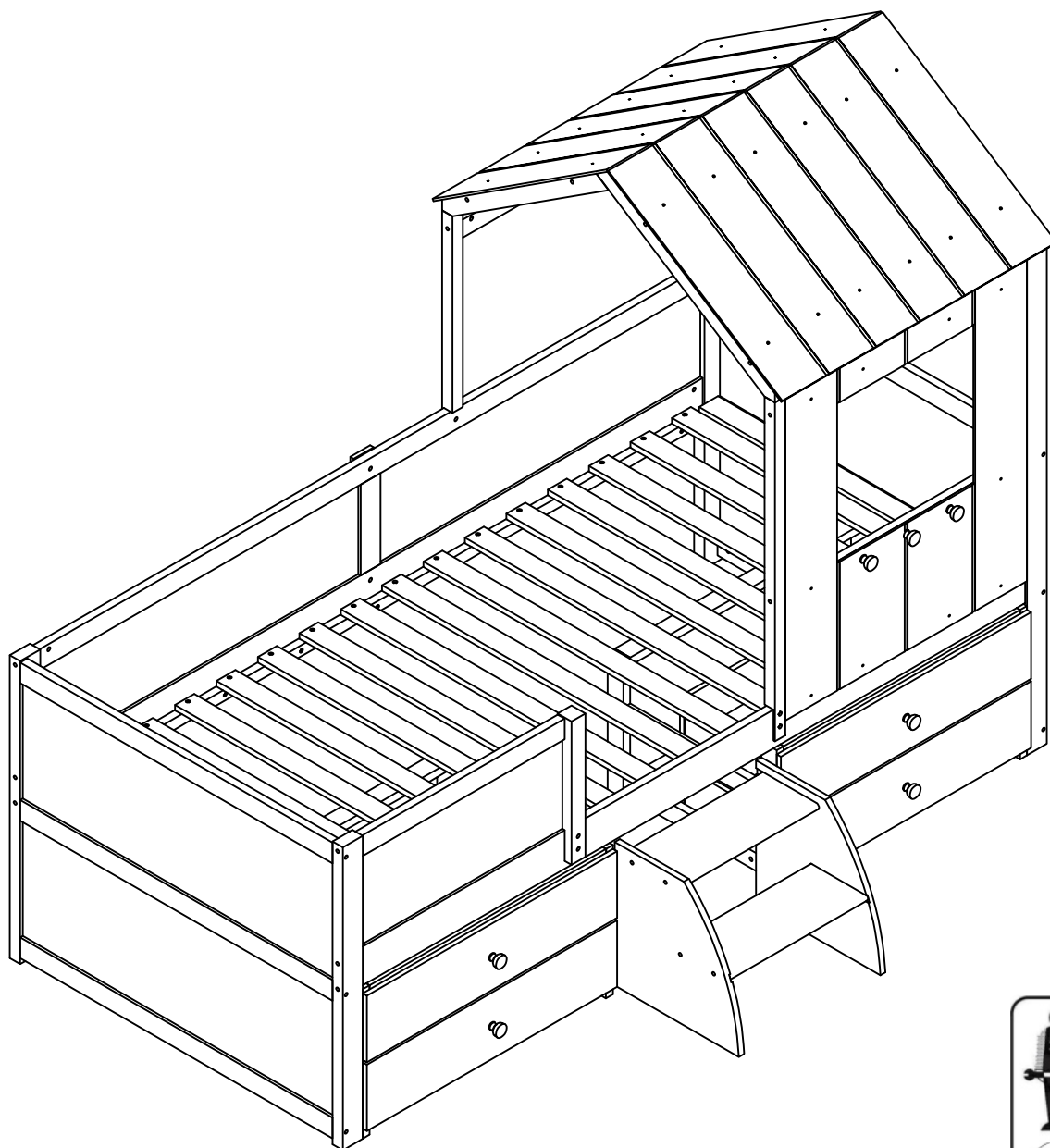

INSTRUCTIONS

IMPORTANT-READ CAREFULLY-RETAIN FOR FUTURE REFERENCE

- a) **WARNING**-High beds and the upper bed of bunk beds are not suitable for children under six years due to the risk of injury from falls;
- b) **WARNING**-Bunk beds and high beds can present a serious risk of injury from strangulation if not used correctly. Never attach or hang items to any part of the bunk bed that are not designed to be used with the bed, for example, but not limited to ropes, strings, cords, hooks, belts and bags.
- c) **WARNING**-Children can become trapped between the bed and the wall, a roof pitch, the ceiling adjoining pieces of furniture (e.g. cupboards) and the like. To avoid risk of serious injury the distance between the top safety barrier and the adjoining structure shall not exceed 75 mm or shall be more than 230 mm.
- d) **WARNING**-Do not use the bunk bed/high bed if any structural part is broken or missing; Replacement parts are between requested from the manufacturer or the store.
- e) it is imperative to always follow the installation instructions and manufacturer's use.
- f) The recommended size of the mattress to be used with the bed is **90x200**cm, maximum thickness mattress: **15cm**.
- g) It is necessary to ventilate the room in order to maintain a low level moisture and prevent mold growth in the bed and its periphery.
- h) Joining devices should always be tightened properly and regularly verified. Tighten if necessary.

ANLEITUNG

WICHTIG-SORGFÄLTIG DURCHLESEN-FÜR ZUKÜNFTIGE REFERENZ BEWAHREN

- a) **WARNUNG**-Das Oberbett von Etagenbett ist wegen der Verletzungsgefahr durch Stürze nicht für Kinder unter sechs Jahren geeignet.
- b) **WARNUNG**-Etagenbetten und Hochbetten können ein ernstes Verletzungsrisiko darstellen, wenn sie nicht ordnungsgemäß verwendet werden. Befestigen oder hängen Sie niemals etwas an einem Teil des Etagenbettes, das nicht für das Bett bestimmt ist, wie z. B. Seile, Haken, Gurte und Taschen.
- c) **WARNUNG**-Kinder können zwischen Bett und Wand eingeklemmt werden. Um die Gefahr schwerer Verletzungen zu vermeiden, darf der Abstand zwischen der oberen Sicherheitsbarriere und der angrenzenden Konstruktion 75 mm nicht überschreiten oder mehr als 230 mm betragen.
- d) **WARNUNG**-Verwenden Sie das Etagenbett nicht, wenn ein Bauteil beschädigt ist oder fehlt. Ersatzteile werden zwischendurch beim Hersteller oder beim Händler angefordert.
- e) Befolgen Sie unbedingt die Anweisung des Herstellers.
- f) Die empfohlene Größe der Matratze für das Bett beträgt **90x200cm**, maximale Dicke der Matratze: **15cm**.
- g) Es ist notwendig, den Raum zu lüften, um ein niedriges Feuchtigkeitsniveau aufrechtzuerhalten und das Wachstum von Schimmel im Bett und an dessen Peripherie zu verhindern.
- h) Verbindungselemente sollten immer richtig angezogen und regelmäßig überprüft werden. Bei Bedarf festziehen.



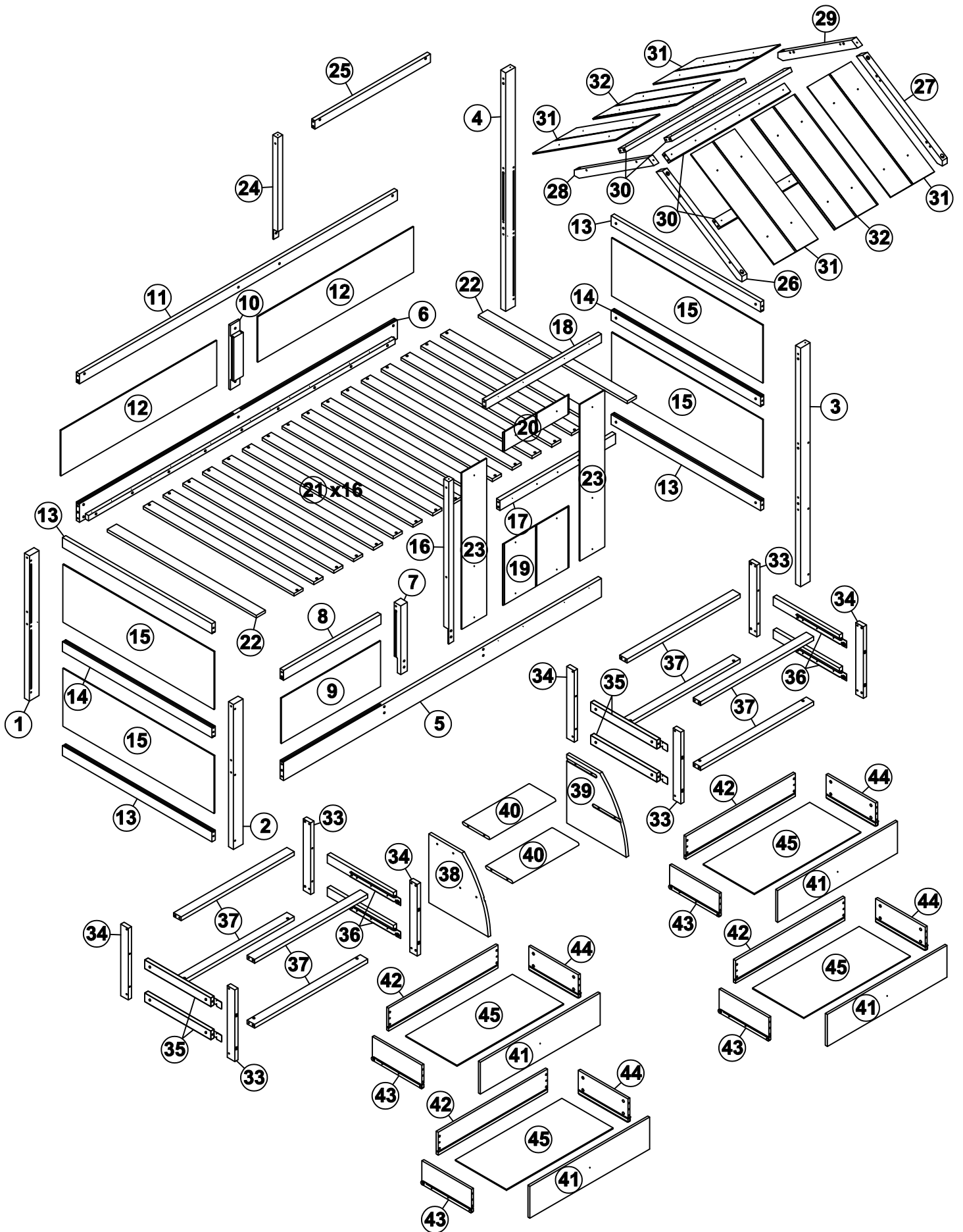





MONTAGEANLEITUNGEN

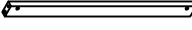

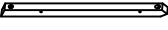
MONTAGEANLEITUNGEN

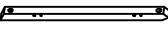
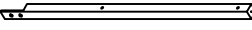
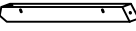
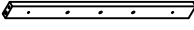
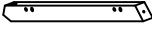
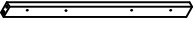
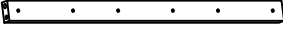
STÜCKLISTE



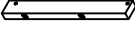
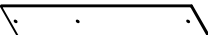
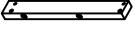
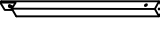
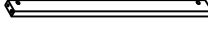



WF324844 (Hardware-in dieser SKU)

8	 Stange am Vorderbein Balustradenrahmen	1pc	25	 Rechtes vorderes Geländer	1pc
13	 Kopfteilrahmen	4pcs	26	 Dach - vordere Stütze	1pc
14	 Kopfteilrahmen	2pcs	27	 Dach - vordere Stütze	1pc
16	 Untere vordere Stütze des Daches	1pc	28	 Dach - hintere Stütze	1pc
17	 Rechtes vorderes Geländer	1pc	29	 Dach - hintere Stütze	1pc
18	 Rechtes vorderes Geländer	1pc	30	 Träger für Dachpaneele	4pcs
19	 Oberes Fensterpaneel	1pc	45	 Untere Schubladenplatte	4pcs
20	 Oberes Fensterpaneel	1pc	33	 Linkes Vorderbein & Rechtes Hinterbein	4pcs
23	 Oberes Fensterpaneel	2pcs	34	 Linkes Hinterbein & Rechtes Vorderbein	4pcs
24	 Untere hinterer Stütze des Daches	1pc	37	 Seitliche Schubladenrahmen	8pcs

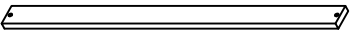
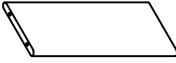
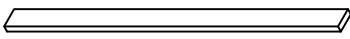
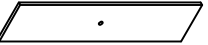
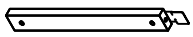
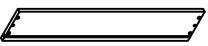





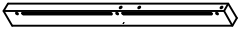

MONTAGEANLEITUNGEN

STÜCKLISTE

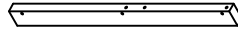
WF324845

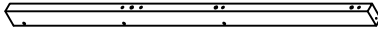
21	Latten 	16pcs	40	Bodenplatte der Aufbewahrungsleiter 	2pcs
22	Latten 	2pcs	41	Schubladenfronten 	4pcs
35	Unterstützung der seitlichen Schubladen 	4pcs	42	Schubladenrückwände 	4pcs
36	Unterstützung der seitlichen Schubladen 	4pcs	43	Schublade links 	4pcs
38	Aufbewahrungsleiter Seitenwand 	1pc	44	Schublade rechts 	4pcs
39	Aufbewahrungsleiter Seitenwand 	1pc			

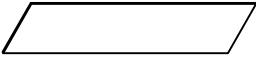
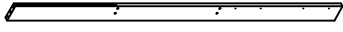

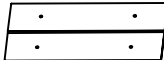
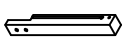
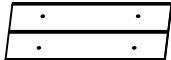













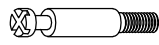





WF324846

1	Linkes Hinterbein 	1pc	9	Kopfteilrahmen 	1pc
2	Linkes Vorderbein 	1pc	10	Stützen der Hinterbein Leitplanken 	1pc
3	Rechtes Vorderbein 	1pc	11	Stange am Hinterbein Balustradenrahmen 	1pc
4	Rechtes Hinterbein 	1pc	12	Kopfteilplatte 	2pcs
5	Vorderer Seitenholm 	1pc	15	Kopfteilplatte 	4pcs
6	Hinterer Seitenholm 	1pc	31	Dachplatten 	4pcs
7	Stützen der Vordere Leitplanken 	1pc	32	Dachplatten 	2pcs

MONTAGEANLEITUNGEN

STÜCKLISTE

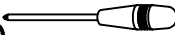
List der Hardware (WF324844)

A	Ø4x30		32PCS	M	6.5x60		4PCS
B	Ø4x15		8PCS	N	Ø10x40		38PCS
C	Ø4x20		34PCS	O	Ø8x30		16PCS
D	Ø4x35		3PCS	P	Ø6.5x35		32PCS
E	Ø4x25		4PCS	Q	Ø12x10		32PCS
F	1/4x100		14PCS	R	15x15x2		4PCS
G	1/4x90		17PCS	S	4x58		1PC
H	1/4x75		23PCS	T	Ø28x27 (N)		3PCS
I	1/4x60		24PCS	U	Ø28x27 (W)		4PCS
J	1/4x35		2PCS	V	Ø3.5x12 (W)		8PCS
K	1/4x25		5PCS	Benötigte Werkzeuge (nicht von uns gestellt)			
L	6.5x80		2PCS				

MONTAGEANLEITUNGEN

Schritt 1

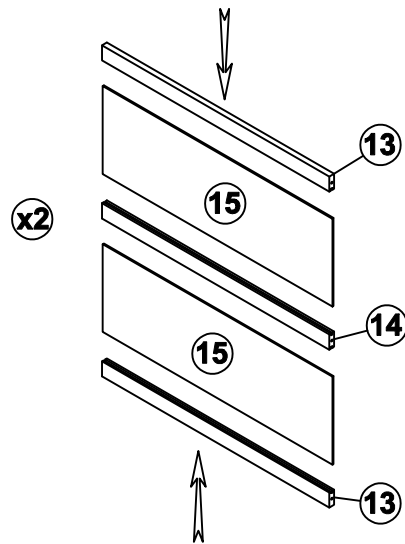

Schritt 2

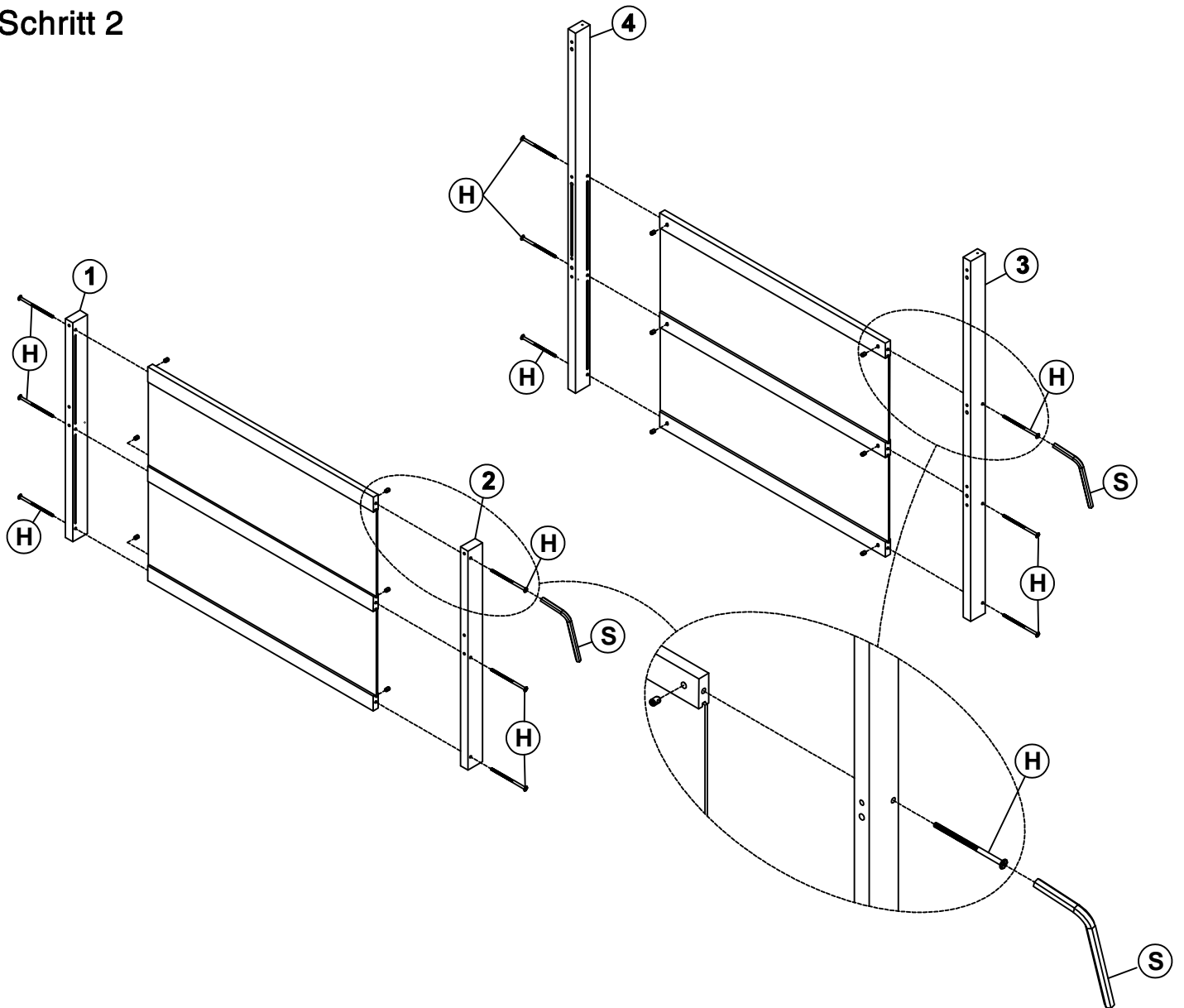

H 1/4x75



12PCS

S 4x58





1PC

MONTAGEANLEITUNGEN

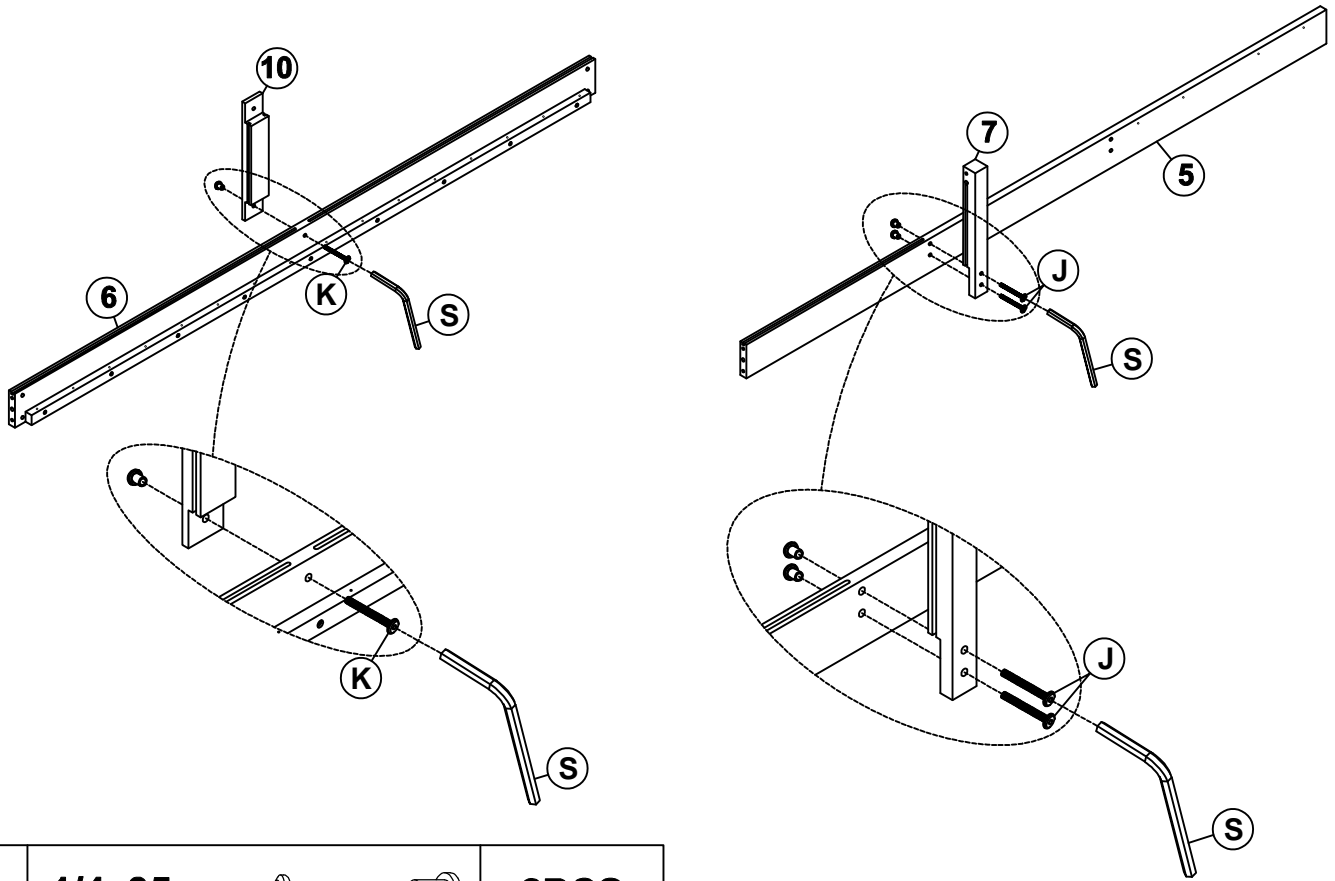
Schritt 3



J	1/4x35		2PCS				
K	1/4x25		1PC	S	4x58		1PC



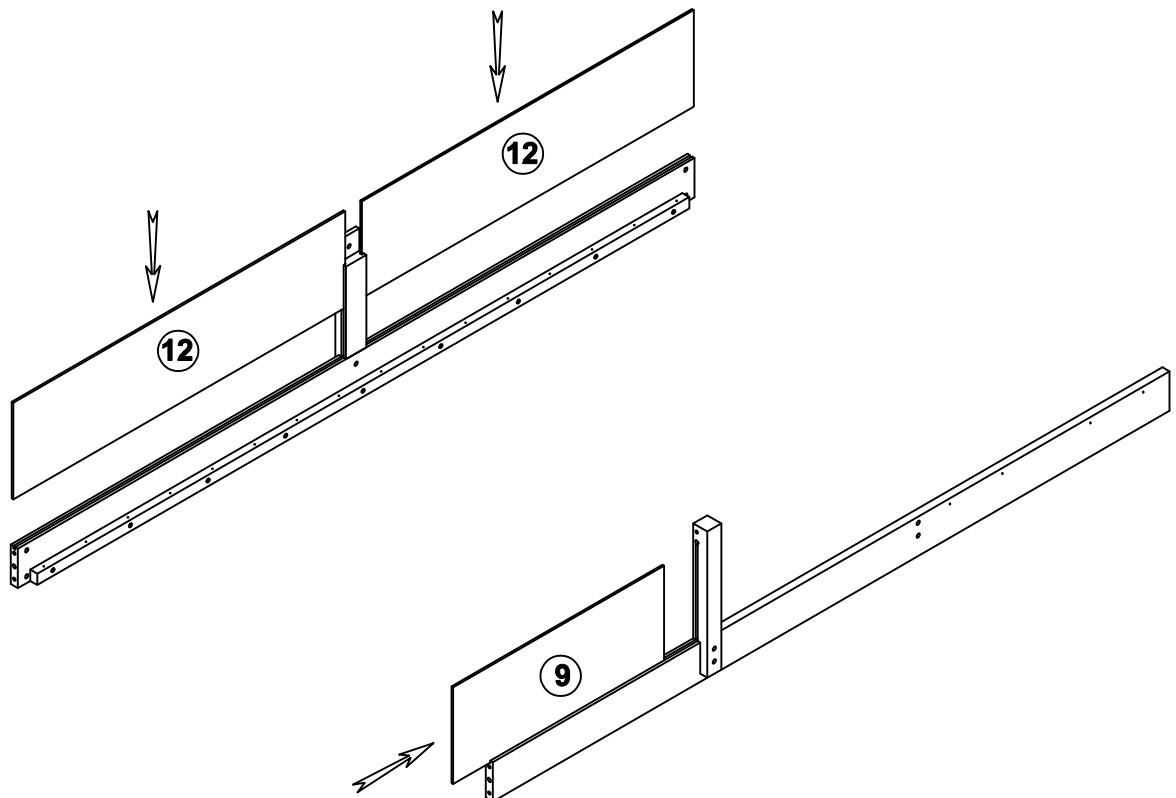

Schritt 4

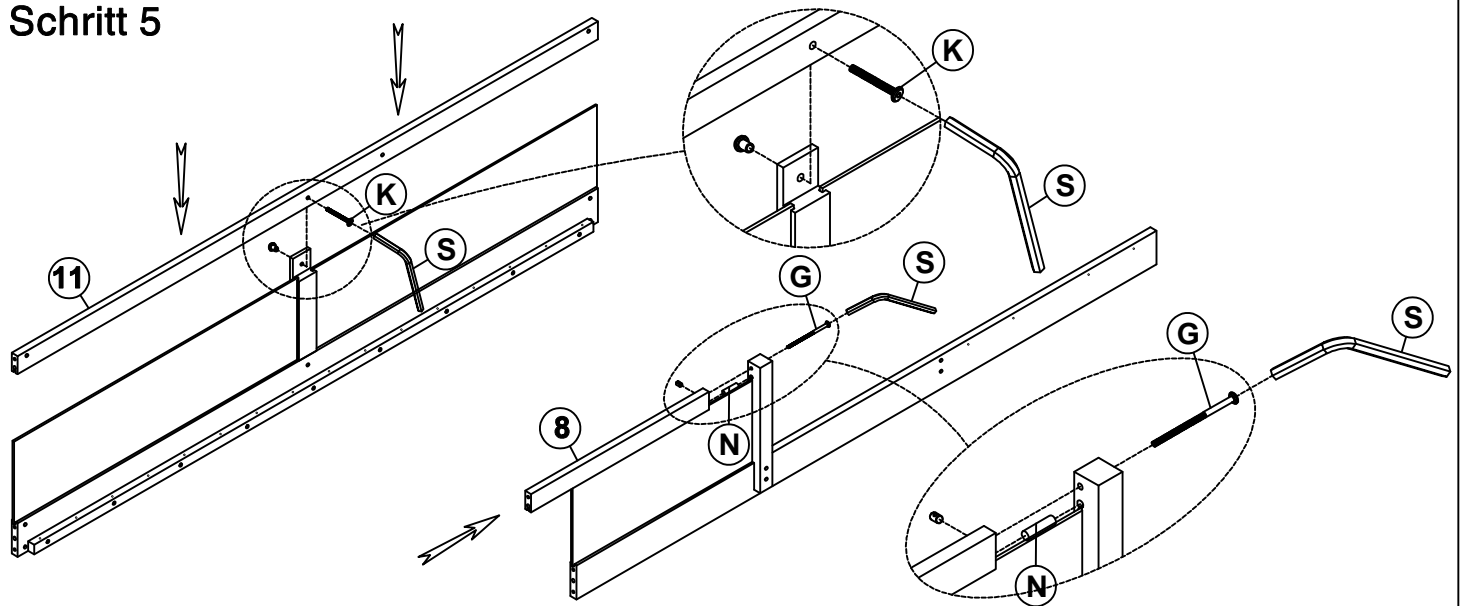

MONTAGEANLEITUNGEN

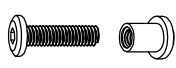

Schritt 5

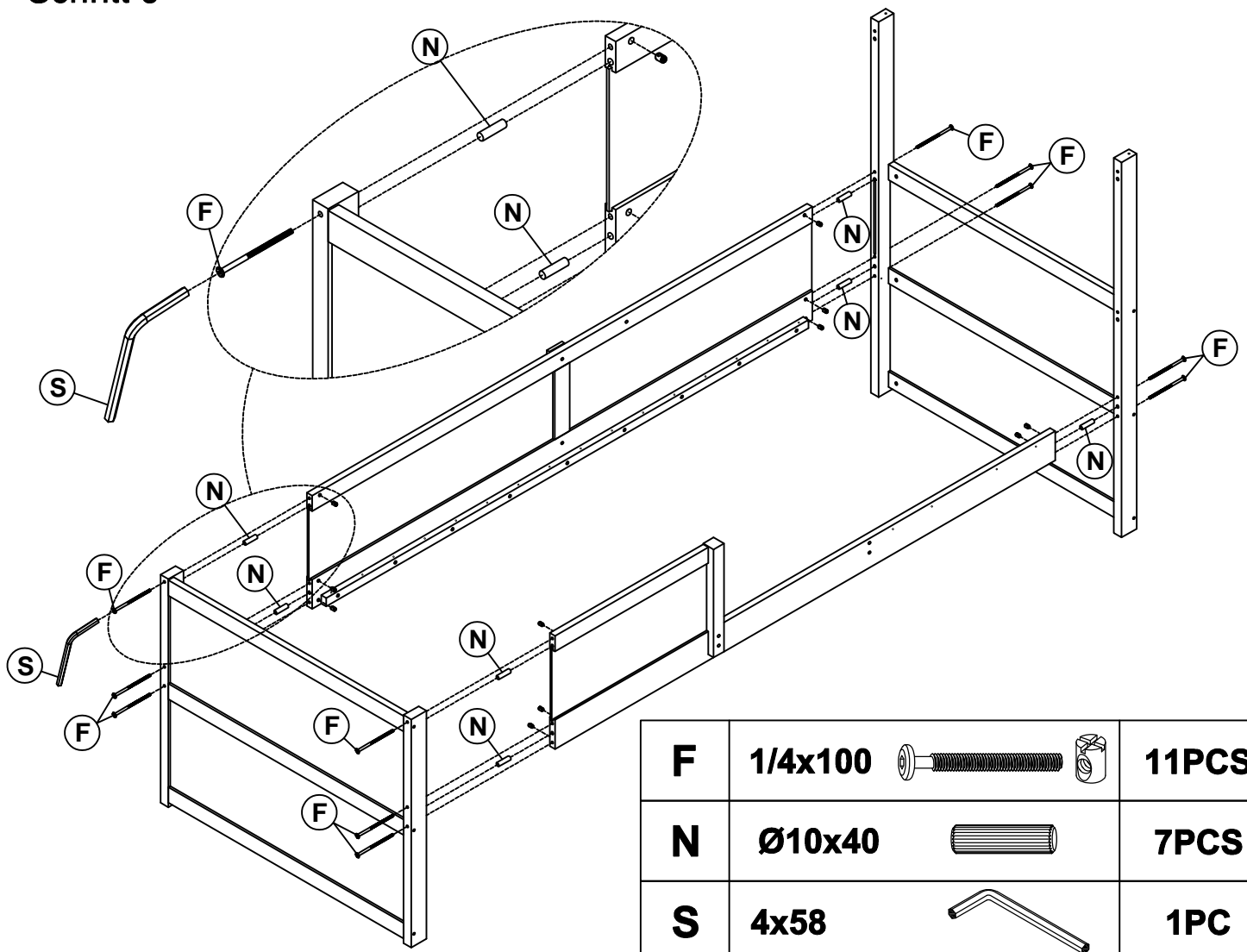

G	1/4x90		1PC	N	Ø10x40		1PC
K	1/4x25		1PC	S	4x58		1PC

Schritt 6

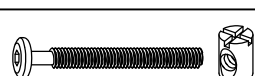



F	1/4x100		11PCS
N	Ø10x40		7PCS
S	4x58		1PC

MONTAGEANLEITUNGEN

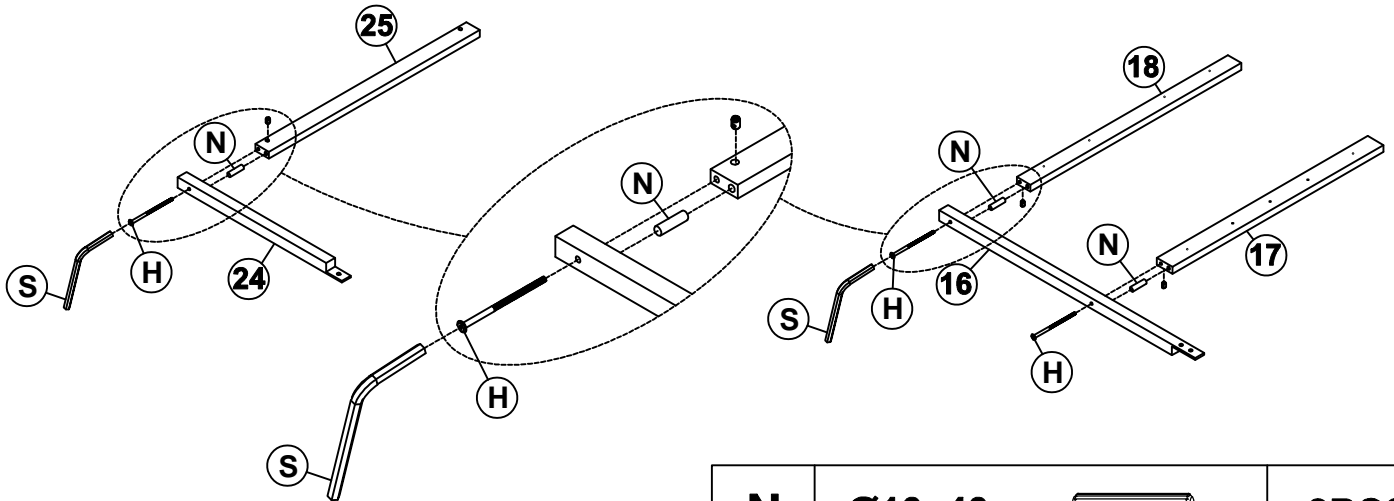



Schritt 7

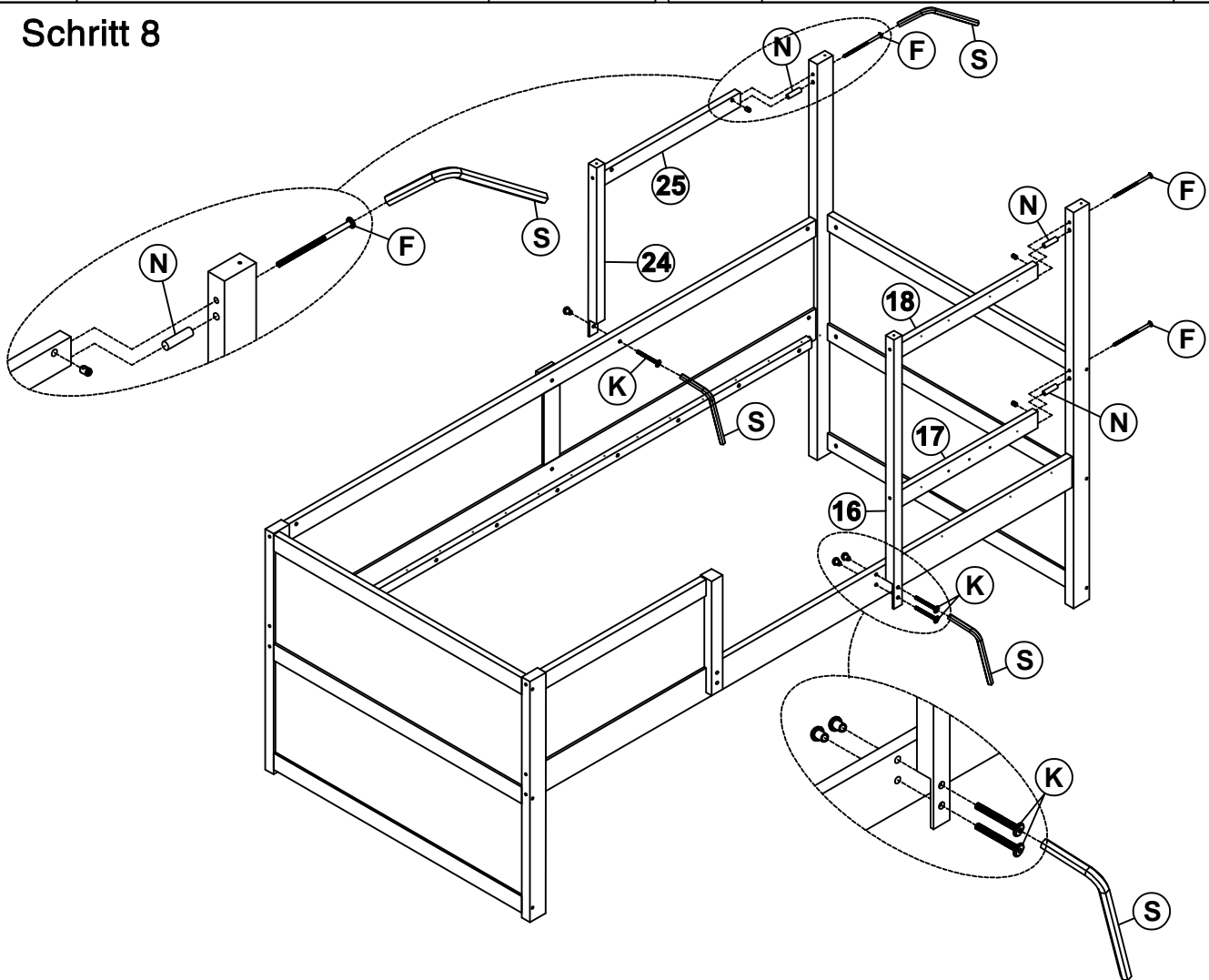

	N	$\text{Ø}10 \times 40$		3PCS			
H	$1/4 \times 75$		3PCS	S	4×58		1PC

Schritt 8





F	$1/4 \times 100$		3PCS	K	$1/4 \times 25$		3PCS
N	$\text{Ø}10 \times 40$		3PCS	S	4×58		1PC

MONTAGEANLEITUNGEN

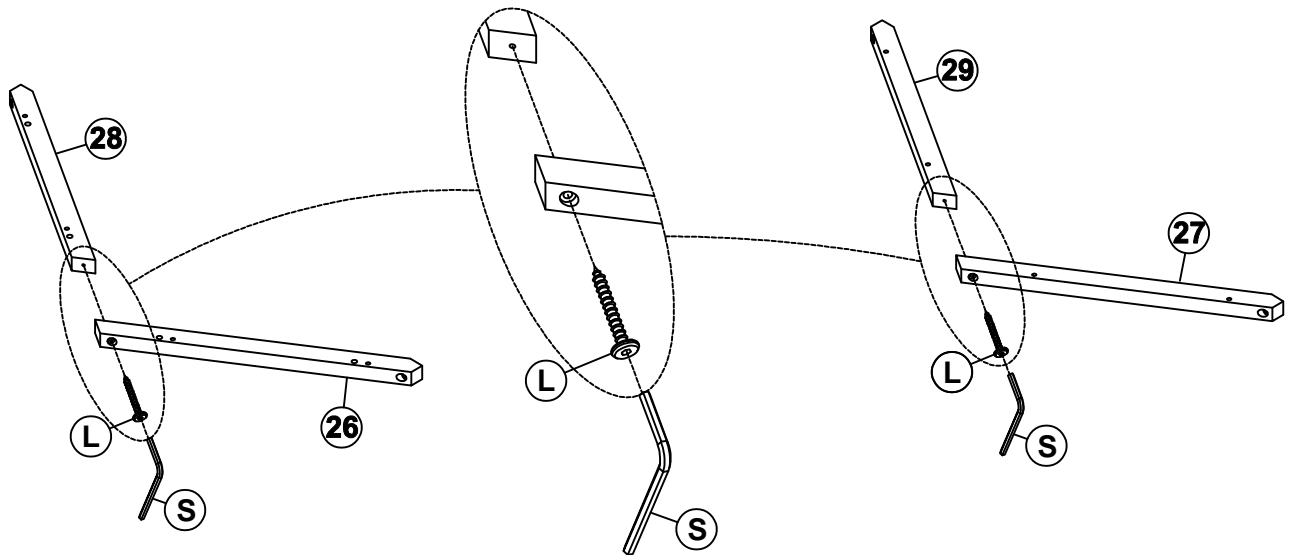



Schritt 9

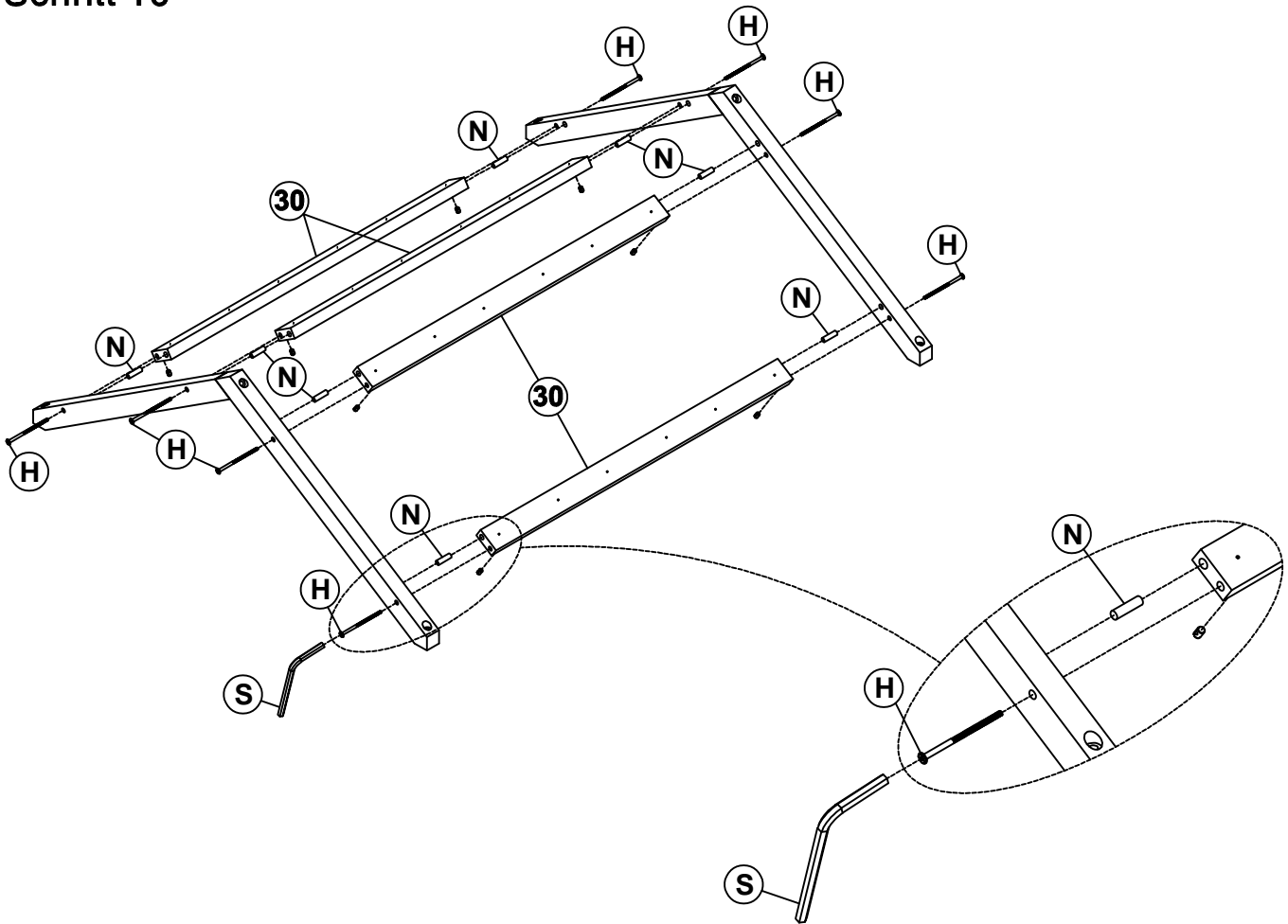

L	6.5x80		2PCS	S	4x58		1PC
----------	---------------	---	-------------	----------	-------------	---	------------

Schritt 10





H	1/4x75	 	8PCS	N	Ø10x40		8PCS	S	4x58		1PC
----------	---------------	---	-------------	----------	---------------	---	-------------	----------	-------------	---	------------

MONTAGEANLEITUNGEN

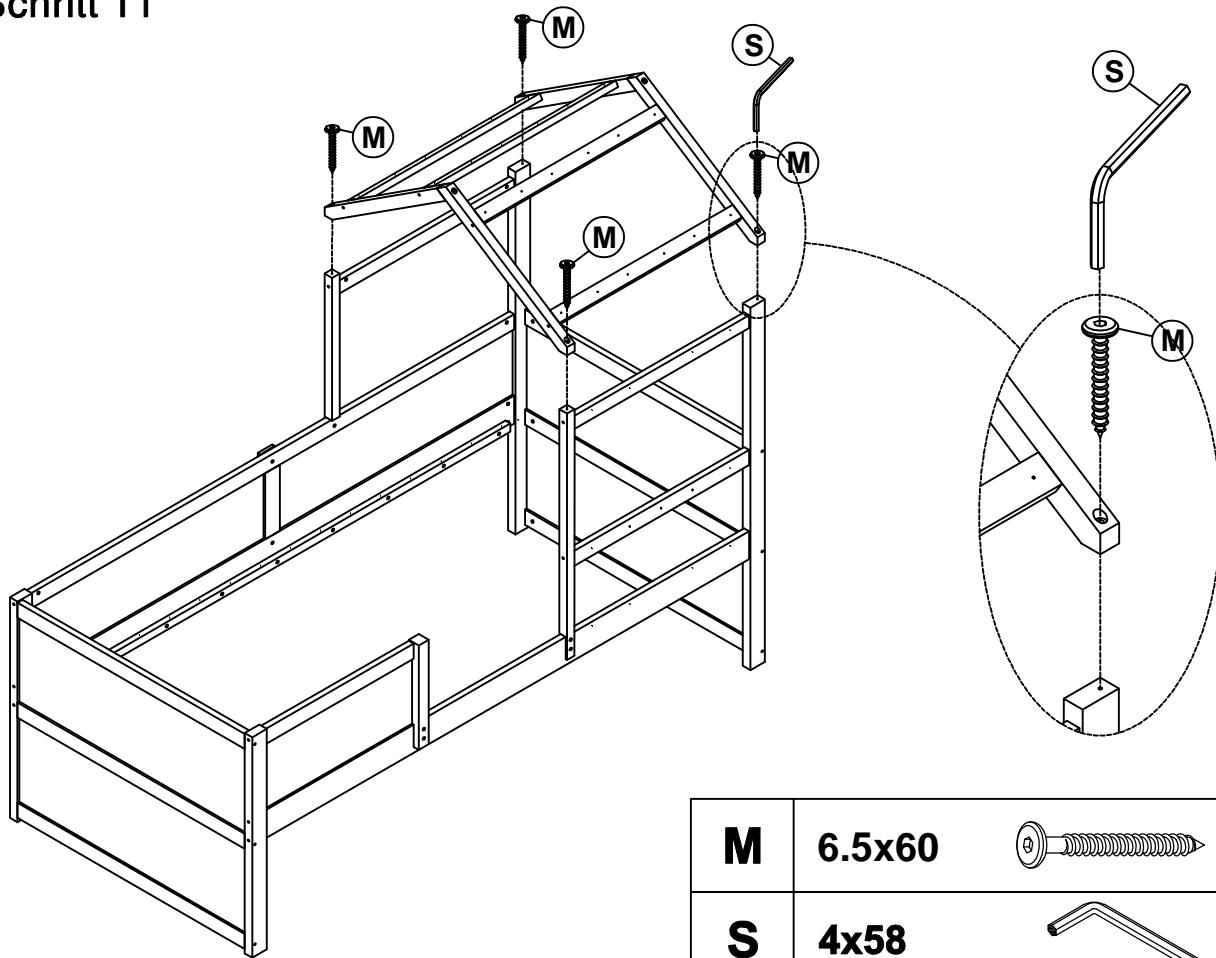

Schritt 11

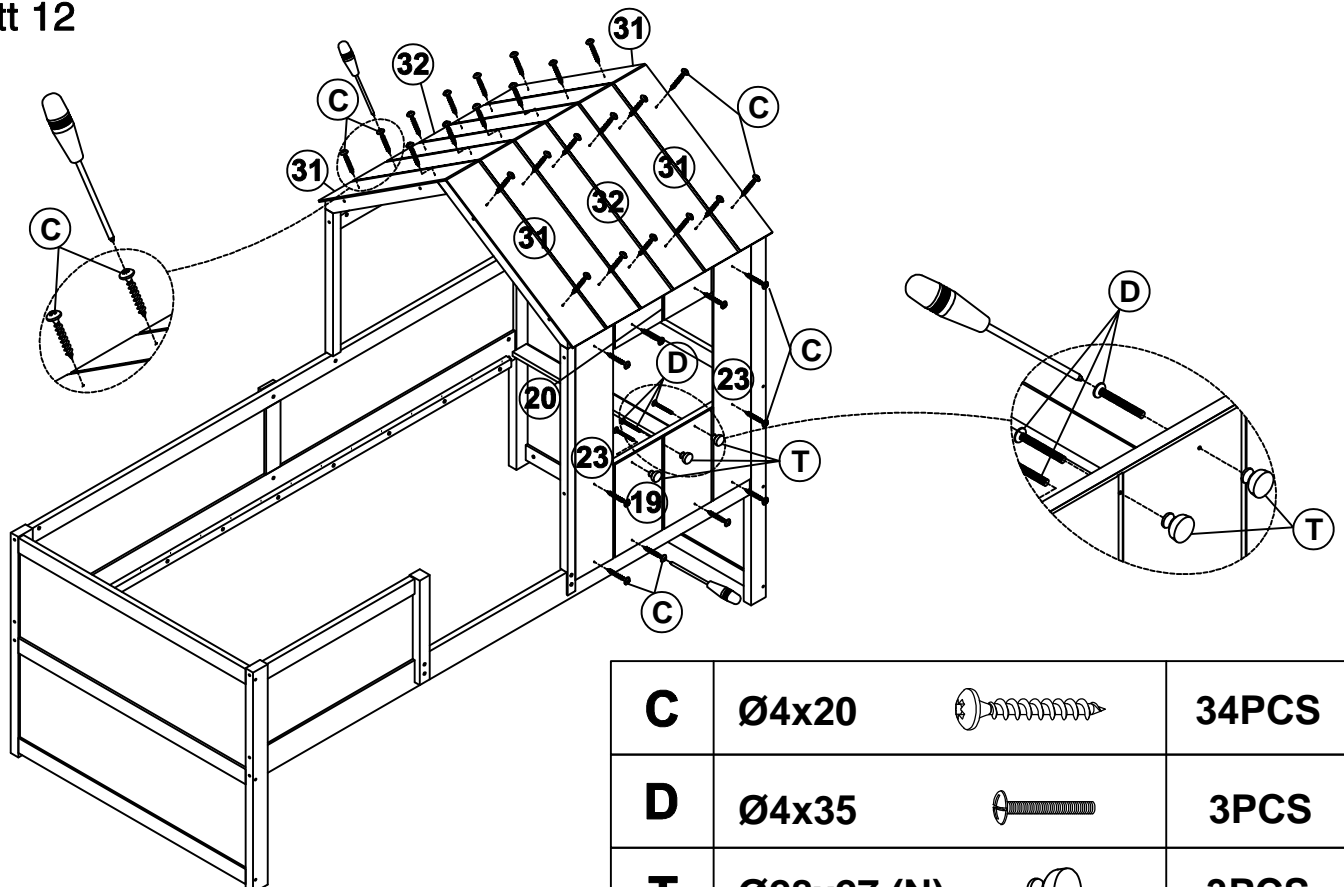

M	6.5x60		4PCS
S	4x58		1PC

Schritt 12



C	Ø4x20		34PCS
D	Ø4x35		3PCS
T	Ø28x27 (N)		3PCS

MONTAGEANLEITUNGEN

Schritt 13

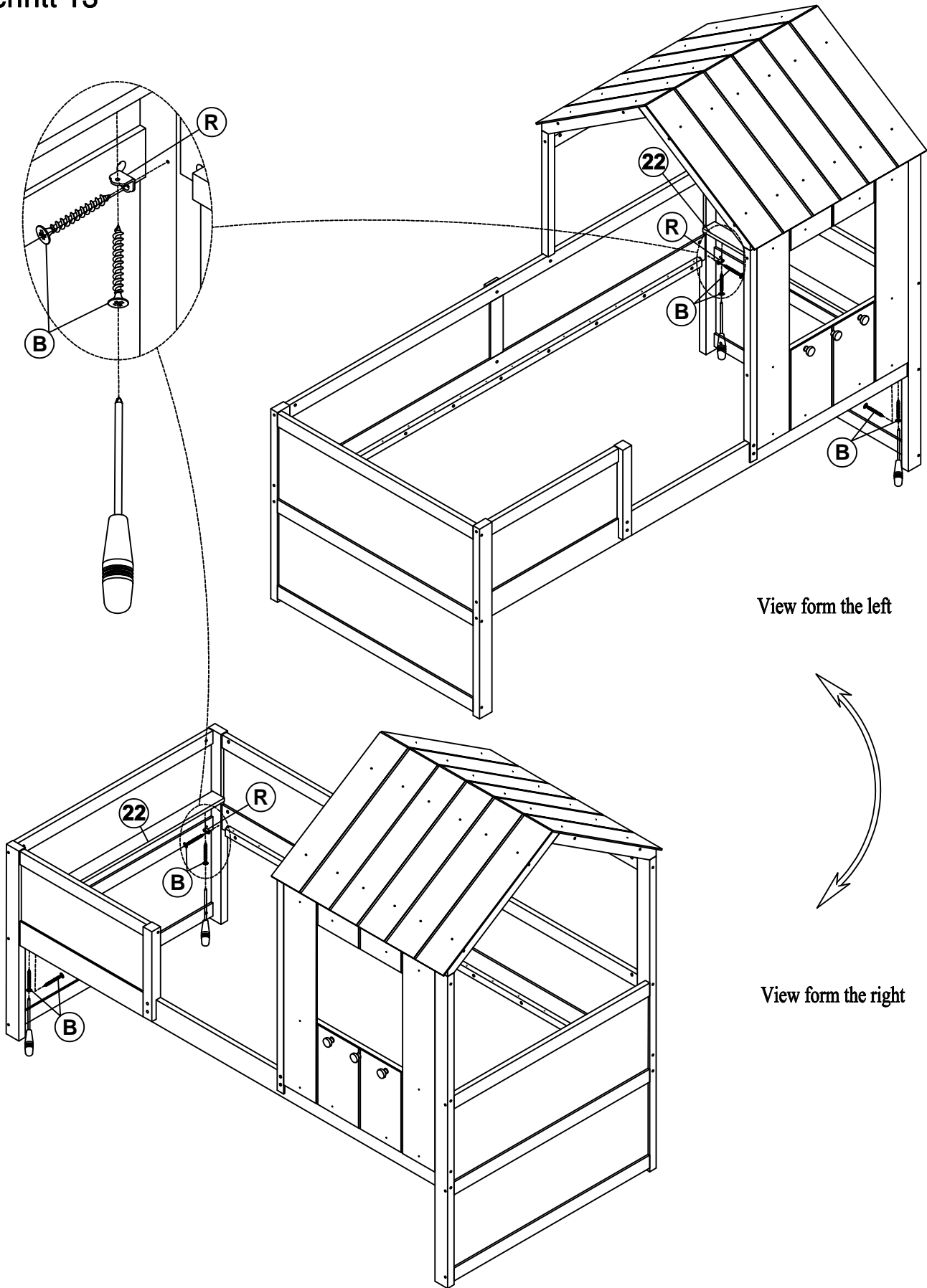

View from the left

View from the right

B Ø4x15



8PCS

R 15x15x2



4PCS

MONTAGEANLEITUNGEN

Schritt 14

Befestigen Sie zunächst 2 Stück von Teil 21 an der Vorderseite und am Ende des Rahmens zwischen dem Kopfteil.
Dann befestigen Sie das restliche Teil 21 gleichmäßig zwischen dem Kopfteil.

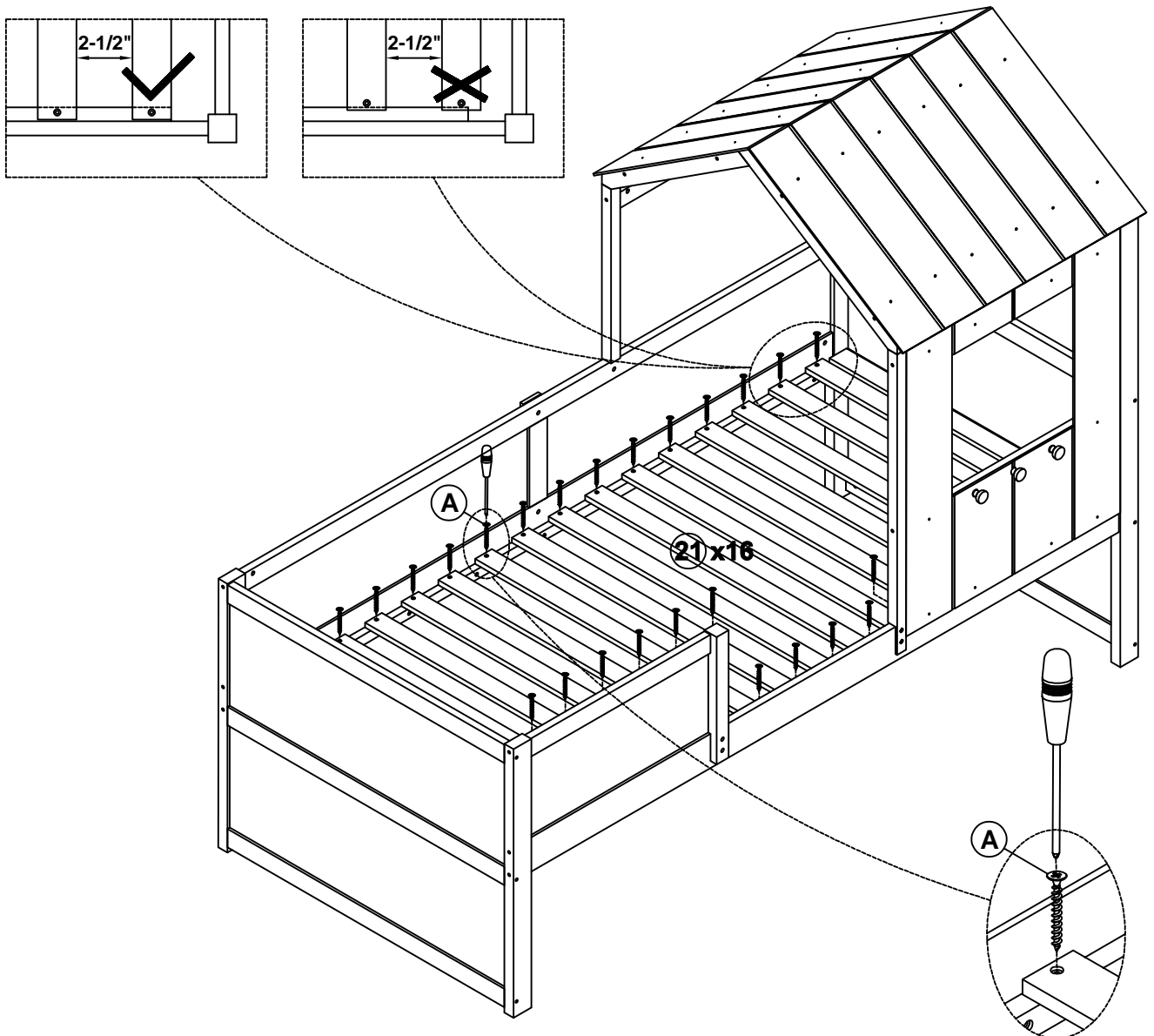

A Ø4x30



32PCS

Schritt 15

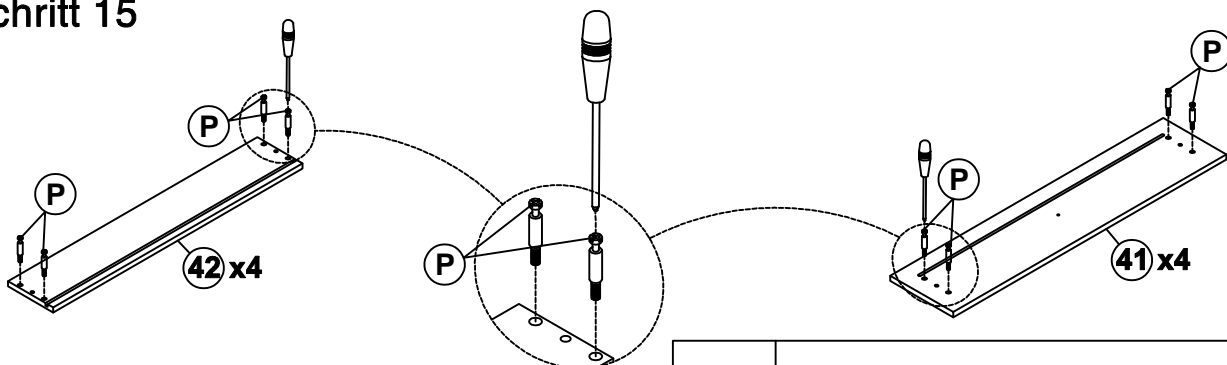

P

Ø6.5x35

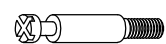



32PCS

MONTAGEANLEITUNGEN

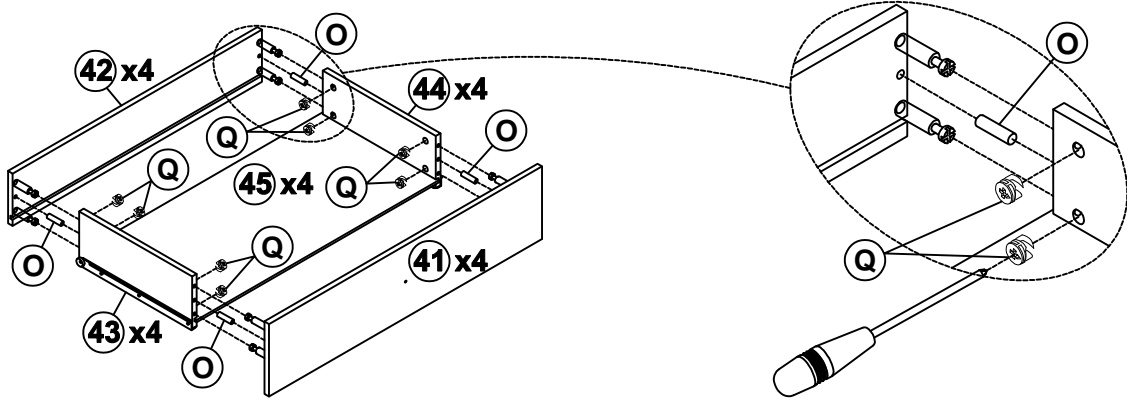

Schritt 16



Q	Ø12x10		32PCS	O	Ø8x30		16PCS
----------	--------	---	--------------	----------	-------	---	--------------

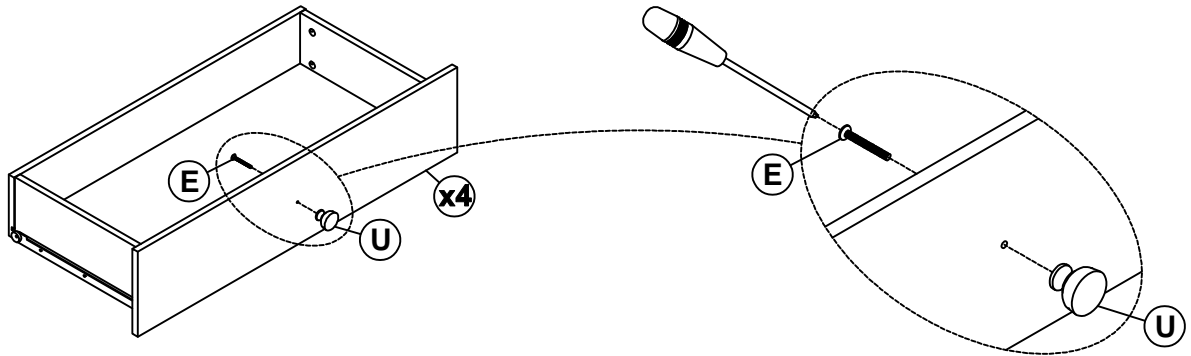

Schritt 17

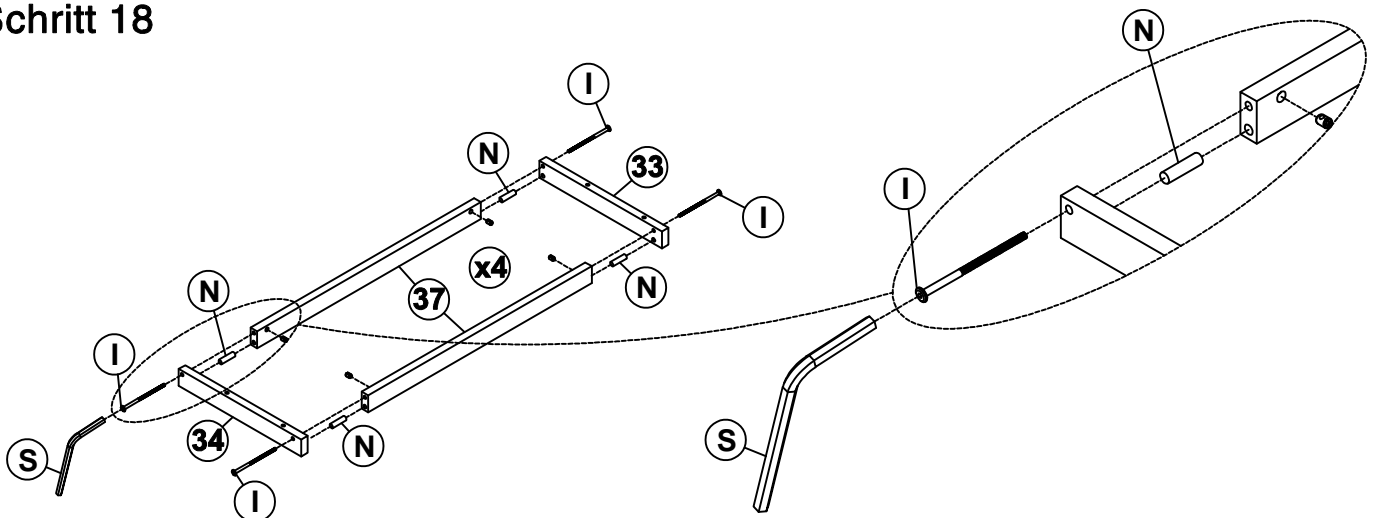

E	Ø4x25		4PCS	U	Ø28x27 (W)		4PCS
----------	-------	---	-------------	----------	------------	---	-------------

Schritt 18





N	Ø10x40		16PCS
I	1/4x60		16PCS
S	4x58		1PC

MONTAGEANLEITUNGEN

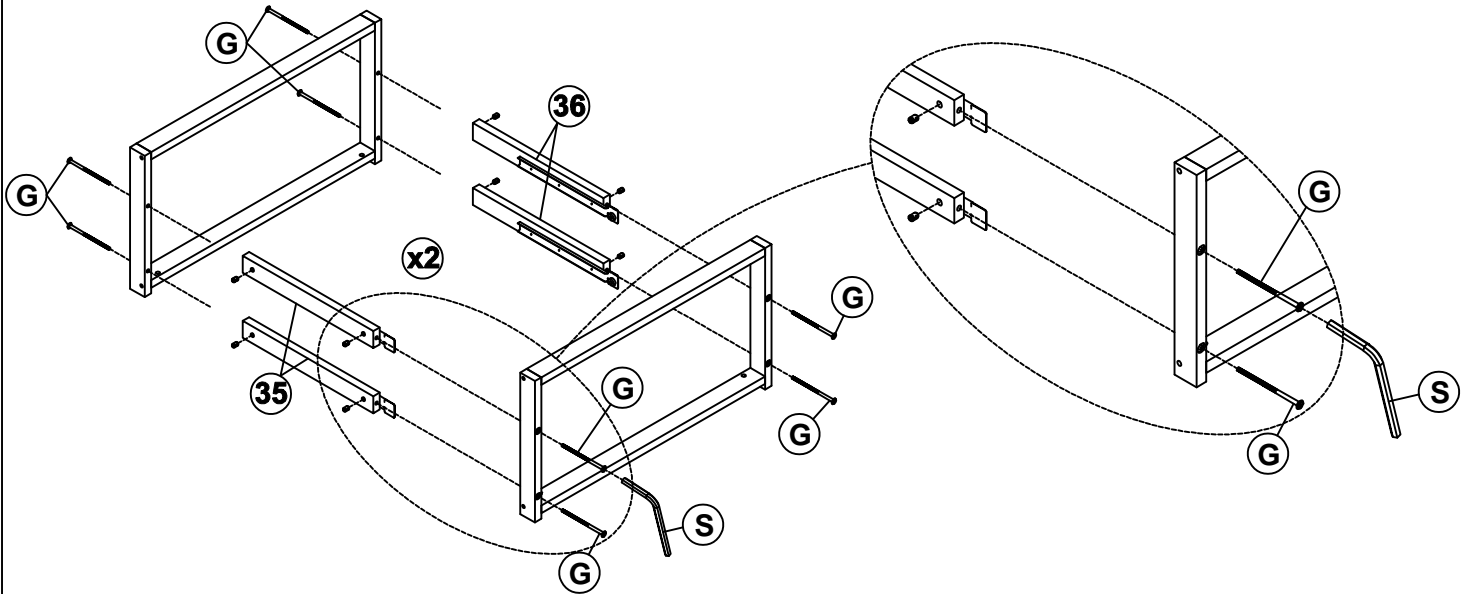
Schritt 19



G	1/4x90		16PCS	S	4x58		1PC
----------	--------	---	-------	----------	------	---	-----

Schritt 20

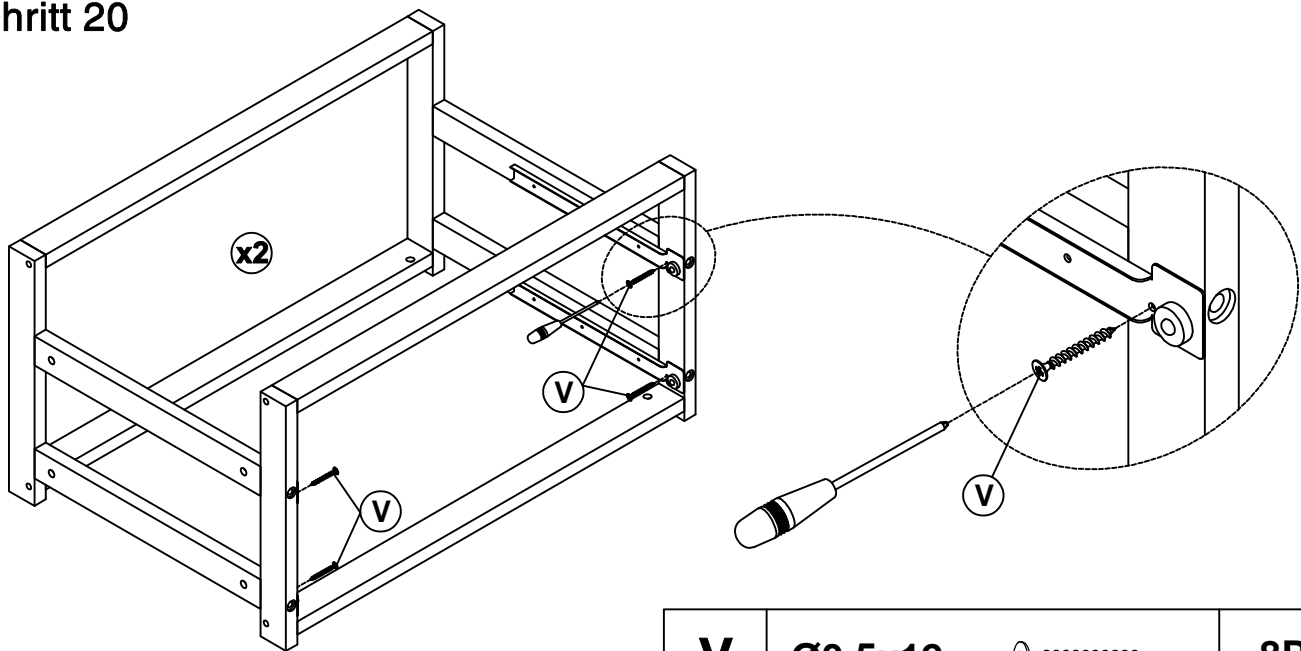

V	Ø3.5x12		8PCS
----------	---------	---	------

Schritt 21

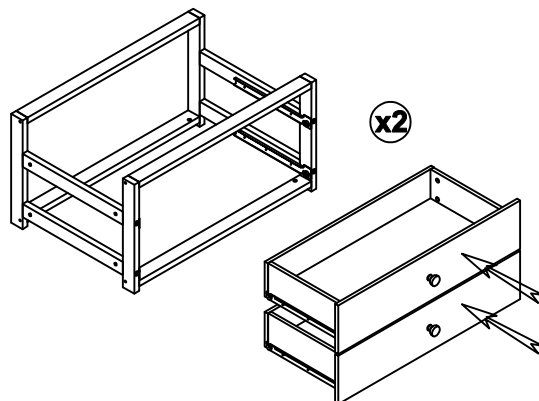

MONTAGEANLEITUNGEN

Schritt 22

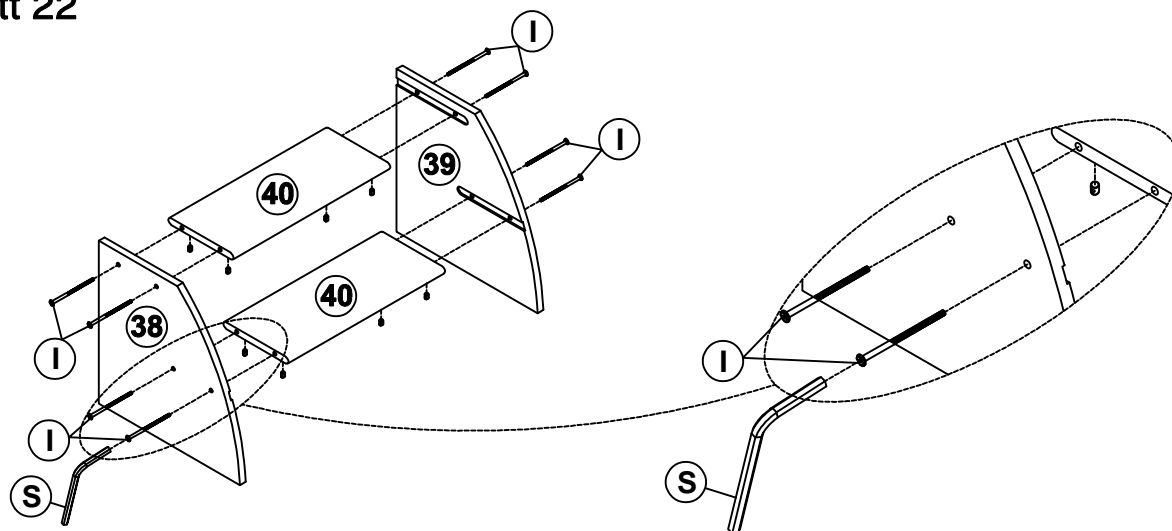
**I****1/4x60****8PCS****S****4x58****1PC**

Schritt 23

