

(D) Montageanleitung

(GB) Assembly instructions

(CZ) Montážní návod

(SK) Návod na montáž

(FR) Notice de montage

(IT) Istruzioni di montaggio

(HU) Szerelési útmutató

(RU) Instrucțiuni de montaj

(NL) Handleiding voor de montage

(PL) Instrukcja montażu

(TR) Montaj talimatı

(RU) Инструкция по монтажу



"HILTON"





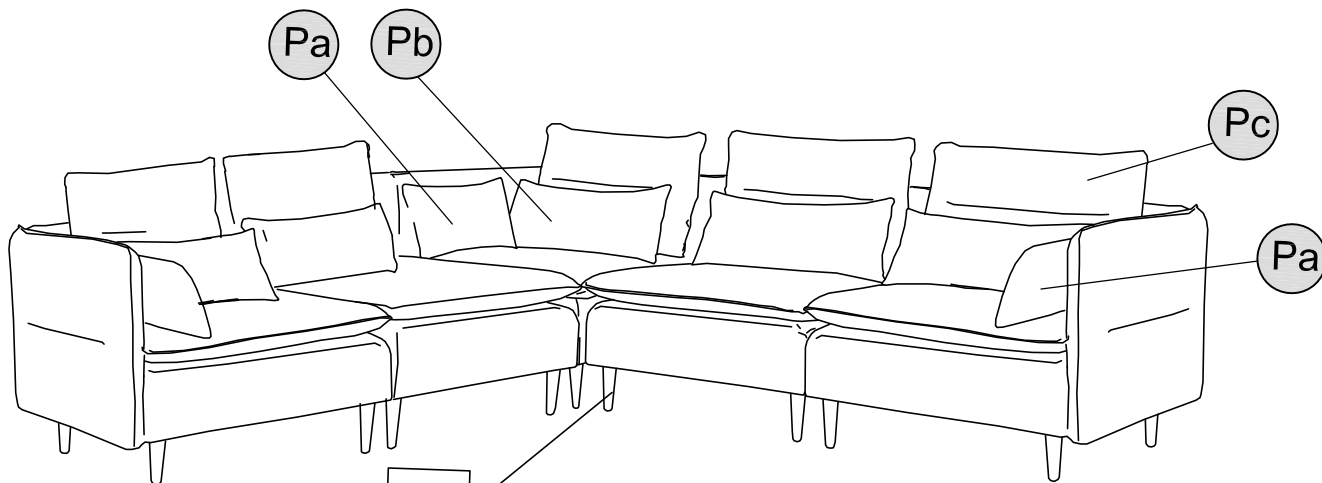

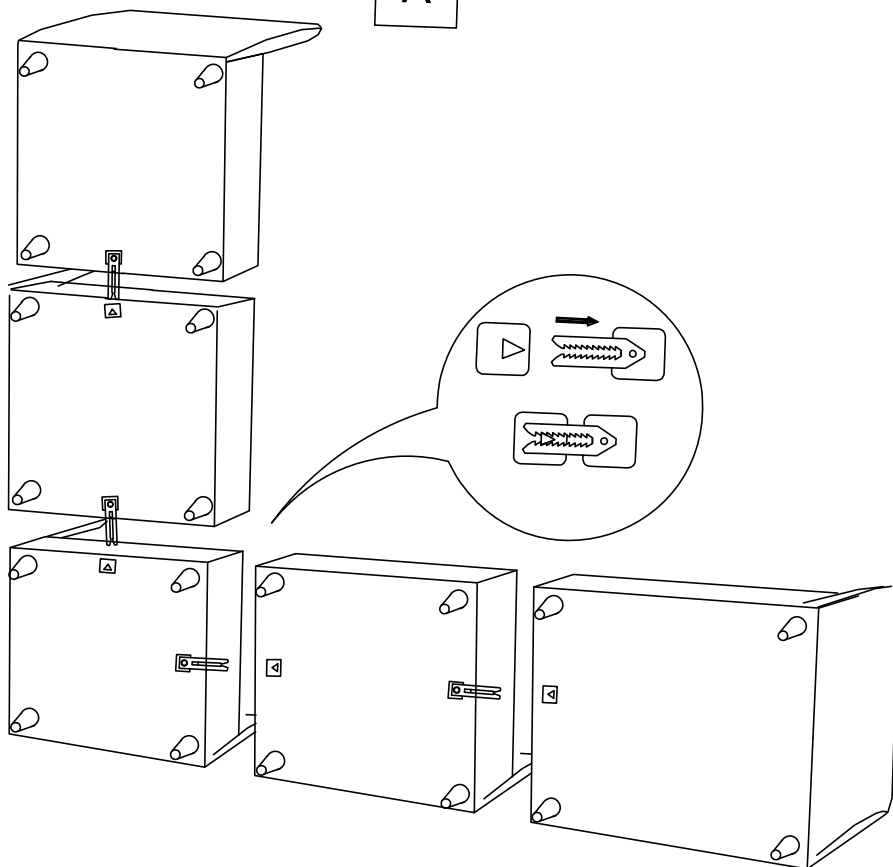

Pa Pb Pc



A



					
A	B	C	Pa	Pb	Pc
x20	x20	x20	x3	x4	x4

Name * Nom * Nome * Naaz * Nazwa * Jméno
 Názov * Név * Denumire * Isim * Название

"HILTON"

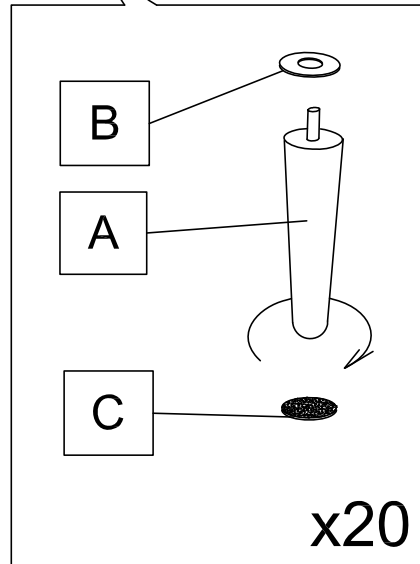
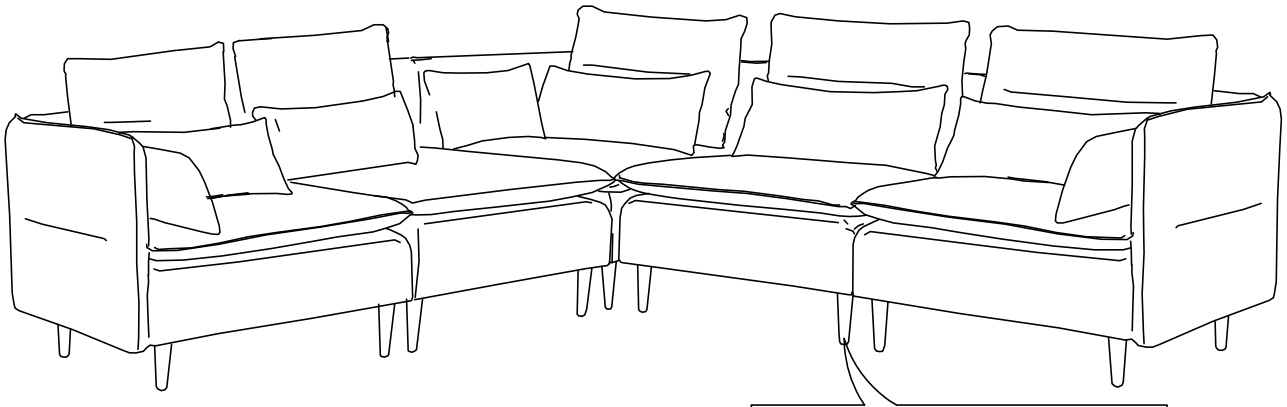
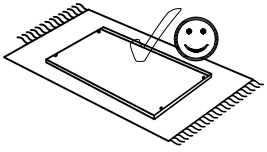
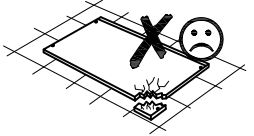
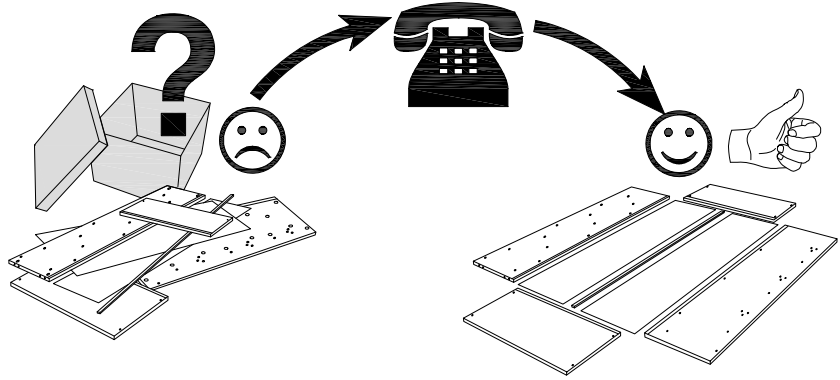
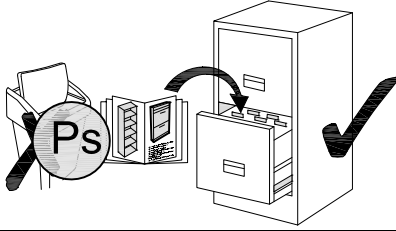

A	B	C
X....	X....	X....