

» Pedro I «

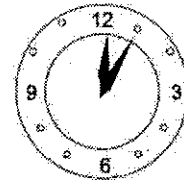

5'

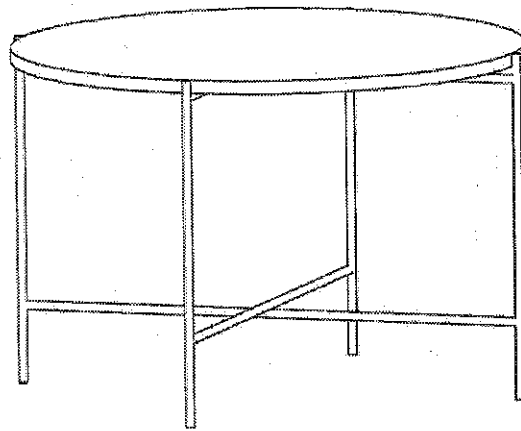
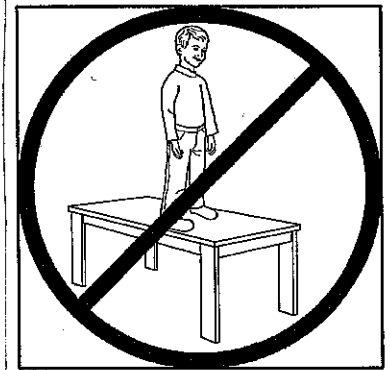

- | | |
|---|-------------------------------------|
| (D) Montageanleitung | (GB) Assembly instructions |
| (FR) Notice de montage | (IT) Istruzioni di montaggio |
| (NL) Handleiding voor de montage | (PL) Instrukcja montażu |
| (CZ) Montážní návod | (SK) Návod na montáž |
| (HU) Szerelési útmutató | (RO) Instrucțiuni de montaj |
| (TR) Montaj talimatı | (RU) Инструкция по монтажу |

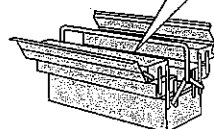

X

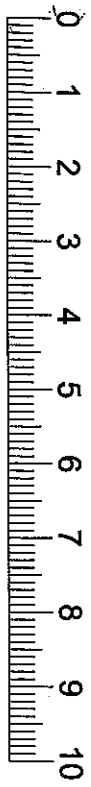

Service · Assistenza · Dienstverlening · Serwis Servis · Szerviz · Сервисная служба	
Name · Nom · Nome · Naam Nazwa · Jméno · Názov · Név Denumire · Ísm · Название	
Nr. · No. · N° · Номер · Č. · Sz	-
Tur · Type · Tip · Típus · Tipo Тип	-

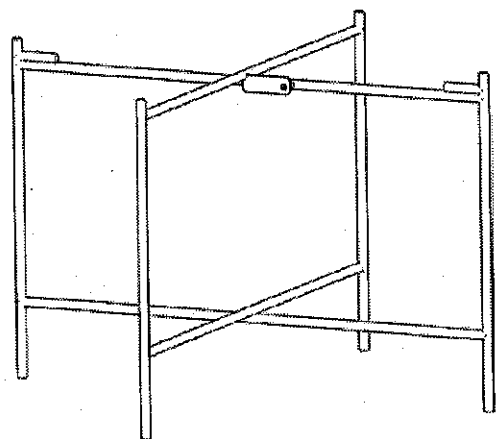

① 1x

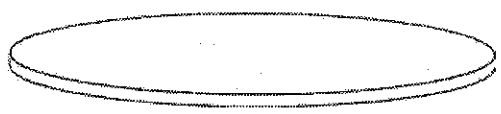

② 1x

