

Kinderrutschenset

BENUTZERHANDBUCH

PP311256

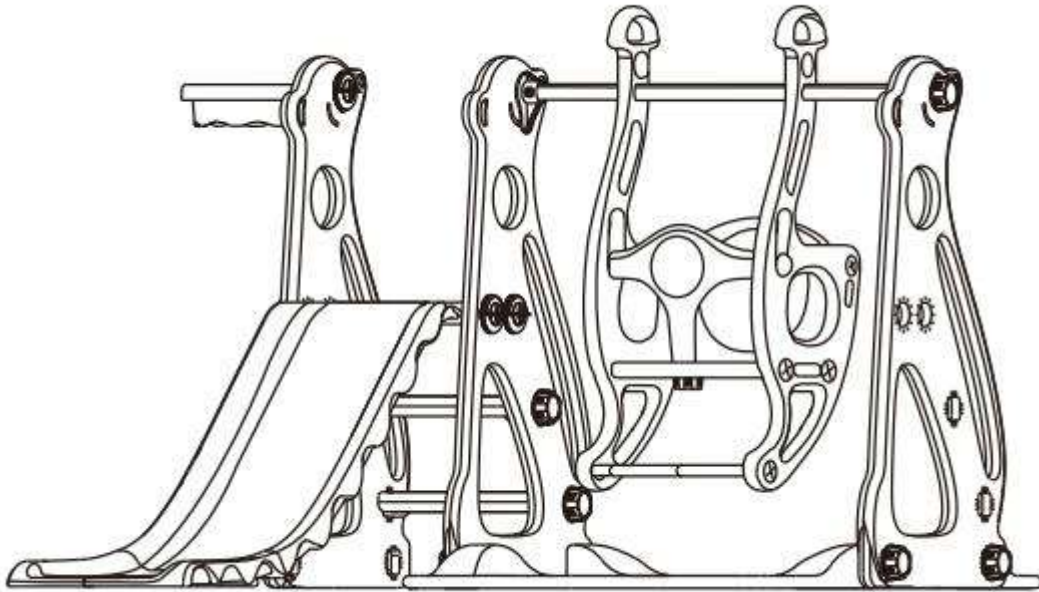

TESTSTANDARD: EN71

ART.-NR: FE-HT-BJX

LESEN SIE DIESE ANLEITUNG UND BEWAHREN SIE SIE
FÜR DEN ZUKÜNFTIGEN GEBRAUCH AUF

SICHERHEIT & WARNHINWEISE

MONTAGE DURCH ERWACHSENE ERFORDERLICH.

- Bewahren Sie diese Anleitung zum späteren Nachschlagen auf.
- Dieses Produkt ist nur für den Innen-, Familien- und Privatgebrauch bestimmt.
- Stellen Sie dieses Produkt auf ebenem Boden und mindestens 2 m von einem Laufstall, einem Gebäude, Ästen, Wäscheleinen oder Elektrokabeln entfernt auf. Dieses Produkt sollte nicht in der Nähe von Möbeln aufgestellt werden, die bei einem Sturz Verletzungen verursachen könnten.
- Stellen Sie sicher, dass der Installationsbereich belüftet ist.
- Benutzen Sie das Produkt nicht, wenn es beschädigt oder defekt ist. Wenn es beschädigt oder defekt ist, wenden Sie sich bitte an einen qualifizierten Techniker.
- Überprüfen Sie vor dem Gebrauch, ob alle Teile gut zusammengebaut und stabil sind. Defekte Teile müssen sofort ausgetauscht werden, da sie die Funktion und Sicherheit des Produkts beeinträchtigen können.
- Wenn die Temperaturen unter den Gefrierpunkt (0 °C/32 °F) fallen, wird die Verwendung dieses Produkts im Freien nicht empfohlen. Bei extremer Kälte verlieren Kunststoffmaterialien an Widerstandsfähigkeit und können bei Stößen spröde werden und Risse bekommen. Lagern Sie das Produkt an einem wärmeren, geschützten Ort.
- Von Feuer oder anderen Zündquellen fernhalten.
- Verpackungsmaterialien sind kein Spielzeug, halten Sie sie von Kindern fern.
- Weisen Sie Kinder in die ordnungsgemäße Verwendung dieses Produkts ein: nur nach ordnungsgemäßer Montage und Installation und nicht auf andere als die vorgesehene Weise.
- Ziehen Sie Kinder angemessen an: Erlauben Sie Kindern nicht, locker sitzende Kleidung wie Ponchos, Schals und Kleidungsstücke mit Kordelzug zu tragen. Es müssen stets gutsitzende Schuhe getragen werden.
- Vermeiden Sie es, Geräte direktem Sonnenlicht auszusetzen, da heiße Oberflächen schwere Verbrennungen verursachen können.
- Beaufsichtigen Sie stets einen Erwachsenen.

BITTE NICHT ZUM LADEN ZURÜCKGEBEN



Bitte geben Sie dieses Produkt nicht an den Händler zurück!!

Wir können Ihnen in jeder Hinsicht behilflich sein.

Wenn Sie feststellen, dass Sie Probleme haben, wenden Sie sich bitte an den Verkäufer



[DE]

Warnung: Dieses Produkt ist nicht für Kinder unter 12 Monaten geeignet.

Warnung: Aufgrund der Kleinteile sollten Kinder das Produkt nur unter Aufsicht von Erwachsenen verwenden, um die Gefahr des Verschluckens zu vermeiden. Verschlucken Sie nicht alle Produkte und Teile, einschließlich Kunststoffteile, Netze, Eisenteile und anderes Zubehör.

Warnung: Um die Sicherheit zu gewährleisten, befolgen Sie bitte die Anweisungen zur korrekten Installation und holen Sie sich bei Bedarf professionelle Hilfe.

Warnung: Stellen Sie Möbel nicht in der Nähe von Feuerquellen oder Gegenständen mit hoher Temperatur auf, um Brandgefahr zu vermeiden. Nur für den Innenbereich.

[EN]

Warning: Not suitable for children under 12 months.

Warning: Due to the small parts of the product, children should only use it under adult supervision to avoid a swallowing hazard. Do not swallow all products and parts, including plastic parts, nets, iron parts, and other accessories.

Warning: To ensure safety, please follow the instructions for correct installation and seek professional assistance if necessary.

Warning: Do not place furniture close to fire sources or high-temperature objects to avoid the risk of fire. For indoor use only.

[FR]

Avertissement : Ce produit ne convient pas aux enfants de moins de 12 mois.

Avertissement : En raison des petites pièces du produit, les enfants ne doivent l'utiliser que sous la surveillance d'un adulte afin d'éviter tout risque d'ingestion. N'avaliez pas tous les produits et pièces, y compris les pièces en plastique, les filets, les pièces en fer et autres accessoires.

Avertissement : Pour garantir la sécurité, veuillez suivre les instructions pour une installation correcte et demander l'aide d'un professionnel si nécessaire.

Avertissement : Ne placez pas les meubles à proximité de sources d'incendie ou d'objets à haute température pour éviter tout risque d'incendie. Pour une utilisation en intérieur uniquement.

[IT]

Attenzione: Questo prodotto non è adatto ai bambini di età inferiore a 12 mesi.

Attenzione: A causa delle piccole parti del prodotto, i bambini devono utilizzarlo solo sotto la supervisione di un adulto per evitare il rischio di soffocamento. A causa delle piccole parti del prodotto, i bambini devono usarlo solo sotto la supervisione di un adulto per evitare il rischio di ingestione. Non ingerire tutti i prodotti e le parti, comprese le parti in plastica, le reti, le parti in ferro e altri accessori.

Attenzione: Per garantire la sicurezza, seguire le istruzioni per una corretta installazione e, se necessario, richiedere assistenza professionale.

Attenzione: Non posizionare i mobili vicino a fonti di fuoco o oggetti ad alta temperatura per evitare il rischio di incendio. Solo per uso interno.

[ES]

Advertencia: Este producto no es adecuado para niños menores de 12 meses.

Advertencia: Debido a las pequeñas piezas del producto, los niños sólo deben utilizarlo bajo la supervisión de un adulto para evitar el riesgo de asfixia. No trague todos los productos y piezas, incluidas las piezas de plástico, las redes, las piezas de hierro y otros accesorios.

Advertencia: Para garantizar la seguridad, siga las instrucciones para una instalación correcta y busque asistencia profesional si es necesario.

Advertencia: No coloque muebles cerca de fuentes de fuego u objetos de alta temperatura para evitar el riesgo de incendio. Solo para uso en interiores.



Importeur	Decobus Handel GmbH		
Adresse	Innungsstraße 9, 21244 Buchholz, Deutschland		
URL	https://www.decobusgroup.de		
Hersteller	Yongjia Feiqi Toy Co.,Ltd		
Adresse	Bali Industrial Zone,QiaoXiaTown,WenzhouCity,Zhejiang		
Email/URL	exp08@feelkids.com		
<table border="1"><tr><td>EC</td><td>REP</td></tr></table>	EC	REP	Decobus Handel GmbH Innungsstraße 9, 21244 Buchholz, Deutschland https://www.decobusgroup.de
EC	REP		



Declaration OF COMPLIANCE

Report No. CTT2211031480EN **Issued Date:** Feb.06, 2023

This certificate of conformity is based on an evaluation of a sample of the following mentioned product, and technical report and documentation are at the license holder's disposal. This is to certify that the tested sample is in conformity with all related provisions as follows: 1. EN71 under Toys Directive 2009/48/EC; It is possible to use CE marking to demonstrate the compliance with this toys Directive.

Sample Name: Slide
Age Group: 12M+
Applicant: YONGJIA FEIQI TOY CO., LTD
Address: BALI, QIAOXIA TOWN, YONGJIA COUNTY, WENZHOU CITY, ZHEJIANG PROVINCE.CHINA

Model No.: FE-HT-XXX、FE-HT-XLB、L-HT22、FE-HT-BJX、FE-HT-XKL、FE-HT-KAL、FE-HT-XG0、L-DX001R、FE-HT-KAG、FE-HT-MYY、FQ-HT-QDPC、FQ-HT-QDPP、L-XS01、FE-HT-DG1、L-CJL001、L-KL001、L-NLL001、L-NLL002、FQ-H001、FQ-H003、FQ-CL02、L-HT01R、L-DC01

Measurement Items: EN71-1 Mechanical & Physical Test/EN71-2 Flammability Test/EN71-3 Migration of certain elements/EN 71-8 Activity toys for domestic use

The certificate applies to the tested sample above mentioned only and shall not imply an assessment of the whole production. It is only valid in connection with the test report (Report No. CTT2211031480EN)



Signed for and on Behalf of CTT

Frank



Frank / Lab manager
Consumer Testing Technology Co., Ltd.

STÜCKLISTE 1

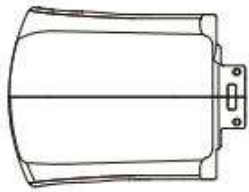

Bereich erweitern *1

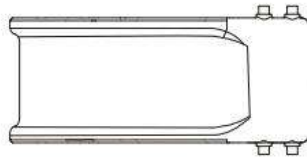

Haupttrutsche *1



Schwingarmlehne *1



Sitz*1



Dekoration*1



Basketballkorb*1



Basketball*1

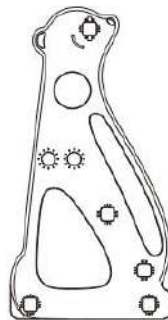

Seitenleiste*3



Eisenrohr*1

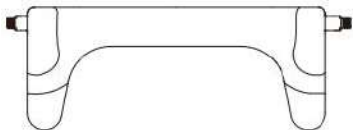

Schwingboden*2

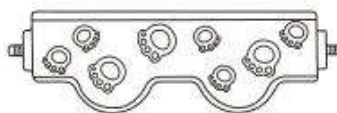

Schwingpaddel*1



Stufen*2



Schwenkbare Seitenteile*2



Mutter A*2



Mutter B*8

STÜCKLISTE 2



Mutter C*1



Mutter D*4

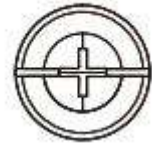

Mutter G*5



Mutter F*10



Mutter G*2



Mutter G*2



Wasserstopfen*2



Werkzeug*1

MONTIEREN

1. Verbinden Sie den Verlängerungsbereich mit dem Schlitten und Ziehen Sie ihn mit der Mutter A*2 von der Rückseite fest.

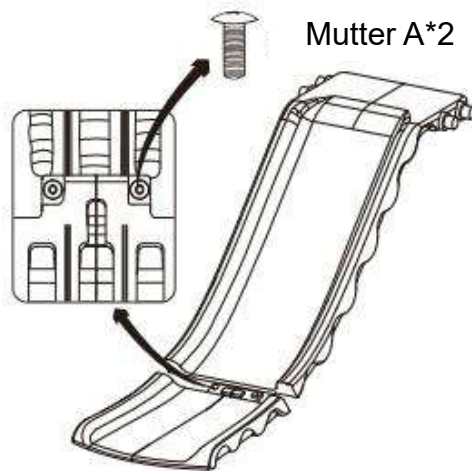

2. Verbinden Sie den in Schritt 1 installierten Schlitten mit der Seitenwand mit Mutter E.

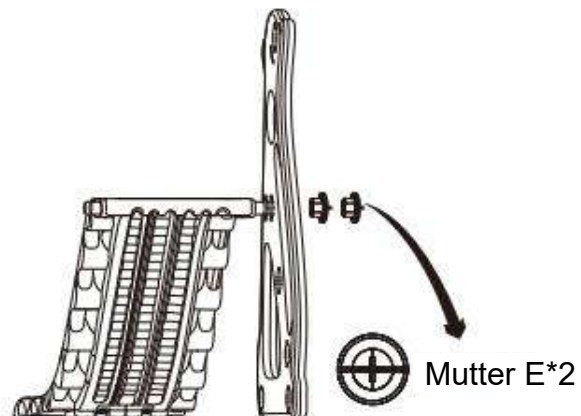

3. Setzen Sie die Treppe in die Seitenwand ein und ziehen Sie sie mit der Mutter F fest.

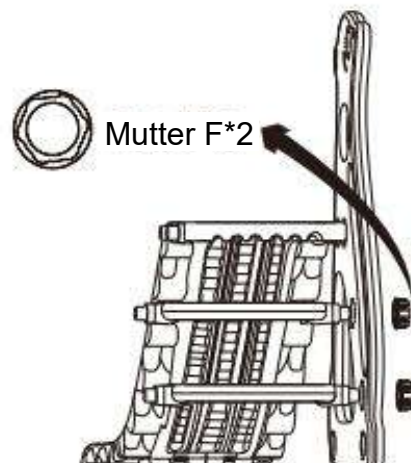

4. Verbinden Sie ein weiteres Seitenteil mit Mutter E und F.

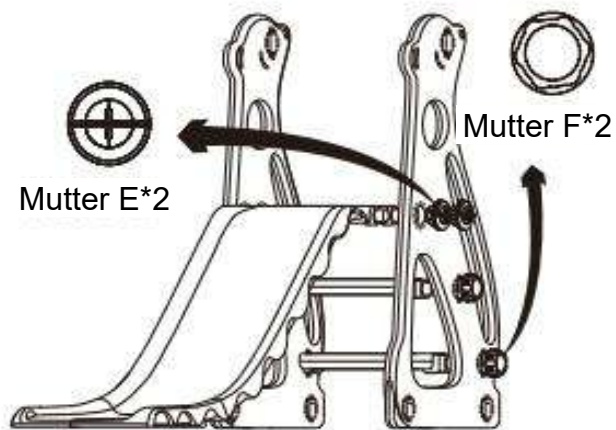

5. Setzen Sie den Gleitboden in die Seitenwand ein und ziehen Sie ihn mit der Mutter F fest.

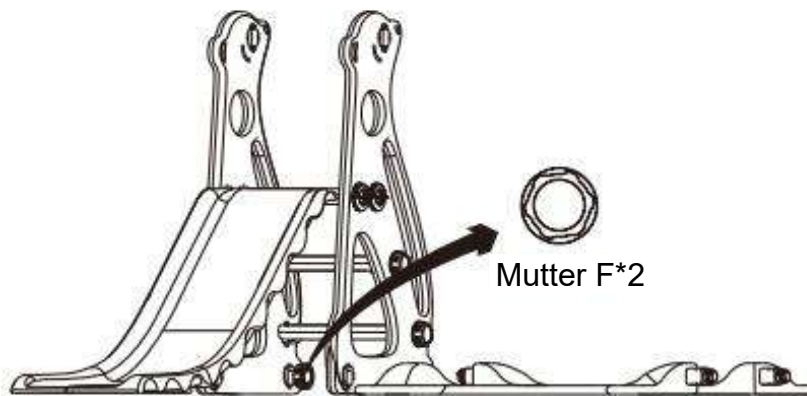

6. Befestigen Sie das Eisenrohr mit Mutter G an den Seitenwänden und ziehen Sie es mit Mutter H und Mutter F fest.

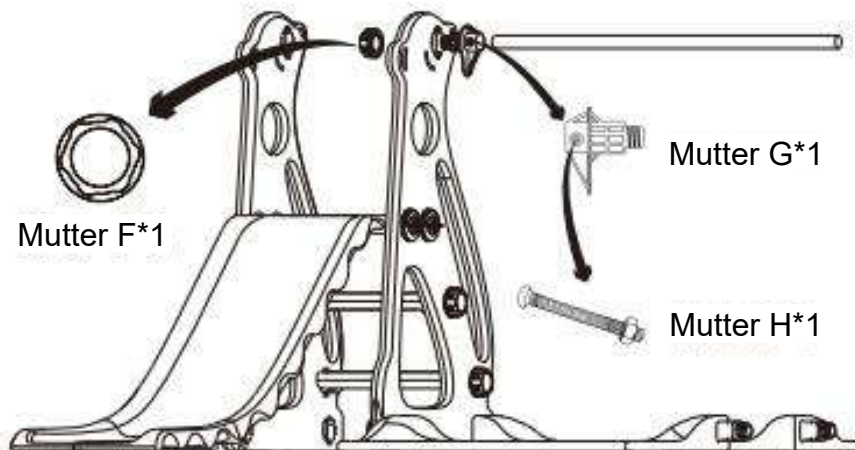

7. Montieren Sie den Sitz und ziehen Sie ihn mit Mutter C und Mutter B fest.

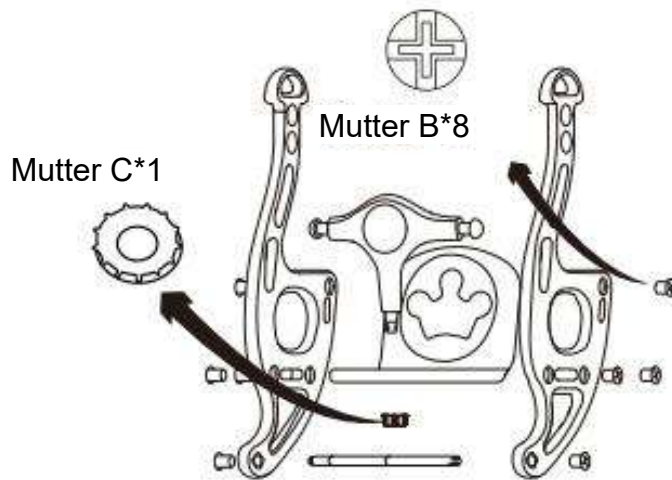

8. Setzen Sie die Schaukel in das Eisenrohr ein und ziehen Sie sie mit Mutter D fest.

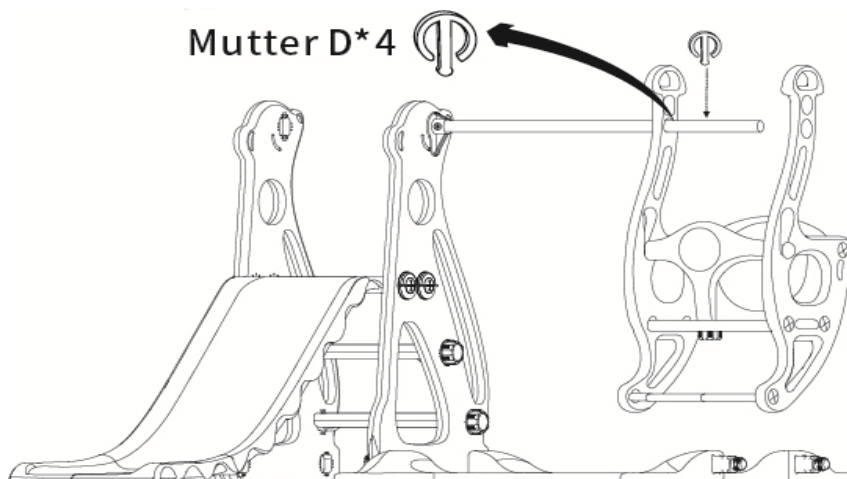

9. Verwenden Sie Mutter H, um Mutter G festzuziehen.

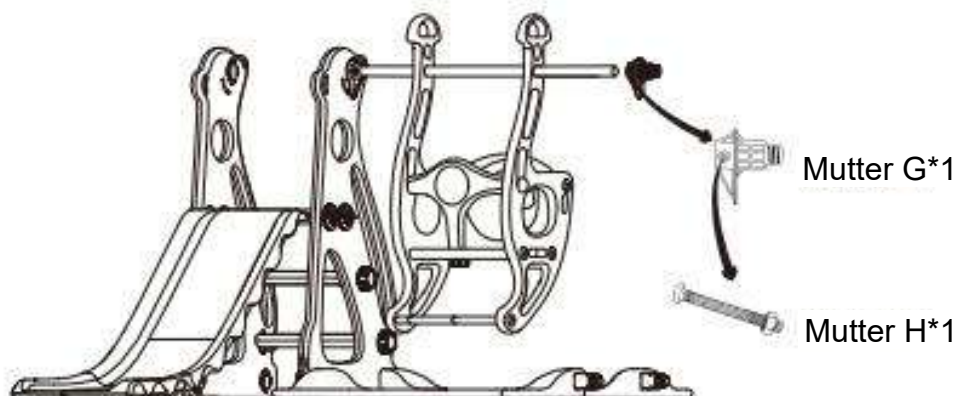

10. Verbinden Sie das Eisenrohr mit einer anderen Seitenwand und ziehen Sie es mit der Mutter F fest.

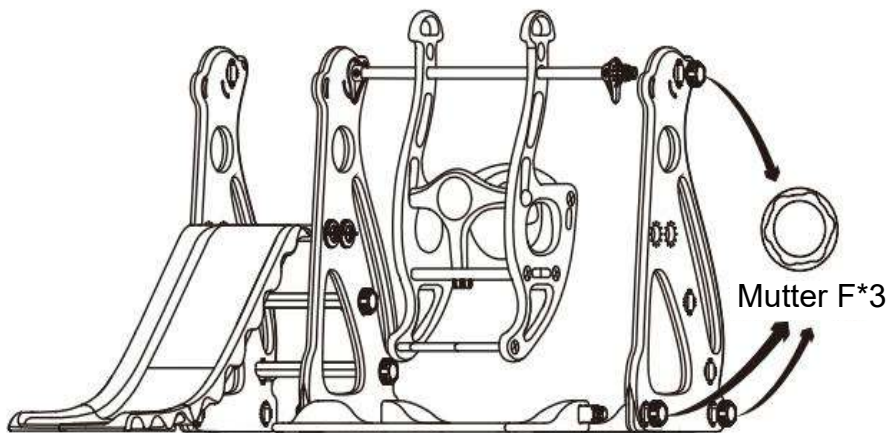

11. Verwenden Sie die Mutter E, um den Basketballkorb festzuziehen.

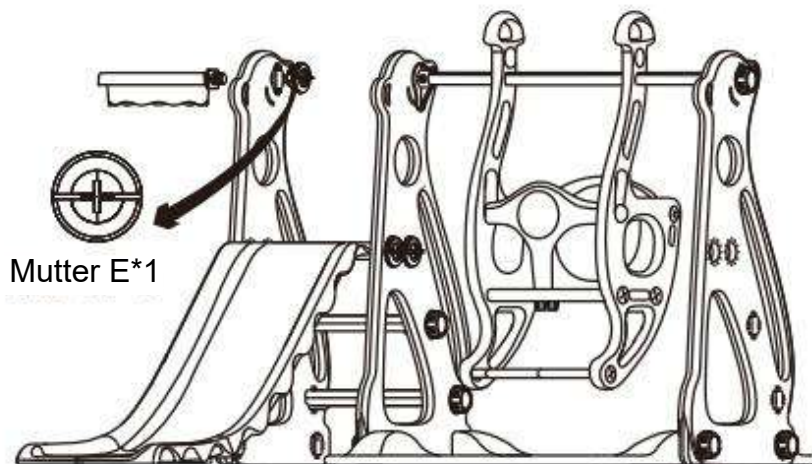

12. Fügen Sie Dekorationen hinzu. Das Produkt ist komplett montiert.

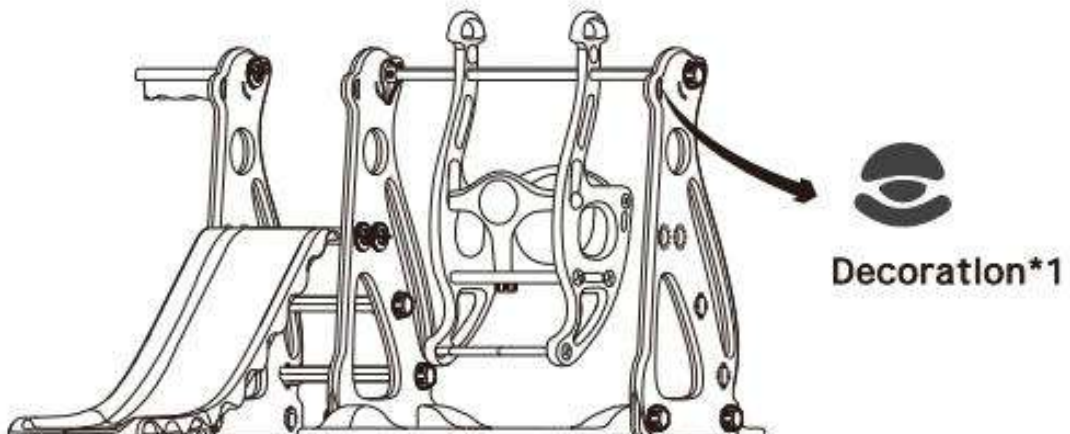

Children Slide Set

USER MANUAL
PP311256

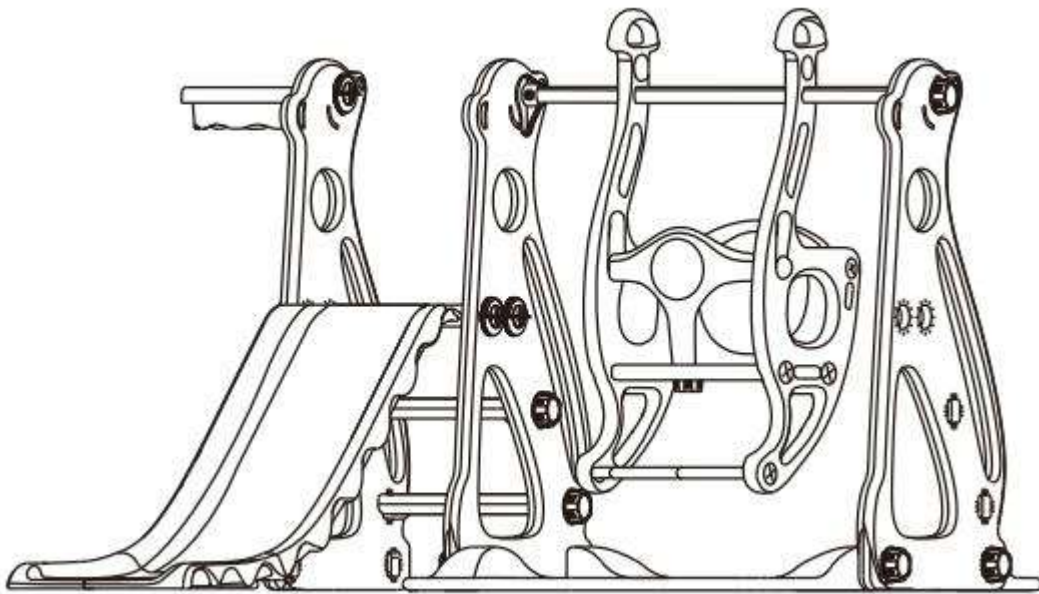

Test Request: EN71,

ITEM NO: FE-HT-BJX

READ AND SAVE THIS INSTRUCTION FOR FUTURE USE

SAFETY & WARNINGS

ADULT ASSEMBLY REQUIRED.

- Keep these instructions for future reference.
- This product is intended for indoor, family, domestic use only.
- Place this product on level ground and at least 2 m away from a playpen, building, overhead branches, laundry lines or electrical wires. This product should be placed away from furniture that could cause injury if a fall occurs.
- Ensure the installation area is ventilated.
- Do not use the product if it is damaged or defective. If it is damaged or defective, please contact a qualified technician.
- Check that all parts are assembled well and are stable before use. Defective parts must be changed immediately as they can impair the function and the safety of the product.
- When temperatures fall below freezing (0°C/32°F), outdoor use of this product is not recommended. In extreme cold, plastic materials lose resilience and may become brittle and crack with impact. Store product in a warmer, protected place.
- Keep away from fire or any source of ignition.
- Packing materials are not toys, keep them away from children.
- Instruct children on proper use of this product: only after properly assembled and installed, and not in a manner other than intended.
- Dress children appropriately: do not allow children to wear loose-fitting clothing including ponchos, scarves, and garments with drawstrings. Well-fitting shoes must be always worn.
- Avoid placing equipment in direct sunlight as hot surfaces could cause serious burns.
- Always provide adult supervision.

PLEASE DO NOT RETURN TO STORE



Please do not return this product to the retailer!!

We are able to assist you in ANY way.

If you find that you have any trouble with assembly or missing or damaged parts, please contact the seller



[DE]

Warnung: Dieses Produkt ist nicht für Kinder unter 12 Monaten geeignet.

Warnung: Aufgrund der Kleinteile sollten Kinder das Produkt nur unter Aufsicht von Erwachsenen verwenden, um die Gefahr des Verschluckens zu vermeiden. Verschlucken Sie nicht alle Produkte und Teile, einschließlich Kunststoffteile, Netze, Eisenteile und anderes Zubehör.

Warnung: Um die Sicherheit zu gewährleisten, befolgen Sie bitte die Anweisungen zur korrekten Installation und holen Sie sich bei Bedarf professionelle Hilfe.

Warnung: Stellen Sie Möbel nicht in der Nähe von Feuerquellen oder Gegenständen mit hoher Temperatur auf, um Brandgefahr zu vermeiden. Nur für den Innenbereich.

[EN]

Warning: Not suitable for children under 12 months.

Warning: Due to the small parts of the product, children should only use it under adult supervision to avoid a swallowing hazard. Do not swallow all products and parts, including plastic parts, nets, iron parts, and other accessories.

Warning: To ensure safety, please follow the instructions for correct installation and seek professional assistance if necessary.

Warning: Do not place furniture close to fire sources or high-temperature objects to avoid the risk of fire. For indoor use only.

[FR]

Avertissement : Ce produit ne convient pas aux enfants de moins de 12 mois.

Avertissement : En raison des petites pièces du produit, les enfants ne doivent l'utiliser que sous la surveillance d'un adulte afin d'éviter tout risque d'ingestion. N'avaliez pas tous les produits et pièces, y compris les pièces en plastique, les filets, les pièces en fer et autres accessoires.

Avertissement : Pour garantir la sécurité, veuillez suivre les instructions pour une installation correcte et demander l'aide d'un professionnel si nécessaire.

Avertissement : Ne placez pas les meubles à proximité de sources d'incendie ou d'objets à haute température pour éviter tout risque d'incendie. Pour une utilisation en intérieur uniquement.

[IT]

Attenzione: Questo prodotto non è adatto ai bambini di età inferiore a 12 mesi.

Attenzione: A causa delle piccole parti del prodotto, i bambini devono utilizzarlo solo sotto la supervisione di un adulto per evitare il rischio di soffocamento. A causa delle piccole parti del prodotto, i bambini devono usarlo solo sotto la supervisione di un adulto per evitare il rischio di ingestione. Non ingerire tutti i prodotti e le parti, comprese le parti in plastica, le reti, le parti in ferro e altri accessori.

Attenzione: Per garantire la sicurezza, seguire le istruzioni per una corretta installazione e, se necessario, richiedere assistenza professionale.

Attenzione: Non posizionare i mobili vicino a fonti di fuoco o oggetti ad alta temperatura per evitare il rischio di incendio. Solo per uso interno.

[ES]

Advertencia: Este producto no es adecuado para niños menores de 12 meses.

Advertencia: Debido a las pequeñas piezas del producto, los niños sólo deben utilizarlo bajo la supervisión de un adulto para evitar el riesgo de asfixia. No trague todos los productos y piezas, incluidas las piezas de plástico, las redes, las piezas de hierro y otros accesorios.

Advertencia: Para garantizar la seguridad, siga las instrucciones para una instalación correcta y busque asistencia profesional si es necesario.

Advertencia: No coloque muebles cerca de fuentes de fuego u objetos de alta temperatura para evitar el riesgo de incendio. Solo para uso en interiores.



Importeur	Decobus Handel GmbH		
Adresse	Innungsstraße 9, 21244 Buchholz, Deutschland		
URL	https://www.decobusgroup.de		
Hersteller	Yongjia Feiqi Toy Co.,Ltd		
Adresse	Bali Industrial Zone,QiaoXiaTown,WenzhouCity,Zhejiang		
Email/URL	exp08@feelkids.com		
<table border="1"><tr><td>EC</td><td>REP</td></tr></table>	EC	REP	Decobus Handel GmbH Innungsstraße 9, 21244 Buchholz, Deutschland https://www.decobusgroup.de
EC	REP		



Declaration OF COMPLIANCE

Report No. CTT2211031480EN **Issued Date:** Feb.06, 2023

This certificate of conformity is based on an evaluation of a sample of the following mentioned product, and technical report and documentation are at the license holder's disposal. This is to certify that the tested sample is in conformity with all related provisions as follows: 1. EN71 under Toys Directive 2009/48/EC; It is possible to use CE marking to demonstrate the compliance with this toys Directive.

Sample Name: Slide
Age Group: 12M+
Applicant: YONGJIA FEIQI TOY CO., LTD
Address: BALI, QIAOXIA TOWN, YONGJIA COUNTY, WENZHOU CITY, ZHEJIANG PROVINCE.CHINA

Model No.: FE-HT-XXX、FE-HT-XLB、L-HT22、FE-HT-BJX、FE-HT-XKL、FE-HT-KAL、FE-HT-XG0、L-DX001R、FE-HT-KAG、FE-HT-MYY、FQ-HT-QDPC、FQ-HT-QDPP、L-XS01、FE-HT-DG1、L-CJL001、L-KL001、L-NLL001、L-NLL002、FQ-H001、FQ-H003、FQ-CL02、L-HT01R、L-DC01

Measurement Items: EN71-1 Mechanical & Physical Test/EN71-2 Flammability Test/EN71-3 Migration of certain elements/EN 71-8 Activity toys for domestic use

The certificate applies to the tested sample above mentioned only and shall not imply an assessment of the whole production. It is only valid in connection with the test report (Report No. CTT2211031480EN)



Signed for and on Behalf of CTT

Frank



Frank / Lab manager
Consumer Testing Technology Co., Ltd.

PART LIST 1

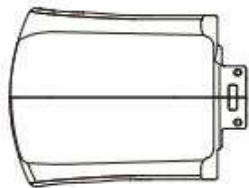

Extend area*1

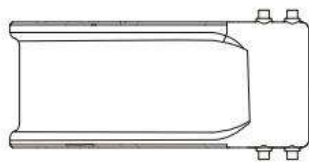

Main slide*1



Swing armrest*1



Seat*1



Decoration*1



Basketball hoop*1



Basketball *1

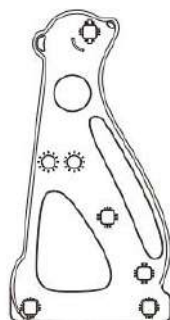

Side panel*3



Iron tube*1

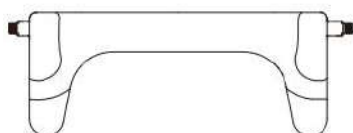

Swing bottom*2

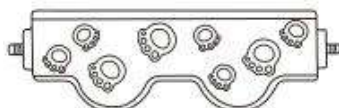

Swing paddle *1

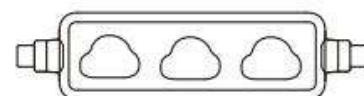

Stair*2



Swing side panel*2



Nut A*2



Nut B*8

PART LIST 2



Nut C*1



Nut D*4

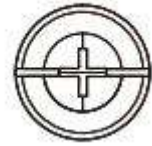

Nut E*5



Nut F*10



Nut G*2



Nut H*2



Water plug*2



Tool*1

ASSEMBLY

1. Connect the extend area with slide and tighten with Nut A*2 from the back.



2. Connect the slide installed in step 1 with side panel with Nut E.

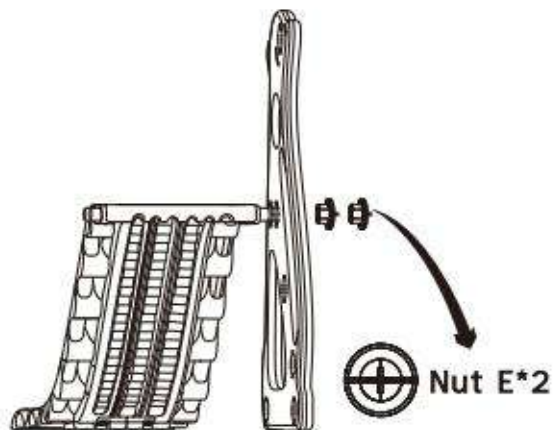

3. Insert the stair into the side panel and tighten with Nut F.

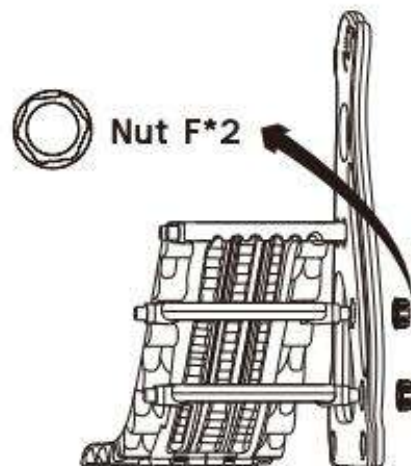

4. Connect another side panel with Nut E and F.

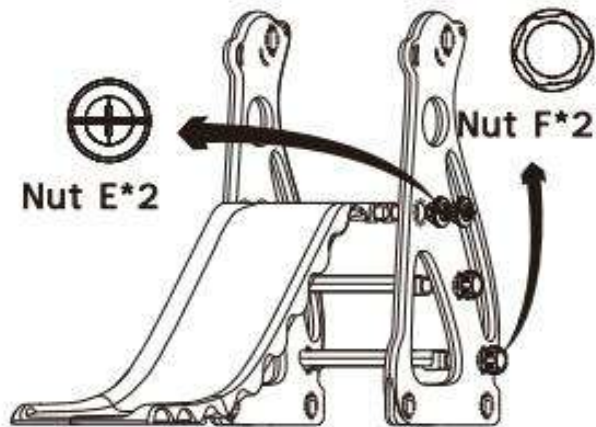

5. Insert the slide bottom into side panel and tighten with Nut F.

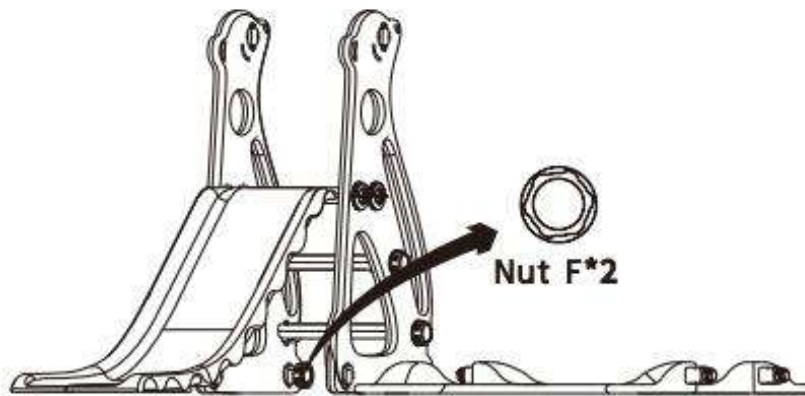

6. Secure the iron tube to the side panels with Nut G, and tighten with Nut H and Nut F.

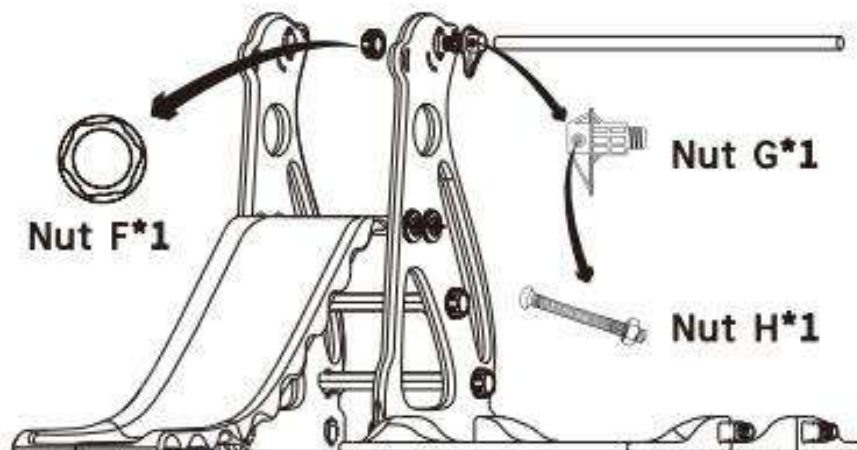

7. Assemble the seat, tighten with Nut C and Nut B.

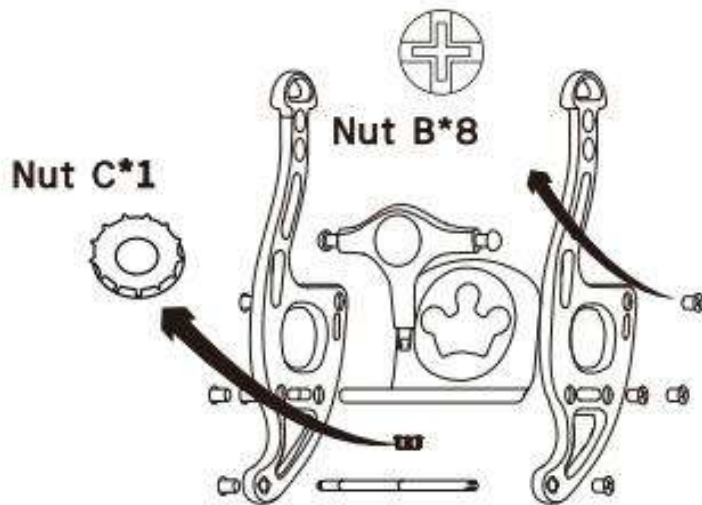

8. Insert the swing into iron tube, and tighten with Nut D.

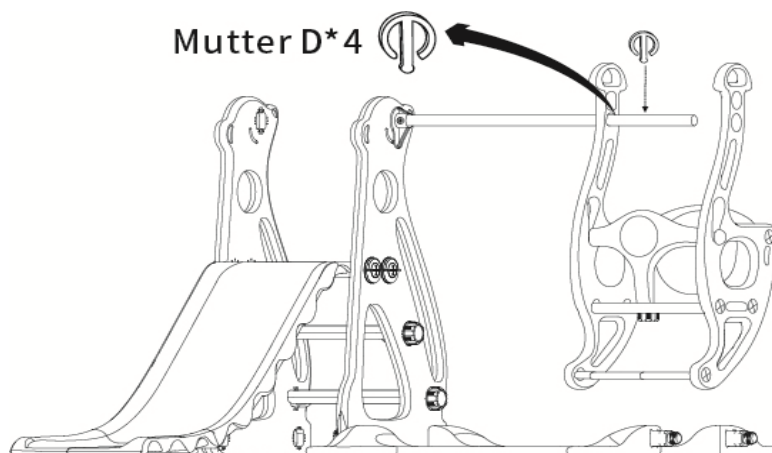

9. Use Nut H to tighten Nut G.

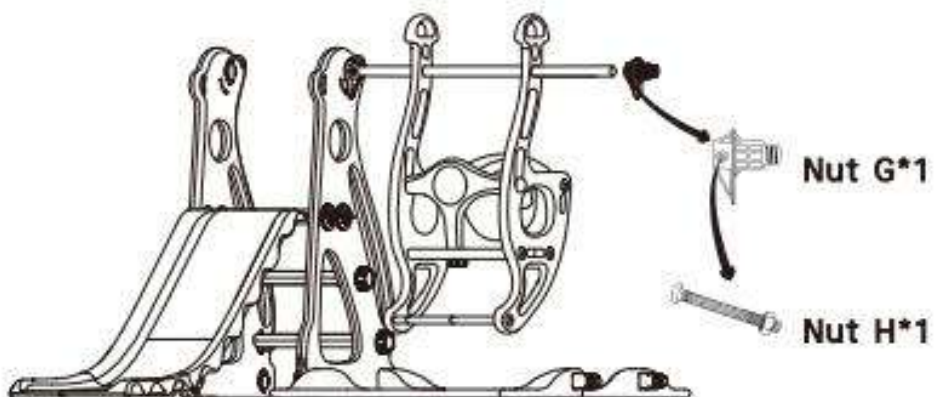

10. Connect the iron tube with another side panel and tighten with Nut F.

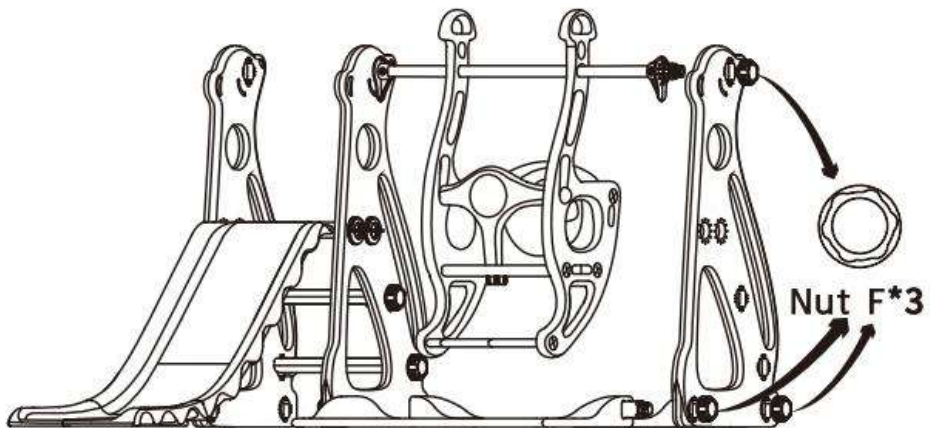

11. Use Nut E to tighten basketball hoop.

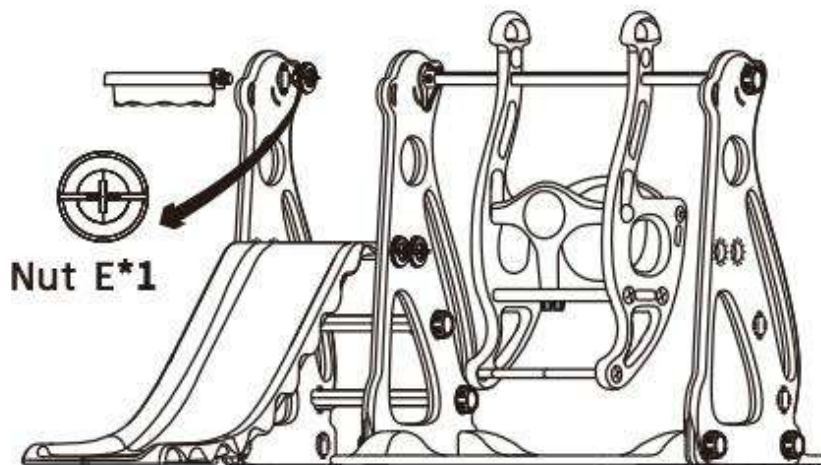

12. Add decorations, The product is assembled completely.

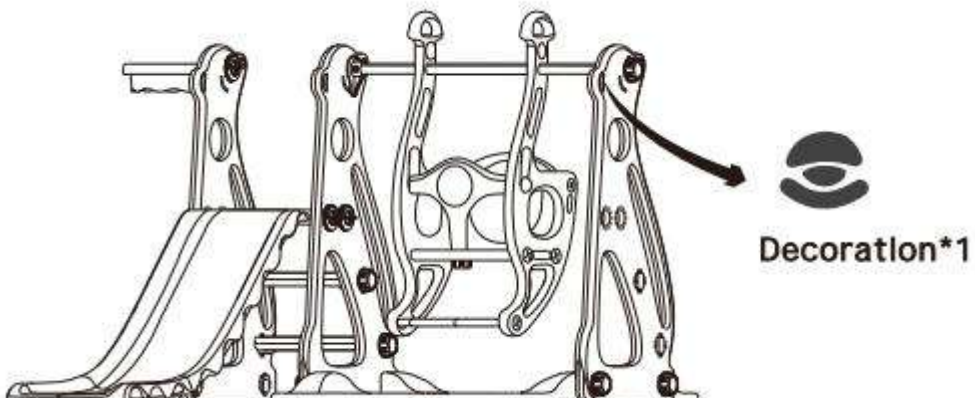

Ensemble de toboggans pour enfants

MANUEL DE L'UTILISATEUR

PP311256

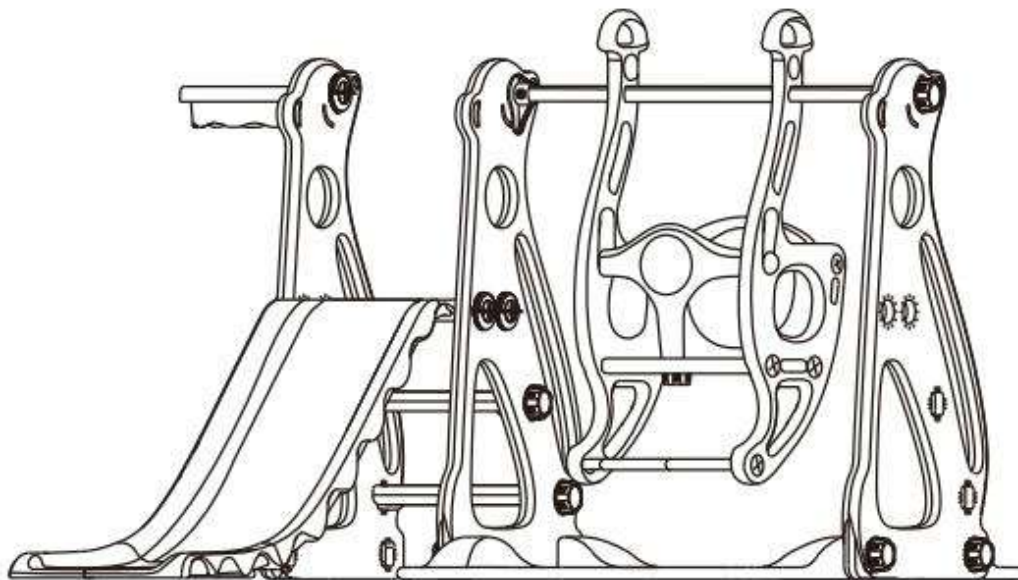

DEMANDE D'ESSAI: EN71
NUMÉRO D'ARTICLE: FE-HT-BJX

LIRE ET CONSERVER CETTE INSTRUCTION POUR UNE
UTILISATION FUTURE

SÉCURITÉ & WARNINGS

ASSEMBLAGE PAR UN ADULTE REQUIS.

- Conservez ces instructions pour référence future.
- Ce produit est destiné à un usage intérieur, familial et domestique uniquement.
- Placez ce produit sur un sol plat et à au moins 2 m pieds d'un parc, d'un bâtiment, de branches aériennes, de cordes à linge ou de fils électriques. Ce produit doit être placé à l'écart des meubles qui pourraient causer des blessures en cas de chute.
- Assurez-vous que la zone d'installation est ventilée.
- N'utilisez pas le produit s'il est endommagé ou défectueux. S'il est endommagé ou défectueux, veuillez contacter un technicien qualifié.
- Vérifiez que toutes les pièces sont bien assemblées et stables avant utilisation. Les pièces défectueuses doivent être remplacées immédiatement car elles peuvent nuire au fonctionnement et à la sécurité du produit.
- Lorsque les températures descendent sous le point de congélation (0°C/32°F), l'utilisation de ce produit à l'extérieur n'est pas recommandée. Par grand froid, les matières plastiques perdent leur résilience et peuvent devenir cassantes et se fissurer sous l'effet de l'impact. Stocker le produit dans un endroit chaud et protégé.
- Tenir à l'écart du feu ou de toute source d'ignition.
- Les matériaux d'emballage ne sont pas des jouets, gardez-les hors de portée des enfants.
- Instruisez les enfants sur l'utilisation appropriée de ce produit : uniquement après l'avoir correctement assemblé et installé, et non d'une manière autre que celle prévue.
- Habillez les enfants de manière appropriée : ne laissez pas les enfants porter des vêtements amples, y compris des ponchos, des écharpes et des vêtements avec des cordons de serrage. Des chaussures bien ajustées doivent toujours être portées.
- Évitez de placer l'équipement à la lumière directe du soleil car les surfaces chaudes pourraient causer de graves brûlures.
- Assurez-vous toujours la surveillance d'un adulte.



MERCI DE NE PAS RETOURNER EN MAGASIN

Veuillez ne pas retourner ce produit au détaillant !!

Nous sommes en mesure de vous aider de TOUTE manière.

Si vous trouvez que vous avez des problèmes avec l'assemblage ou pièces manquantes ou endommagées, veuillez contacter le vendeur

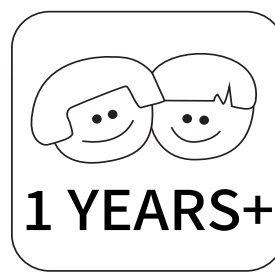

[DE]

Warnung: Dieses Produkt ist nicht für Kinder unter 12 Monaten geeignet.

Warnung: Aufgrund der Kleinteile sollten Kinder das Produkt nur unter Aufsicht von Erwachsenen verwenden, um die Gefahr des Verschluckens zu vermeiden. Verschlucken Sie nicht alle Produkte und Teile, einschließlich Kunststoffteile, Netze, Eisenteile und anderes Zubehör.

Warnung: Um die Sicherheit zu gewährleisten, befolgen Sie bitte die Anweisungen zur korrekten Installation und holen Sie sich bei Bedarf professionelle Hilfe.

Warnung: Stellen Sie Möbel nicht in der Nähe von Feuerquellen oder Gegenständen mit hoher Temperatur auf, um Brandgefahr zu vermeiden. Nur für den Innenbereich.

[EN]

Warning: Not suitable for children under 12 months.

Warning: Due to the small parts of the product, children should only use it under adult supervision to avoid a swallowing hazard. Do not swallow all products and parts, including plastic parts, nets, iron parts, and other accessories.

Warning: To ensure safety, please follow the instructions for correct installation and seek professional assistance if necessary.

Warning: Do not place furniture close to fire sources or high-temperature objects to avoid the risk of fire. For indoor use only.

[FR]

Avertissement : Ce produit ne convient pas aux enfants de moins de 12 mois.

Avertissement : En raison des petites pièces du produit, les enfants ne doivent l'utiliser que sous la surveillance d'un adulte afin d'éviter tout risque d'ingestion. N'avez pas tous les produits et pièces, y compris les pièces en plastique, les filets, les pièces en fer et autres accessoires.

Avertissement : Pour garantir la sécurité, veuillez suivre les instructions pour une installation correcte et demander l'aide d'un professionnel si nécessaire.

Avertissement : Ne placez pas les meubles à proximité de sources d'incendie ou d'objets à haute température pour éviter tout risque d'incendie. Pour une utilisation en intérieur uniquement.

[IT]

Attenzione: Questo prodotto non è adatto ai bambini di età inferiore a 12 mesi.

Attenzione: A causa delle piccole parti del prodotto, i bambini devono utilizzarlo solo sotto la supervisione di un adulto per evitare il rischio di soffocamento. A causa delle piccole parti del prodotto, i bambini devono usarlo solo sotto la supervisione di un adulto per evitare il rischio di ingestione. Non ingerire tutti i prodotti e le parti, comprese le parti in plastica, le reti, le parti in ferro e altri accessori.

Attenzione: Per garantire la sicurezza, seguire le istruzioni per una corretta installazione e, se necessario, richiedere assistenza professionale.

Attenzione: Non posizionare i mobili vicino a fonti di fuoco o oggetti ad alta temperatura per evitare il rischio di incendio. Solo per uso interno.

[ES]

Advertencia: Este producto no es adecuado para niños menores de 12 meses.

Advertencia: Debido a las pequeñas piezas del producto, los niños sólo deben utilizarlo bajo la supervisión de un adulto para evitar el riesgo de asfixia. No trague todos los productos y piezas, incluidas las piezas de plástico, las redes, las piezas de hierro y otros accesorios.

Advertencia: Para garantizar la seguridad, siga las instrucciones para una instalación correcta y busque asistencia profesional si es necesario.

Advertencia: No coloque muebles cerca de fuentes de fuego u objetos de alta temperatura para evitar el riesgo de incendio. Solo para uso en interiores.



Importeur	Decobus Handel GmbH		
Adresse	Innungsstraße 9, 21244 Buchholz, Deutschland		
URL	https://www.decobusgroup.de		
Hersteller	Yongjia Feiqi Toy Co.,Ltd		
Adresse	Bali Industrial Zone,QiaoXiaTown,WenzhouCity,Zhejiang		
Email/URL	exp08@feelkids.com		
<table border="1"><tr><td>EC</td><td>REP</td></tr></table>	EC	REP	Decobus Handel GmbH Innungsstraße 9, 21244 Buchholz, Deutschland https://www.decobusgroup.de
EC	REP		



Declaration OF COMPLIANCE

Report No. CTT2211031480EN **Issued Date:** Feb.06, 2023

This certificate of conformity is based on an evaluation of a sample of the following mentioned product, and technical report and documentation are at the license holder's disposal. This is to certify that the tested sample is in conformity with all related provisions as follows: 1. EN71 under Toys Directive 2009/48/EC; It is possible to use CE marking to demonstrate the compliance with this toys Directive.

Sample Name: Slide
Age Group: 12M+
Applicant: YONGJIA FEIQI TOY CO., LTD
Address: BALI, QIAOXIA TOWN, YONGJIA COUNTY, WENZHOU CITY, ZHEJIANG PROVINCE.CHINA

Model No.: FE-HT-XXX、FE-HT-XLB、L-HT22、FE-HT-BJX、FE-HT-XKL、FE-HT-KAL、FE-HT-XG0、L-DX001R、FE-HT-KAG、FE-HT-MYY、FQ-HT-QDPC、FQ-HT-QDPP、L-XS01、FE-HT-DG1、L-CJL001、L-KL001、L-NLL001、L-NLL002、FQ-H001、FQ-H003、FQ-CL02、L-HT01R、L-DC01

Measurement Items: EN71-1 Mechanical & Physical Test/EN71-2 Flammability Test/EN71-3 Migration of certain elements/EN 71-8 Activity toys for domestic use

The certificate applies to the tested sample above mentioned only and shall not imply an assessment of the whole production. It is only valid in connection with the test report (Report No. CTT2211031480EN)



Signed for and on Behalf of CTT



Frank / Lab manager
Consumer Testing Technology Co., Ltd.

LISTE DES PIÈCES 1

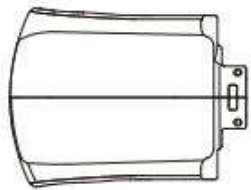

Étendre la zone *1

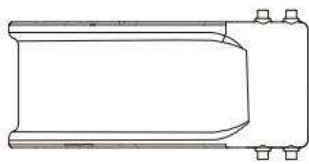

Diapositive principale *1



Accoudoir pivotant*1



Siège*1



Décoration *1



Panier de basket*3



Basket-ball*1

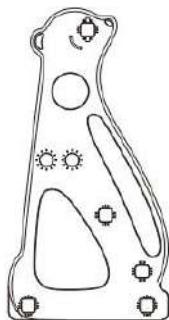

Panneau latéral *3



Tube de fer *1

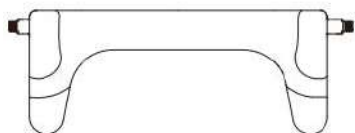

Fond basculant *2

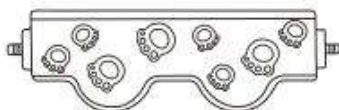

Pagaie balançoire*1



Escalier *2



Panneau latéral pivotant *2



Écrou A *2



Écrou B *8

PART LIST 2



Écrou C*1



Écrou D*4

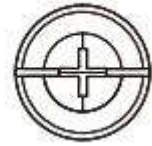

Écrou E*5



Écrou F *10



Écrou G*2



Écrou H *2



Prise d'eau*2



Outil*1

ASSEMBLÉ

1. Connectez la zone d'extension avec la glissière et serrez avec l'écrou A * 2 à l'arrière.

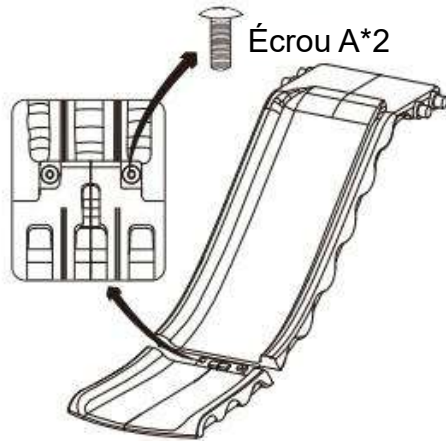

2. Connectez la glissière installée à l'étape 1 avec le panneau latéral avec l'écrou E.



3. Insérez l'escalier dans le panneau latéral et serrez avec l'écrou F.

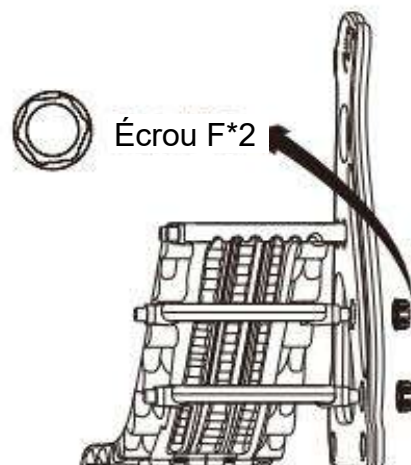

4. Connectez un autre panneau latéral avec les écrous E et F.

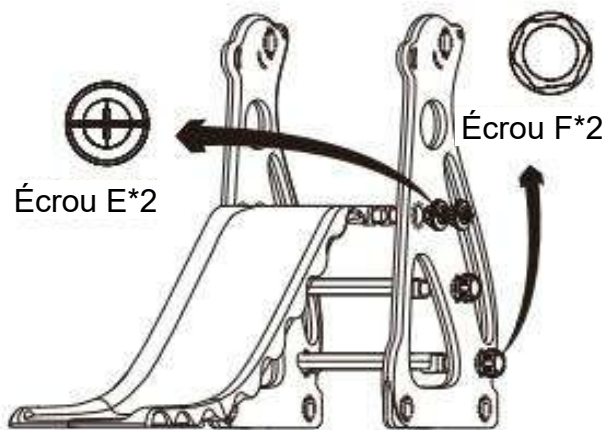

5. Insérez le bas de la glissière dans le panneau latéral et serrez avec l'écrou F.

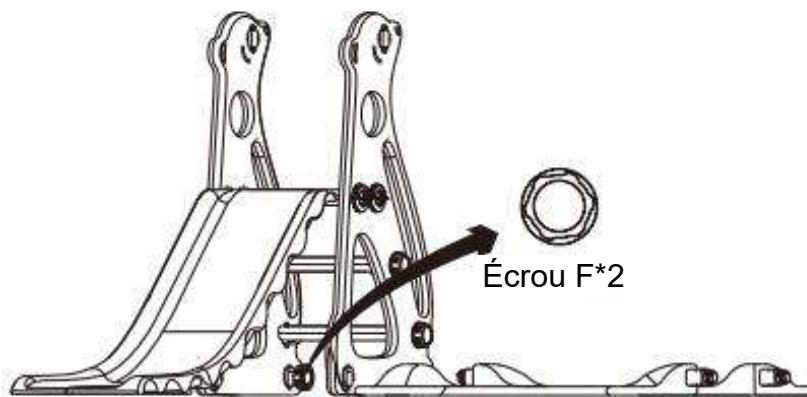

6. Fixez le tube de fer aux panneaux latéraux avec l'écrou G et serrez avec l'écrou H et l'écrou F.

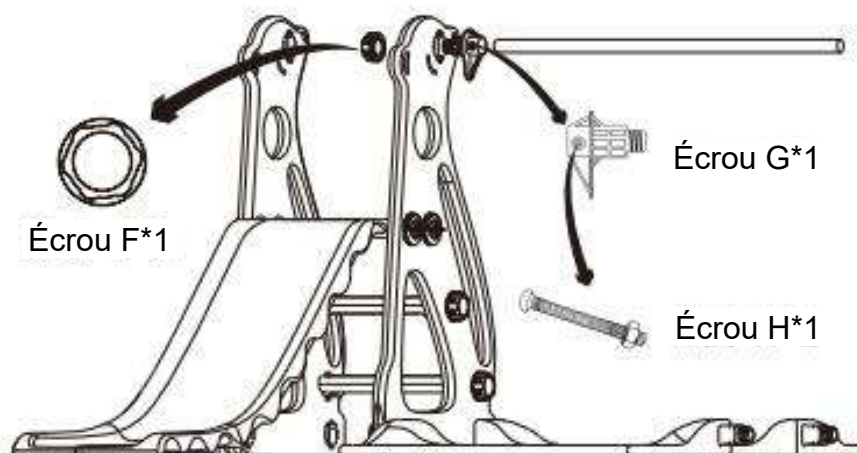

7. Assemblez le siège, serrez avec l'écrou C et l'écrou B.

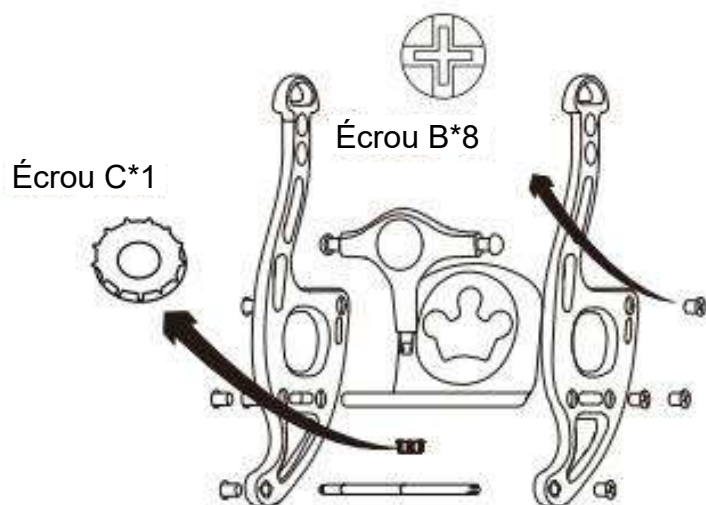

8. Insérez la balançoire dans le tube de fer et serrez avec l'écrou D.

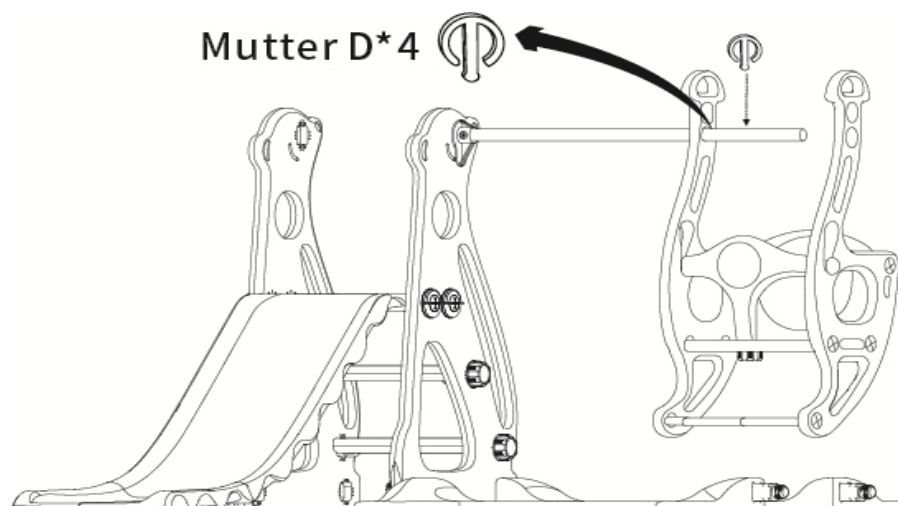

9. Utilisez l'écrou H pour serrer l'écrou G.

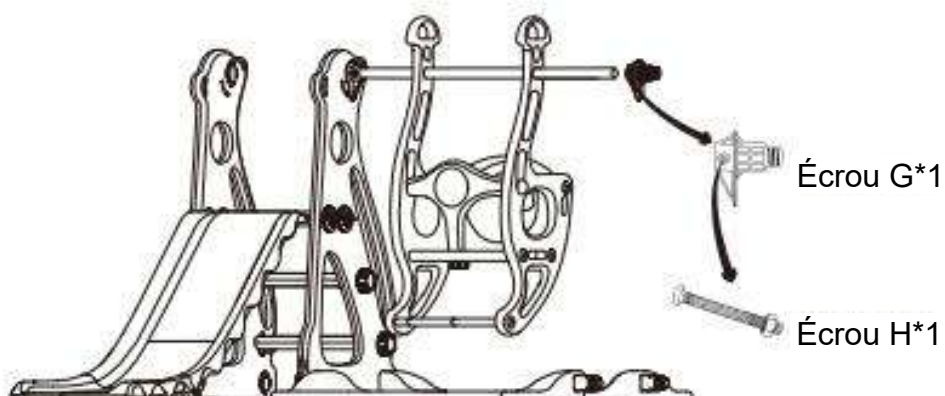

10. Connectez le tube de fer avec un autre panneau latéral et serrez avec l'écrou F.

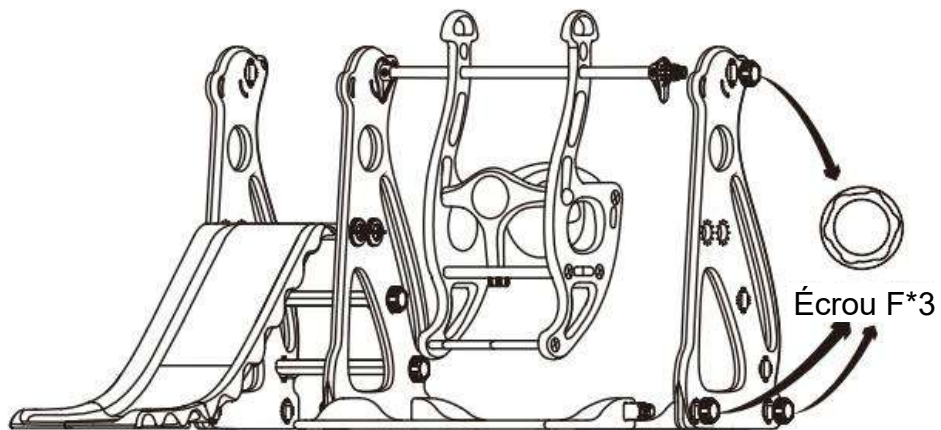

11. Utilisez l'écrou E pour serrer le panier de basket.

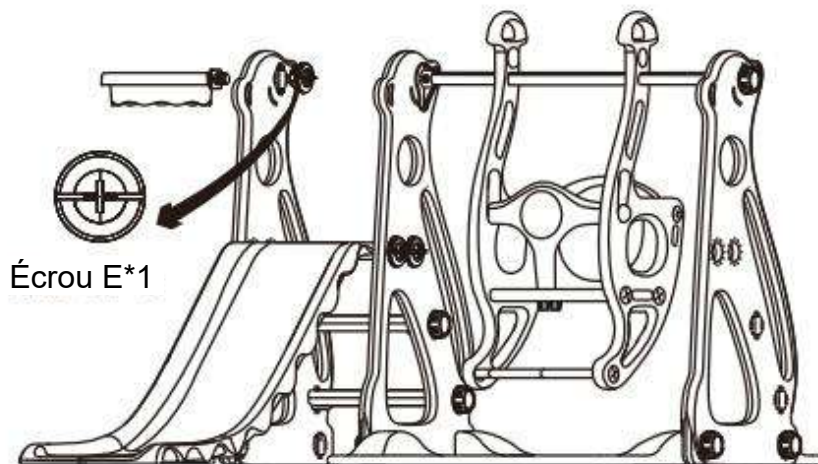

12. Ajoutez des décorations, le produit est complètement assemblé.

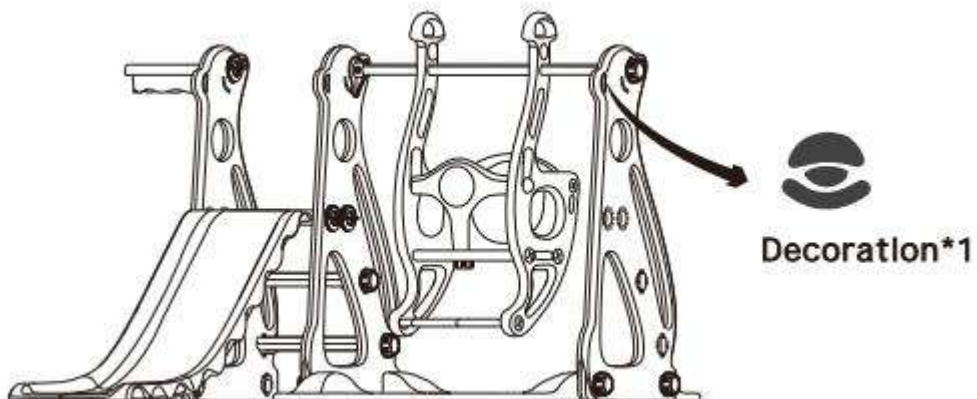



Declaration OF COMPLIANCE

Report No. CTT2211031480EN **Issued Date:** Feb.06, 2023

This certificate of conformity is based on an evaluation of a sample of the following mentioned product, and technical report and documentation are at the license holder's disposal. This is to certify that the tested sample is in conformity with all related provisions as follows: 1. EN71 under Toys Directive 2009/48/EC; It is possible to use CE marking to demonstrate the compliance with this toys Directive.

Sample Name: Slide
Age Group: 12M+
Applicant: YONGJIA FEIQI TOY CO., LTD
Address: BALI, QIAOXIA TOWN, YONGJIA COUNTY, WENZHOU CITY, ZHEJIANG PROVINCE.CHINA

Model No.: FE-HT-XXX、FE-HT-XLB、L-HT22、FE-HT-BJX、FE-HT-XKL、FE-HT-KAL、FE-HT-XG0、L-DX001R、FE-HT-KAG、FE-HT-MYY、FQ-HT-QDPC、FQ-HT-QDPP、L-XS01、FE-HT-DG1、L-CJL001、L-KL001、L-NLL001、L-NLL002、FQ-H001、FQ-H003、FQ-CL02、L-HT01R、L-DC01

Measurement Items: EN71-1 Mechanical & Physical Test/EN71-2 Flammability Test/EN71-3 Migration of certain elements/EN 71-8 Activity toys for domestic use

The certificate applies to the tested sample above mentioned only and shall not imply an assessment of the whole production. It is only valid in connection with the test report (Report No. CTT2211031480EN)



Signed for and on Behalf of CTT

Frank



Frank / Lab manager
Consumer Testing Technology Co., Ltd.