

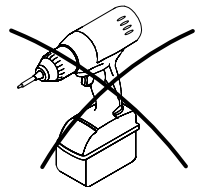

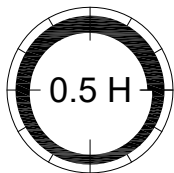

MALTA

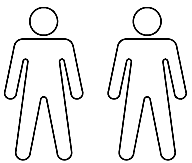

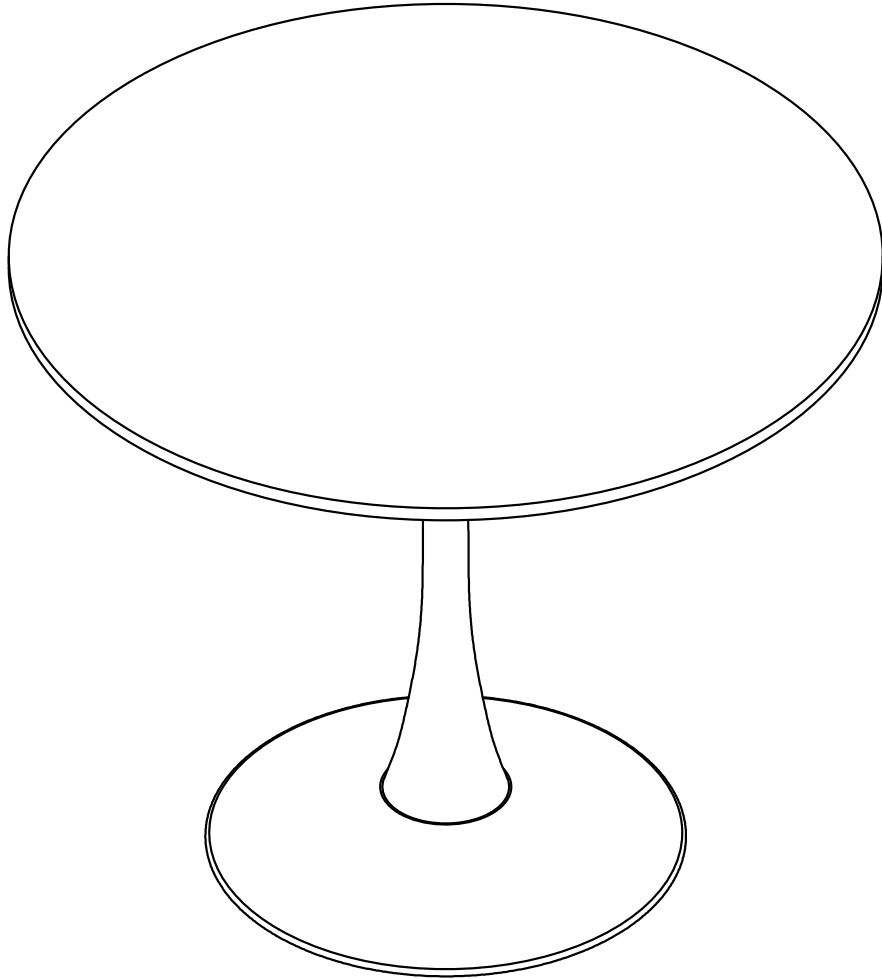
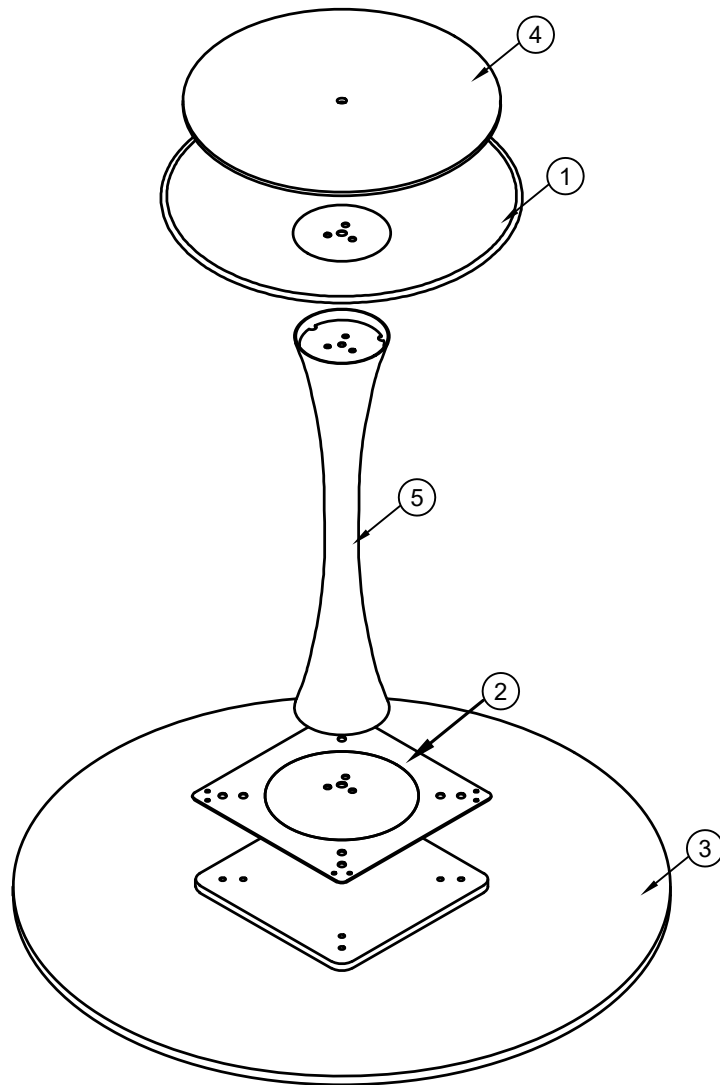
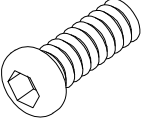
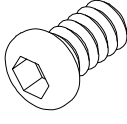
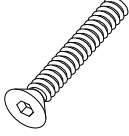

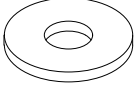

			✓
①	1	Ø495X70	
②	1	293X293X16	
③	1	Ø900X11	
④	1	Ø436X6	
⑤	1	Ø133X628	



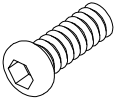

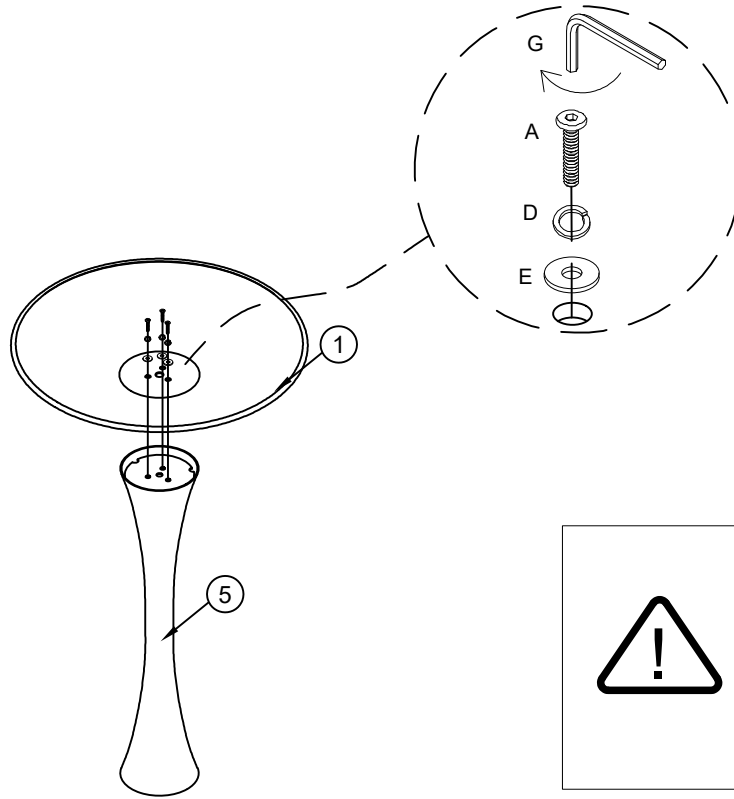

<p>A x 6</p>  <p>M8x30 mm</p>	<p>B x 8</p>  <p>M8x16 mm</p>	<p>C x 1</p>  <p>M10x90 mm</p>	<p>D x 6</p>  <p>Ø9/Ø13 mm</p>	<p>E x 14</p>  <p>Ø8/Ø16 mm</p>
<p>F x 1</p>  <p>6 mm</p>	<p>G x 1</p>  <p>5 mm</p>			

1

A x 3  M8x30 mm	D x 3  Ø9/Ø13 mm	E x 3  Ø8/Ø16 mm	G x 1  5 mm
--------------------------------------------------------------------------------------------------------	---------------------------------------------------------------------------------------------------------	---------------------------------------------------------------------------------------------------------	----------------------------------------------------------------------------------------------------

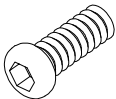

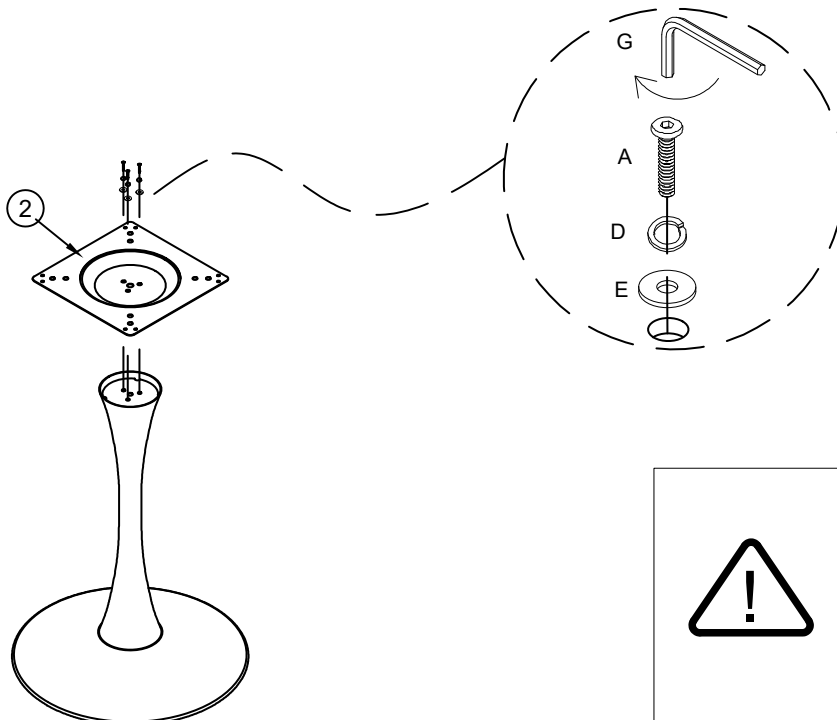

2

A x 3  M8x30 mm	D x 3  Ø9/Ø13 mm	E x 3  Ø8/Ø16 mm	G x 1  5 mm
----------------------------------------------------------------------------------------------------------	-----------------------------------------------------------------------------------------------------------	-----------------------------------------------------------------------------------------------------------	------------------------------------------------------------------------------------------------------



3

B x 8  M8x16 mm	E x 8  Ø8/Ø16 mm	G x 1  5 mm
--------------------------------------------------------------------------------------------------------	---------------------------------------------------------------------------------------------------------	----------------------------------------------------------------------------------------------------

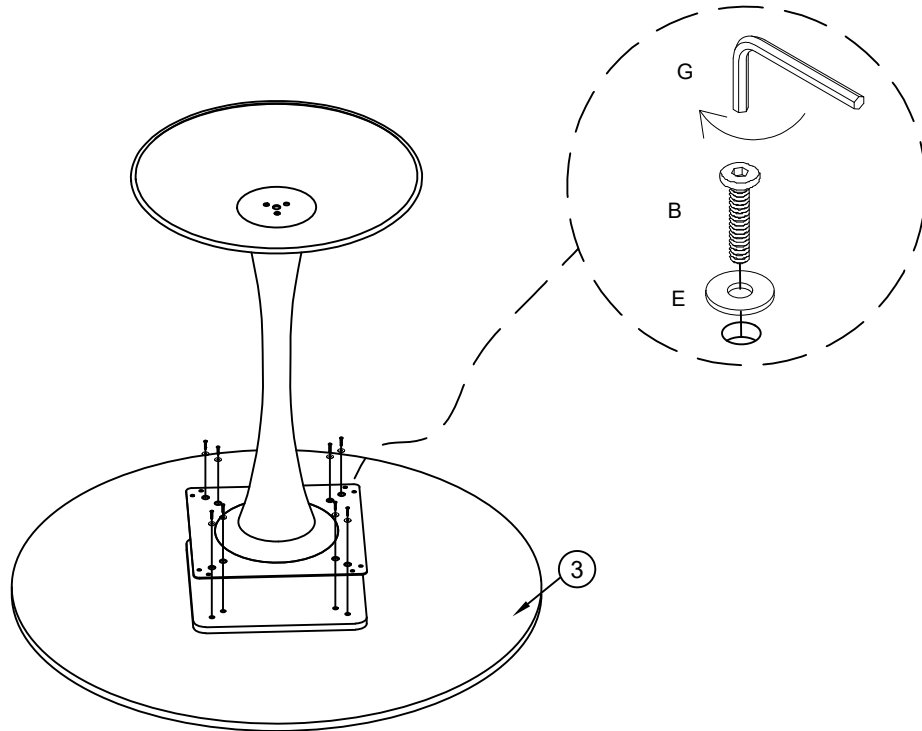

4

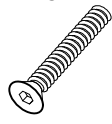
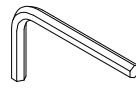
C x 1  M10x90 mm	F x 1  6mm
-----------------------------------------------------------------------------------------------------------	-----------------------------------------------------------------------------------------------------

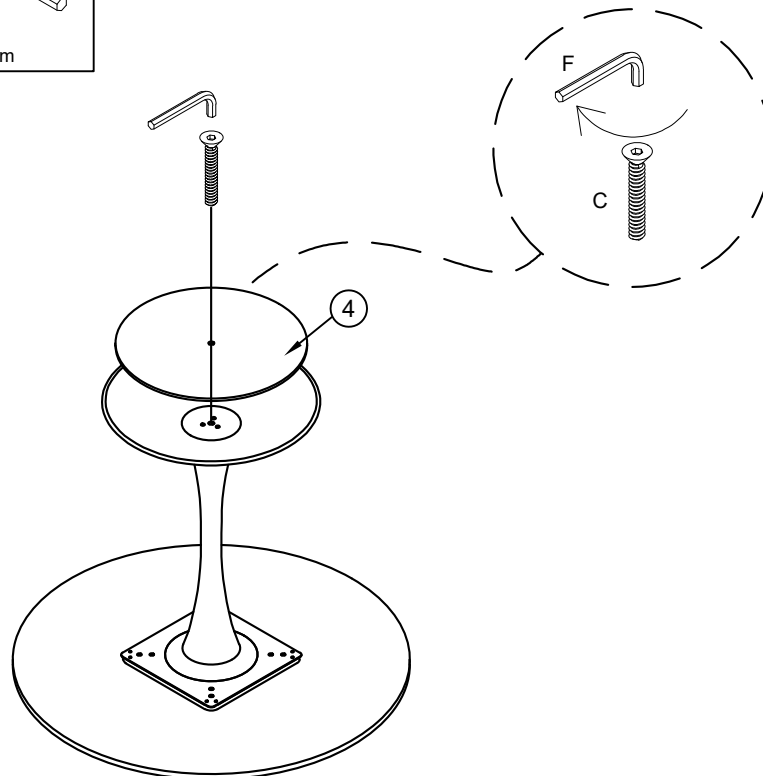

5

