

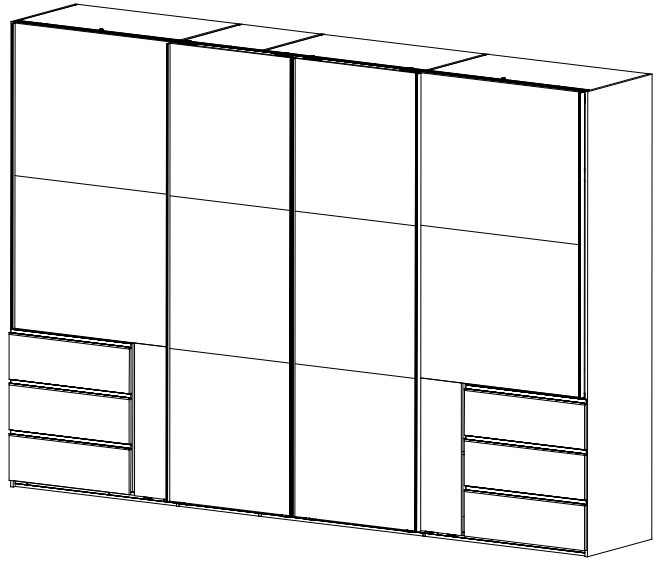

980794

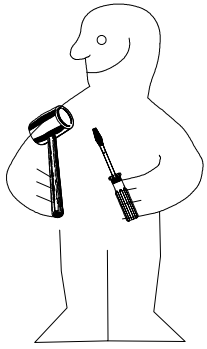

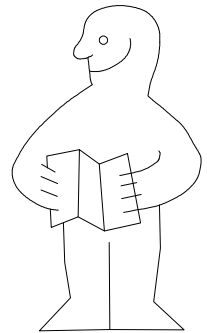

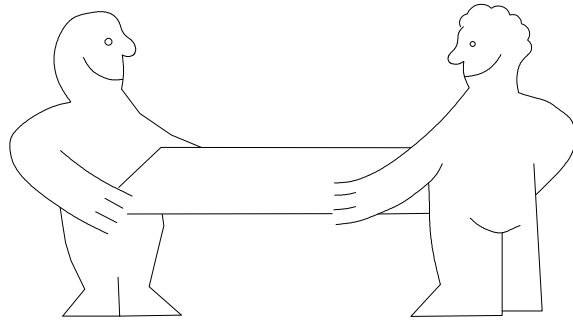
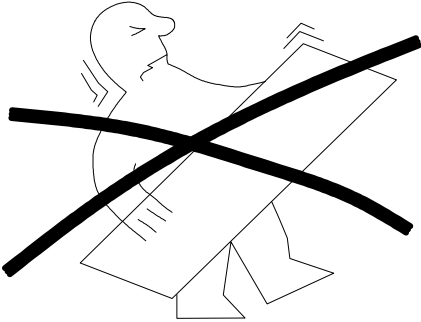



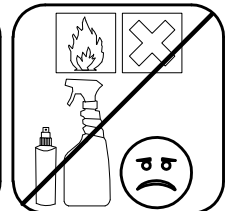
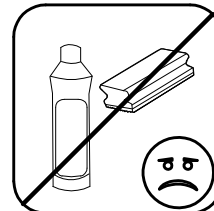
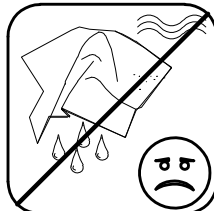
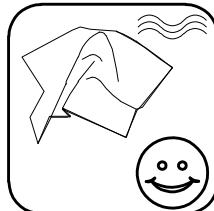
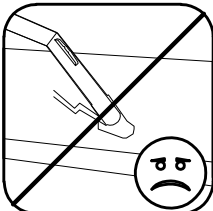
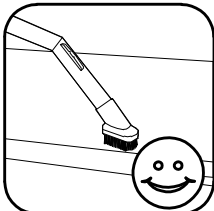
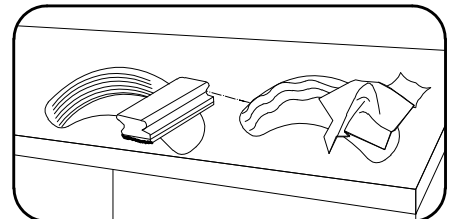
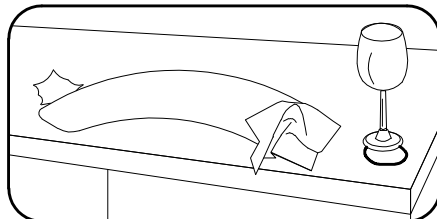
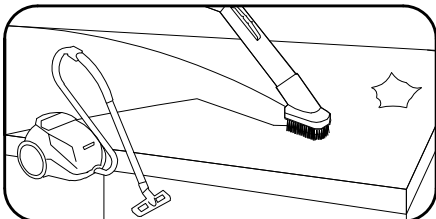
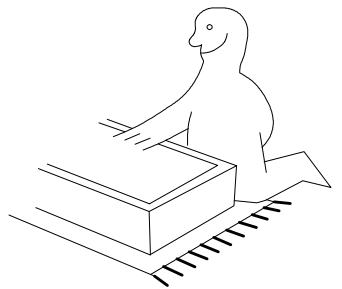
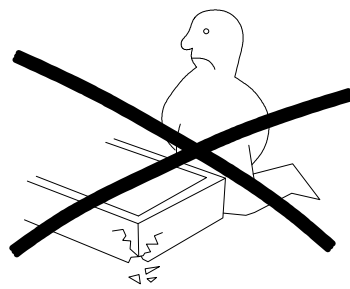
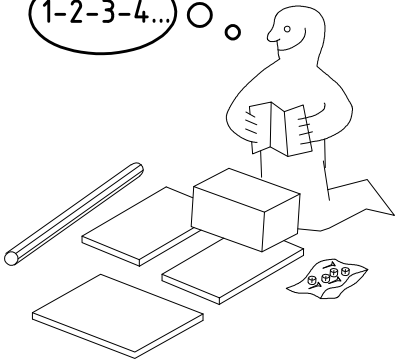



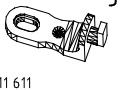
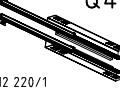
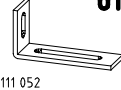
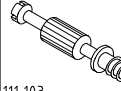

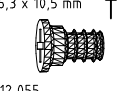
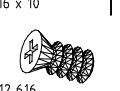

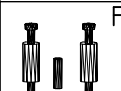
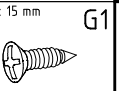
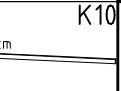
SHSP 350 4-trg Sy ASK

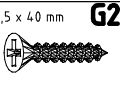
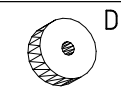
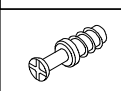

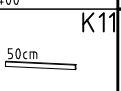
1-2-3-4... ○

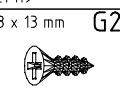
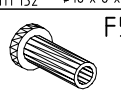
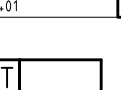
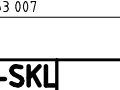
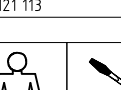

 A1 111 xxx	32x	 S0 111 300	19x	 K2 117 002	8x	 J2 111 611	19x	 Q45 112 220/1	6x	 o10 111 052	1x
 C 111 103	8x	 V12 111 xxx φ12 3,5 x 15 mm	19x	 SBV	40x	 T1 6,3 x 10,5 mm	48x	 T3 M6 x 10	12x	 SP13 4 x 13mm	4x
 F3	12x	 G1 121 370	62x	 K10 100cm	3x	 L8 112 055	32x	 G25 3,5 x 40 mm	14x	 D8 112 616	12x
 F 111 229	8x	 VB23 121 252	8x	 K11 50cm	1x	 Z 111 607	4x	 G21 3 x 13 mm	24x	 F5 111 152 φ18 x 8 x 4	12x
				 112 400		 163 007		 121 113		 111 xxx φ5 x 15 x M4	

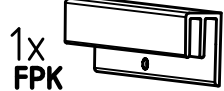

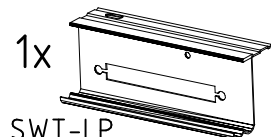

1x FPK
1453/1940/2430/2920/3408







1x SWT-LP
1453/1940/2430/2920 SY
/3410 SY

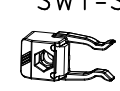

914652800

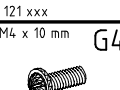
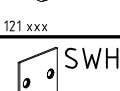
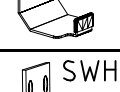
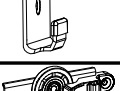
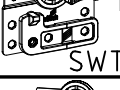
 G1 3,5 x 15 mm 121 370	2x	 SWT 1	4x	 SWT 2	2x
--	----	---	----	---	----

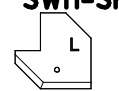
 SWT-ST	2x	 SWT-SM5 M4 x 13 mm	2x	 GH13 121 xxx	8x	 G43 M4 x 10 mm	8x	 SWH 6	4x	 SWH 7	4x	 L SWT 8	1x	 R SWT 9	1x
--	----	---	----	---	----	---	----	--	----	---	----	--	----	--	----

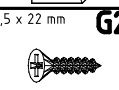
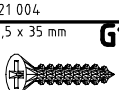
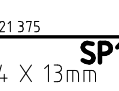
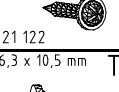
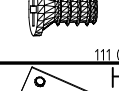
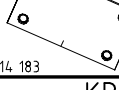
 SWH-SKL L	1x	 SWH-SKR R	1x	 G24 3,5 x 22 mm	10x	 G14 121 004 3,5 x 35 mm	2x	 SP13 4 x 13mm	146x	 T2 121 122 6,3 x 10,5 mm	34x	 H5 111 030	10x	 KP8 114 183	4x
--	----	--	----	--	-----	---	----	---	------	--	-----	---	-----	--	----

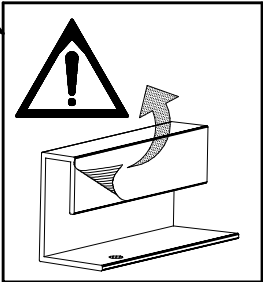
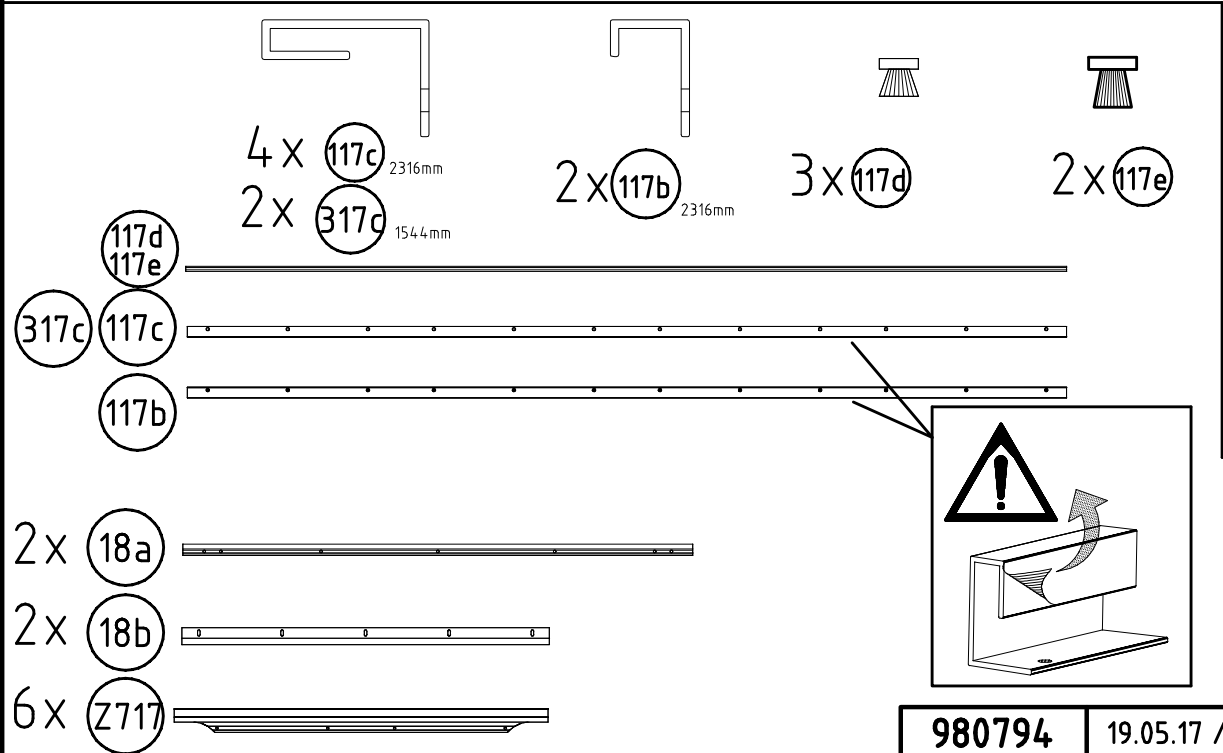
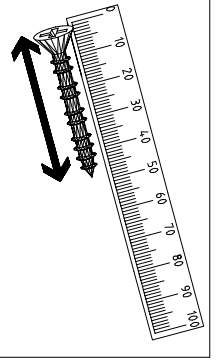
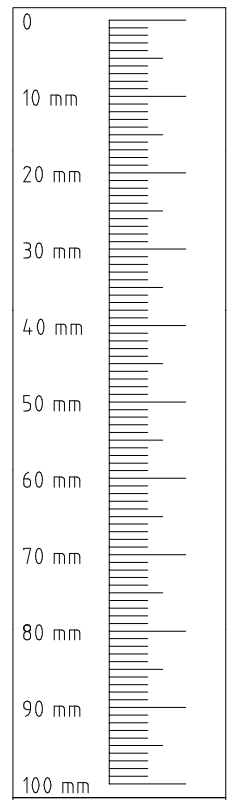
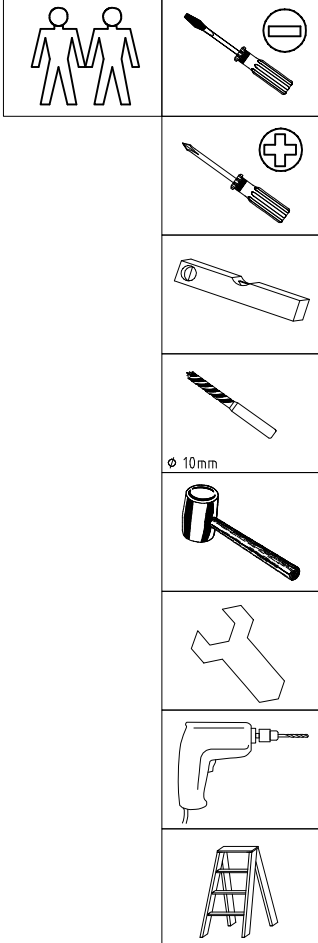

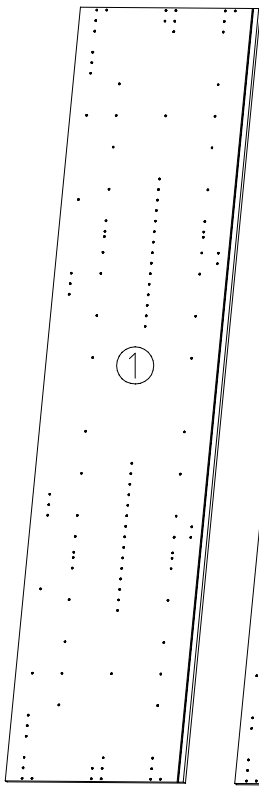

①

2352x577x15

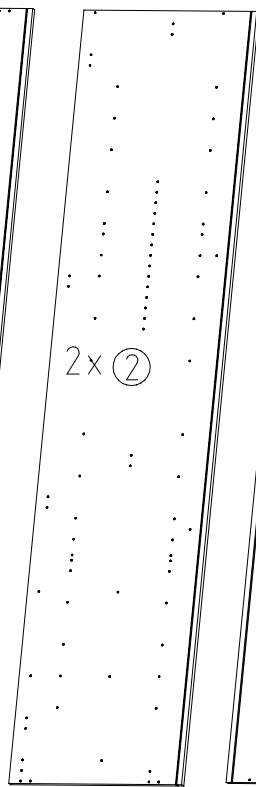

2x ②

2352x560x15

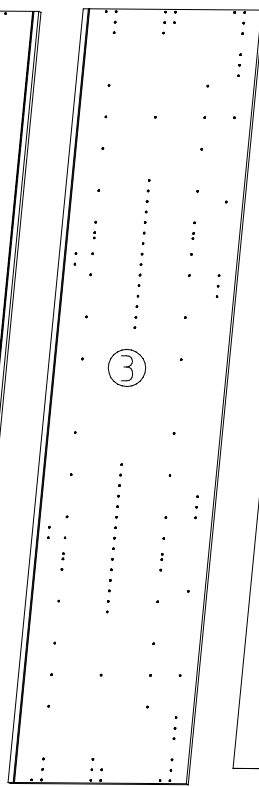

③

2352x577x15

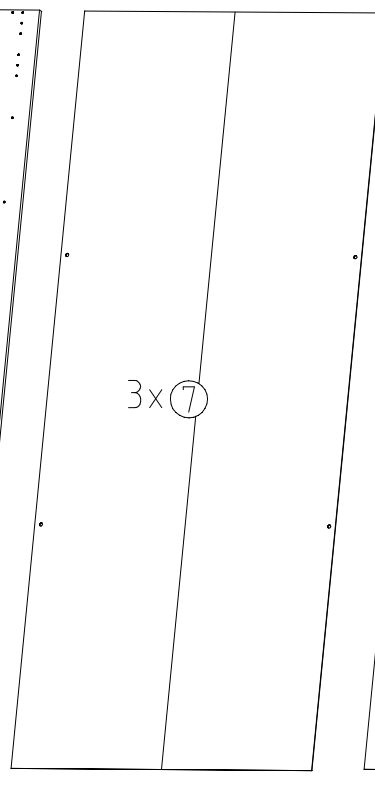

3x ⑦

2303x973x2,5

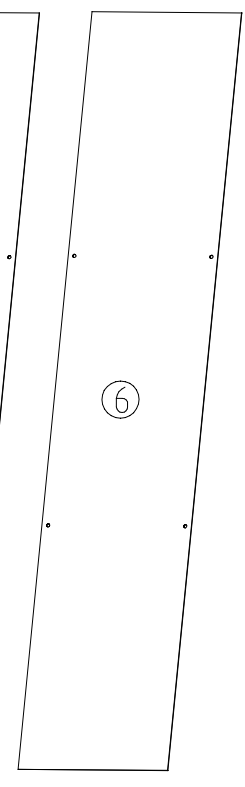

⑥

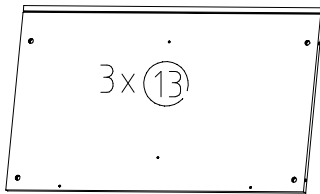

3x ⑬

964x560x15

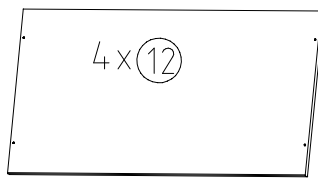

4x ⑫

964x500x18

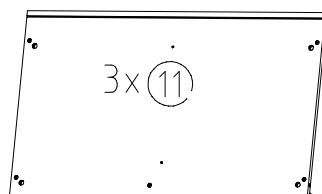

3x ⑪

964x560x47

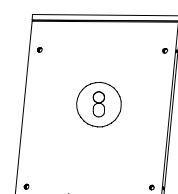

⑧

475x560x15

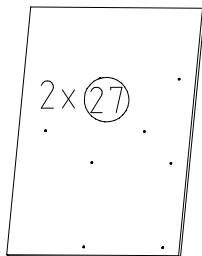

2x ⑳

753x557x15

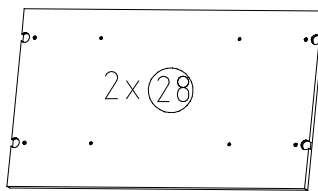

2x ㉘

964x540x22



2x ㉙

250x500x18

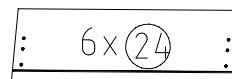

6x ㉜

717x227x15

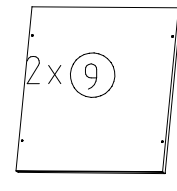

2x ⑨

475x500x18

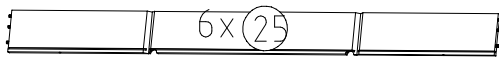

6x ㉝

450/675/450x126x12

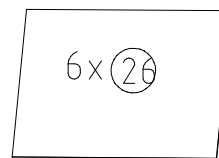

6x ㉞

661x449x2,5

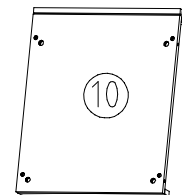

⑩

475x560x47

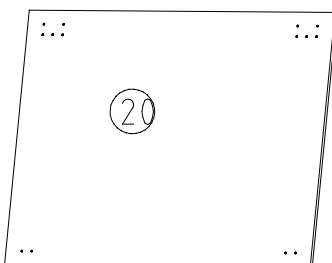

⑳

4x 990x772x15

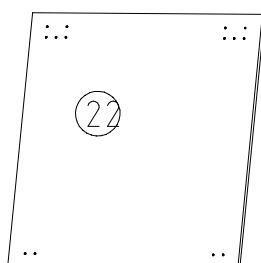

㉒

6x 745x772x15

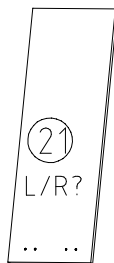

㉑
L/R?

2x268x772x15

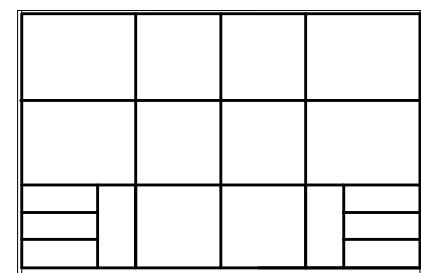

L M M R

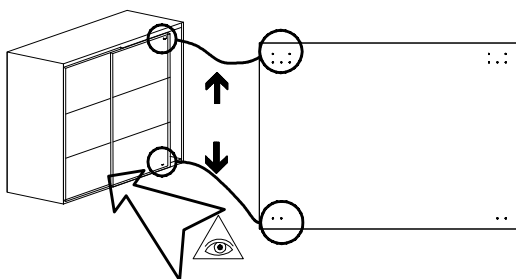

1

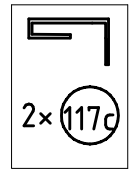
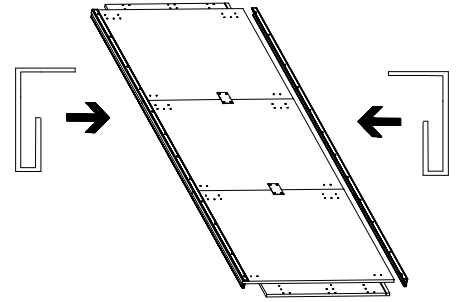
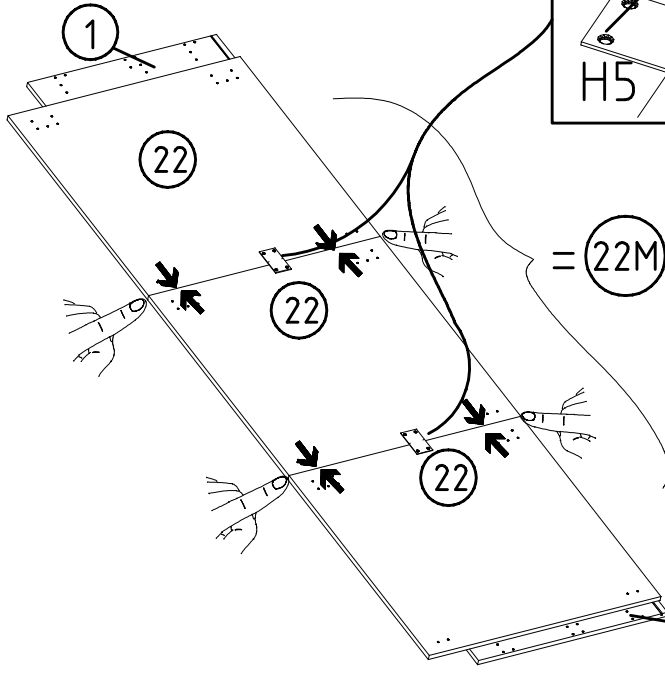
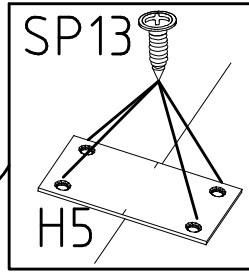
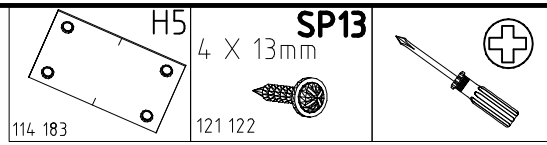
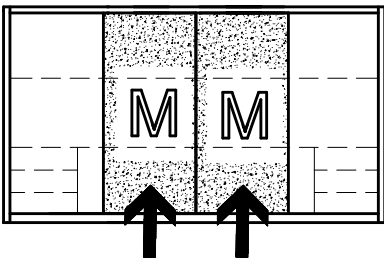

2

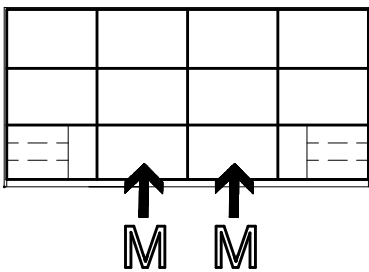
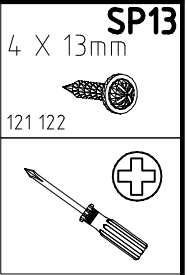
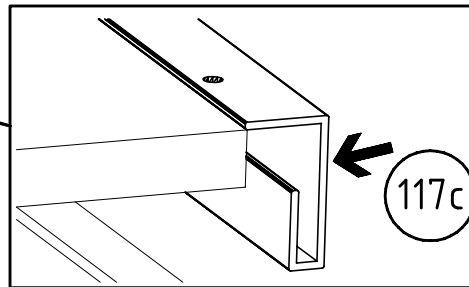
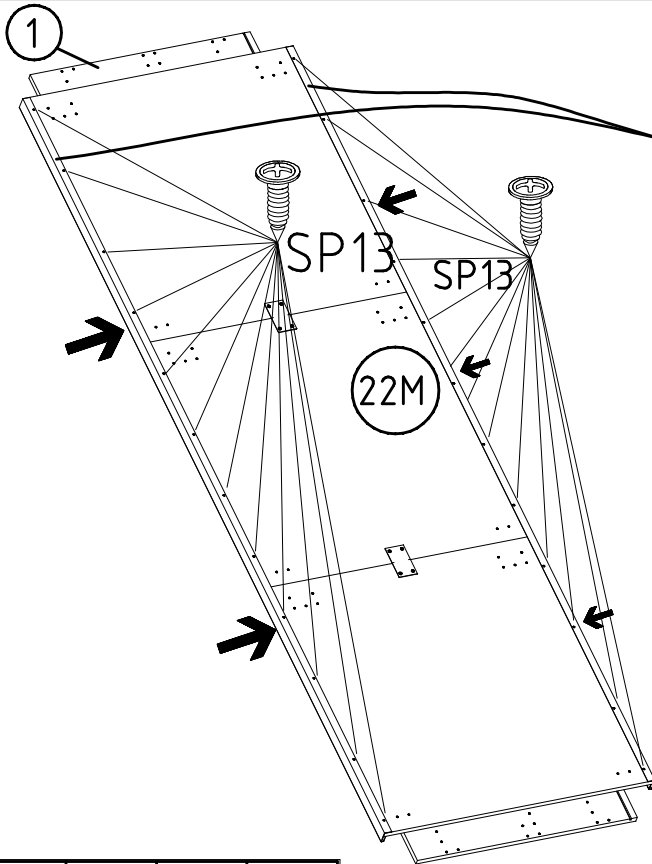

3

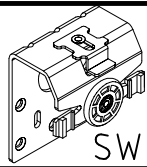

SWT 1

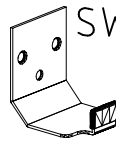

SWH 6

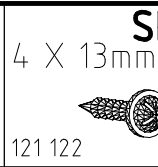

SP13
4 X 13mm
121 122

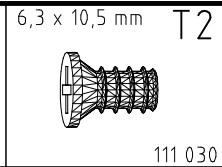

6,3 x 10,5 mm T2
111 030

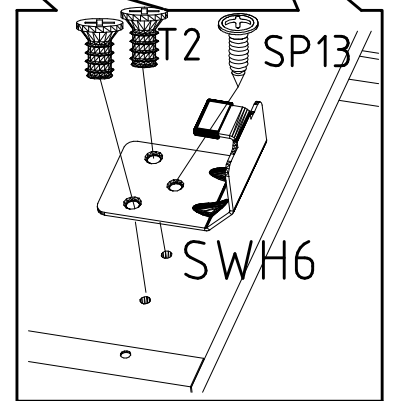
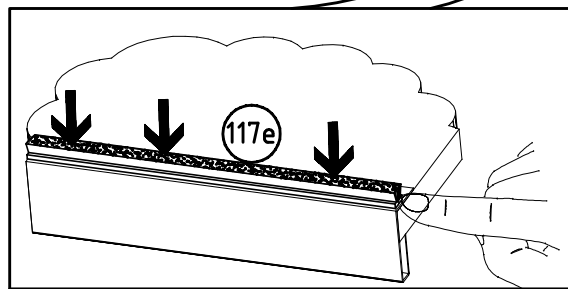
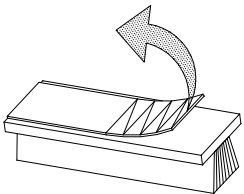
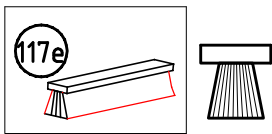
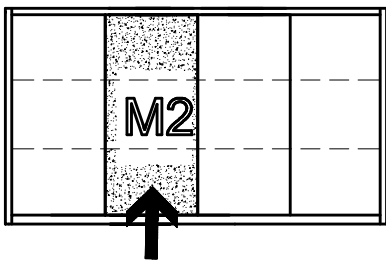
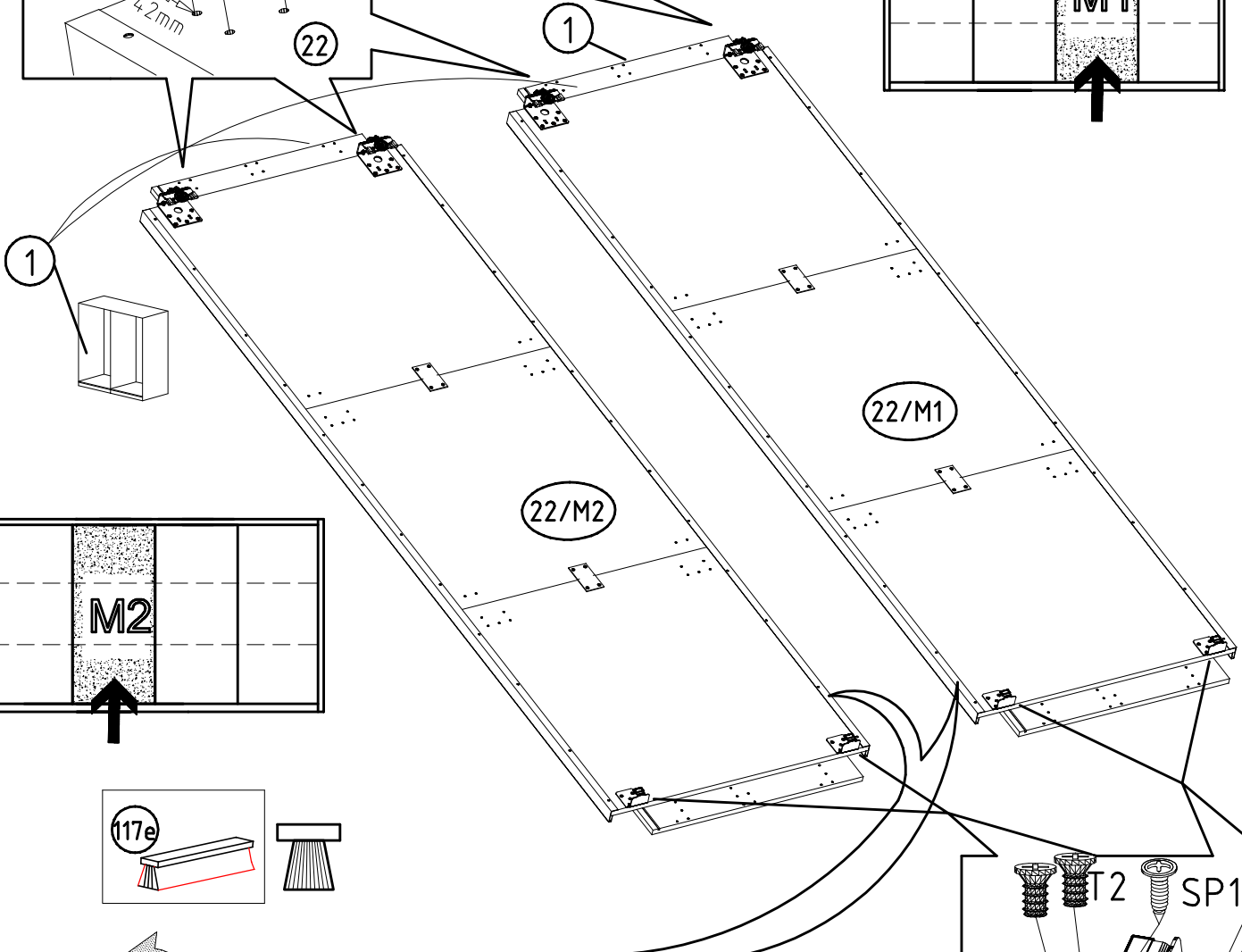
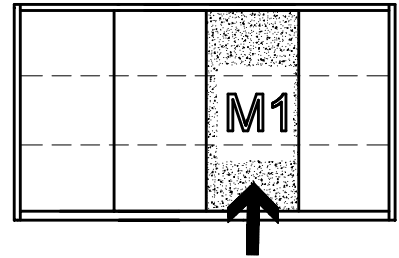
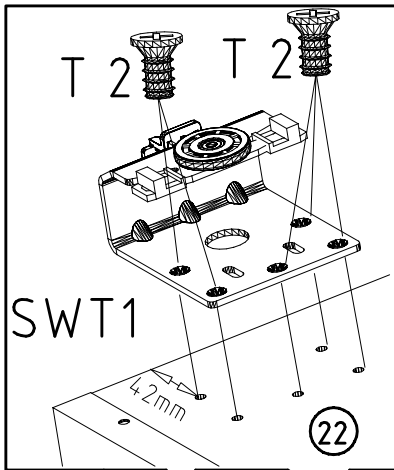
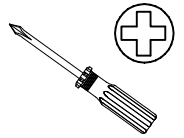

4

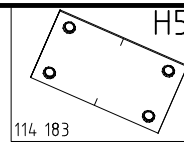
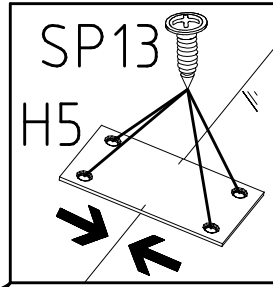
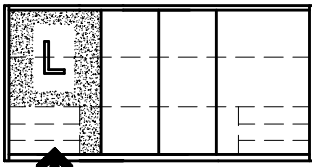

SP13
4 X 13mm
121 122

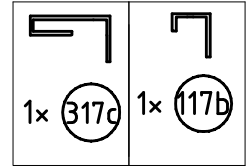
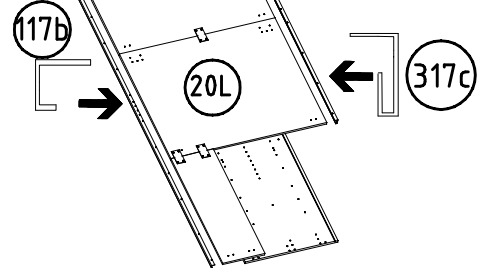
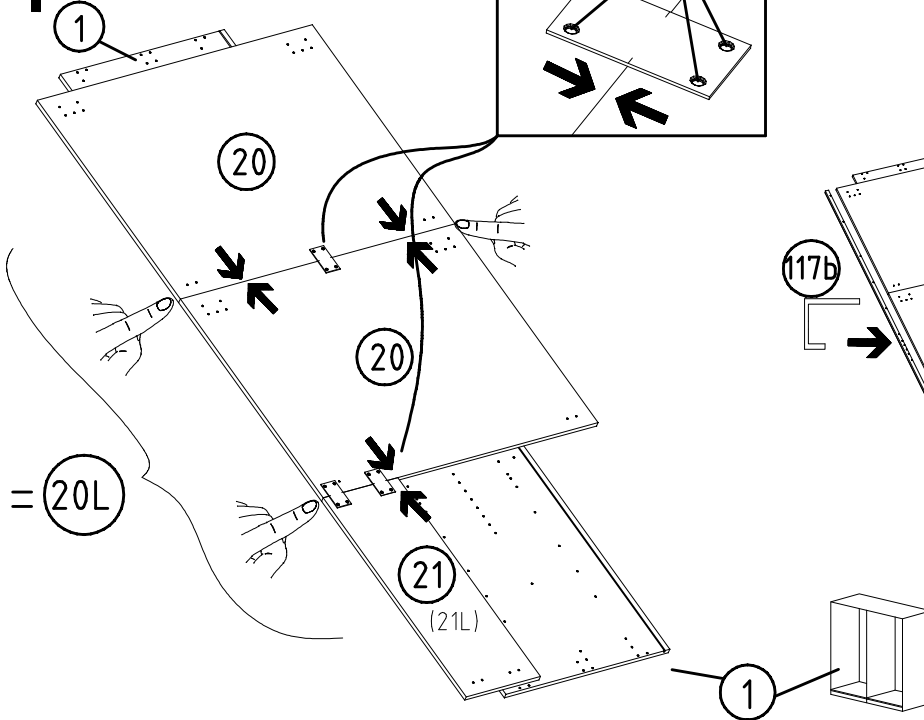
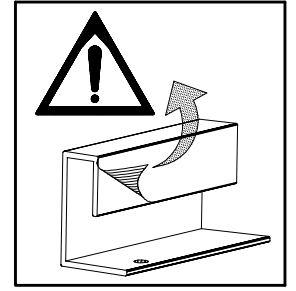
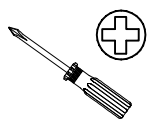

5

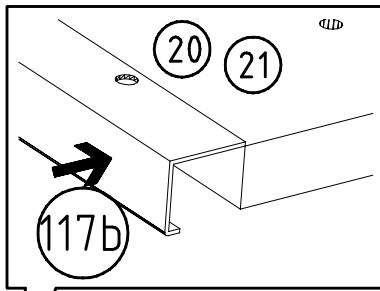

SP13
4 X 13mm
121 122

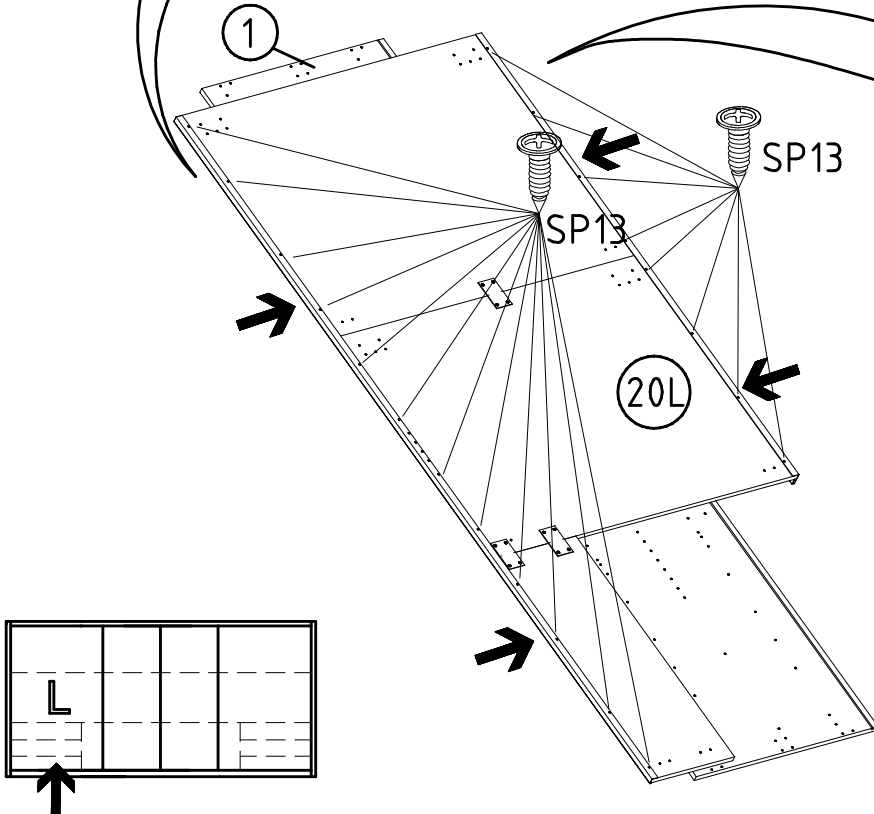
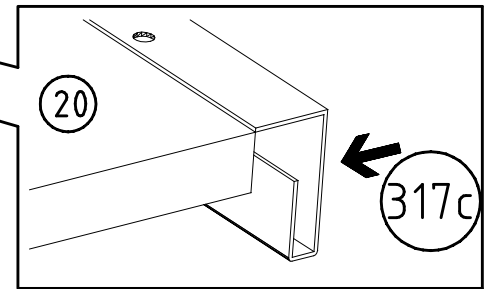

6

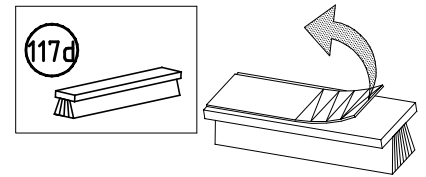
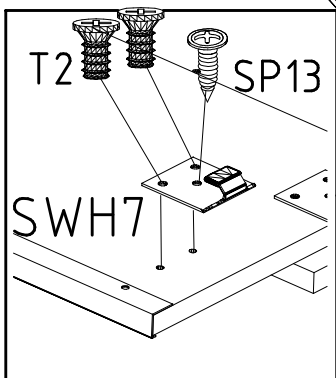
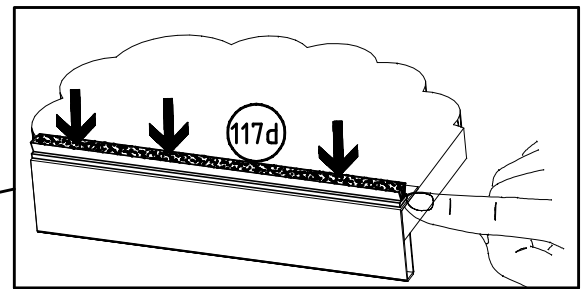
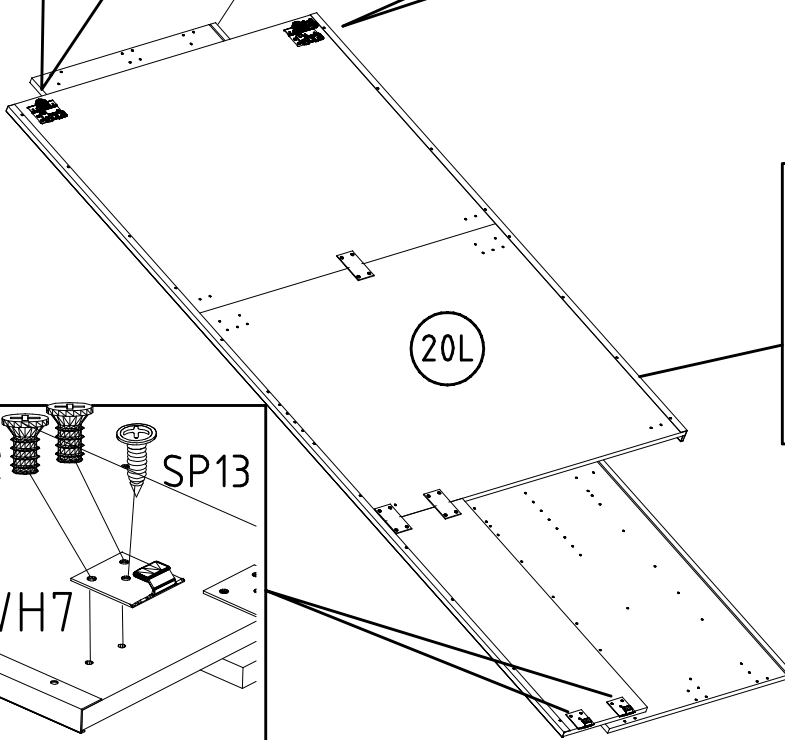
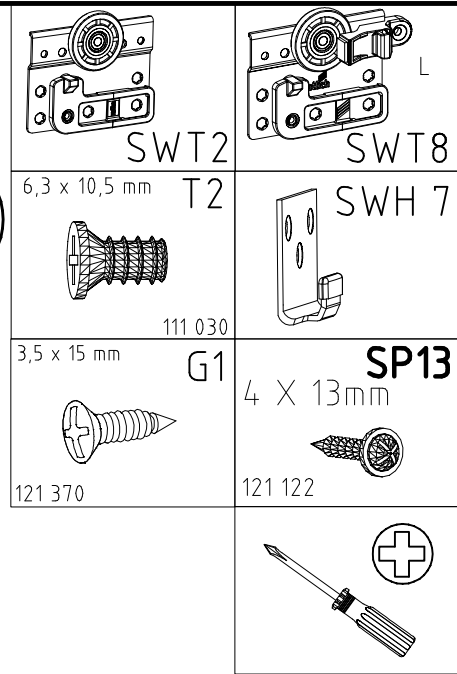
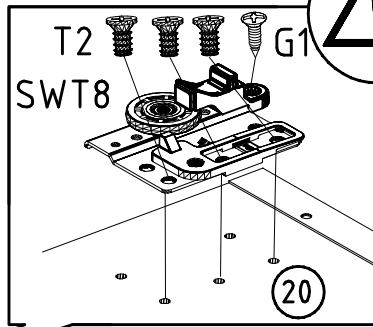
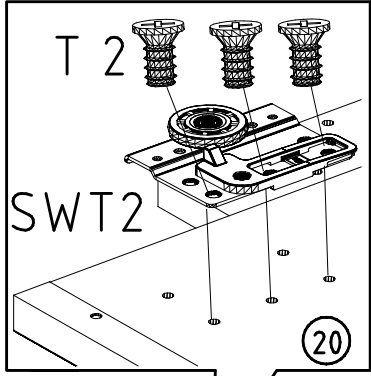
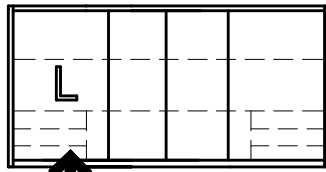

7

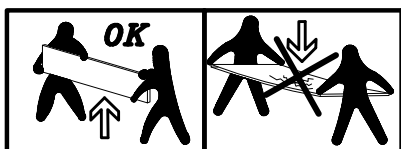
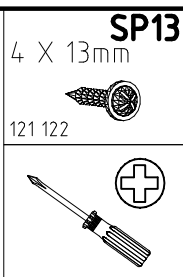
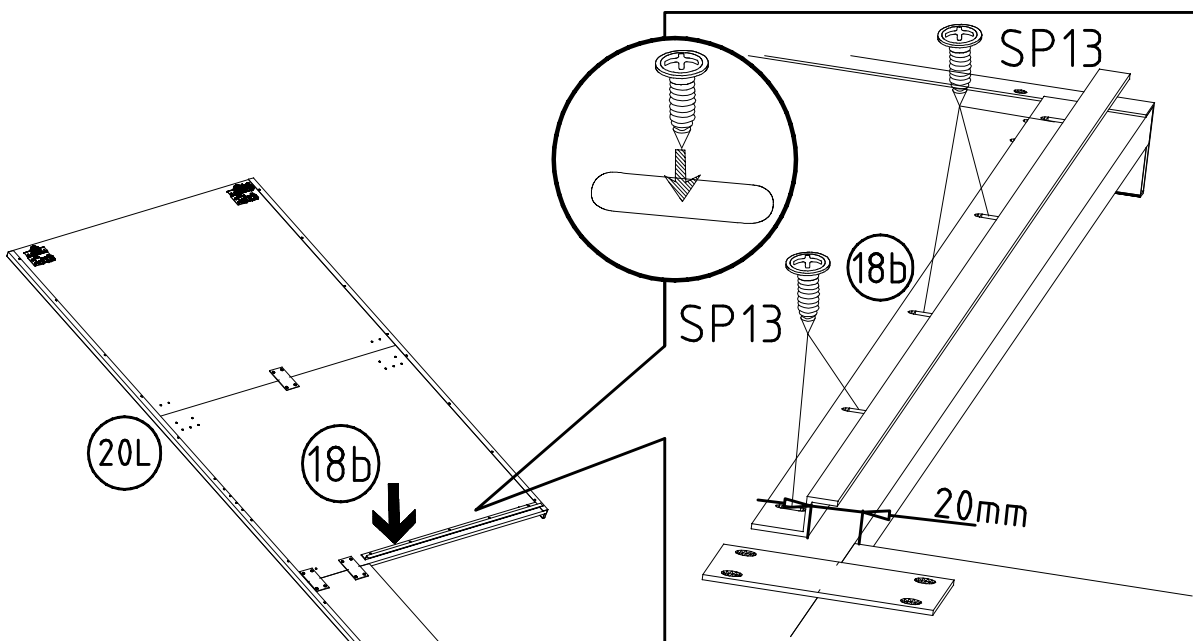

8

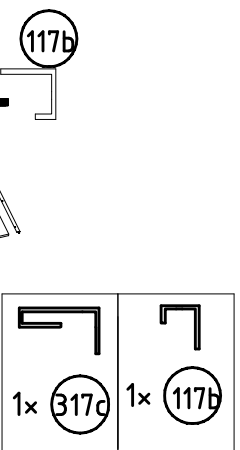
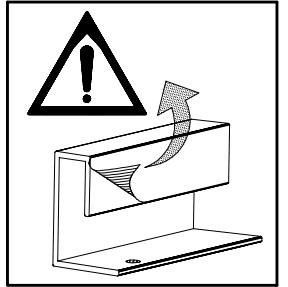
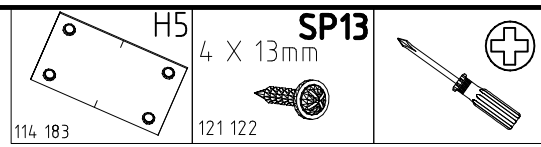
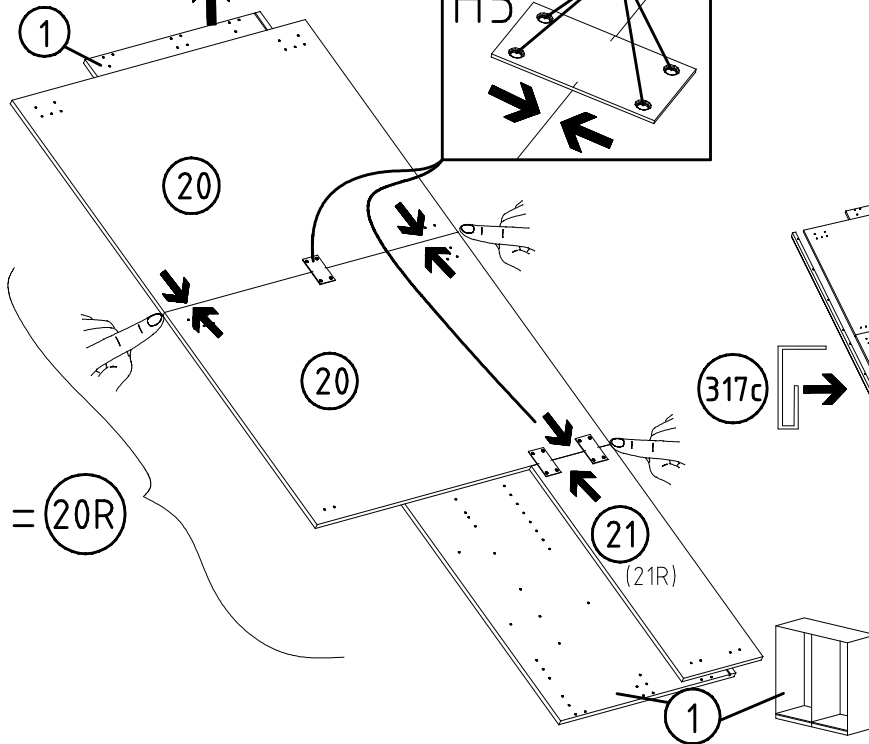
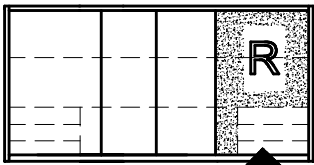

9

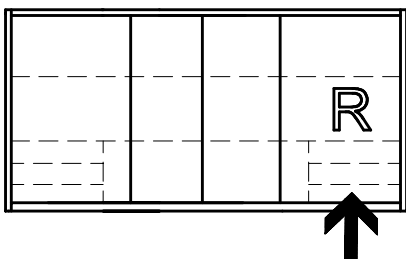
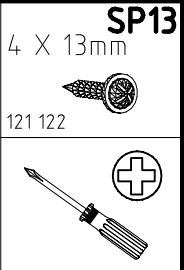
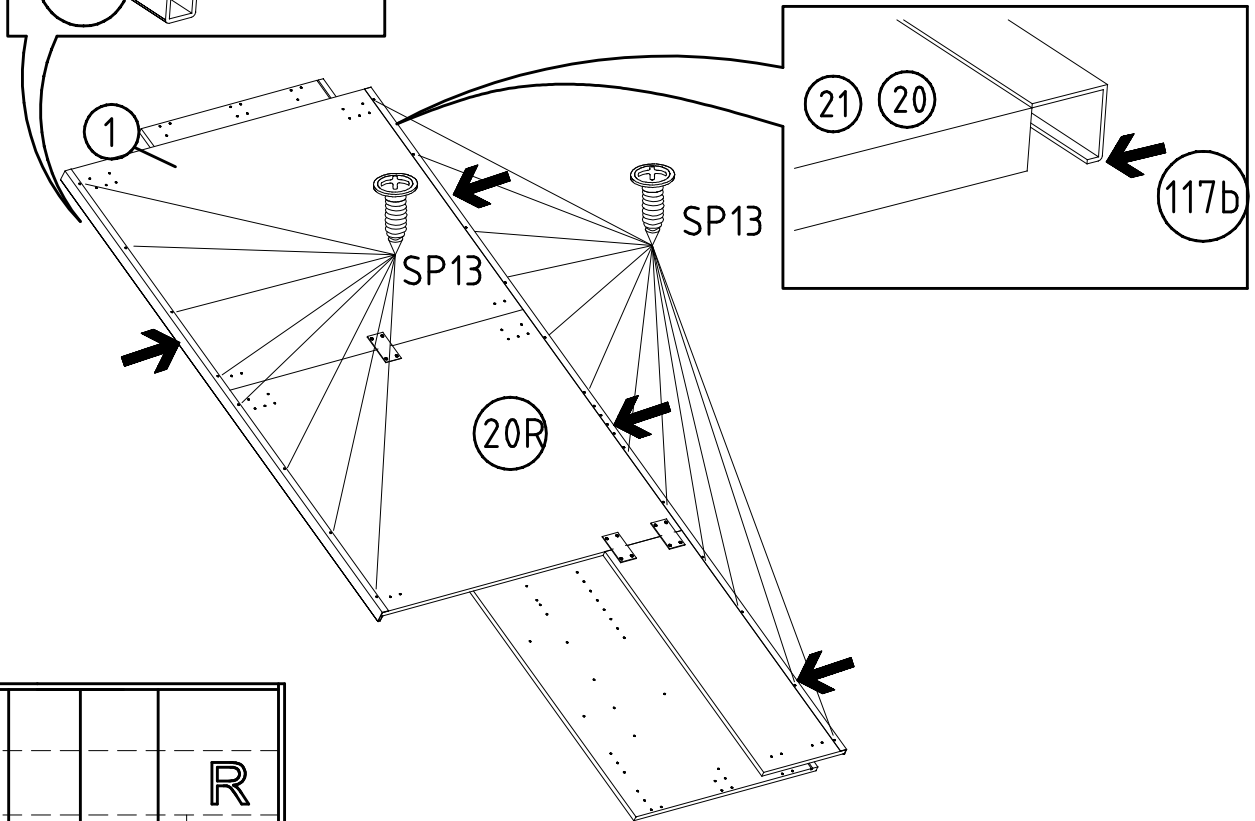
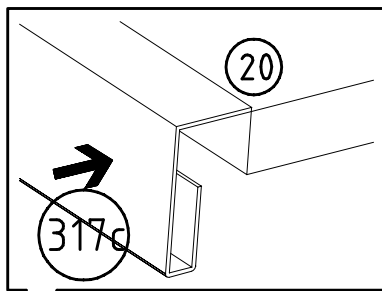

10

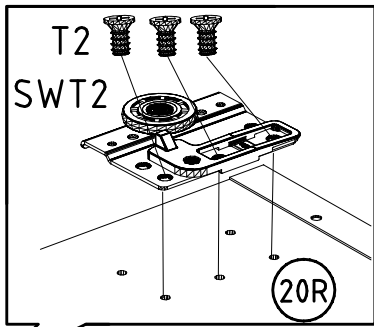
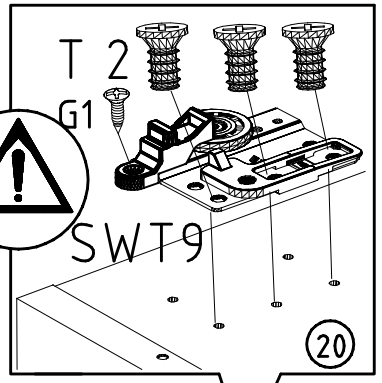

SWT2	SWT8
6,3 x 10,5 mm	T2
111 030	SWH 7
3,5 x 15 mm	G1
	4 X 13mm
121 370	
	121 122

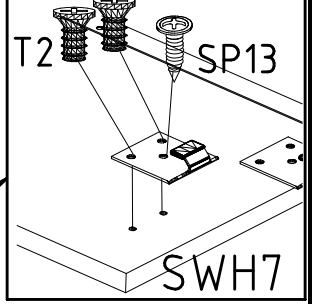
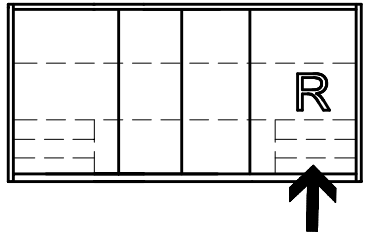
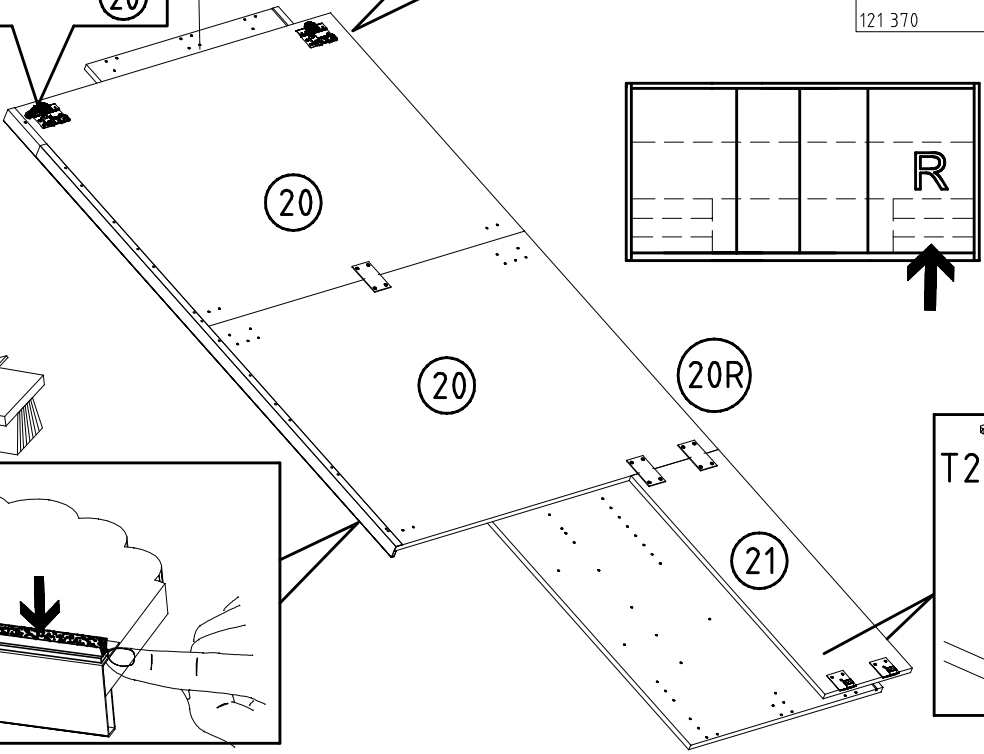
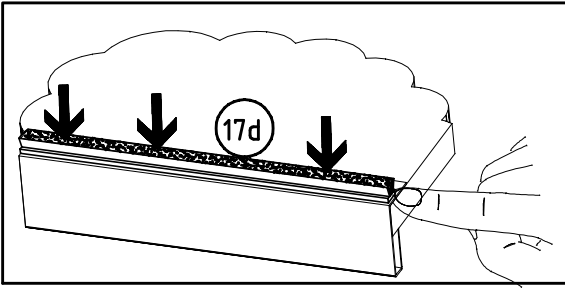
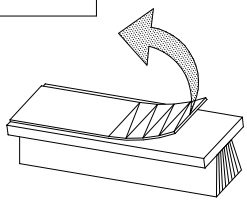
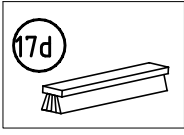
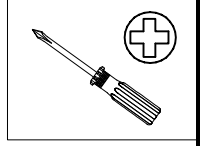

11

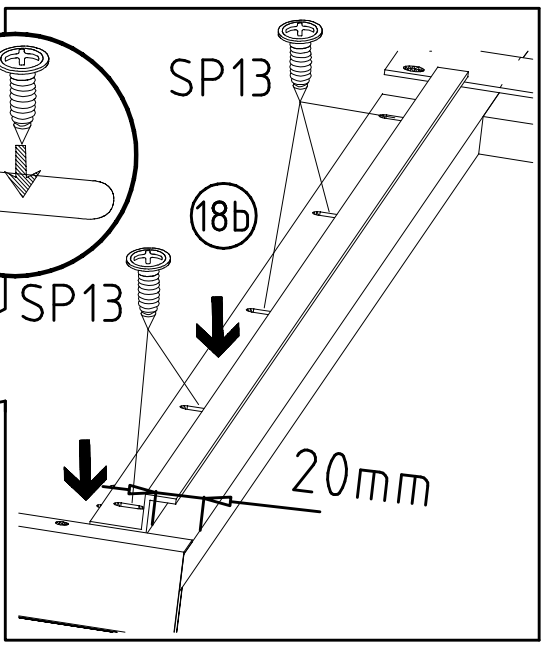
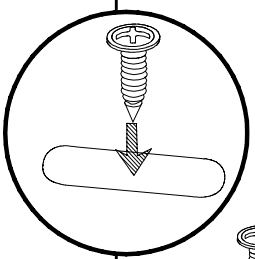
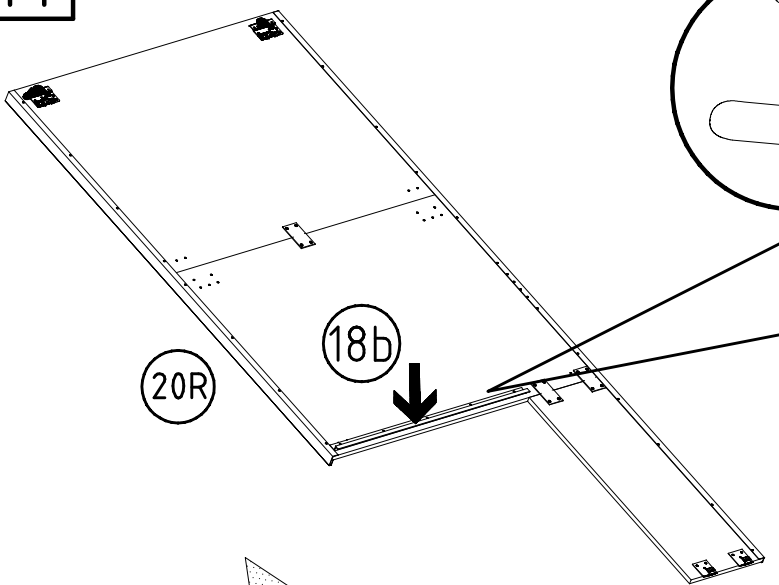

4 X 13mm
121 122

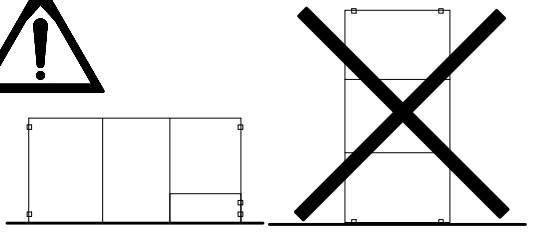
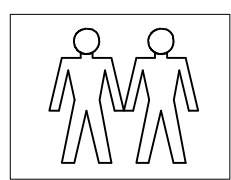
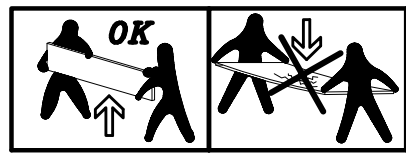
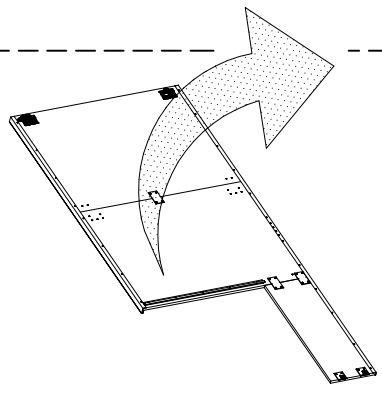

12

3,5 x 15 mm

G1

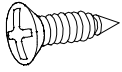

121 370

S0

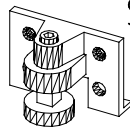

111 300

A1



111 xxx

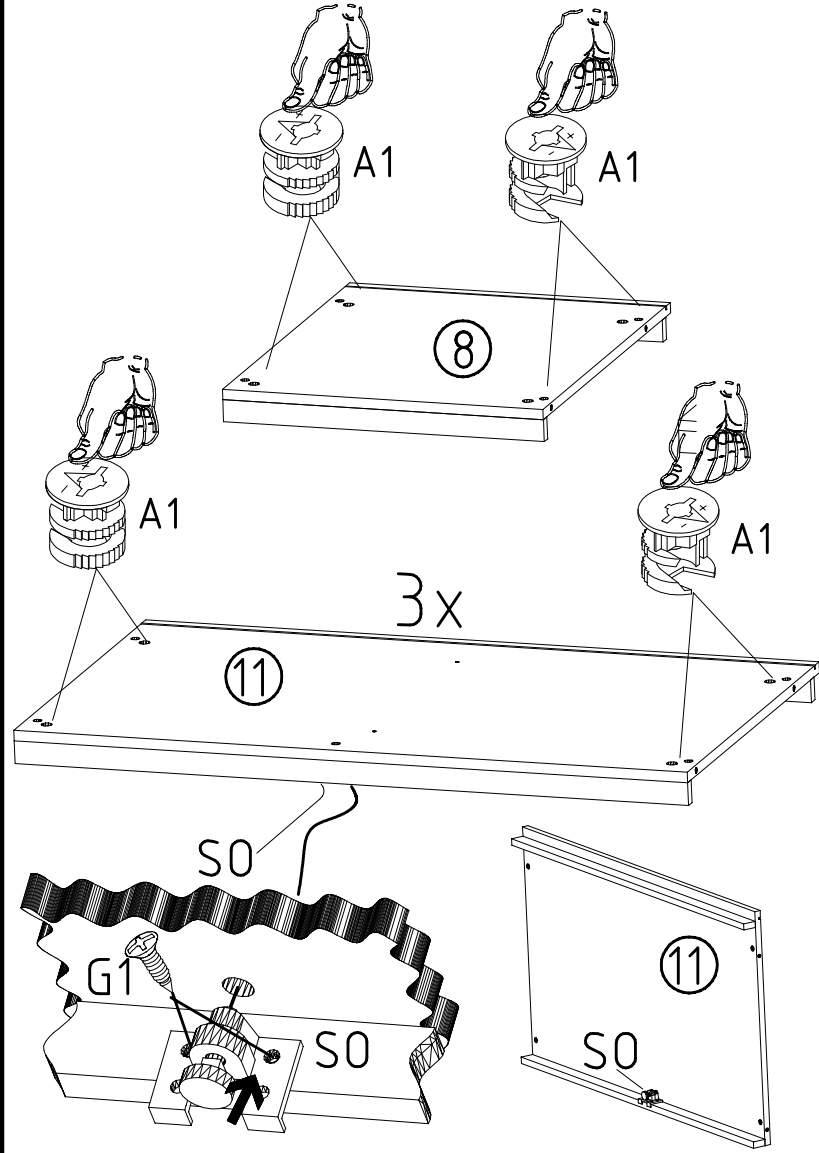

13

A1

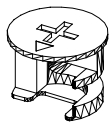

111 xxx

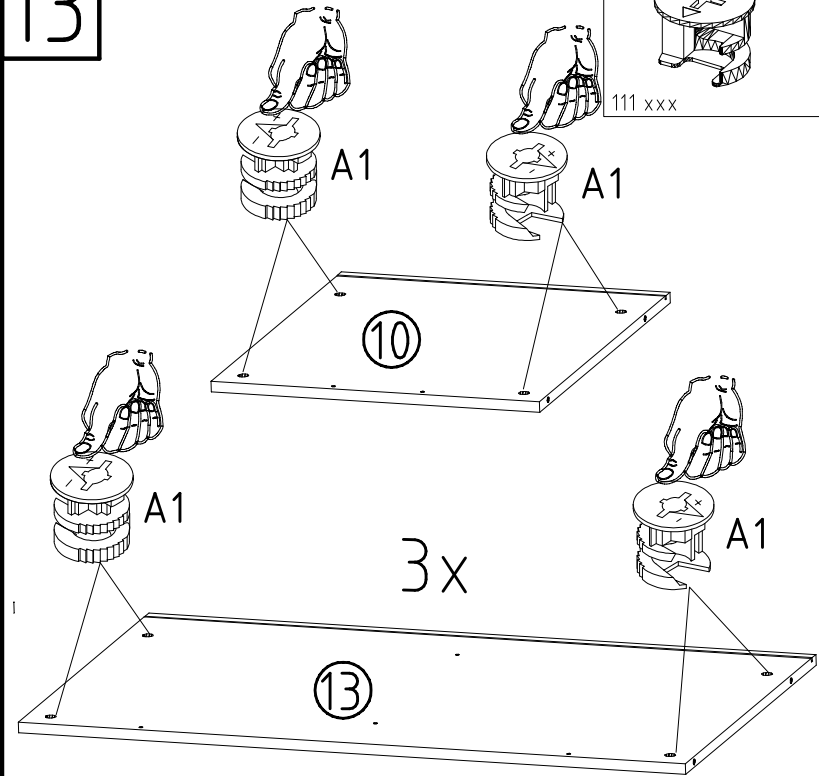

14

F3

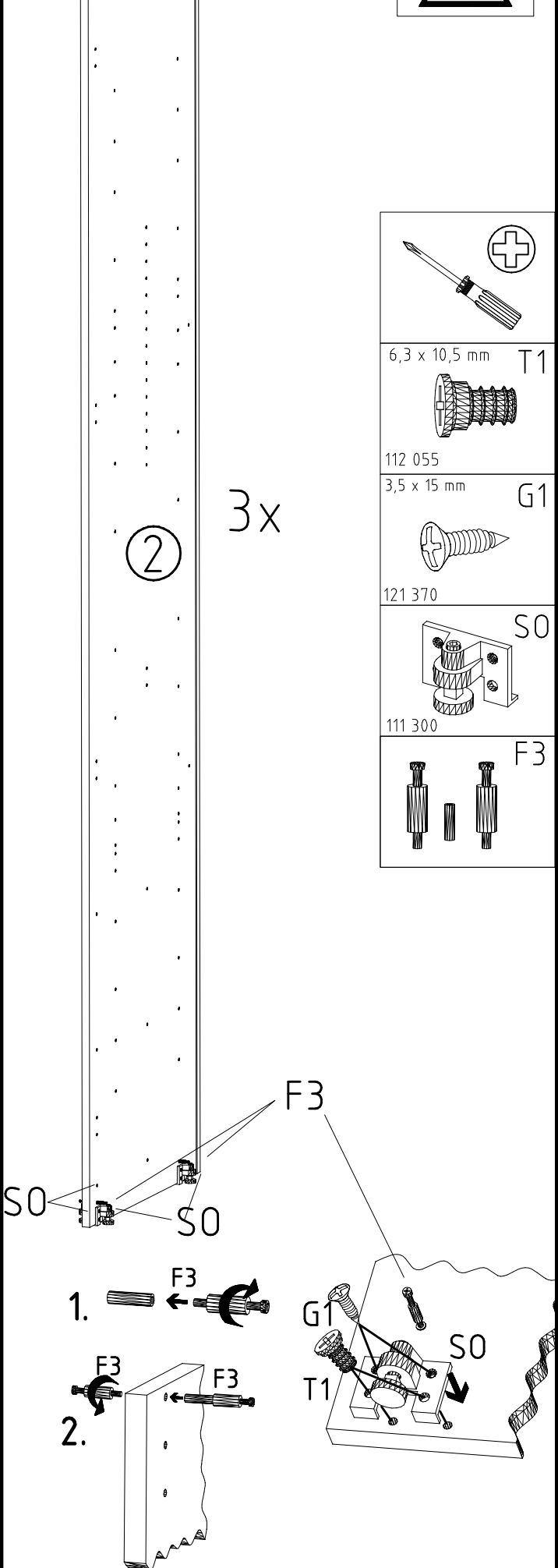

Parts list for step 14:

- Screwdriver (plus sign symbol)
- 6,3 x 10,5 mm T1
- 112 055
- 3,5 x 15 mm G1
- 121 370
- Bracket S0 (111 300)
- Bracket F3

SWH-SKL

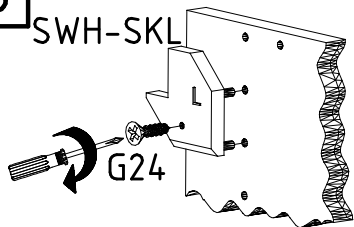

SWH-SKR

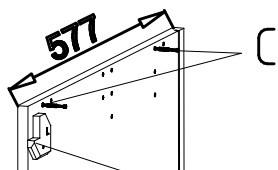
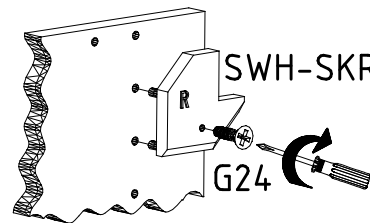

SWH-SKL +G24

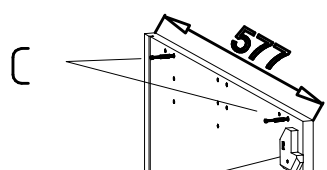
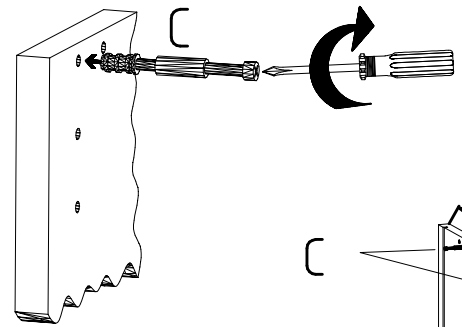

SWH-SKR +G24

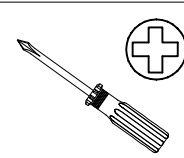
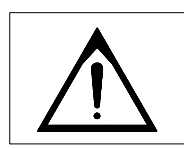

SWH-SKL

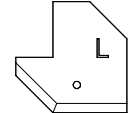

SWH-SKR

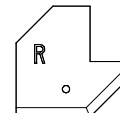

3,5 x 22 mm G24

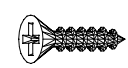

121 004

6,3 x 10,5 mm T1

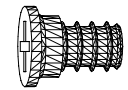

112 055

3,5 x 15 mm G1

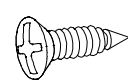

121 370

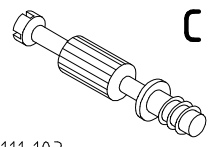

111 103

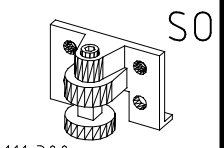

111 300

1

3

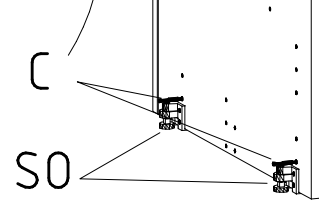
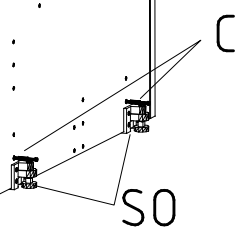
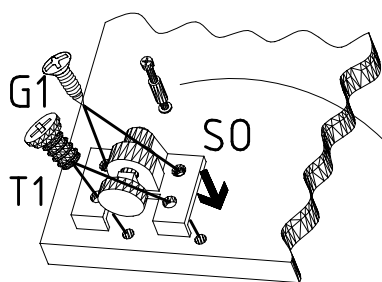

16

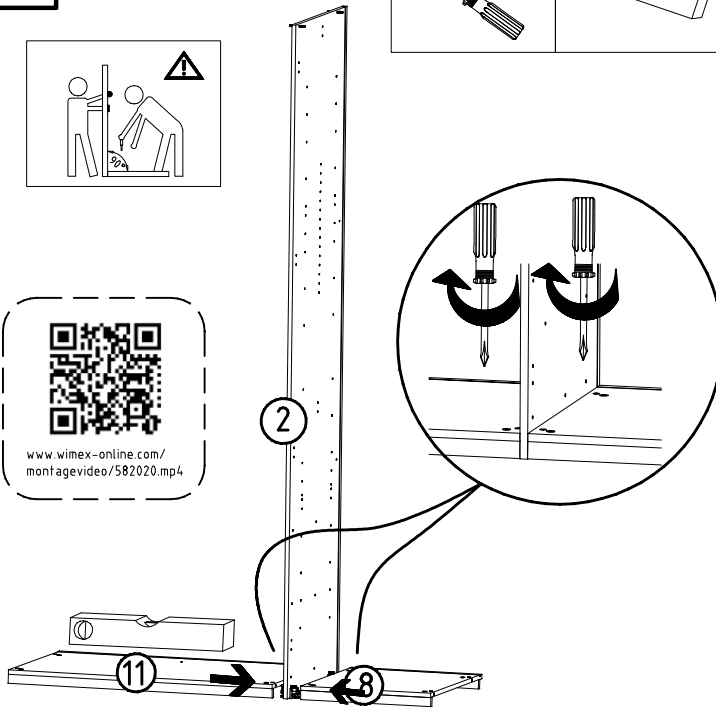
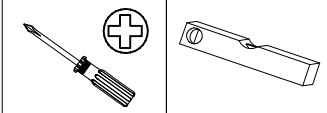

17

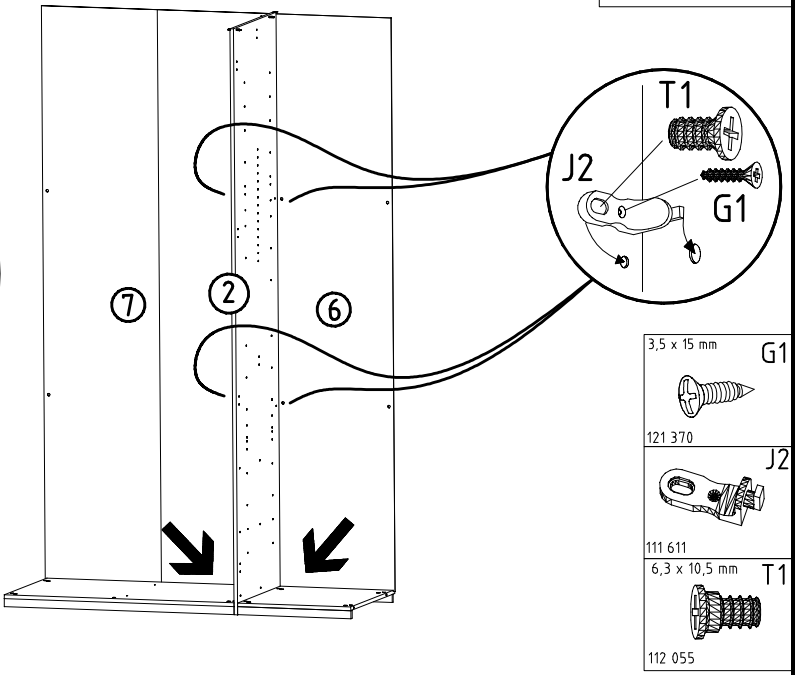
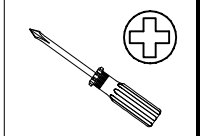

- 3,5 x 15 mm G1
- 121 370
- 111 611
- 6,3 x 10,5 mm T1
- 112 055

18

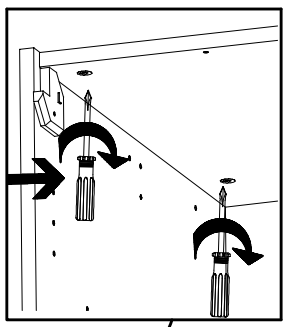

- 3,5 x 15 mm G1
- 121 370
- 6,3 x 10,5 mm T1
- 112 055
- 111 611

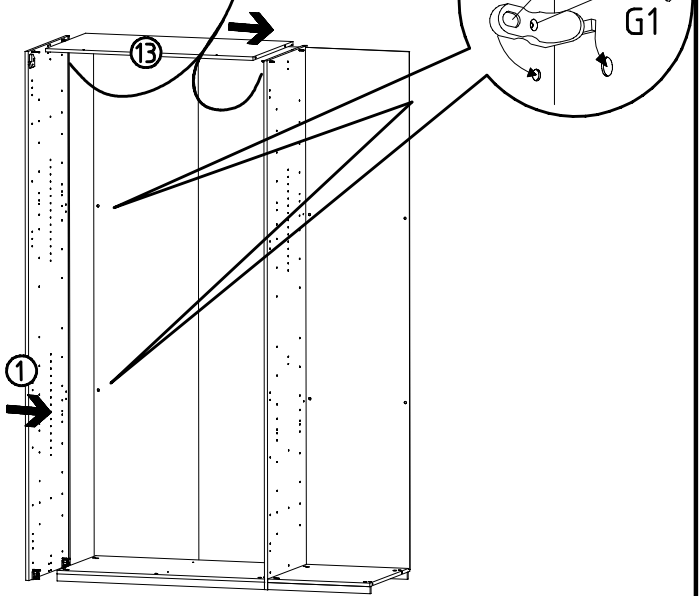

19

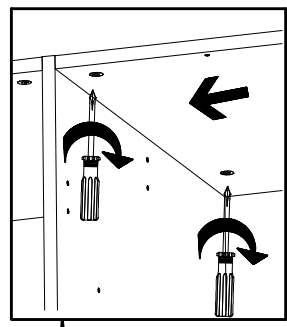

- 3,5 x 15 mm G1
- 121 370
- 6,3 x 10,5 mm T1
- 112 055
- 111 611

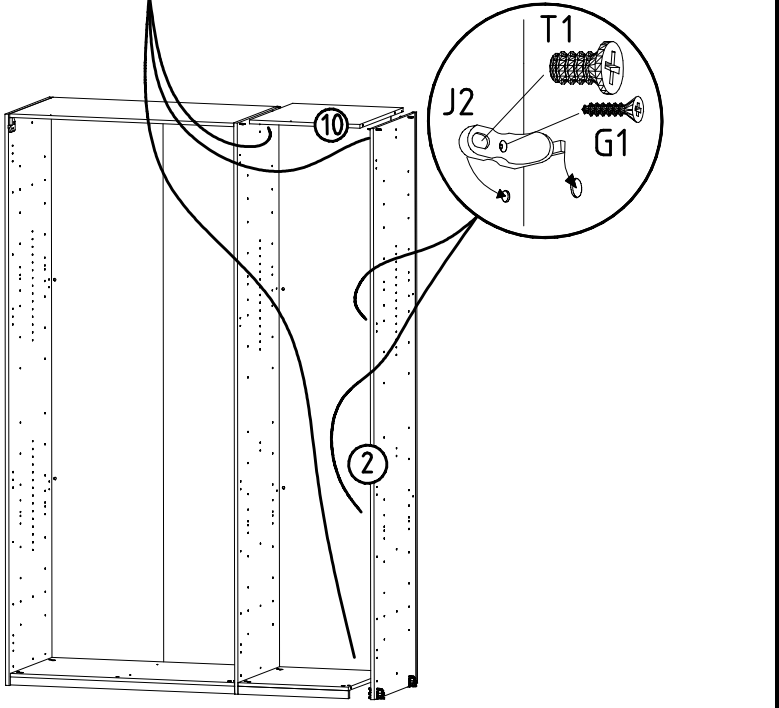

20

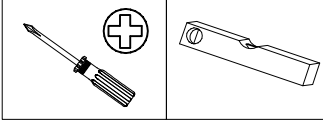
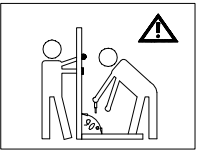

21

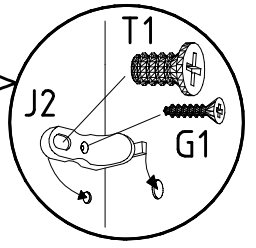
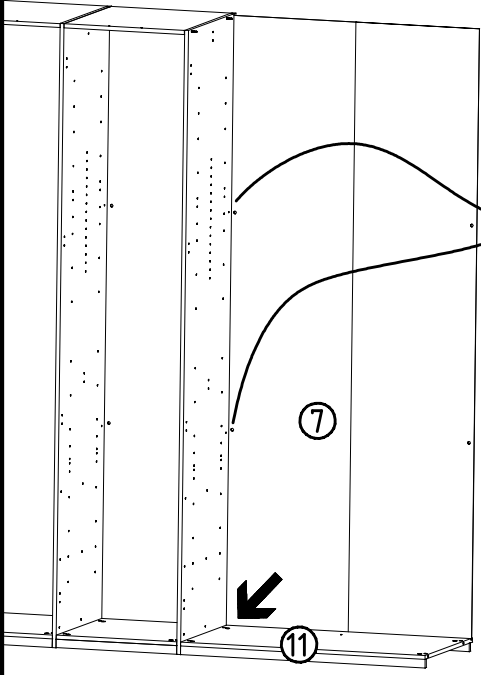
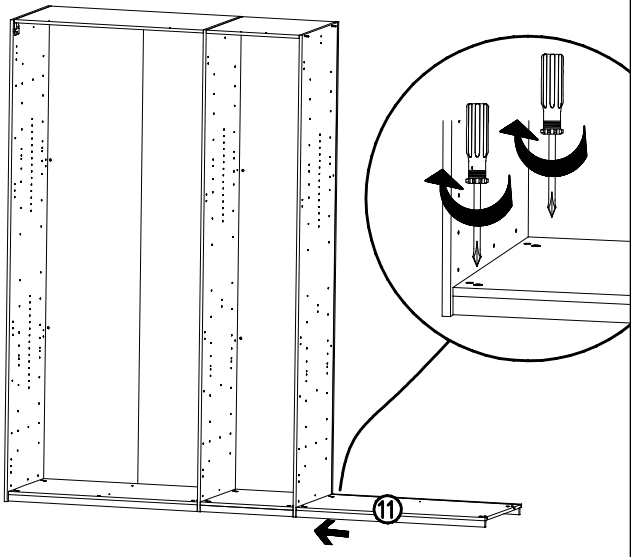
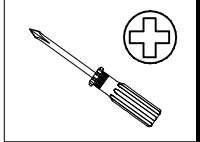

- 3,5 x 15 mm G1
- 121 370 J2
- 111 611 6,3 x 10,5 mm T1
- 112 055

22

- 3,5 x 15 mm G1
- 121 370 J2
- 111 611 6,3 x 10,5 mm T1
- 112 055

23

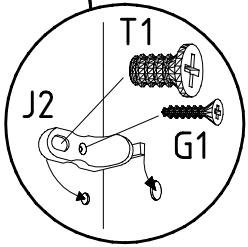
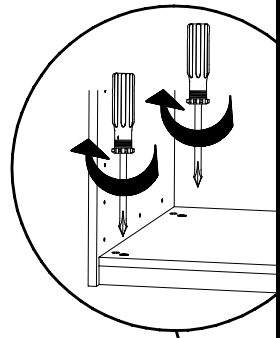
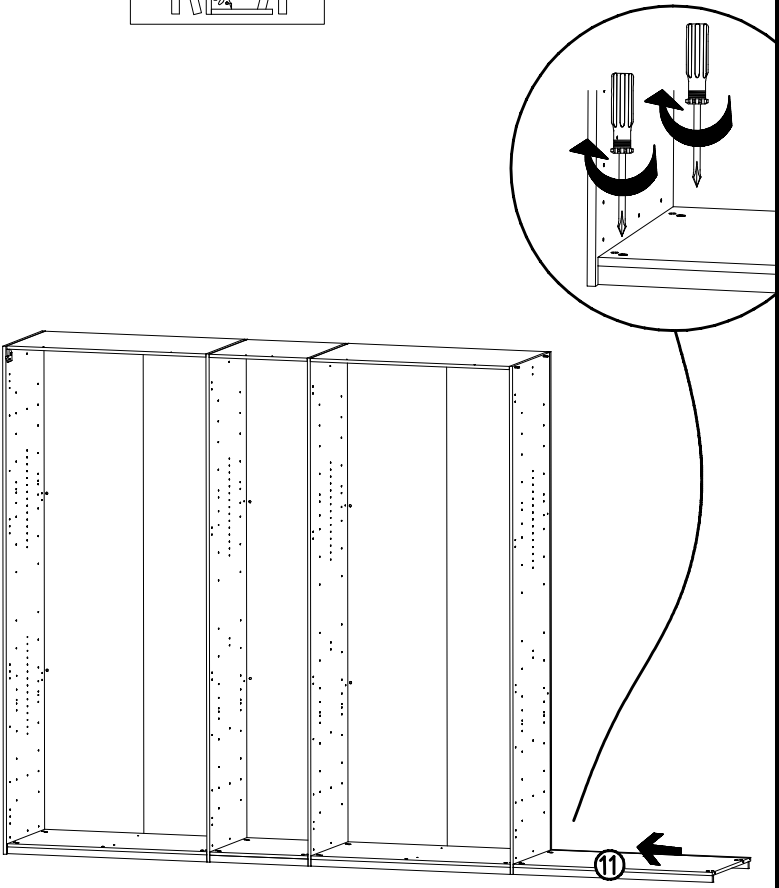
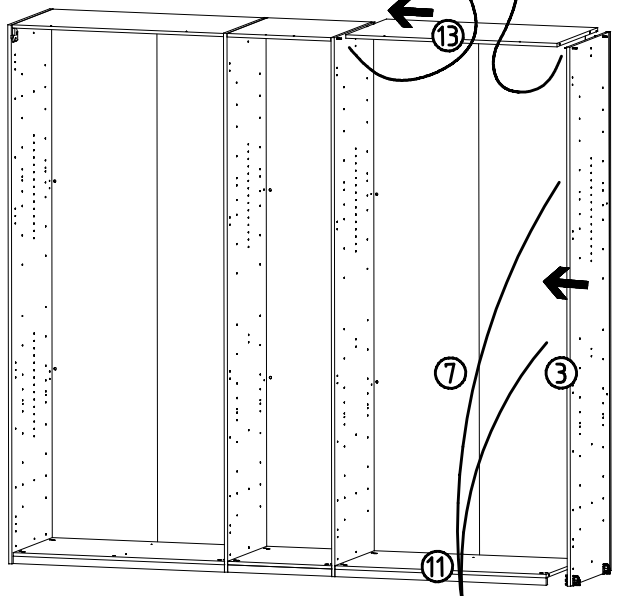
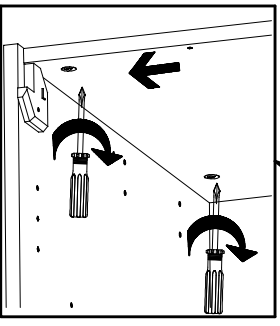
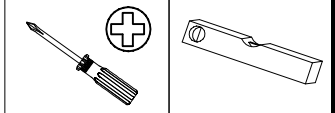

24

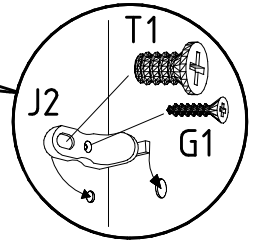
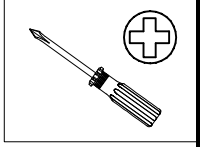
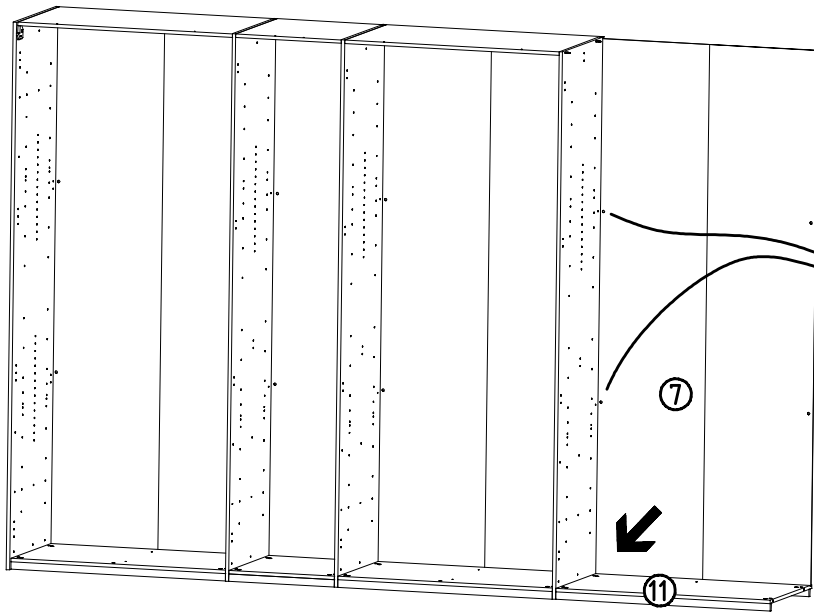

- 3,5 x 15 mm G1
- 121 370
- J2
- 111 611
- 6,3 x 10,5 mm T1
- 112 055

25

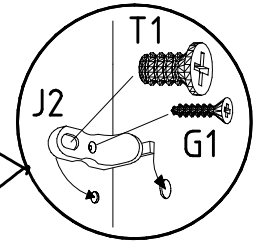
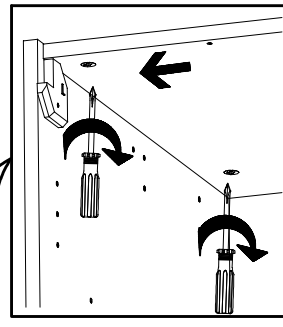
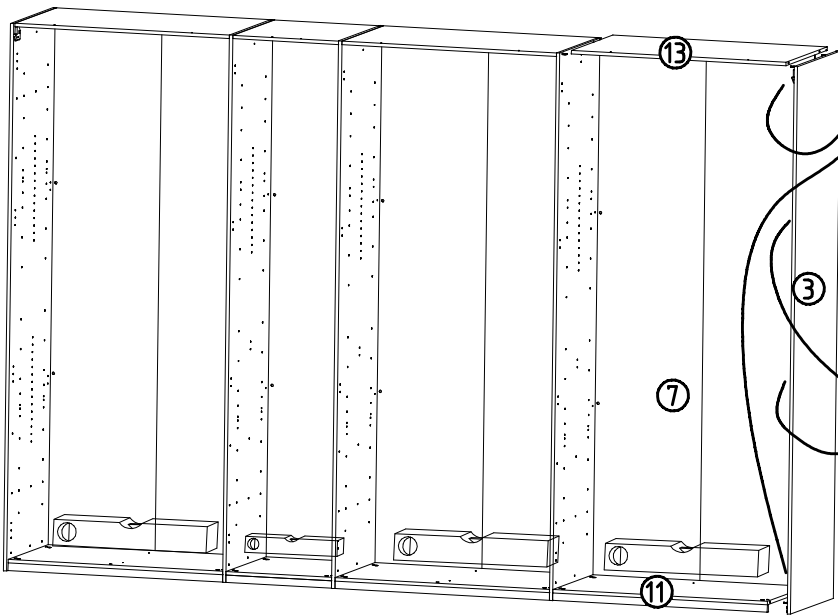

- 3,5 x 15 mm G1
- 121 370
- J2
- 111 611
- 6,3 x 10,5 mm T1
- 112 055

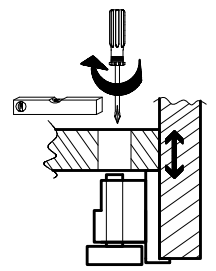

26

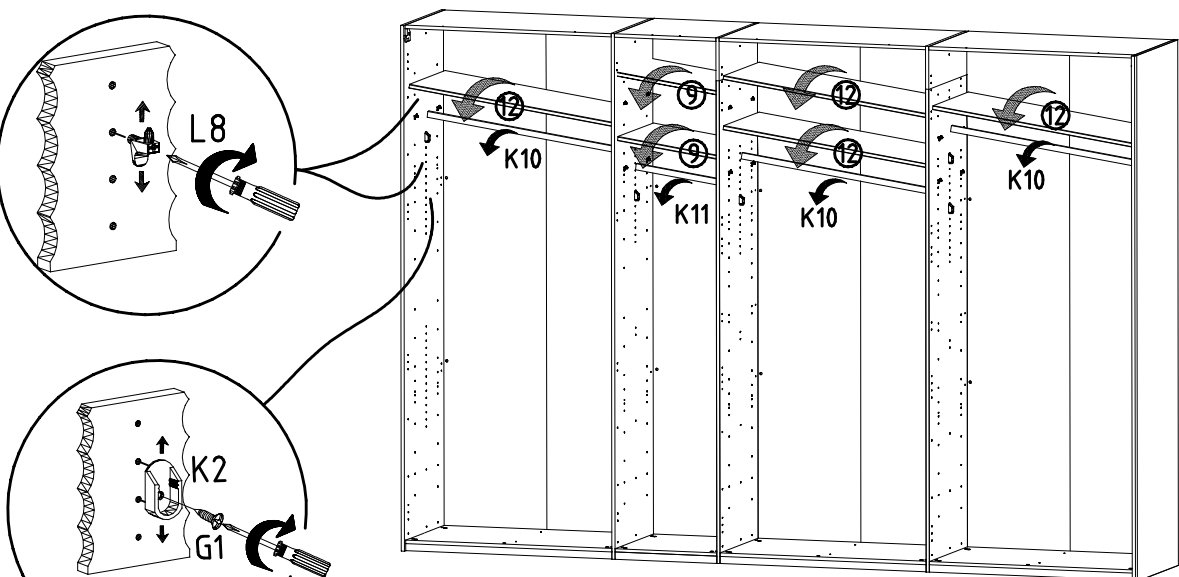

- L8
- 111 607
- K2
- 117 002
- 3,5 x 15 mm G1
- 121 370
- K10
- 100cm
- 112 400
- K11
- 50cm
- 112 401

27

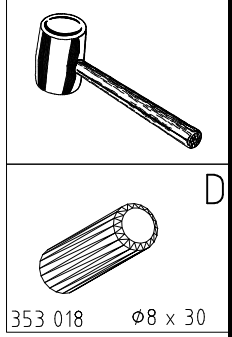
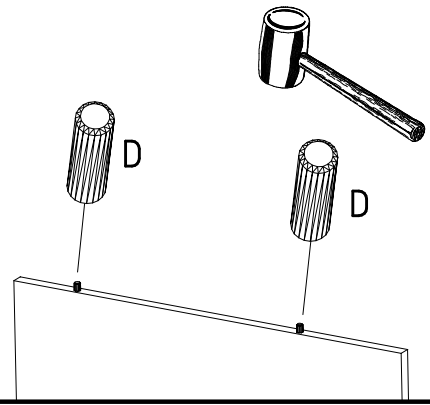
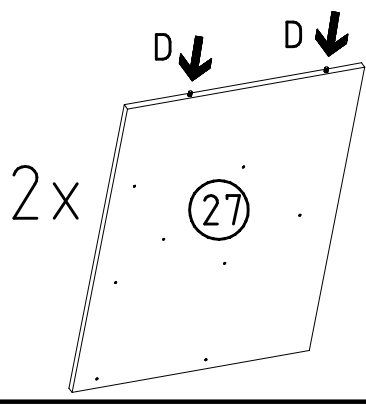

28

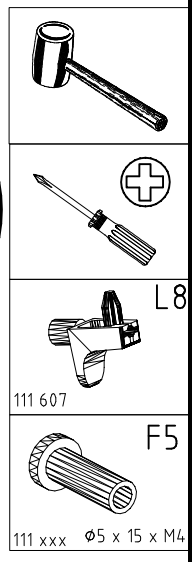
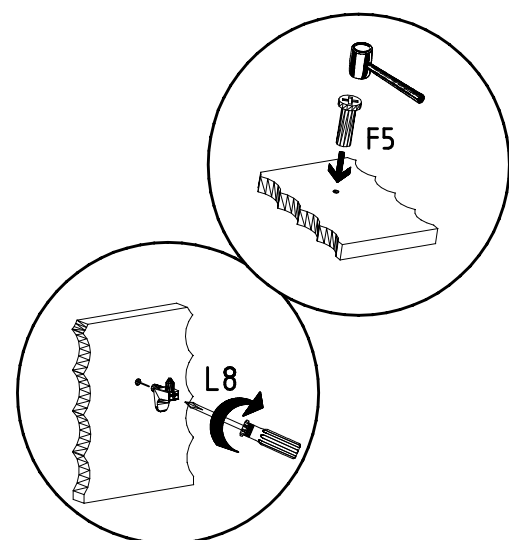
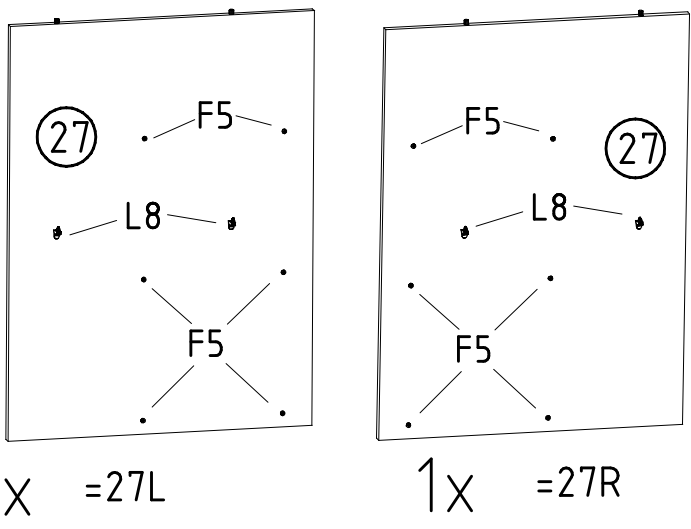

29

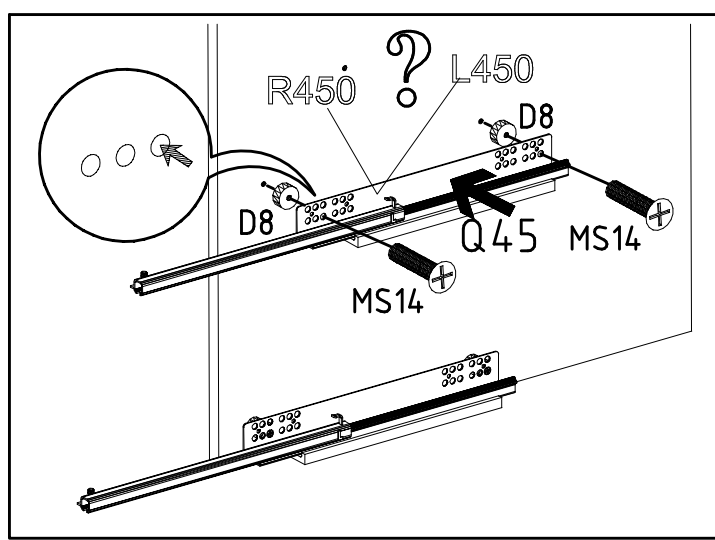
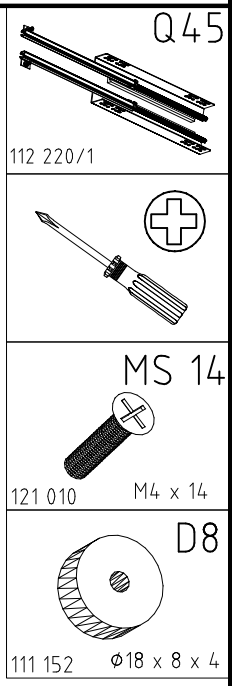
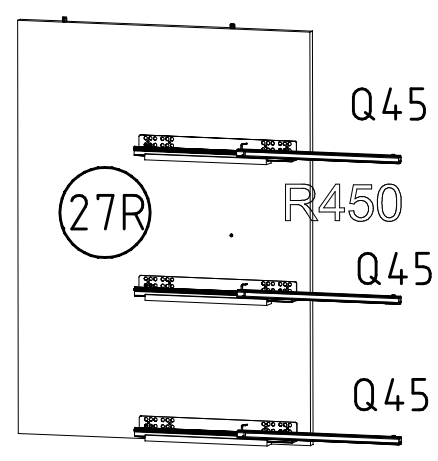
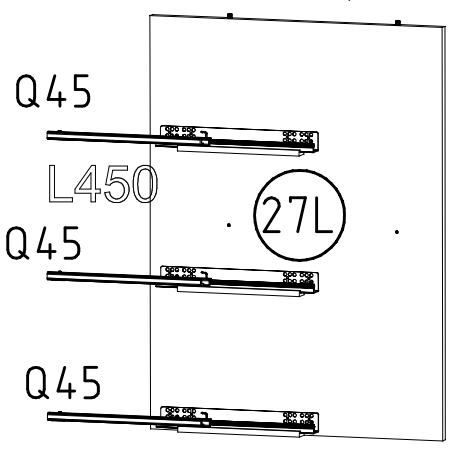
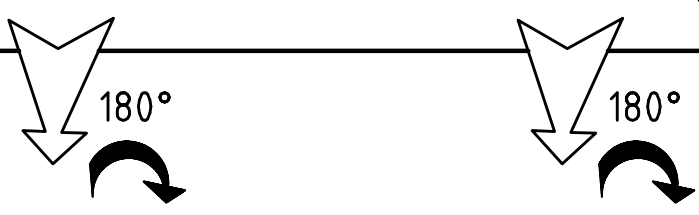

32

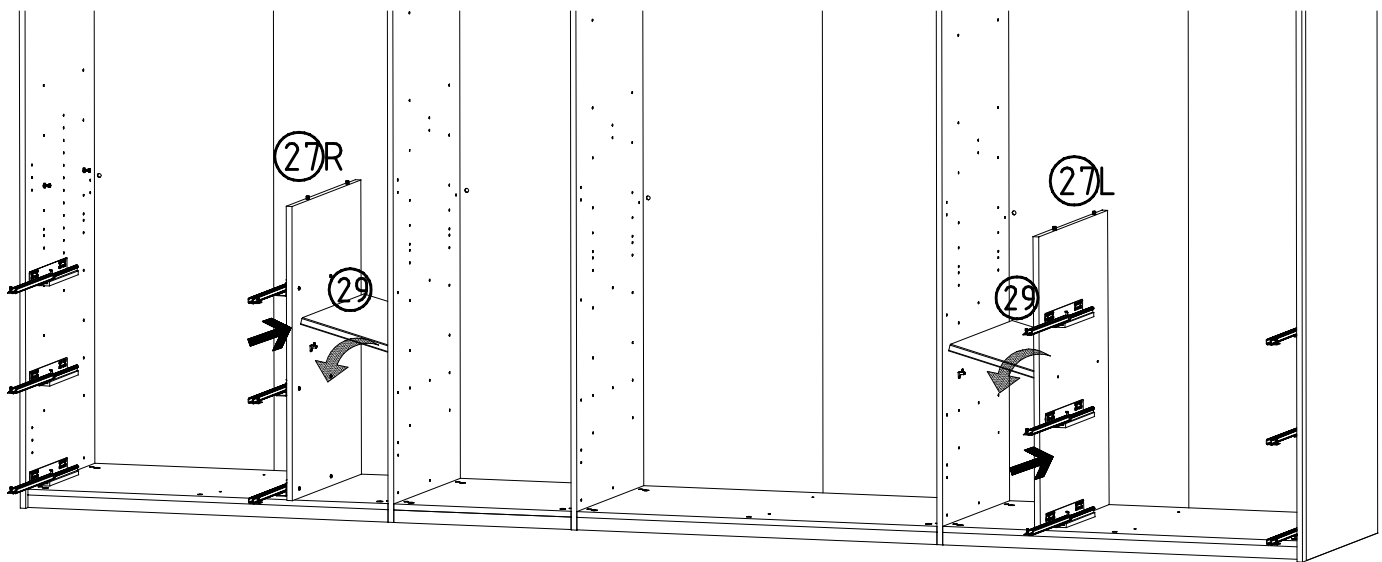

33

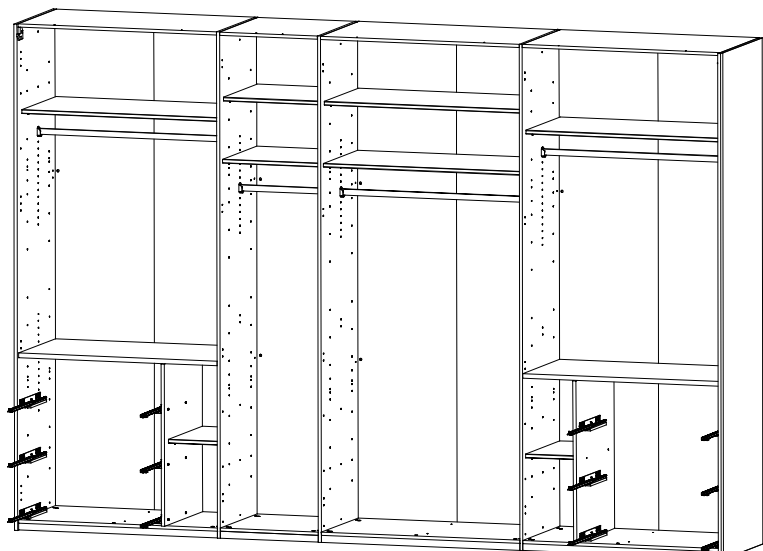
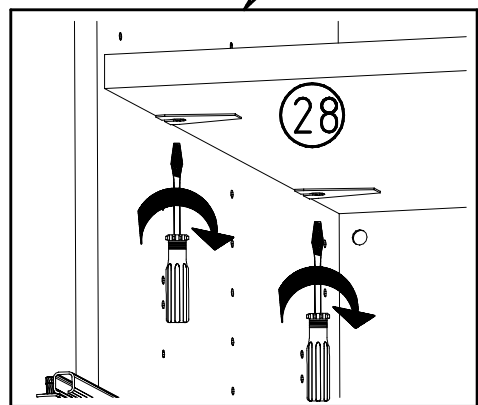
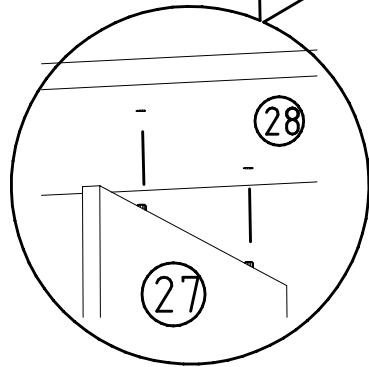
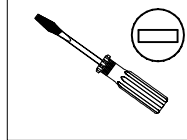
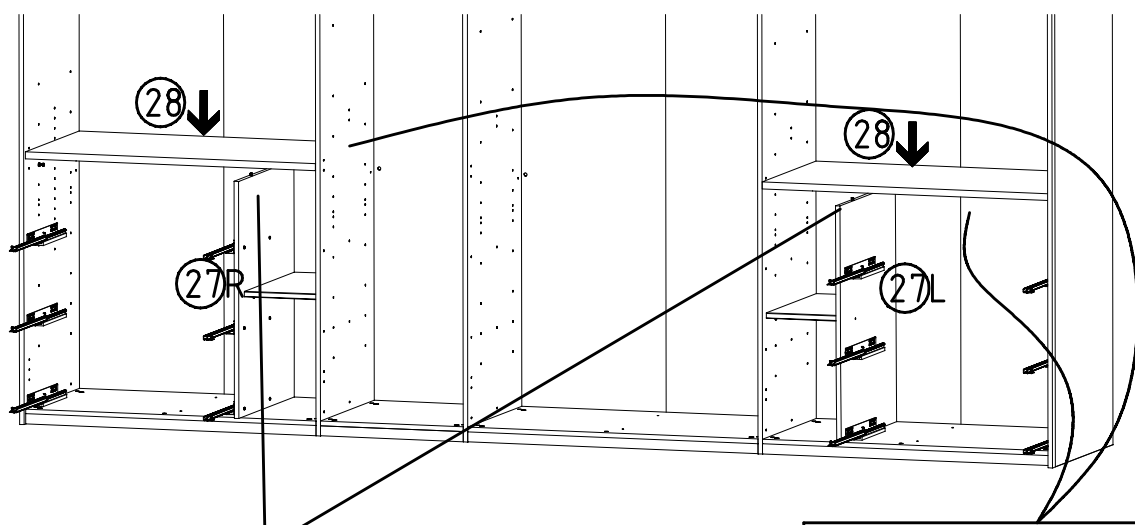

34

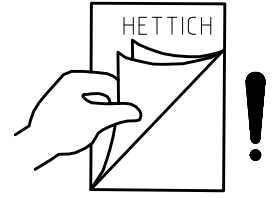
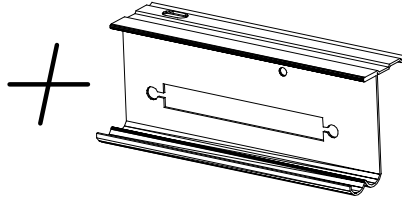
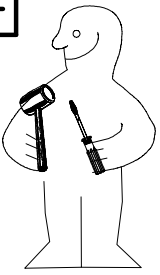

35

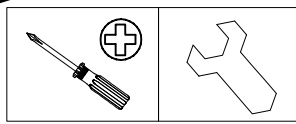
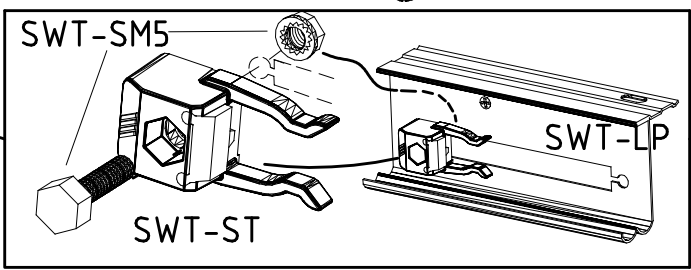
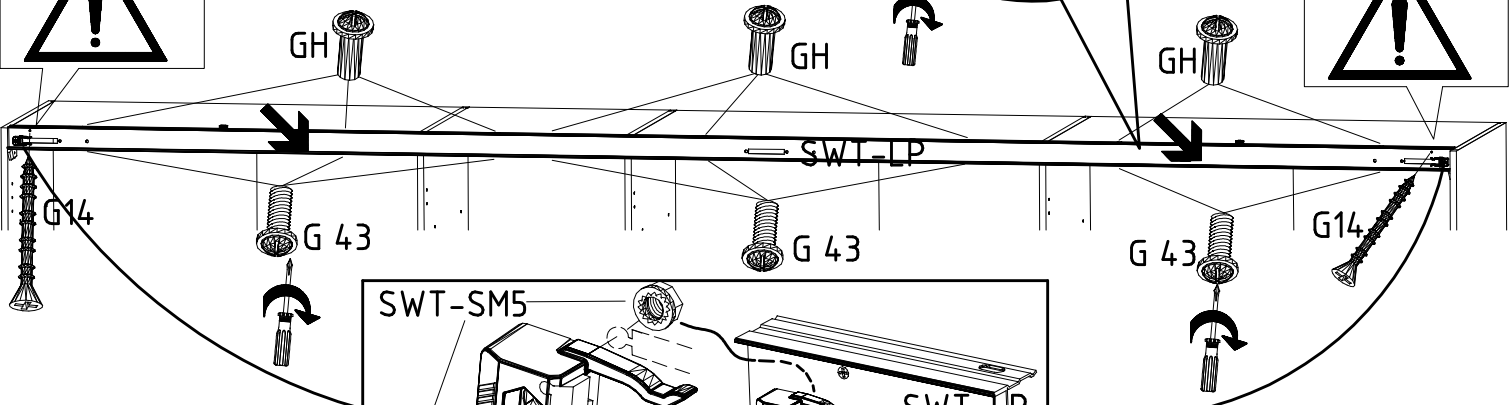
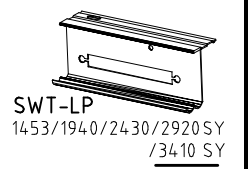
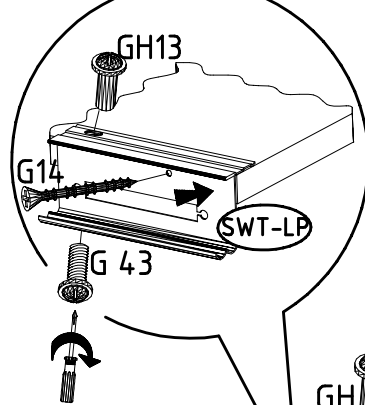
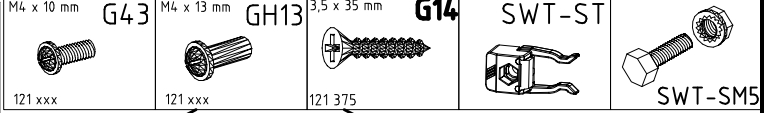
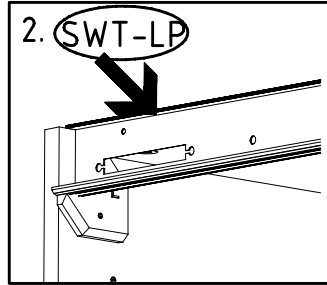
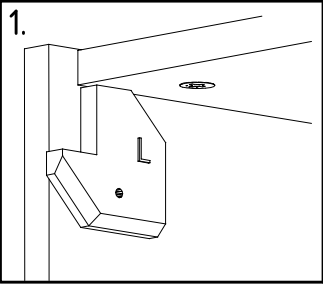

36

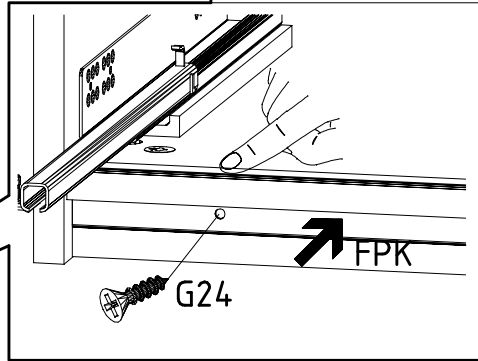
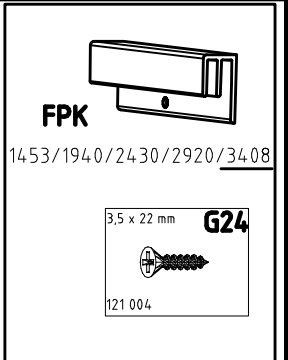
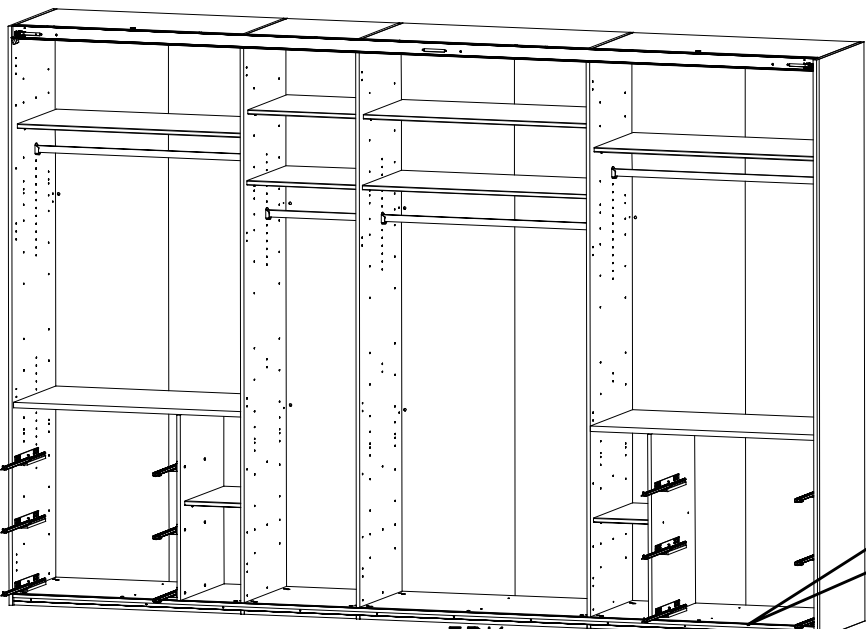

37

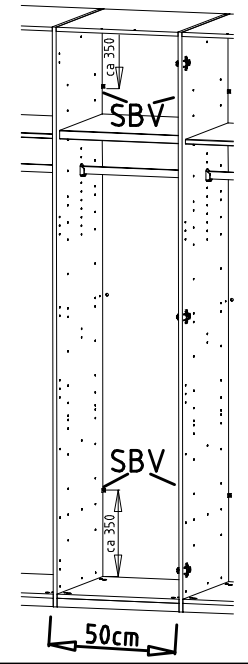
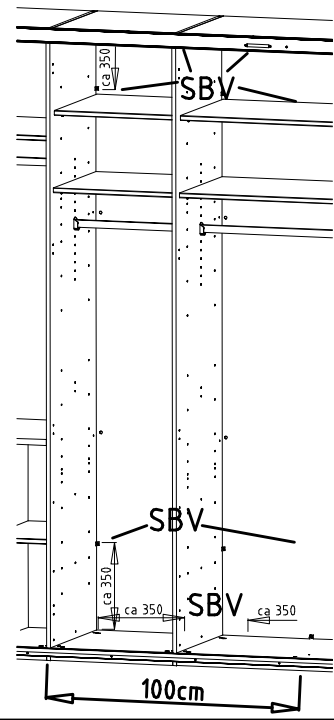
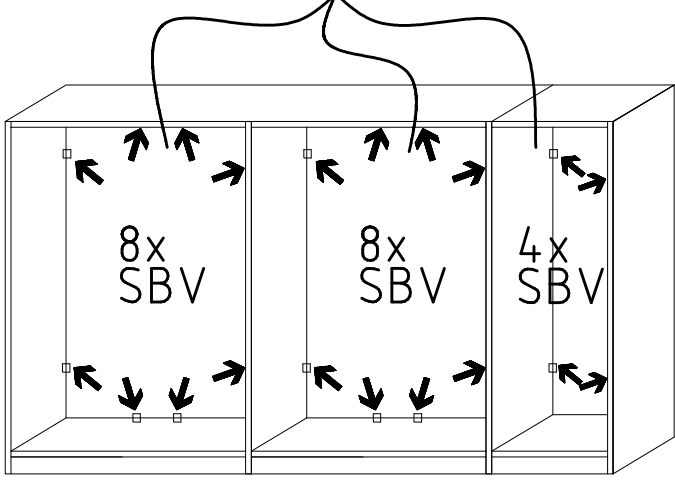
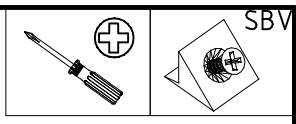
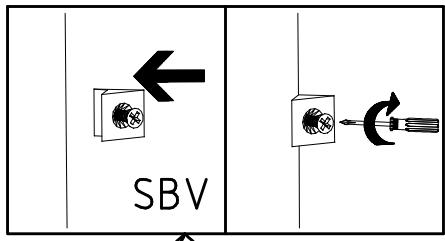

38

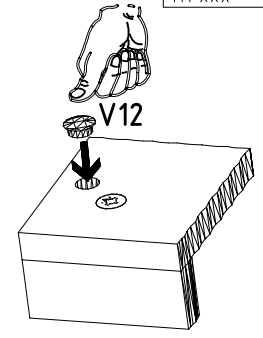
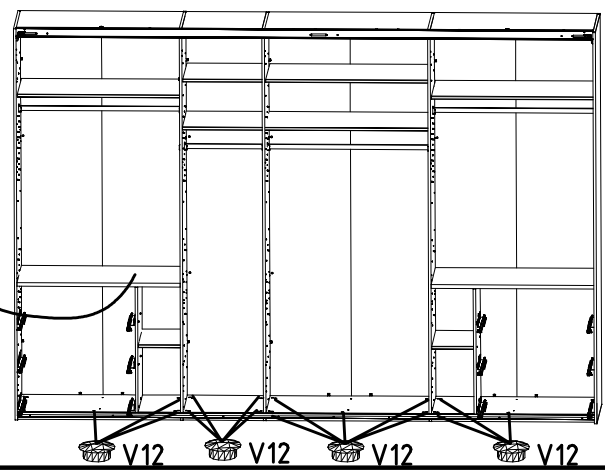
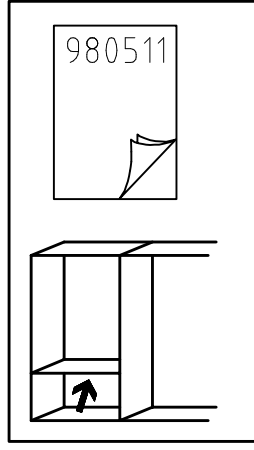

39

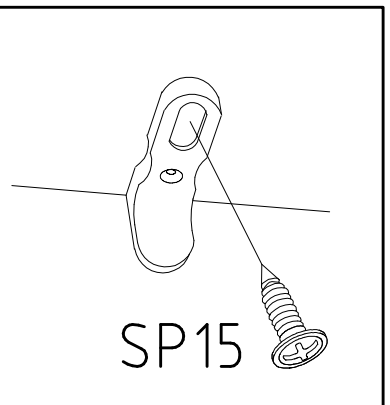
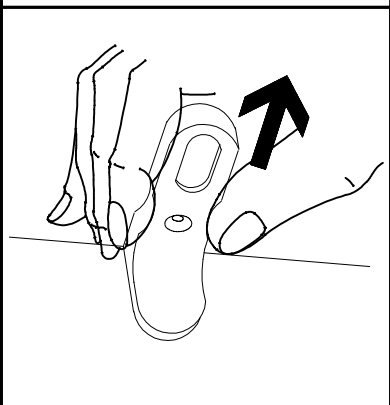
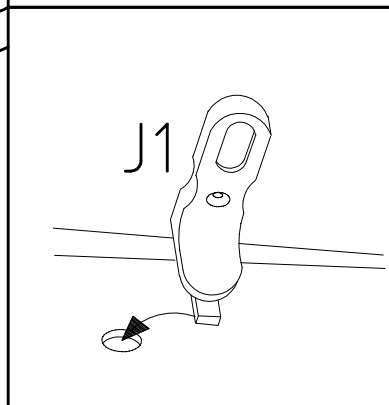
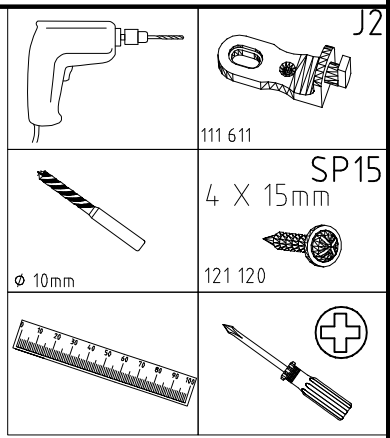
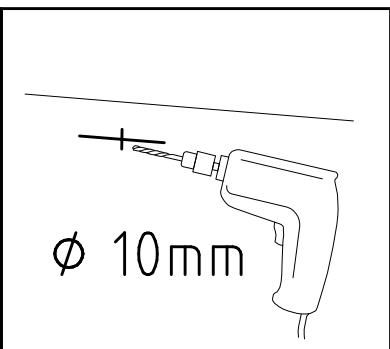
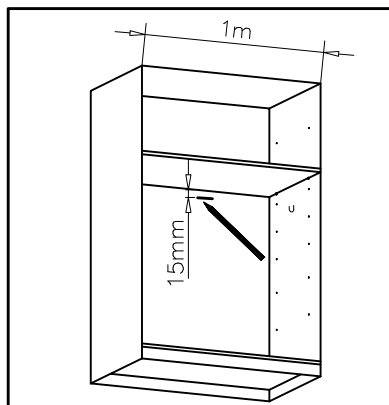
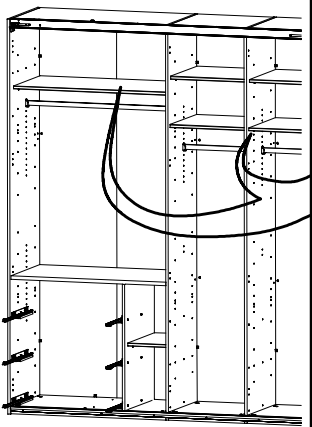

40

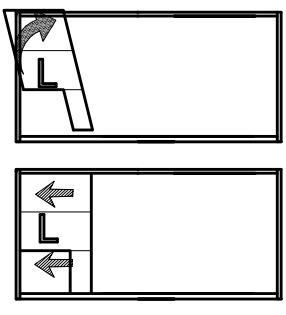

41

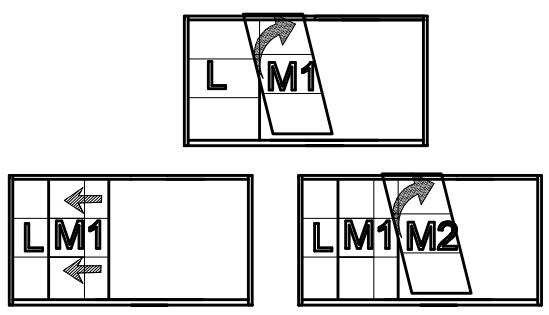

42

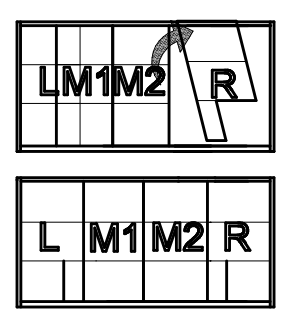

40 + 42

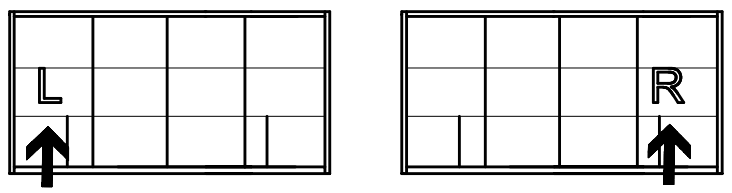

41

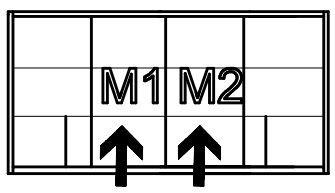

I.

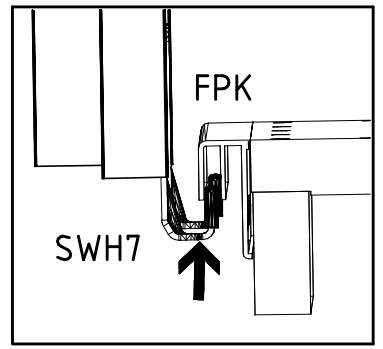

I.

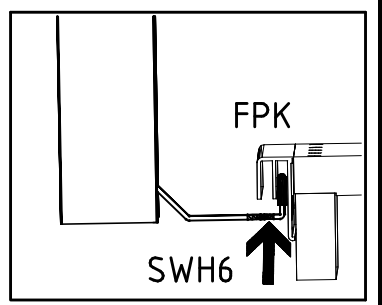

II.

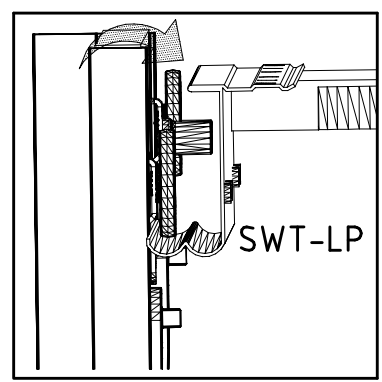

II.

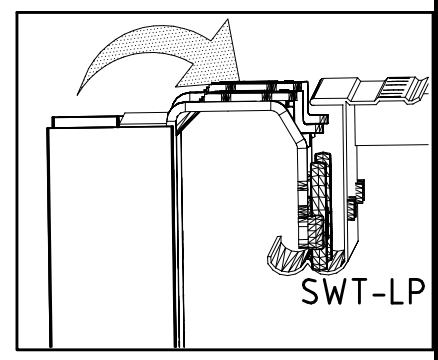

III.

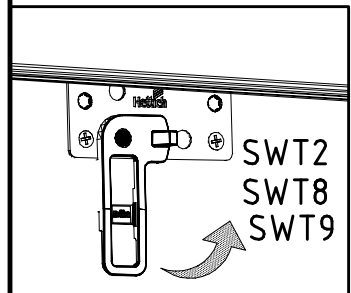

III.

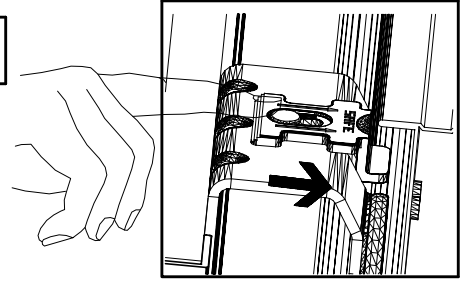
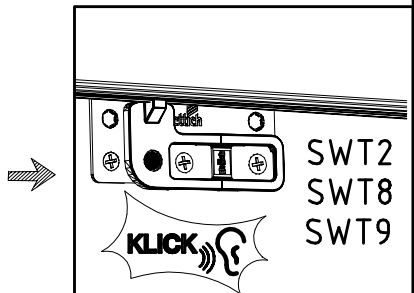

46

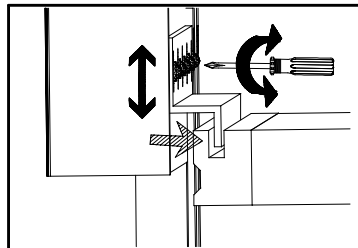
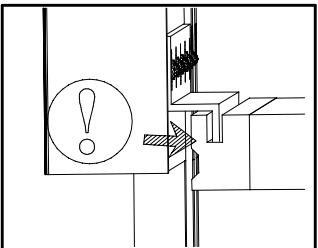
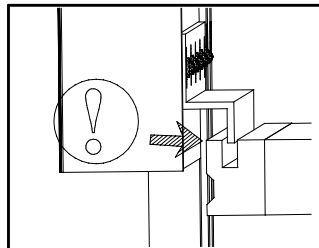
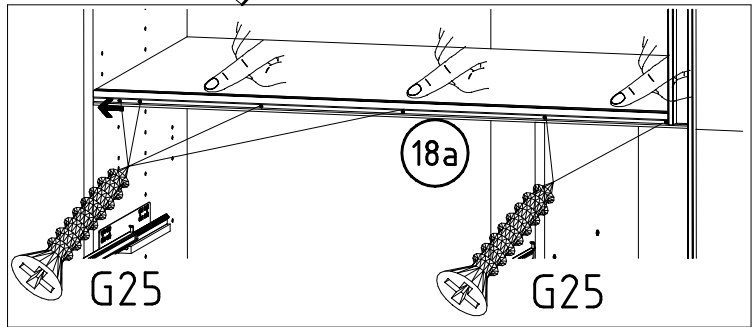
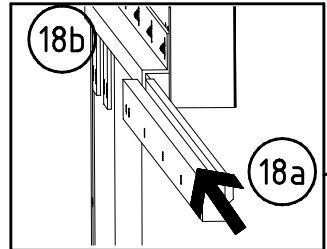
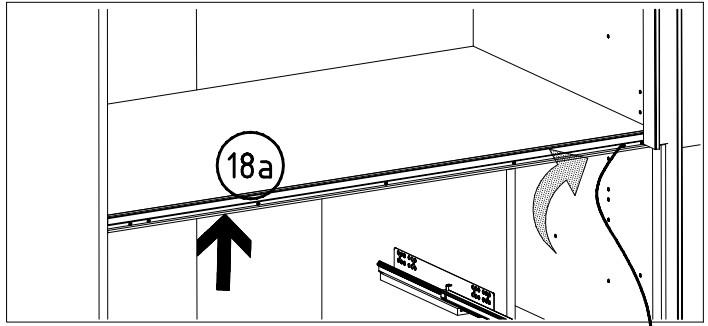
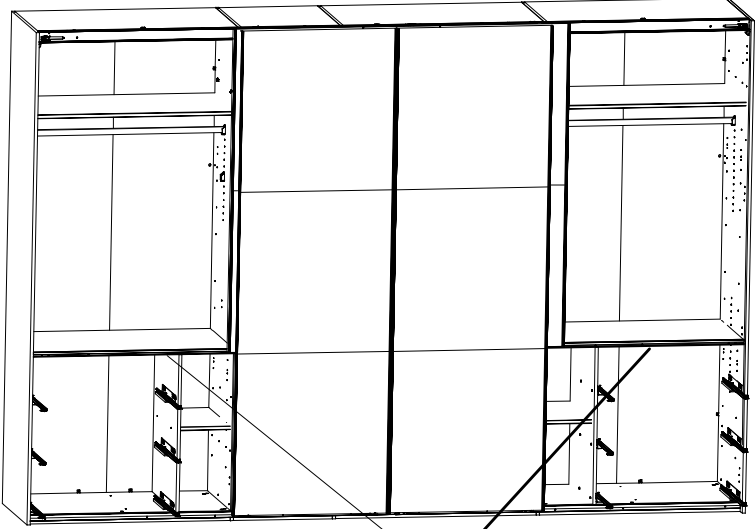
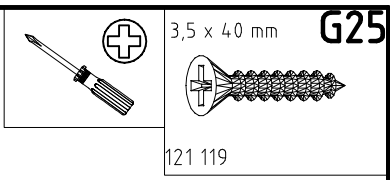

47

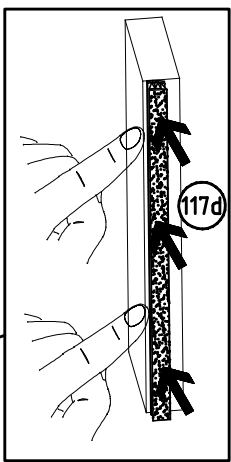
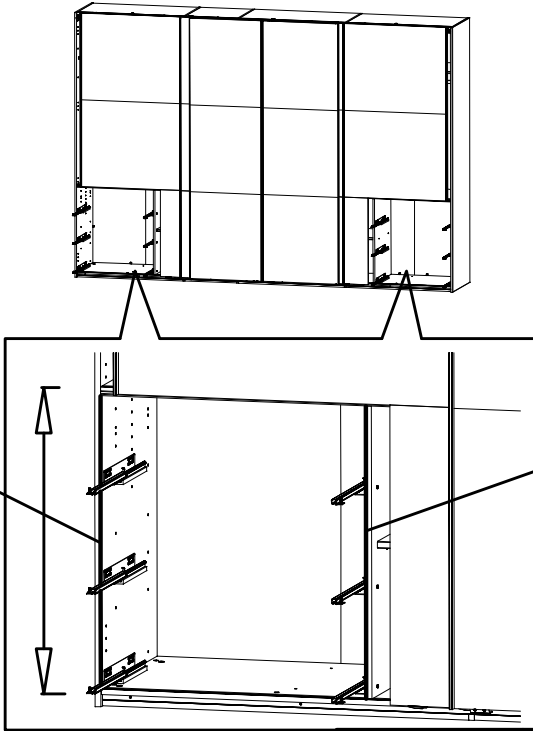
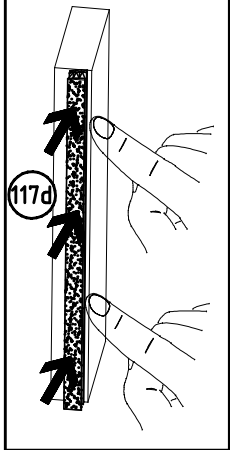
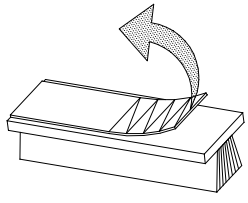
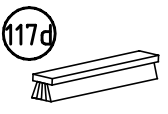

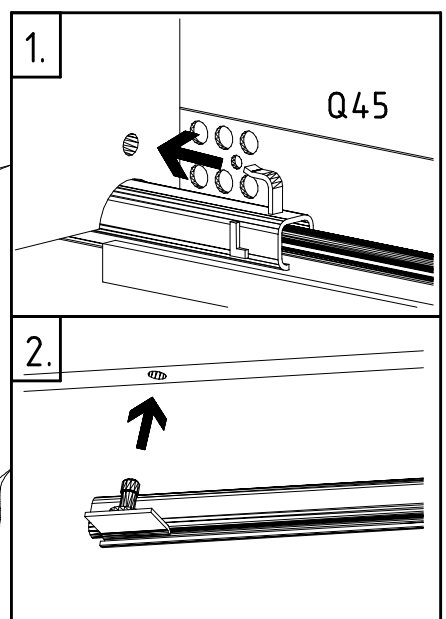
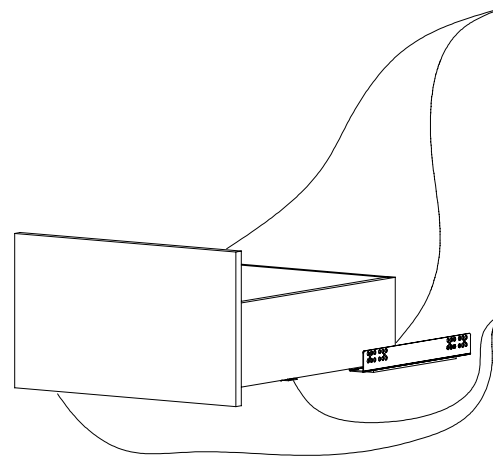
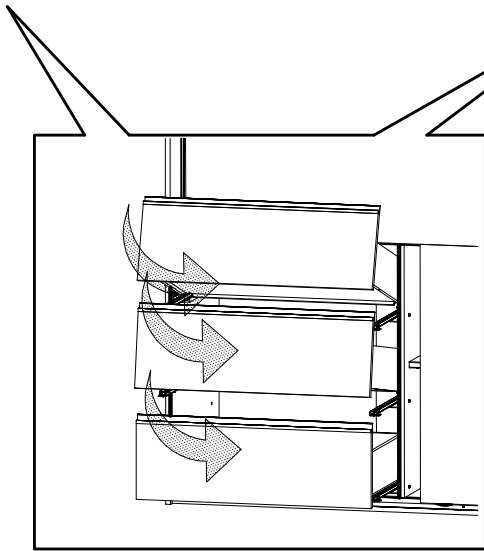
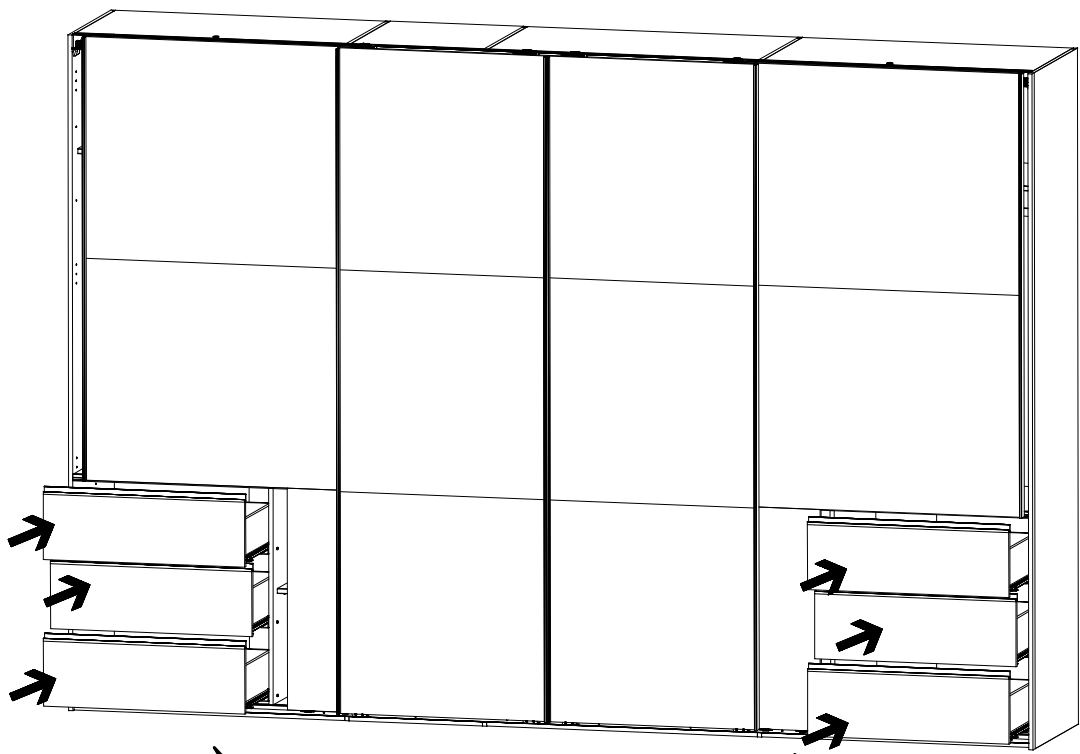

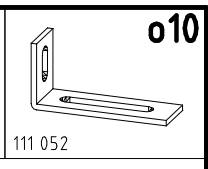
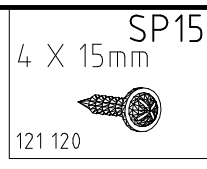
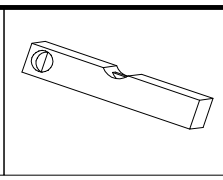
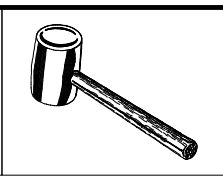
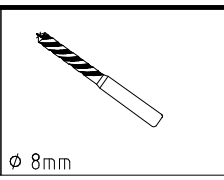
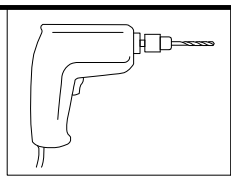

121 120

111 052

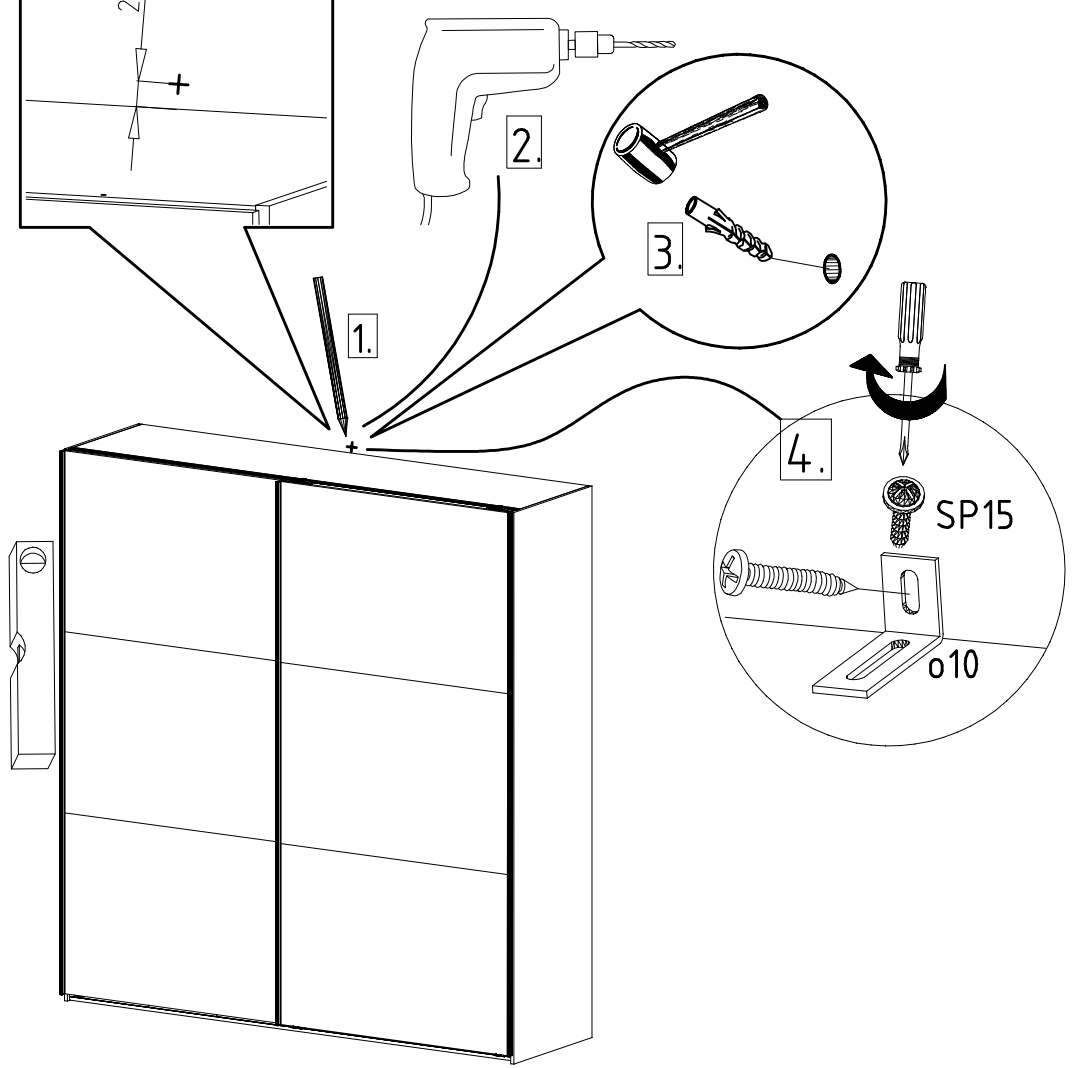
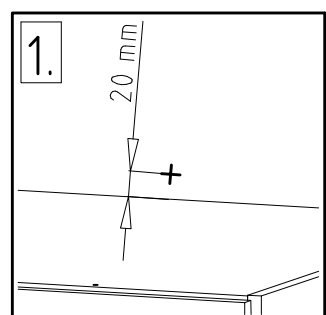
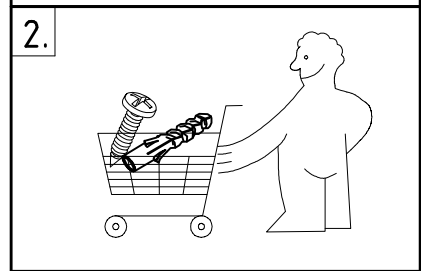
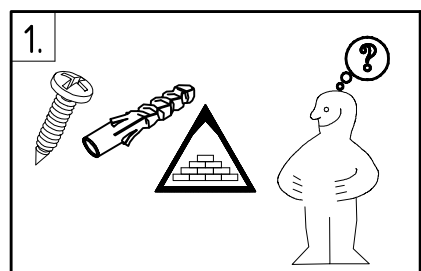



352 302

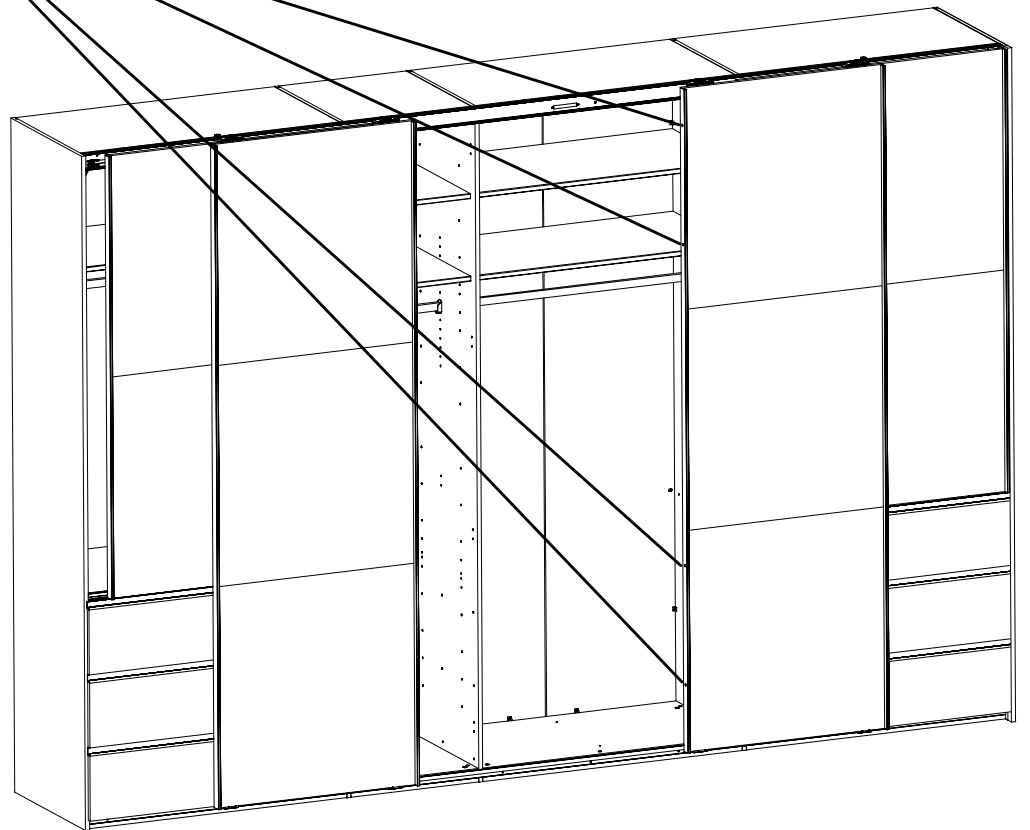
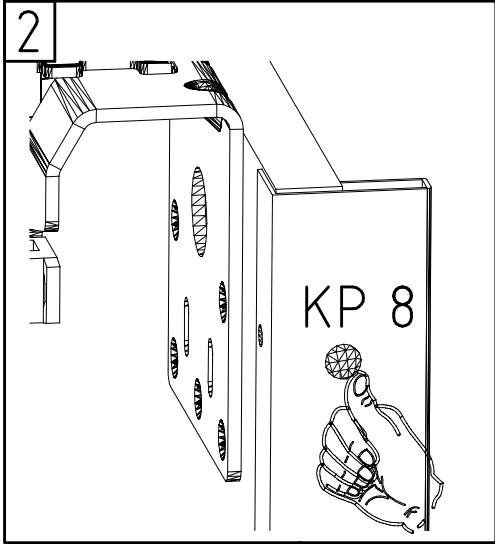
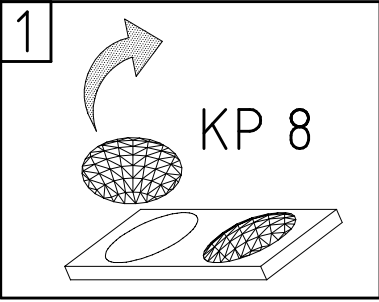

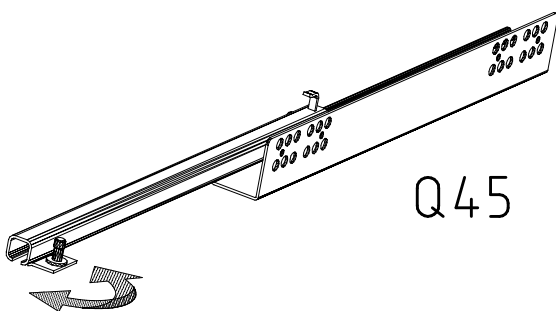
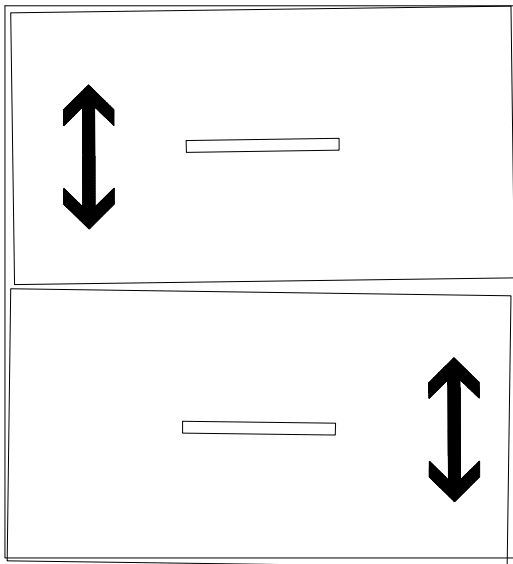

Q45

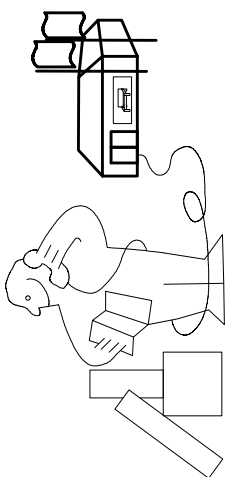

Modell/Model/Modèle

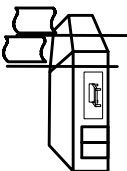
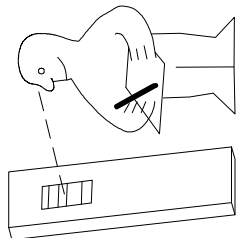

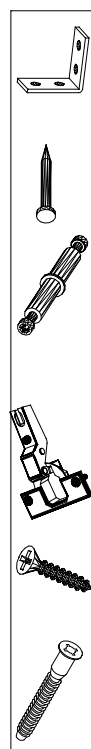
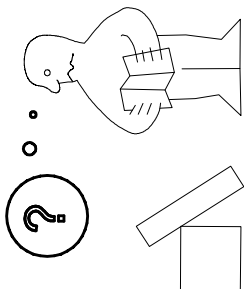

{121 370}	{ G 1 }	{4x}

Änderungen die dem technischen Fortschritt geschuldet sind, behalten wir uns vor!
 Bei nicht vorschriftsmäßiger und/ oder nicht fachmännischer Montage wird bei Personen- und/ oder Sachschäden keinerlei Haftung übernommen.

WIMEX Wohnbedarf/ Import Export Handels GmbH/ Postfach 1407/ 49112 Georgsmarienhütte/ Germany
 Tel.:(+49) 05401 8598 72 Fax.:(+49) 05401 8598 33 Mail: service_H@wimex-online.com

104P-NR. / 104P-NO. 150X-NR. / 150X-NO. Auftrag/Order-No. / No. de Commande

23203 **30110XY** 104

Kunde MAX MUSTERMANN
Customer
Client

Kommission / your order reference / votre reference

3377 MINDEN

Dekor / Decor Decor / Modell / Modele

F99 **SAMPLE**

F99842 SCHWEBETUERENSCHRANK 250 CM H 216CM
PLANKENEICHE NB + RAU STEEL
PLANKENEICHE NACHBILDUNG

202320301107241476000001

Paket / Package / Paquet

414760

SOCKEL

Paket 1 von 8 Colli Kommission 10

HSP-SMT BOD 50 TEXT/TEX SOCKEL 32 FRESH TV / LF 104
SO-BOD TEXT RASTEX/ ZNBOD D18MM TX KLSTA

Montage - Anleitung Laenge 520,0 OBEREN
KS-64 Breite 568,0 OBEREN

SOCKEL32 KLEB

En cas de dommage, veuillez retourner le carton avec le produit. En cas de dommage, veuillez retourner le carton avec le produit.



OBEREN 5 30/19 HAUT 23.08.19 OBEREN 1 1. ABOVE OBEREN



WIMEX Wohnbedarf
Import Export Handelsges mbH & Co. KG
Werner-von-Siemens-Str. 35
D-49124 Georgsmarienhütte - Germany

SAMPLE **23.08.19**
Modellname Produktionsdatum
Model Date of manufacture

