

LIMIT/LIMITED

8100-0086/3300-0019-0086
3100-0019-0086/8300-0086

F/B

- | | | | |
|-----------|--|-----------|---|
| D | MONTAGEANLEITUNG
BEDIENUNGSANLEITUNG | GB | ASSEMBLY INSTRUCTIONS
INSTRUCTION MANUAL |
| NL | HANDLEIDING VOOR DE MONTAGE
GEBRUIKSAANWIJZING | PL | INSTRUKCJA MONTAŻU
INSTRUKCJA OBSŁUGI |
| TR | MONTAJ TALIMATI
KULLANIM KLAVUZU | RU | ИНСТРУКЦИЯ ПО МОНТАЖУ
ИНСТРУКЦИЯ ПО ЭКСПЛУАТАЦИИ |
| RO | INSTRUCȚIUNI DE INSTALARE
INSTRUCȚIUNI DE UTILIZARE | IT | ISTRUZIONI DI MONTAGGIO
MANUALE DI ISTRUZIONI |
| FR | NOTICE DE MONTAGE
MANUEL INSTRUCTIONS | SK | MONTÁŽNY NÁVOD
NÁVOD NA POUŽITIE |
| HU | KÖZGYŰLÉS UTASÍTÁSOK
KEZELÉSI UTASÍTÁS | CZ | MONTÁŽNÍ NÁVOD
NÁVOD K POUŽITÍ |
| SI | NAVODILA ZA MONTAŽO
NAVODILA ZA UPORABO | PT | INSTRUÇÕES DE MONTAGEM
MANUAL DO USUÁRIO |
| ES | INSTRUCCIONES DE MONTAJE
MANUAL DEL USUARIO | HR | UPUTE ZA MONTAŽU
UPUTE ZA UPOTREBU |

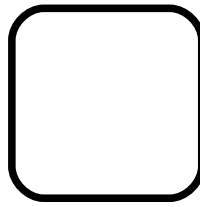
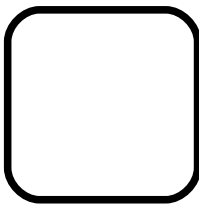

0019

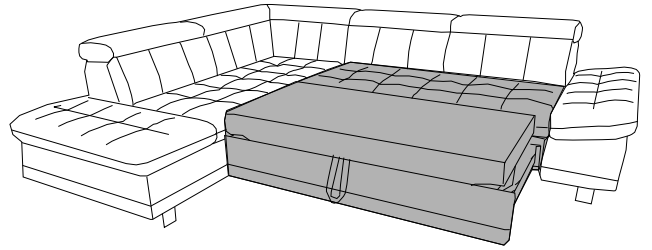
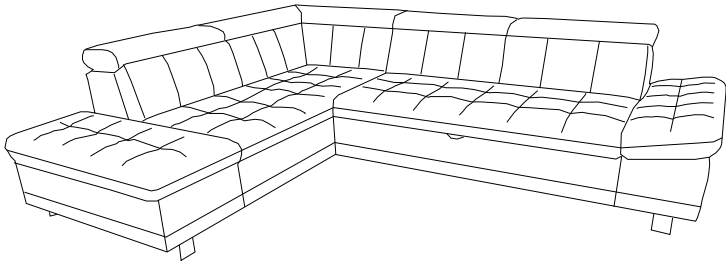

0019

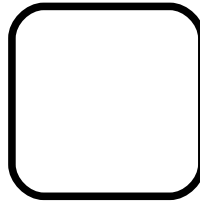
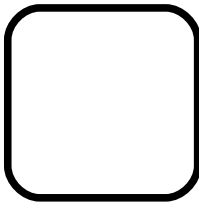

0090

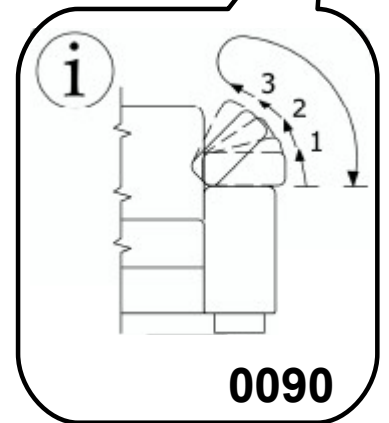
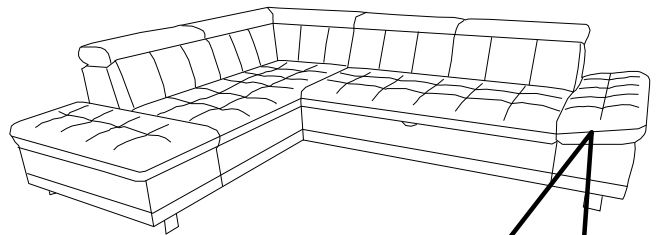
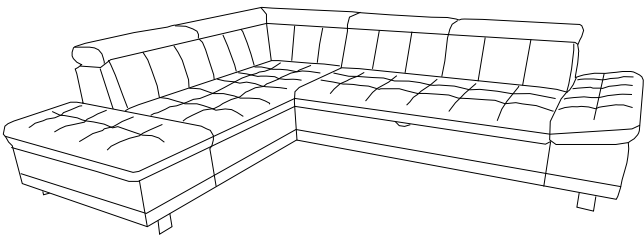

0090

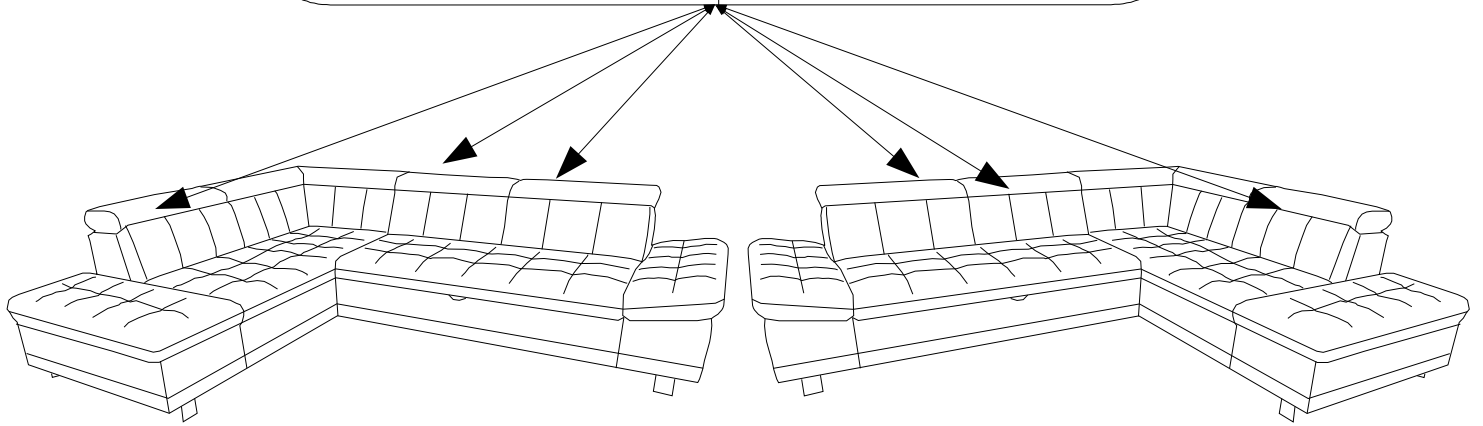
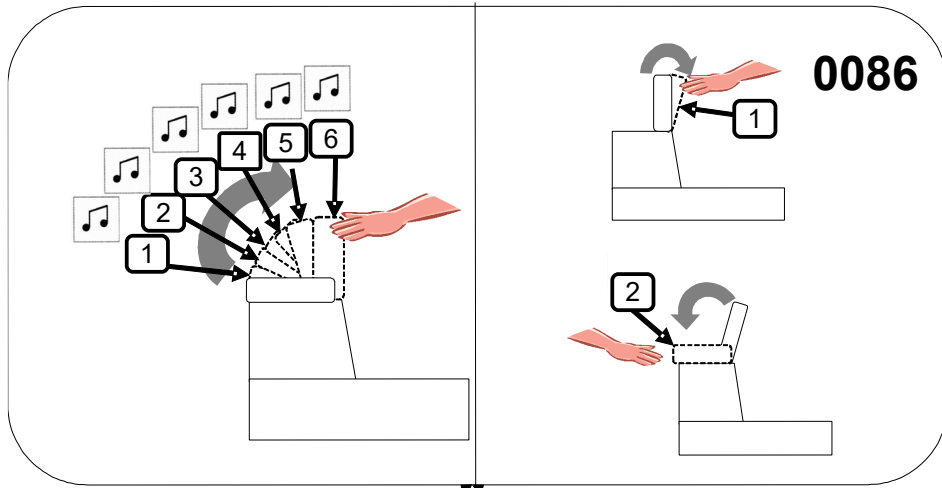









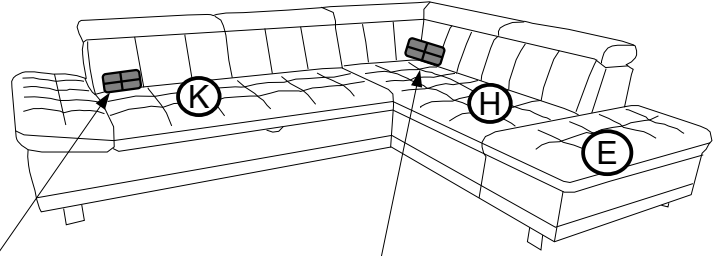
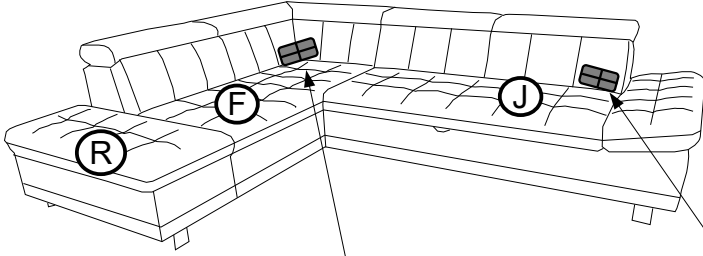



L



R

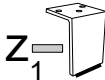



g H- 100  X1	Z H- 100  X 2	V M8*20 [mm]  X6
--	---	--

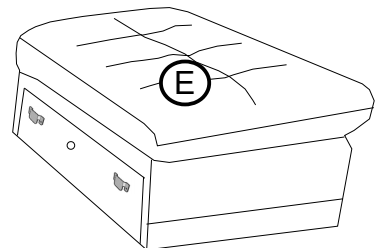
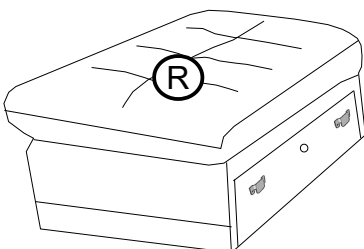
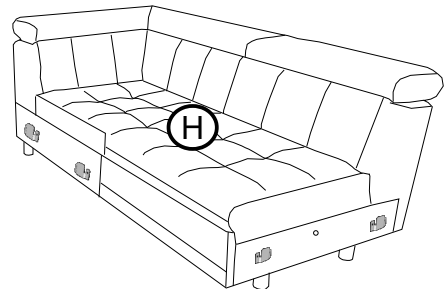
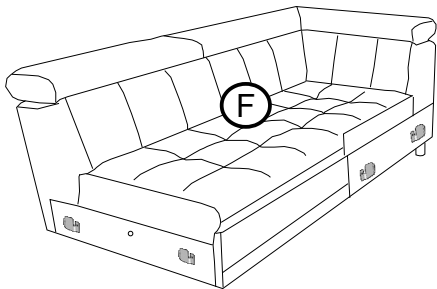
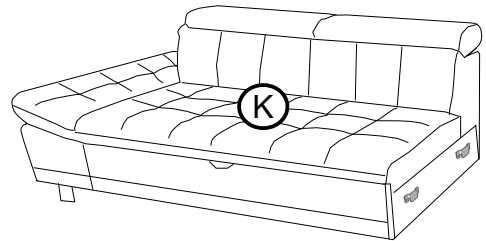
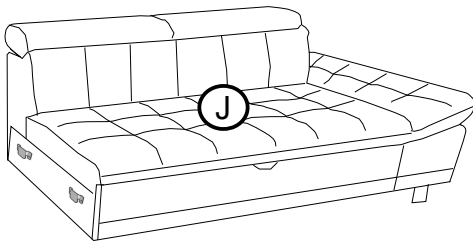

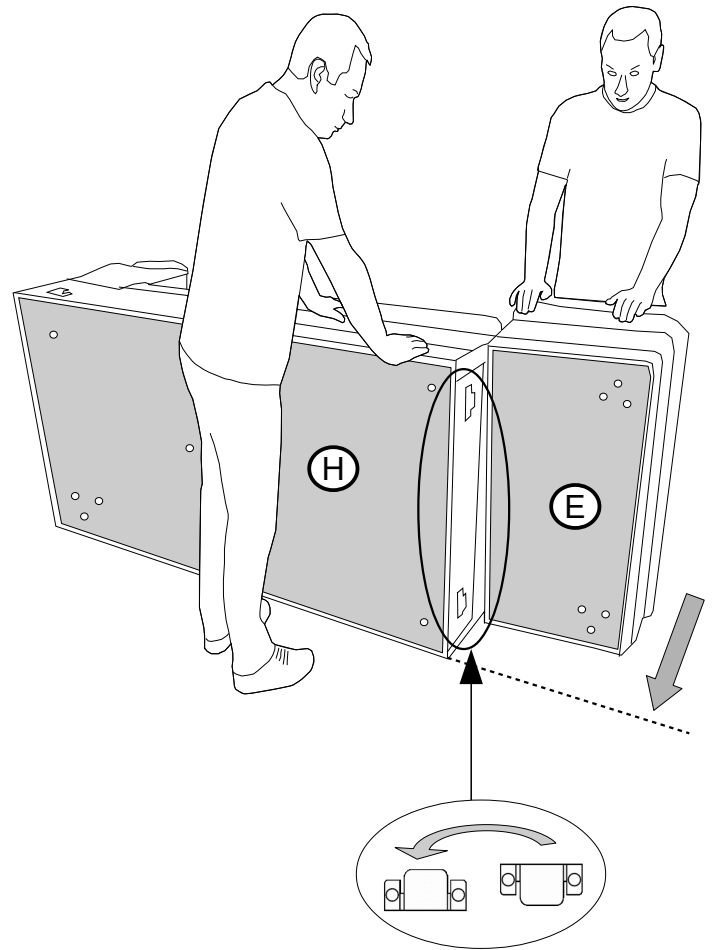
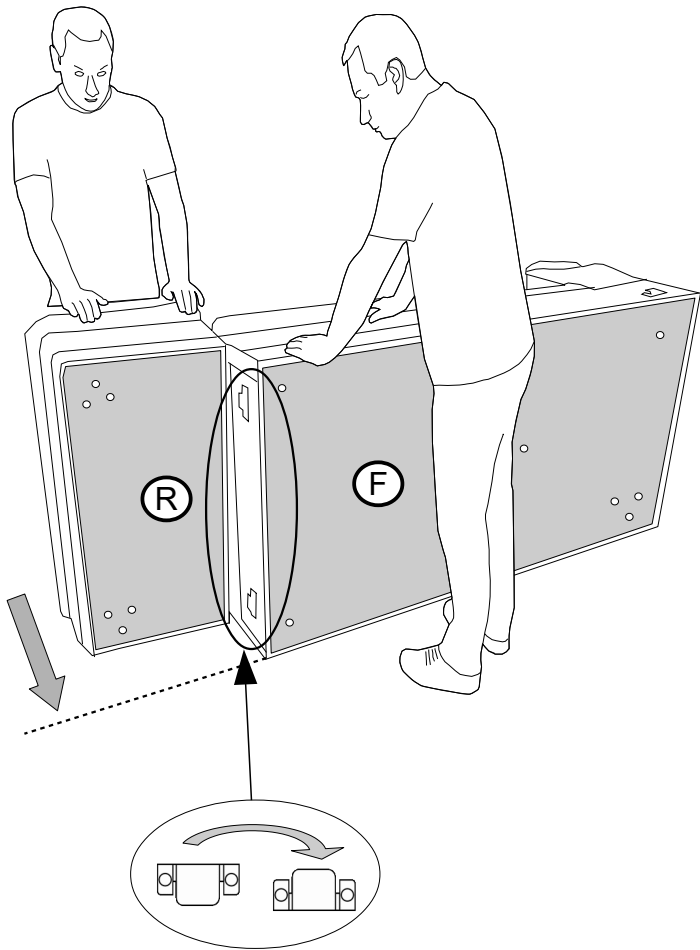
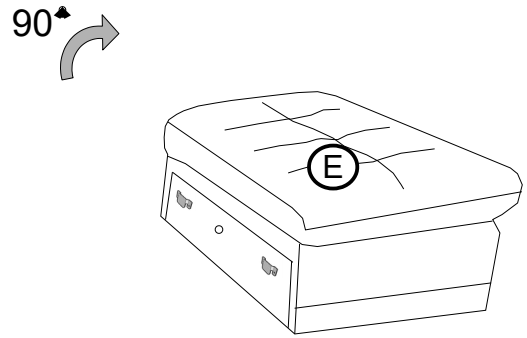
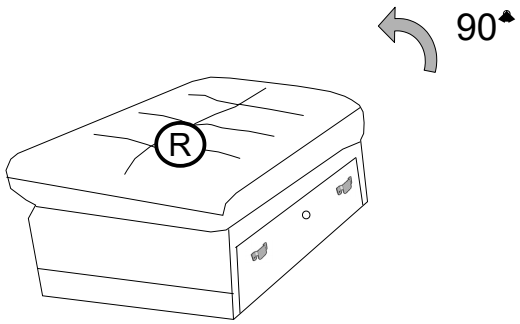
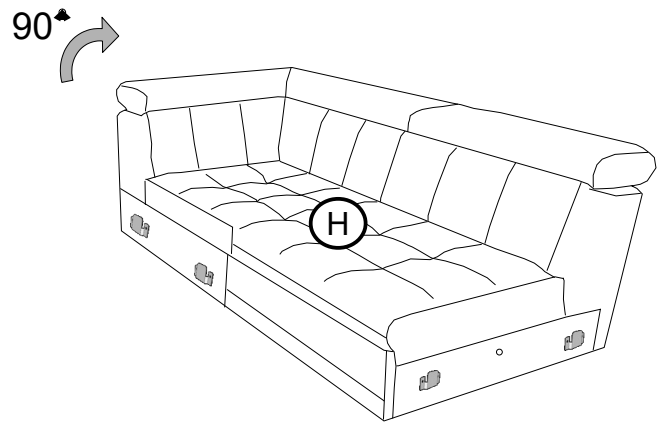
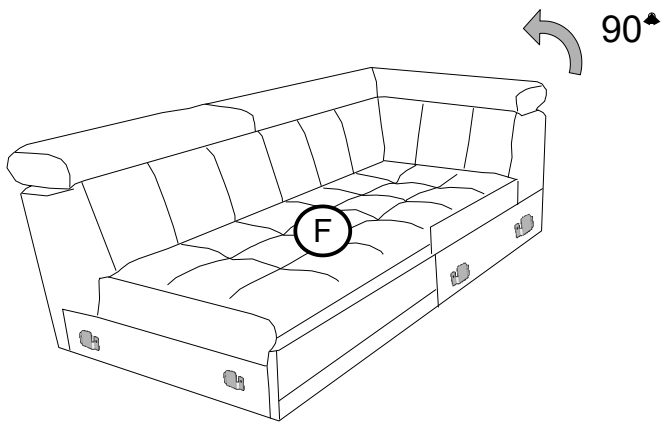

q M8*55  X1	d M8*28  X1	Z H- 100  X3	v M8*20  X9	g H- 100  X3	y H- 100  X1	i L- 5  X1
--	--	---	--	---	---	---



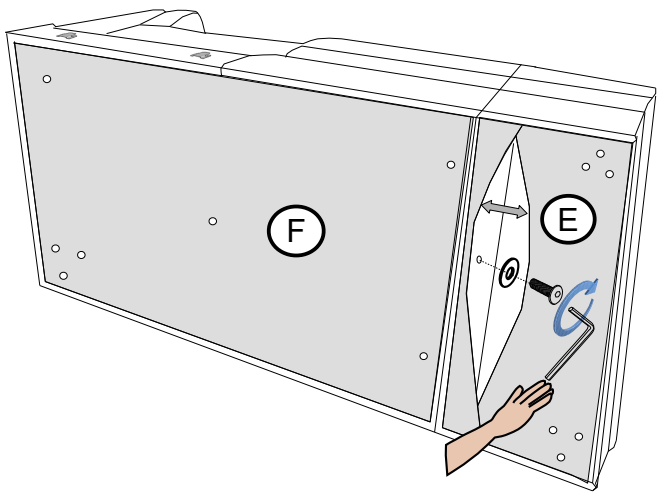
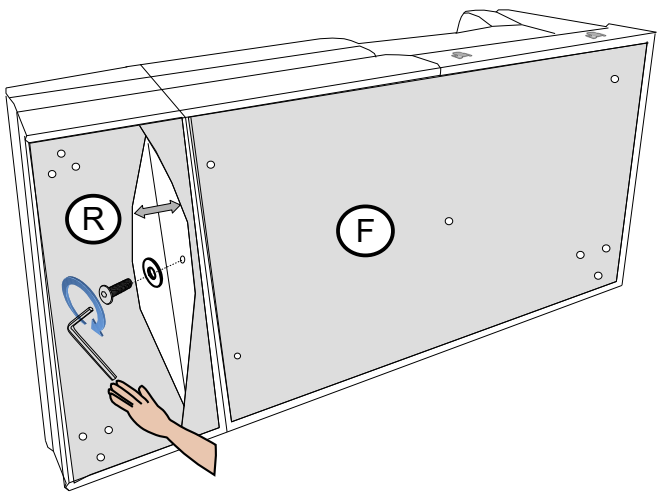





d M8*28	q M8*55	i L-5
		
X1	X1	X1

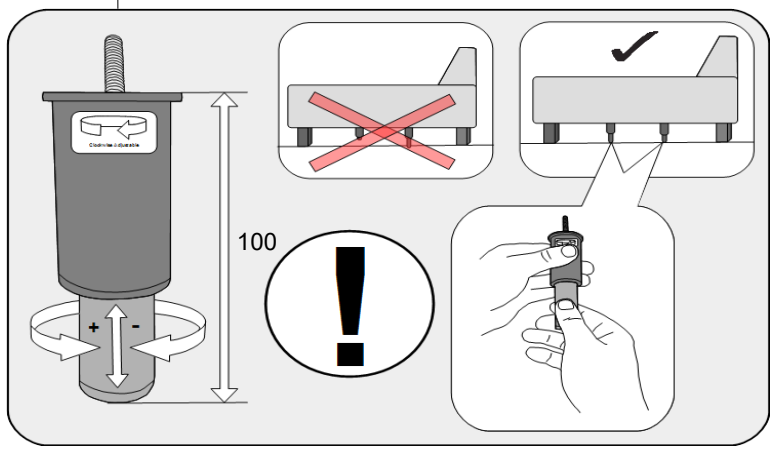
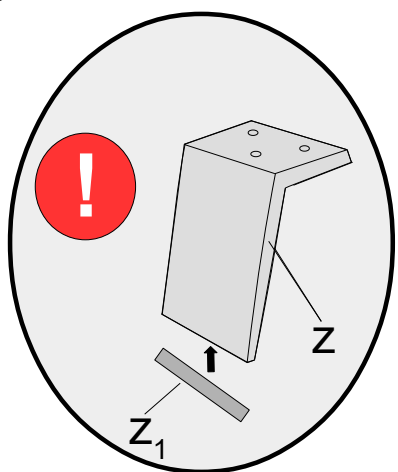
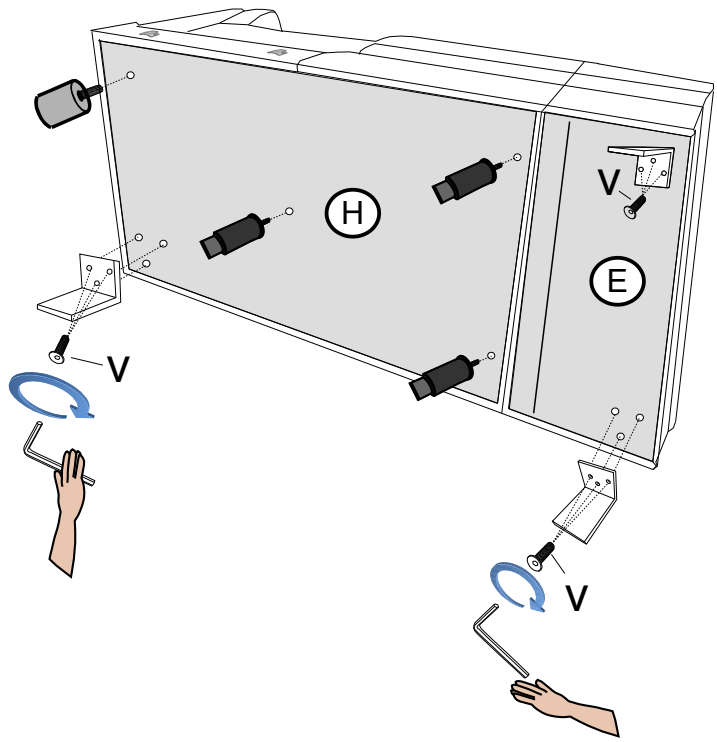
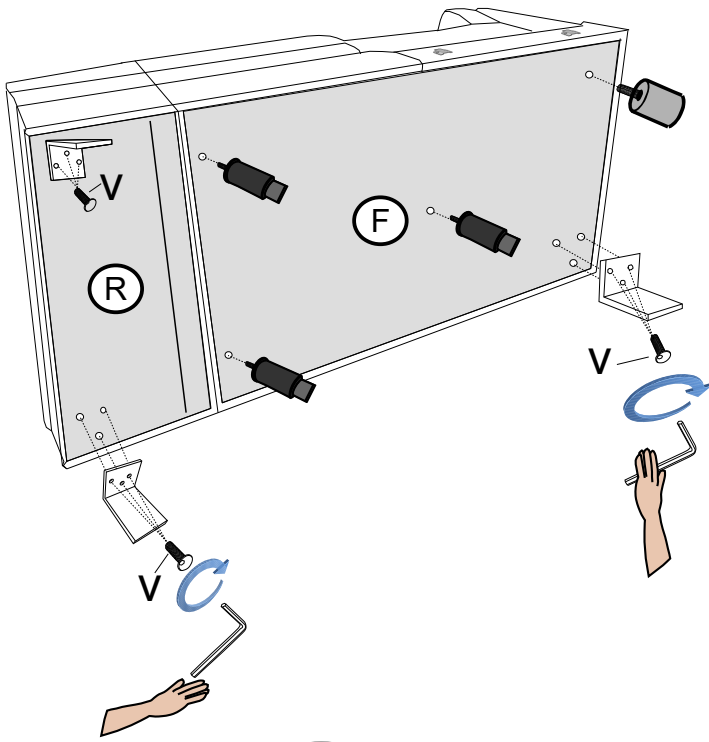

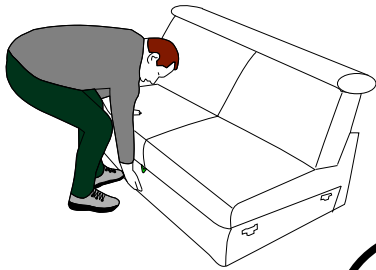
Z H-100	v M8*20	g H-100	y H-100	i L-5
				
X3	X9	X3	X1	X1







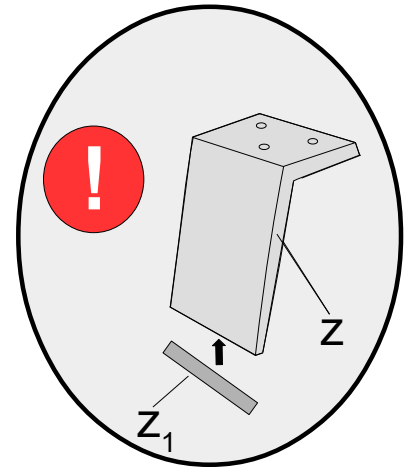

ZH-100  X 2	V M8*20  X 6	i  X 1	g H-100  X 1
--	---	---	--

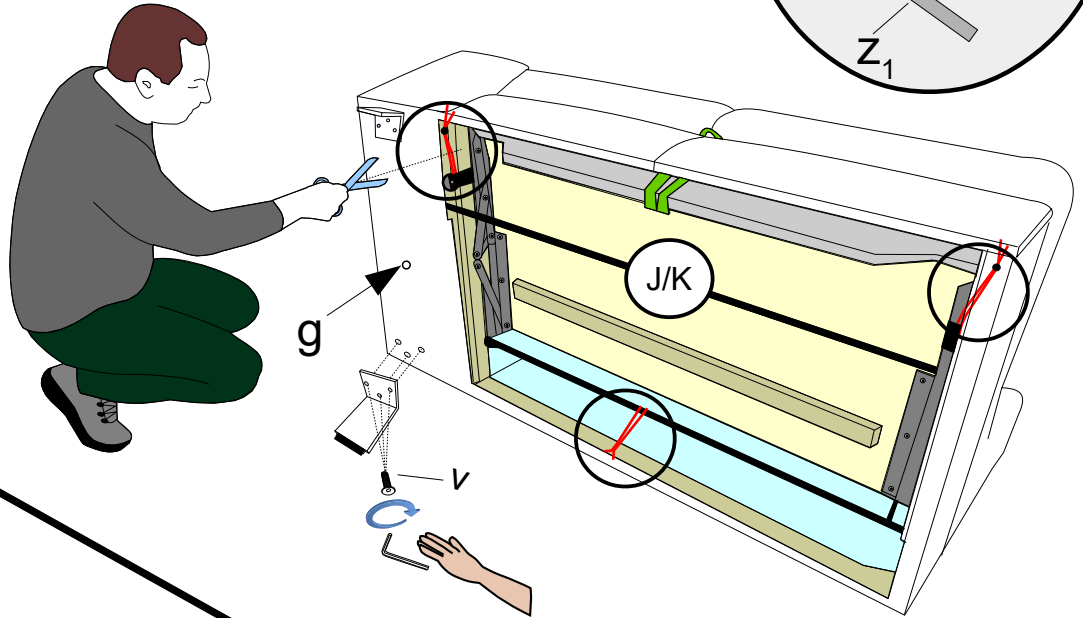

90°



0019

ZH-100  X 2	V M8*20  X 6	i  X 1	g H-100  X 1
--	---	---	---

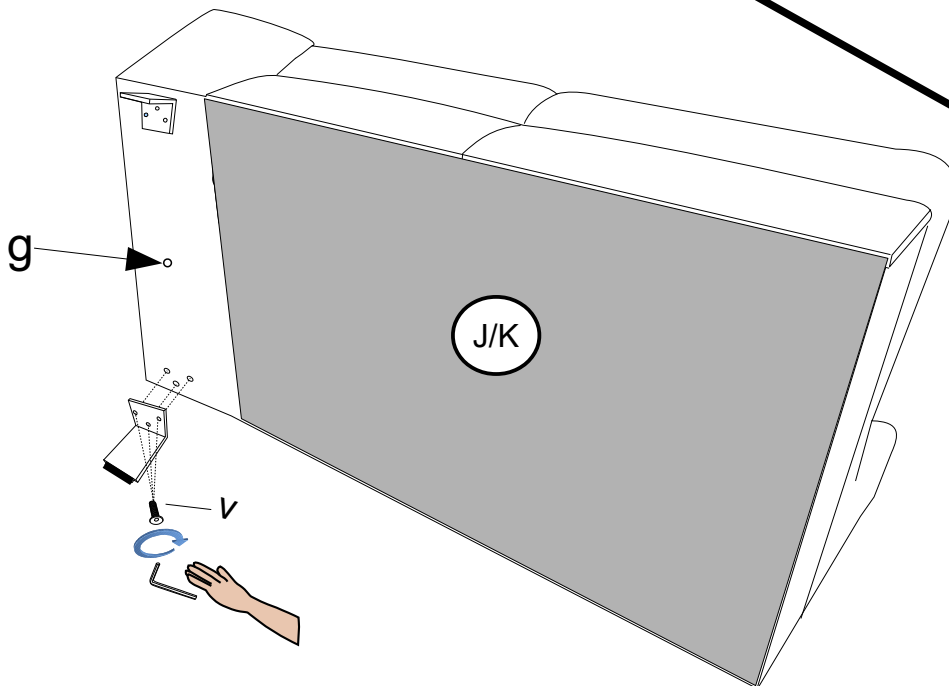

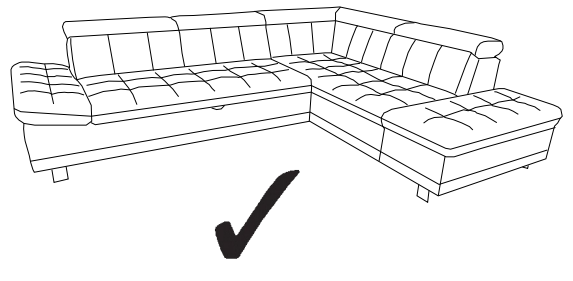
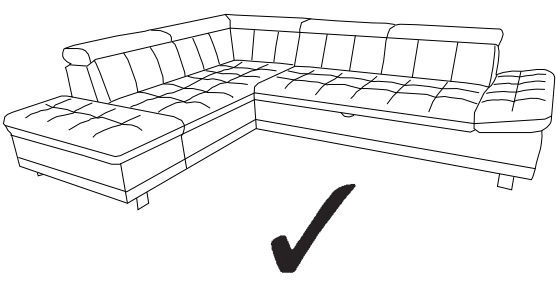
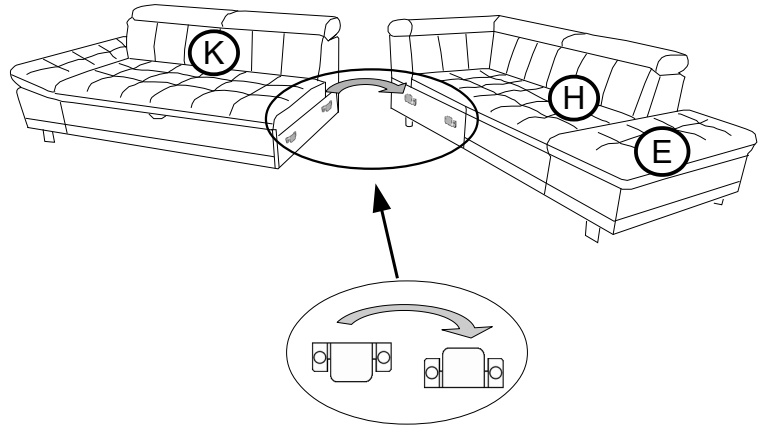
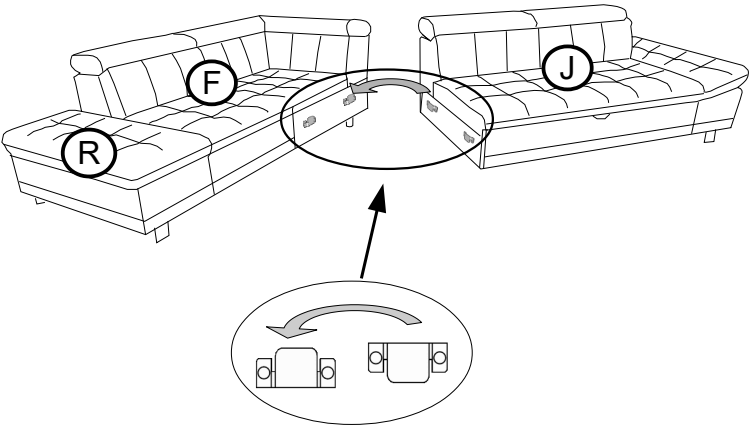
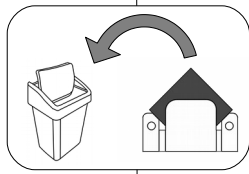

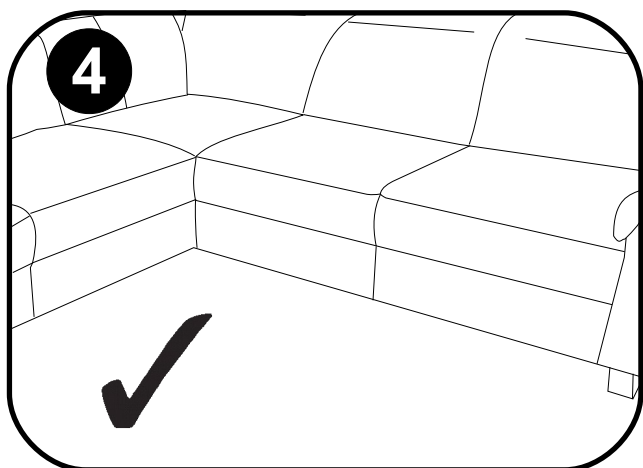
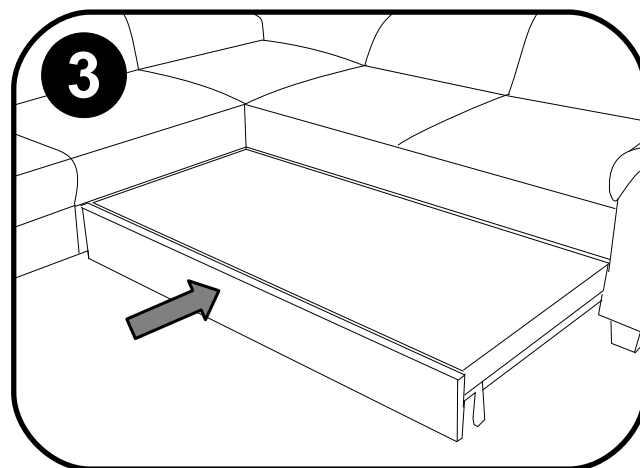
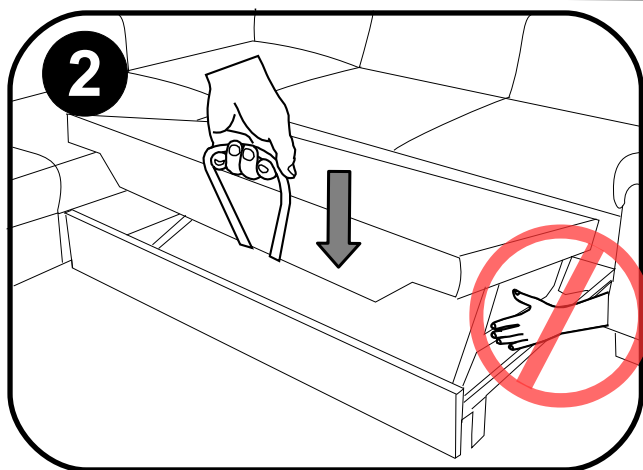
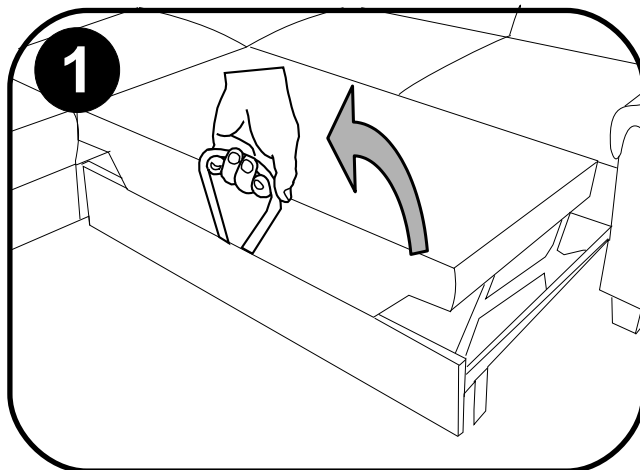
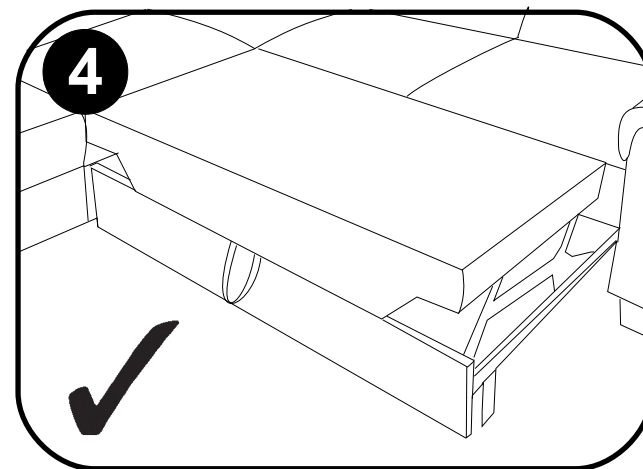
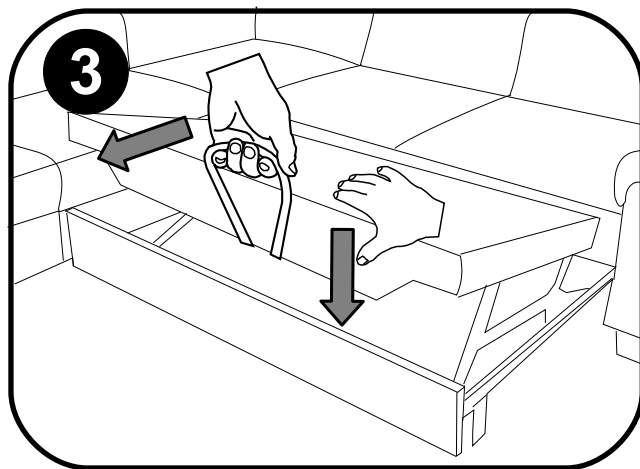
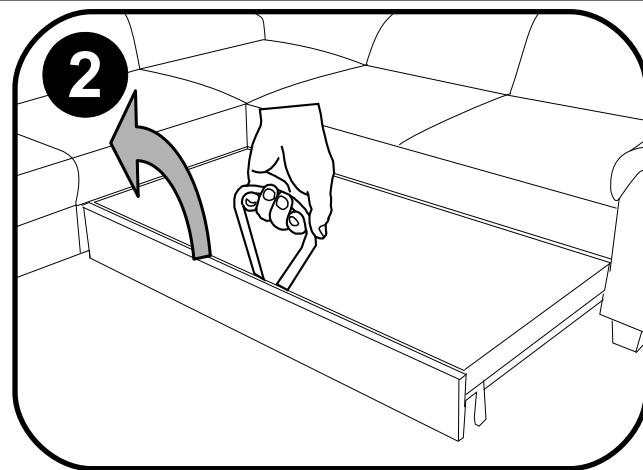
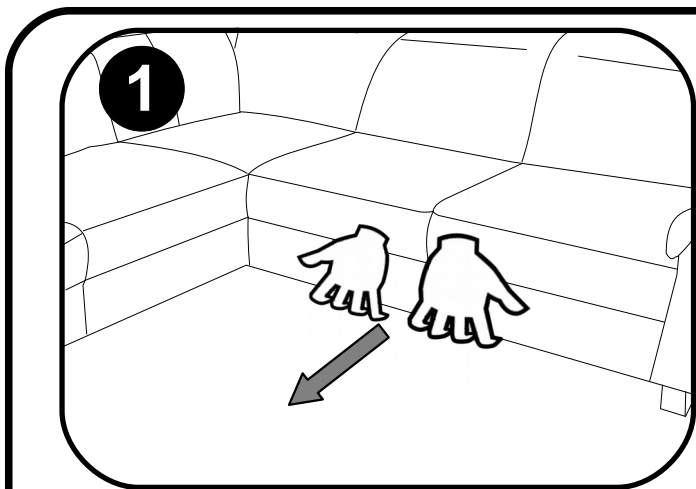
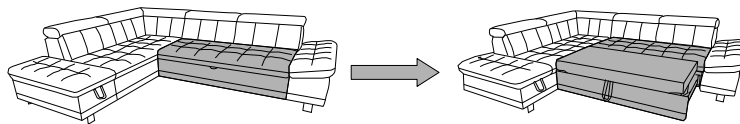

Name · Naam · Nazwa · Ísim · Название · Nume · Nome · Názov · Názov ·
 Název · Neve

LIMIT/LIMITED

Typ · Type · Tip · Тип · Tipo · Típus

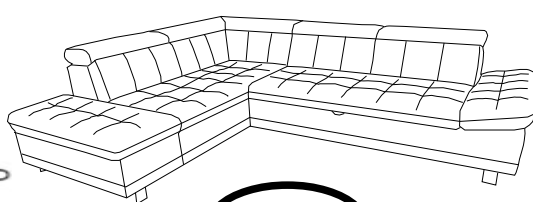
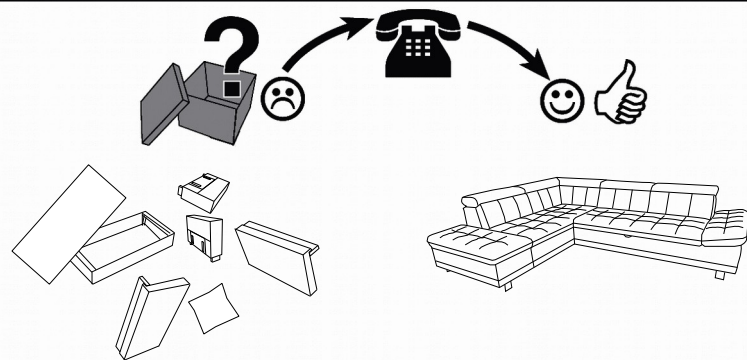
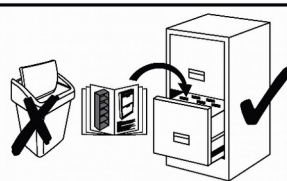

L

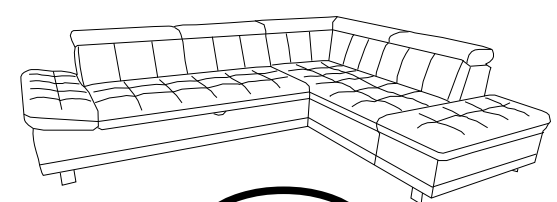

R



q M8*55 	d M8*28 	z H-100 	v M8*20 	g H-100 	y H-100 	i L5 	[mm]
--------------------	--------------------	--------------------	--------------------	--------------------	--------------------	-----------------	------

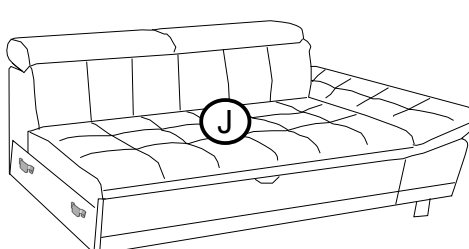

J

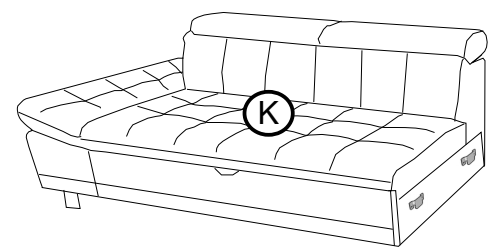

K

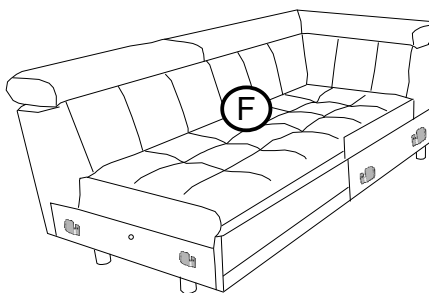

F

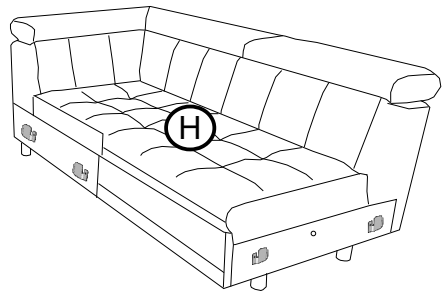

H

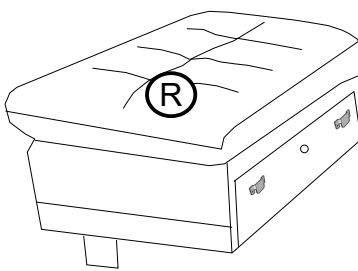

R

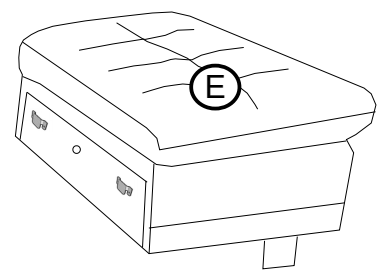

E