

31073102, 75638665, 73408139, 67485527, 40738735, 30901814,  
62333162, 61318000, 37553742, 34037458, 78089906, 52657808,  
**Art. Nr.** 23680445, 28022616, 97400028, 66276565, 77972839, 93107961,  
33123825, 46261854

# Pinto

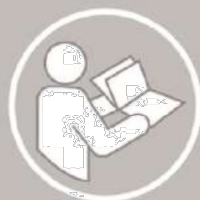

- |      |                             |      |                         |
|------|-----------------------------|------|-------------------------|
| (D)  | Montageanleitung            | (GB) | Assembly instructions   |
| (FR) | Notice de montage           | (IT) | Istruzioni di montaggio |
| (NL) | Handleiding voor de montage | (PL) | Instrukcja montażu      |
| (CZ) | Montážní návod              | (SK) | Návod na montáž         |
| (HU) | Szerelési útmutató          | (RO) | Instrucțiuni de montaj  |
| (TR) | Montaj talimati             | (RU) | Инструкция по монтажу   |

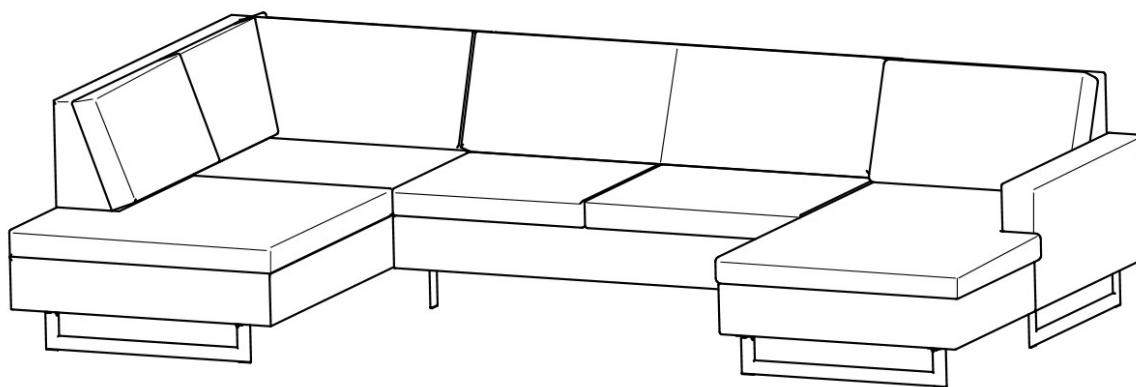
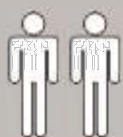

110 kg-MAX

LKZ 41507

# Service • Assistenza • Dienstverlening • Serwis Servis • Szerviz • Сервисная служба

Name • Nom • Nome • Naam •  
Nazwa • Jméno • Název • Név •  
Denumire • Ísim • Название

Pinto

Nr. • No. • N° • Номер • Č • Sz

31073102, 75638665, 73408139, 67485527, 40738735, 30901814,  
62333162, 61318000, 37553742, 34037458, 78089906, 52657808,  
23680445, 28022616, 97400028, 66276565, 77972839, 93107961,  
33123825, 46261854

Typ • Type • Tip •  
Típus • Tipo • Тип

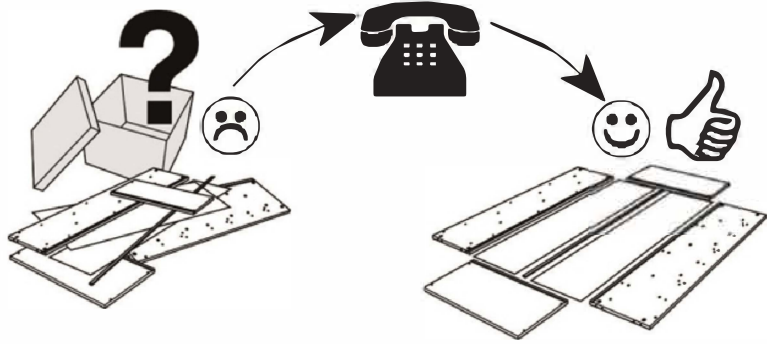
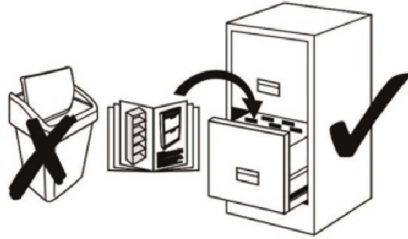

1

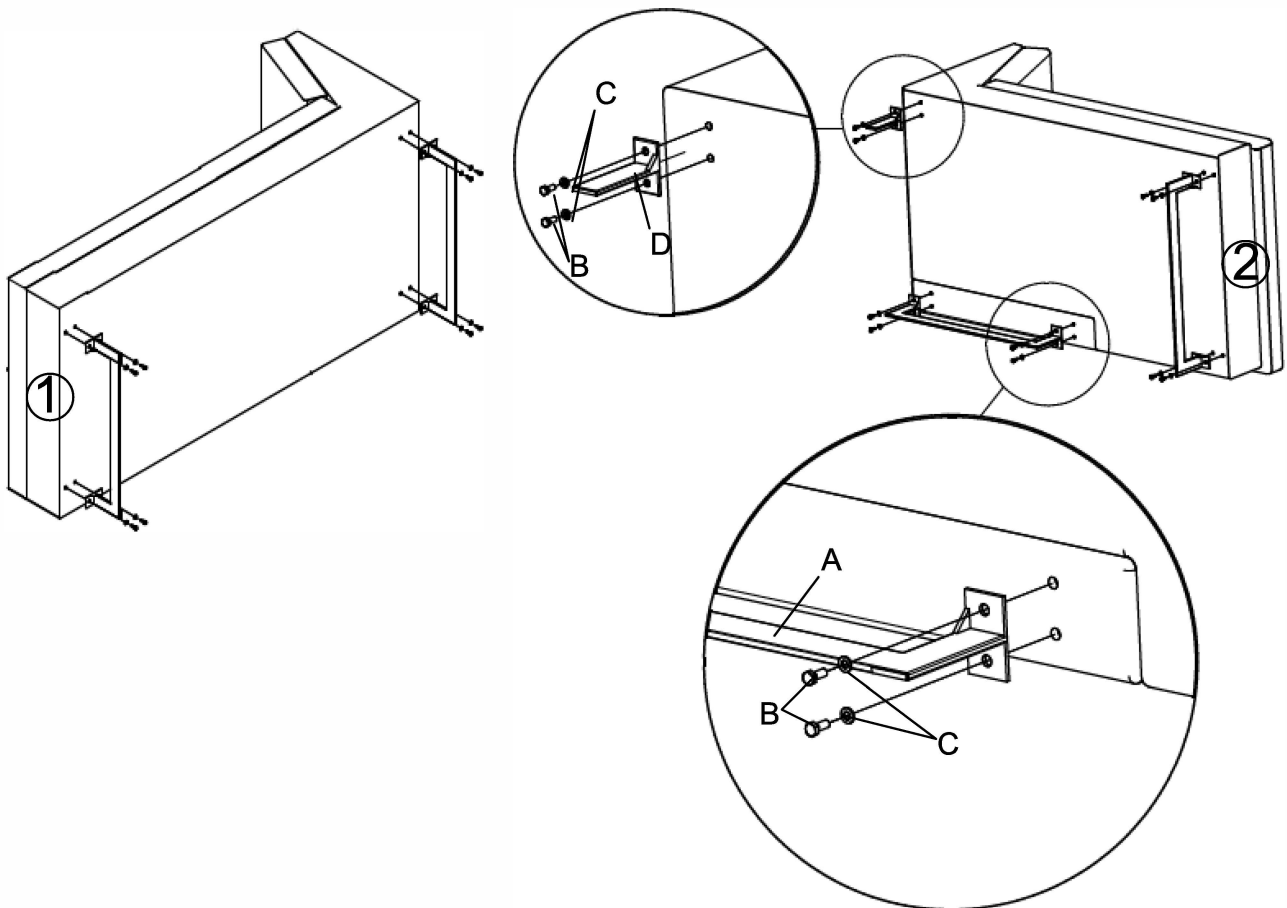
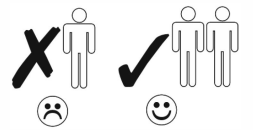

<b>A</b>		<b>B</b>		<b>C</b>		<b>D</b>	
L=800, H=150	x4	M8x25	x26	M8x16	x26	H=150	x5

