

# Axel Table

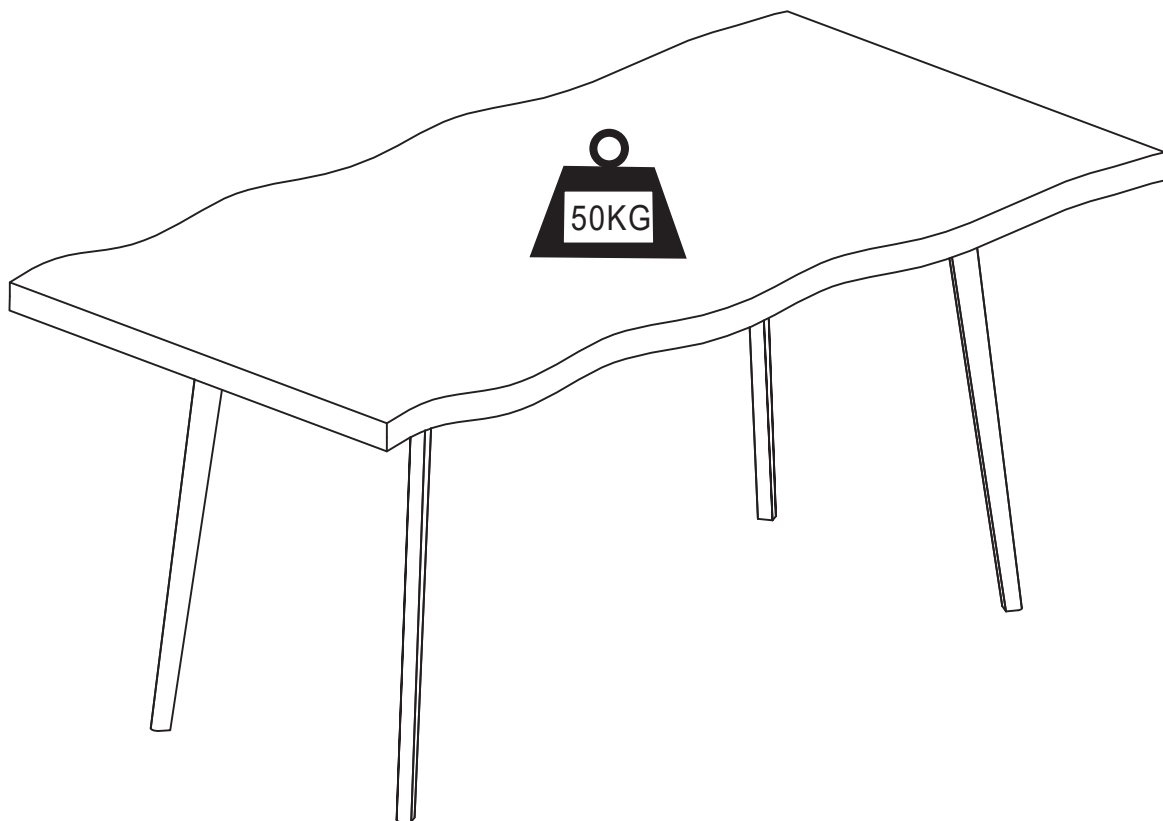

**(D)** Montageanleitung

**(FR)** Notice de montage

**(NL)** Handleiding voor de montage

**(CZ)** Montážní návod

**(HU)** Szerelési útmutató

**(TR)** Montaj talimatı

**(GB)** Assembly instructions

**(IT)** Istruzioni di montaggio

**(PL)** Instrukcja montażu

**(SK)** Návod na montáž

**(RO)** Instrucțiuni de montaj

**(RU)** ИНСТРУКЦИЯ ПО МОНТАЖУ

**Service • Assistenza • Dienstverlening • Serwis  
Servis • Szerviz • Сервисная служба**

Name • Nom • Nome • Naam •  
Nazwa • Jméno • Názov • Név •  
Denumire • Isim • Название

Nr. • No. • N° • Номер • Č • Sz

Тур • Туре • Тир • Típus • Тиро •  
Тип

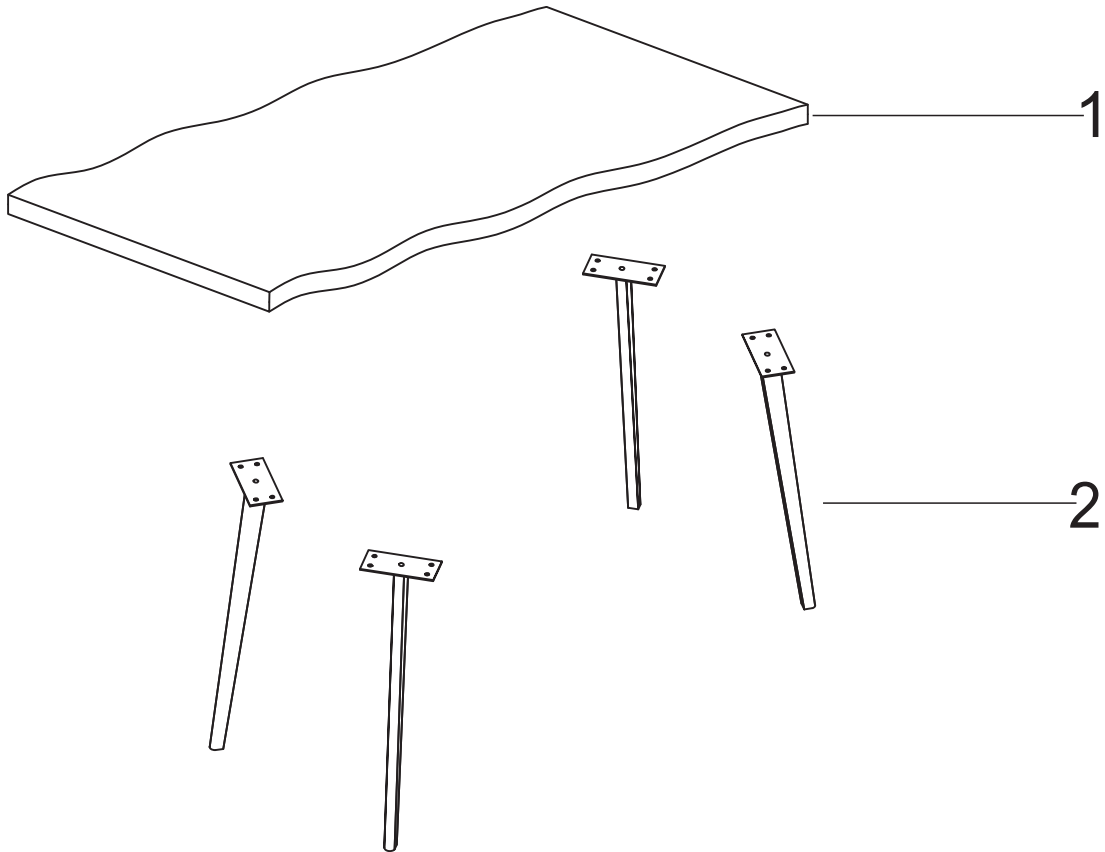
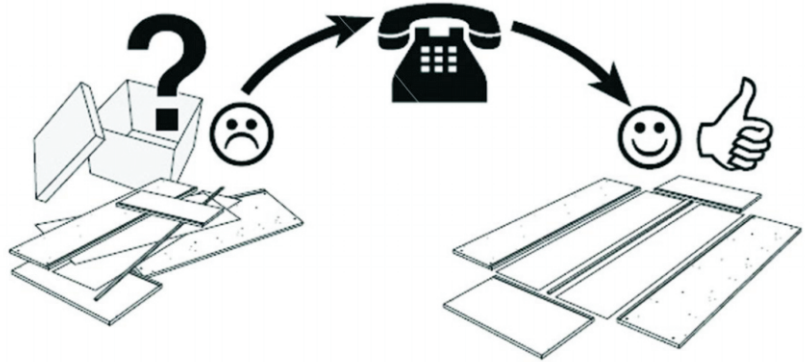
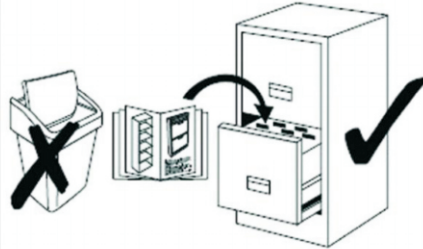

M8X25mm  
A\*16



φ18x1.5mm  
B\*16







5mm  
C\*1

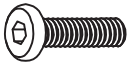

φ15x2mm  
D\*4

**2/4**

	M8X25mm	A*16
	φ18x1.5mm	B*16
	5mm	C*1
	φ15x2mm	D*4

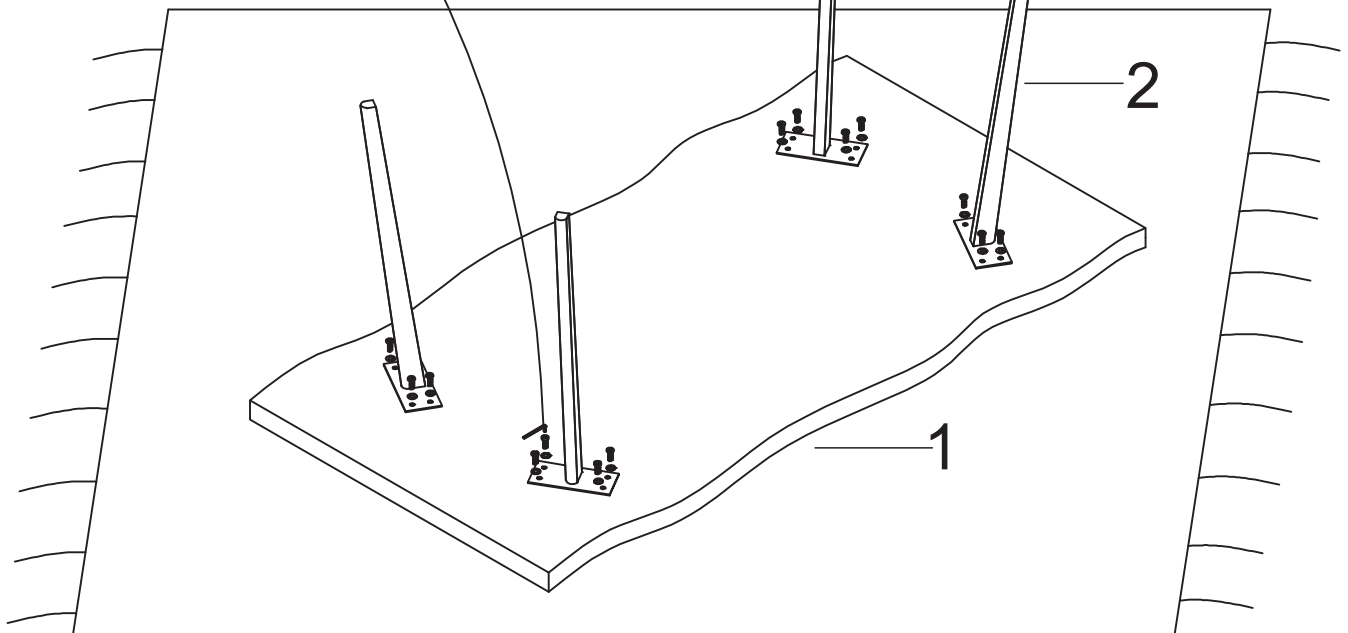
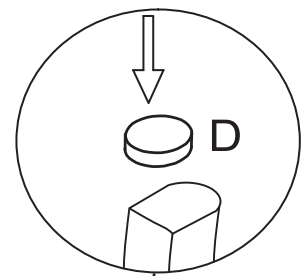
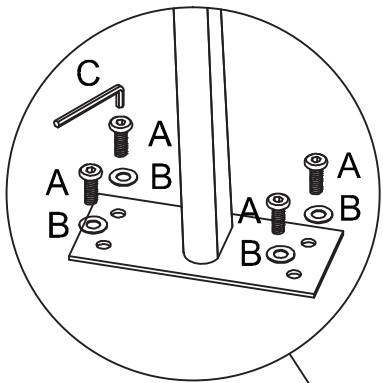

3

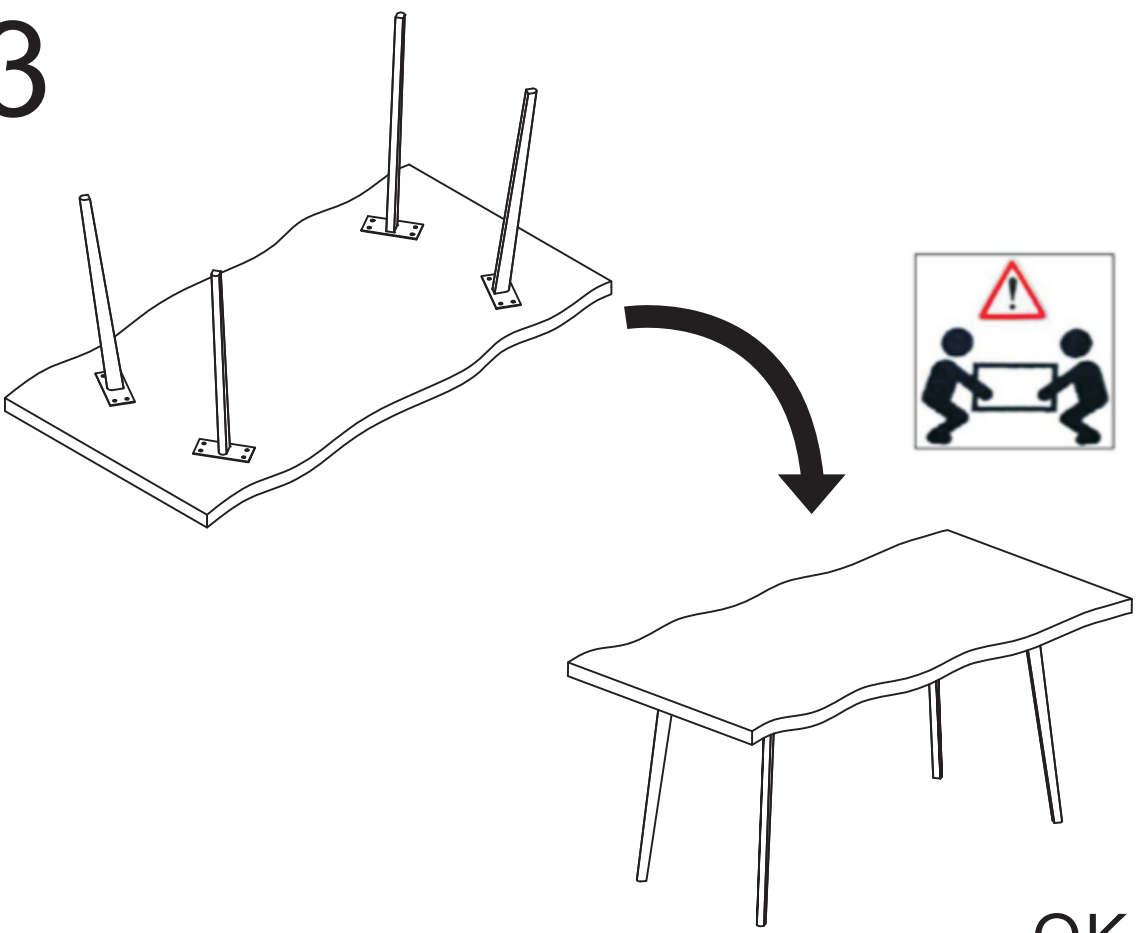

OK

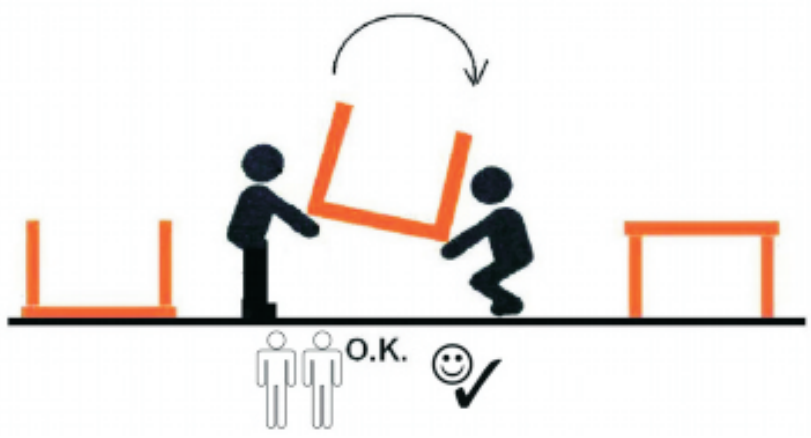
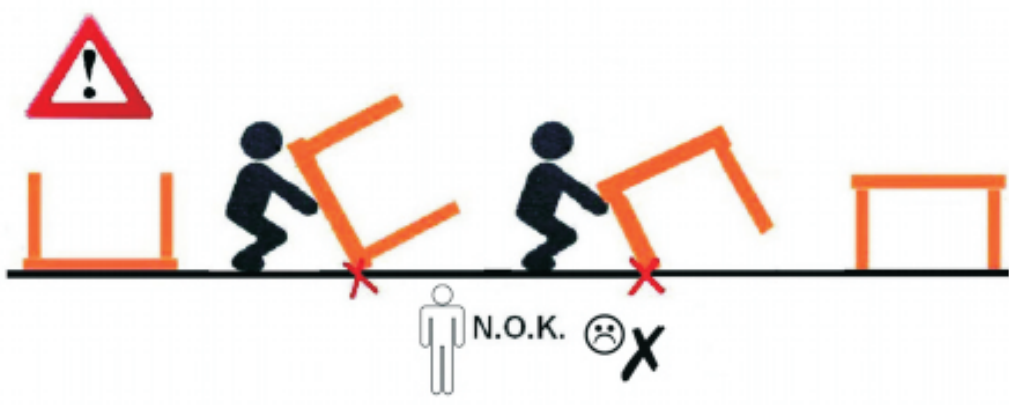

4/4