



x 1



x 1



x 2



x 2

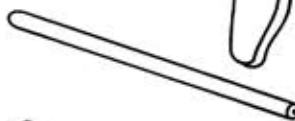

x 1



x 2



x 1

A			X2pcs
		M 8 x 80	
B			X4pcs
		M 8 x 40	
C			X8pcs
		M 7 x 50	
D			X8pcs
		M 7 x 20	
E			X2pcs
		M 7 x 50	
F			X2pcs
		M 4 x 30	
			X2pcs

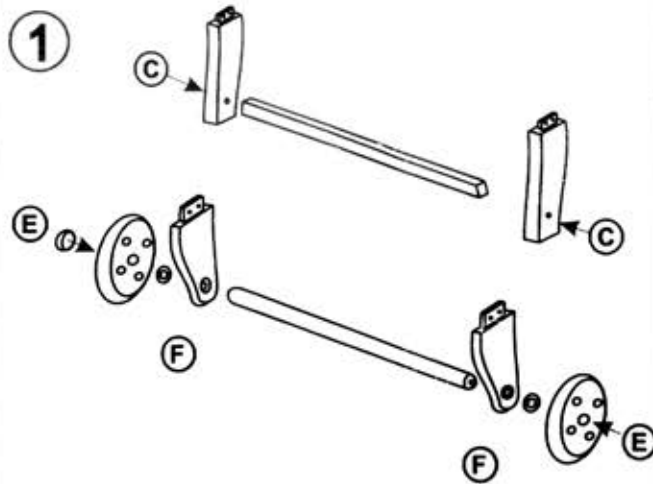

1

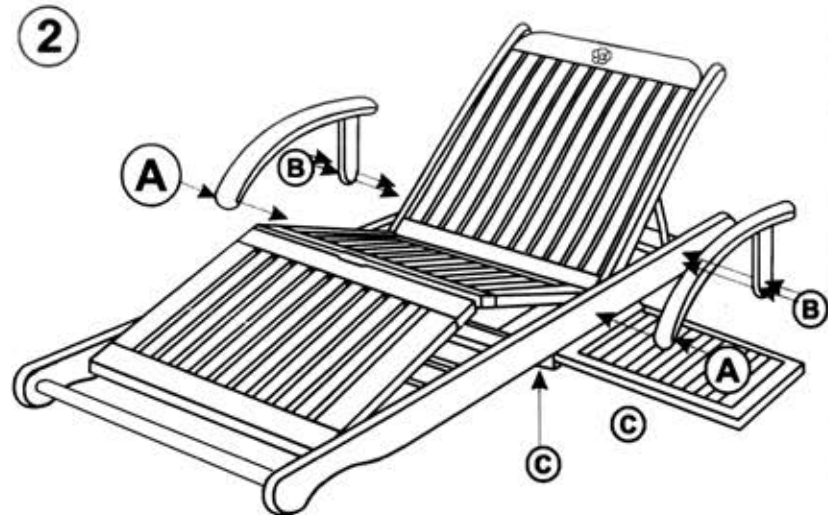

2

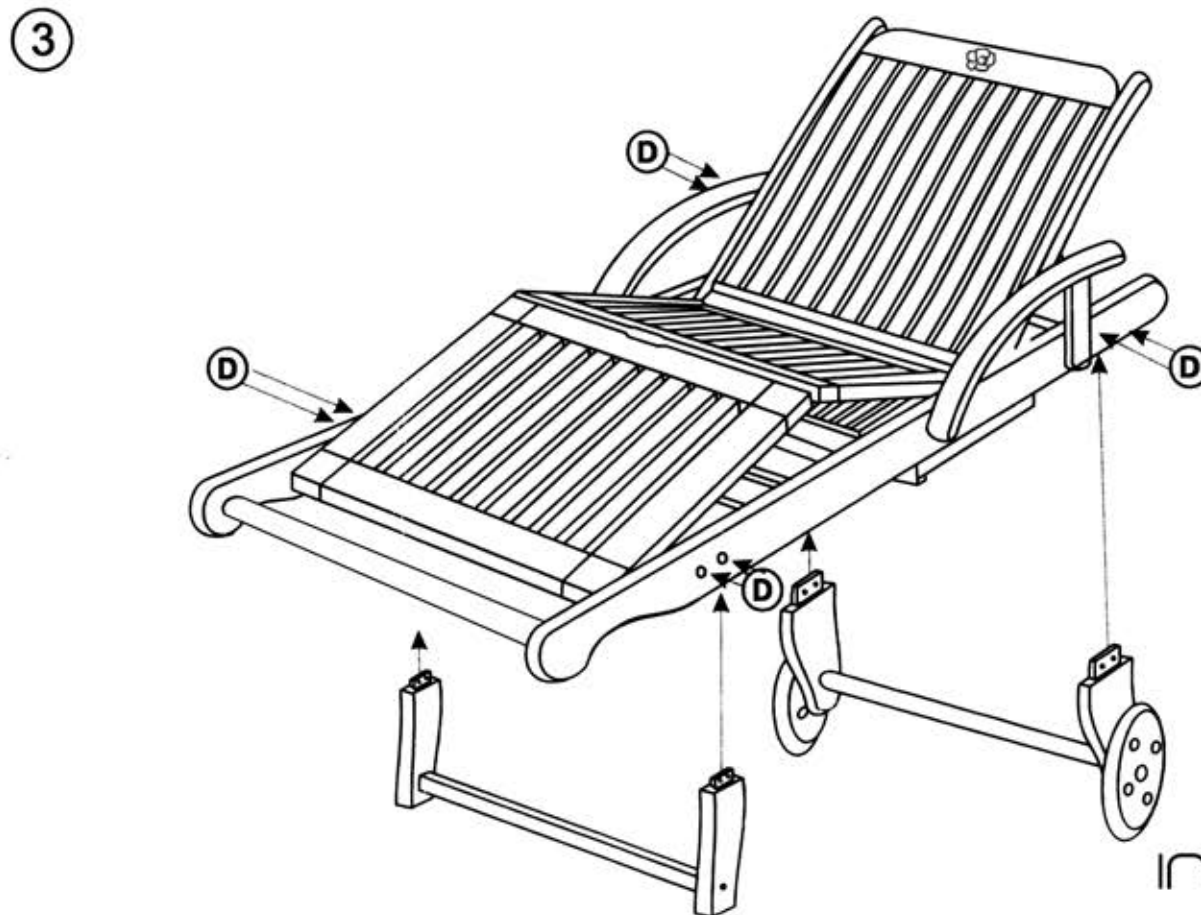

3