

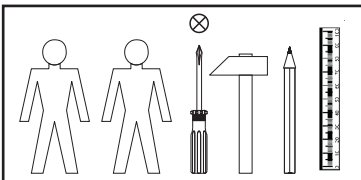













A	B	C	D
1	S 171-002	1069x376	1/1
2	S 171-105	1075x346	1/1
3	S 171-106	1075x346	1/1
4	S 171-202	791x350	1/1
5	S 171-204	791x350	1/1
6	S 171-302A	757x309	1/1
7	S 171-903	1089x771	1/1

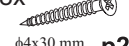

2x  c328	4x  K16 a1	4x  φ7x50 mm e1	8x  φ5 d1	8x  φ8x30 mm f1
4x  φ4x30 mm p9	4x  b1	4x  56x56x20 mm k52	8x  φ4x30 mm p21	4x  φ15x12mm #16 r1
6x  I2	4x  r42	4x  ø16 s2	1x  z1	

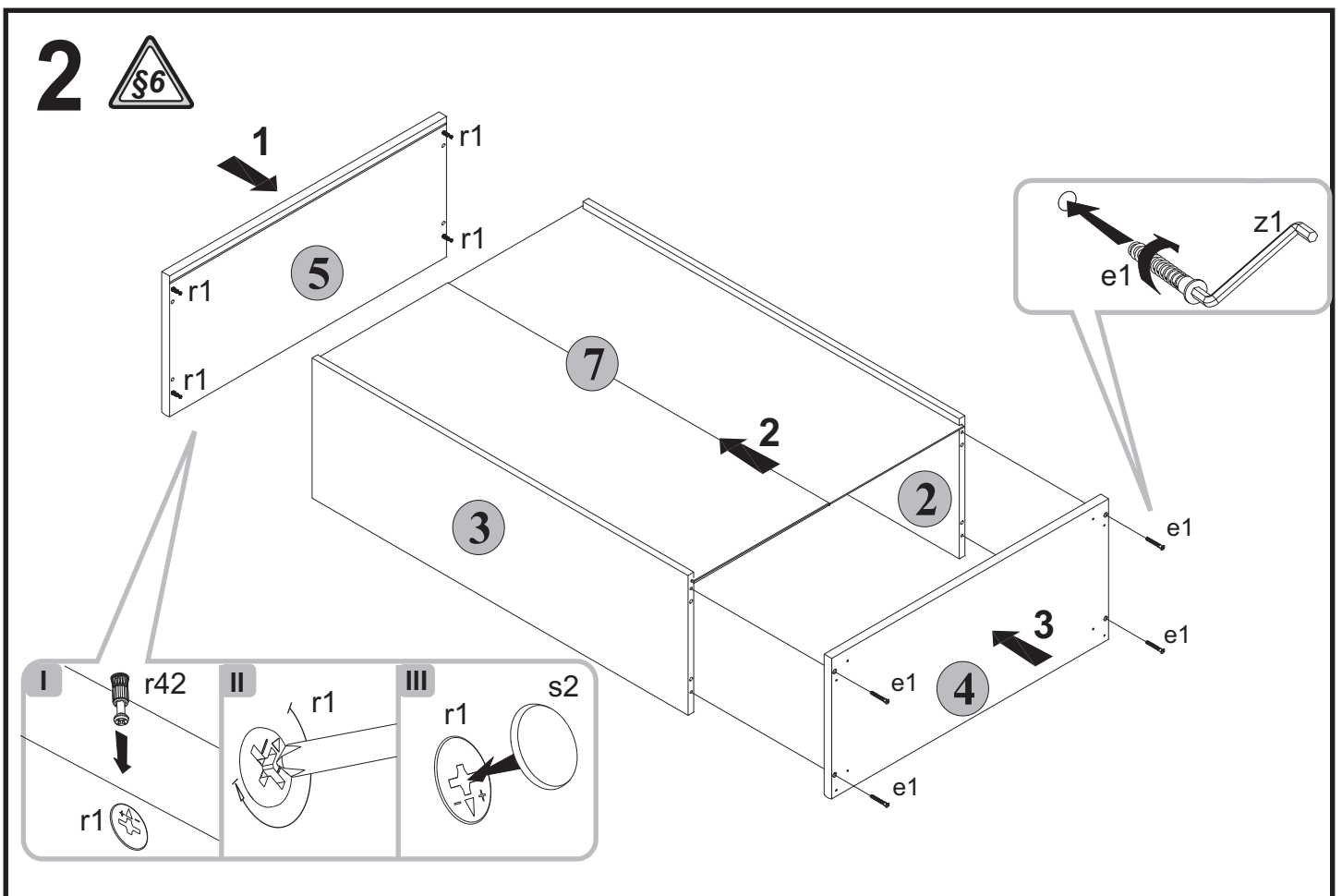
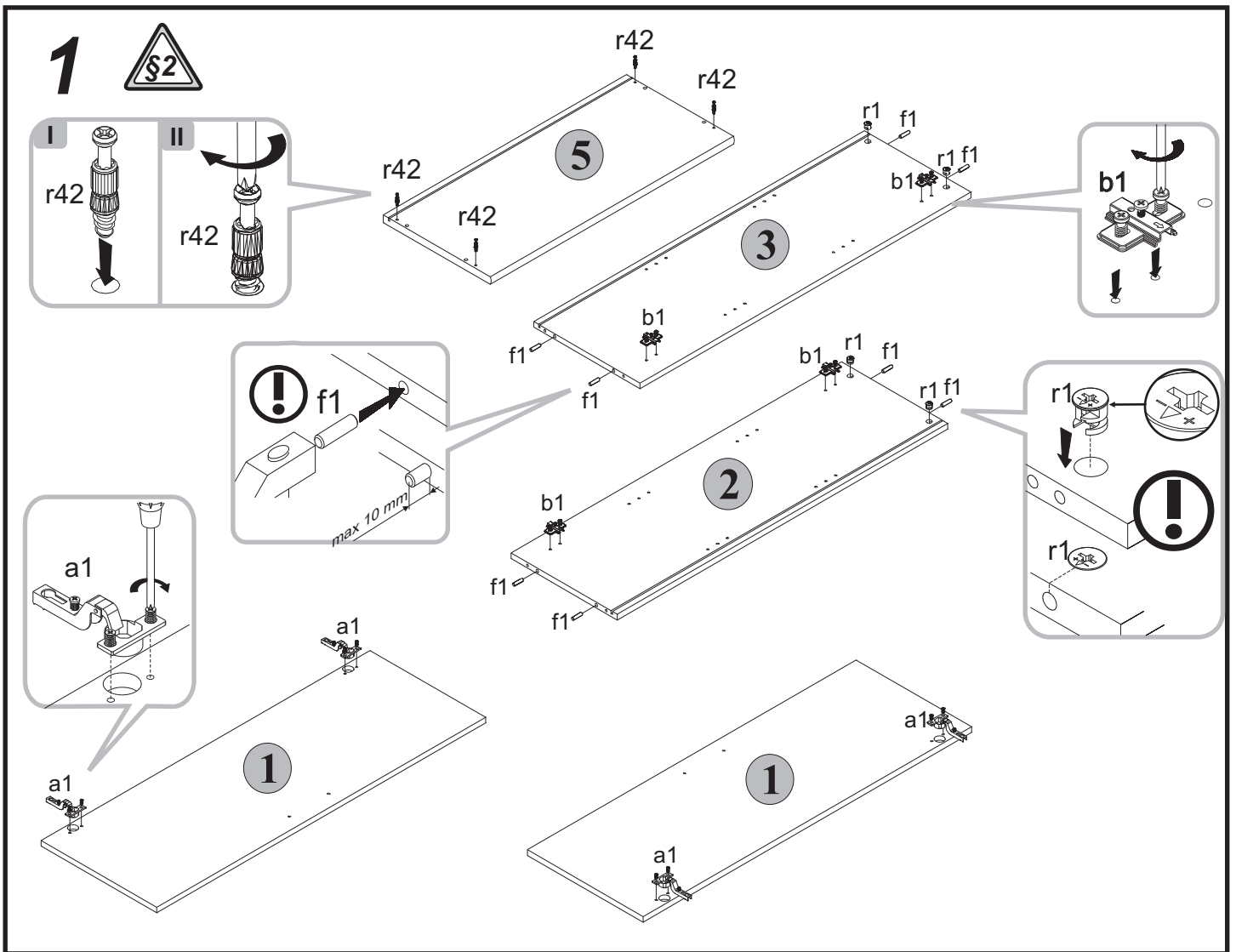

3

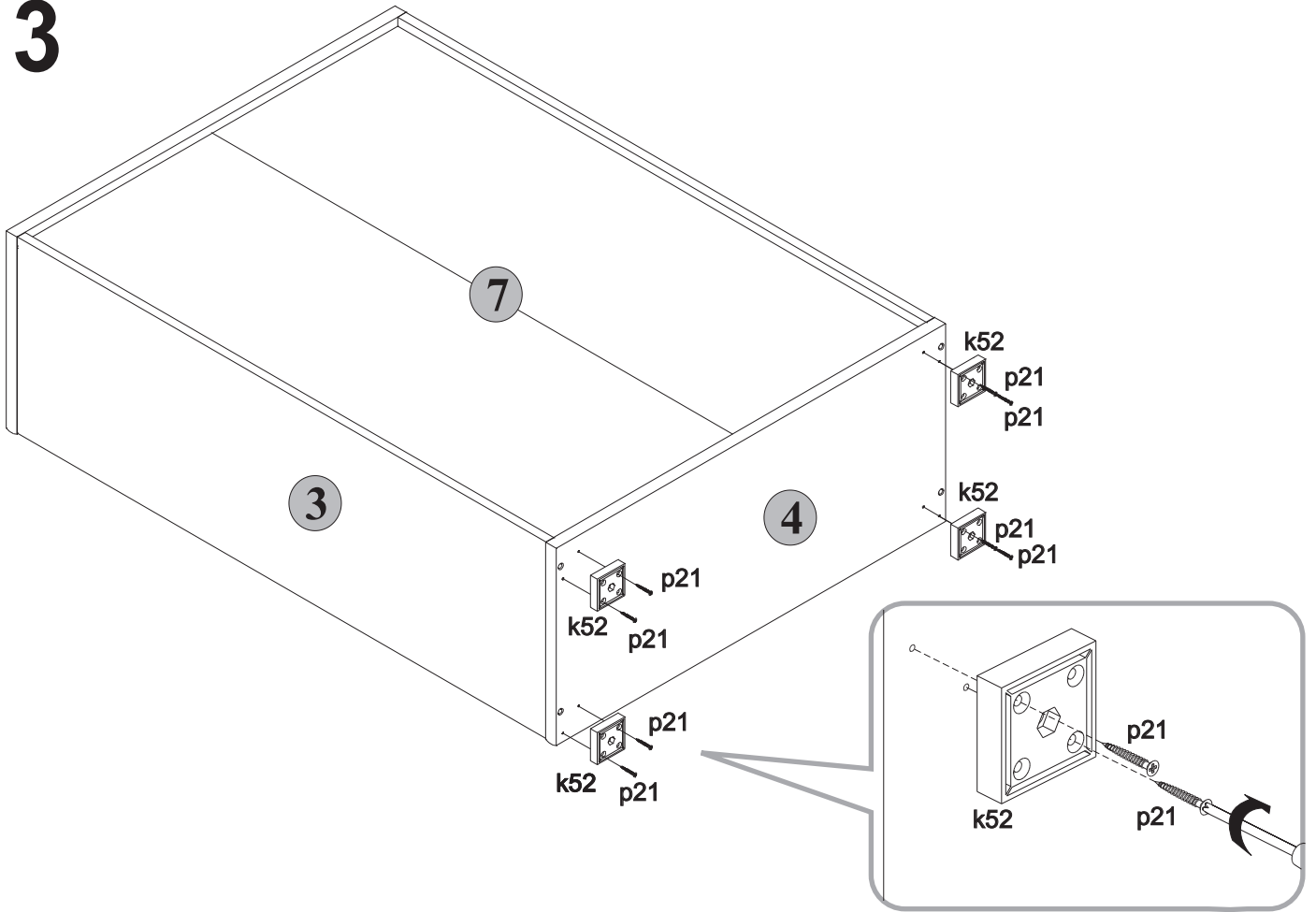

4

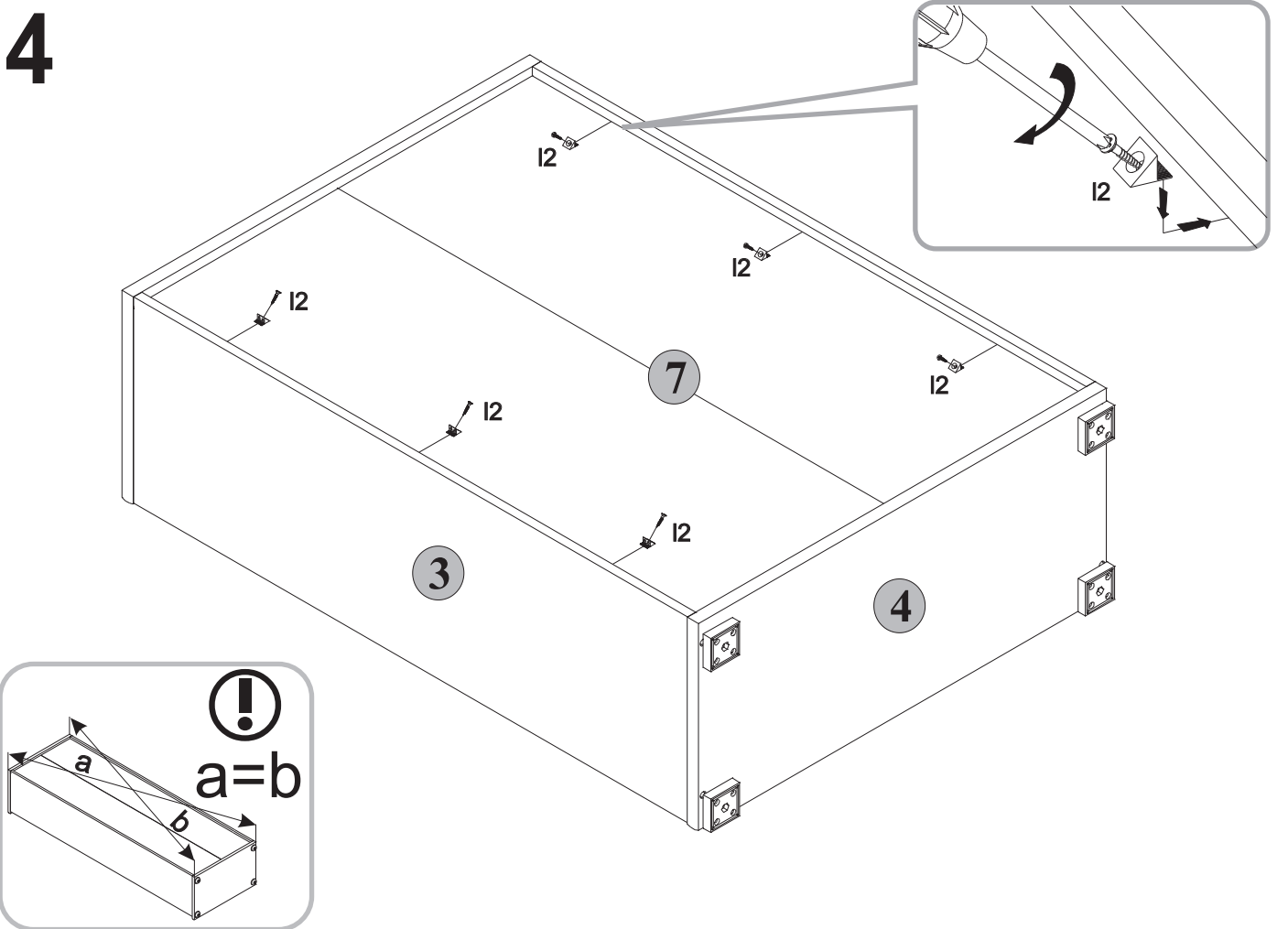

5

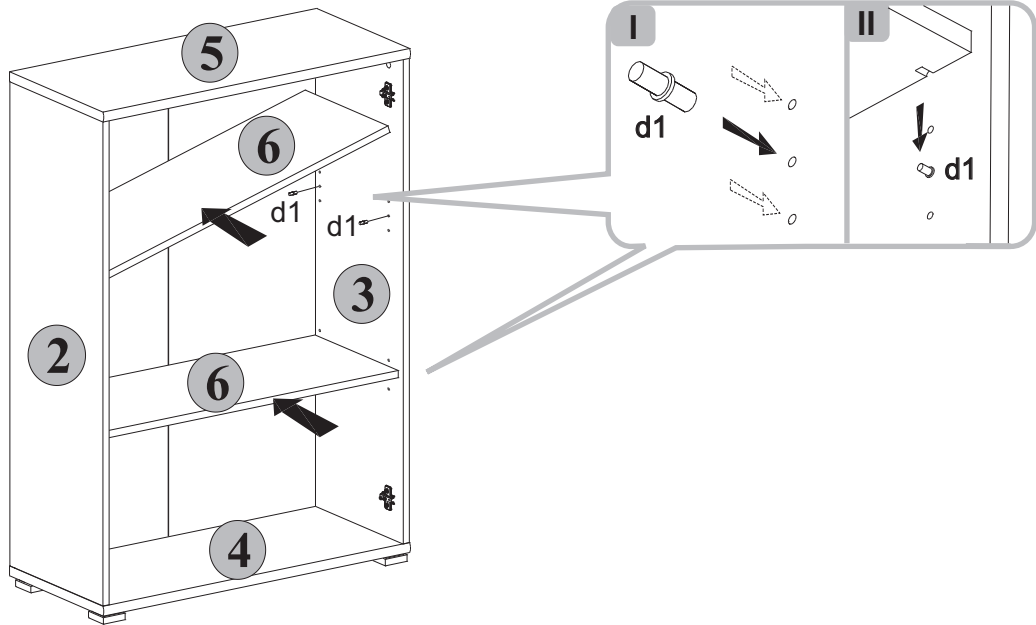

6

