

MCA

furniture

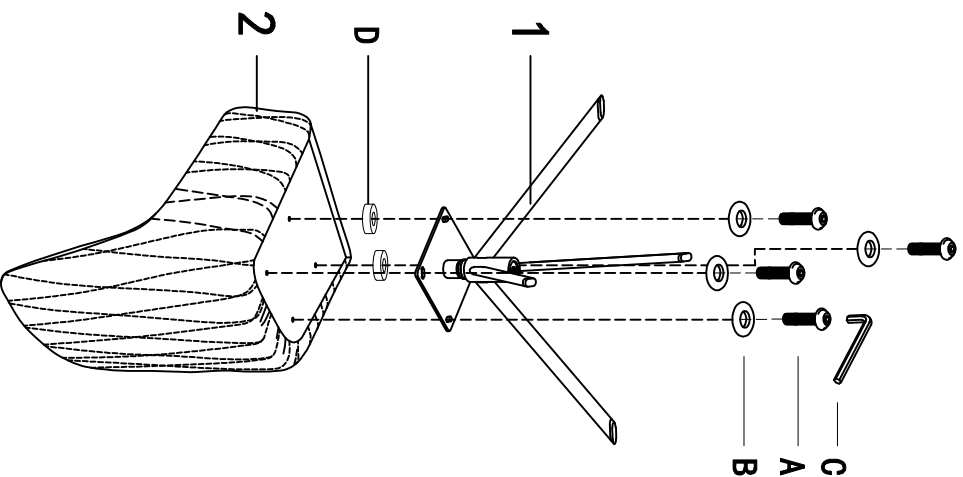



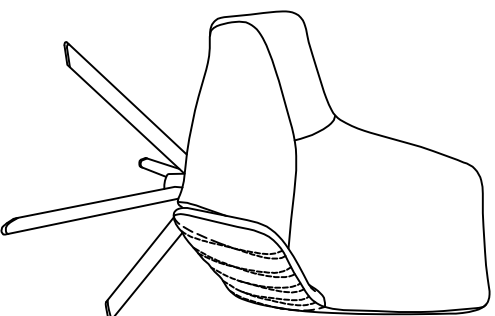

REYNOSA

STEP 1

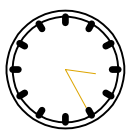

STEP 2



			1		1x
2		A		B	
	1x		M6x20mm		4x
C		D			
	1x		5mm		2x
M5					

D	Bitte überprüfen Sie in regelmäßigen Abständen den festen Sitz der Schrauben!	NL	Controleer op regelmatige afstanden of de schroeven goed vast zitten.
GB	Please check the screws for tightness at regular intervals!	SWE	Kontrollera med jämna mellanrum att skruvarna sitter fast ordentligt!
F	Veillez contrôler régulièrement que les vis sont convenablement serrées !	SK	V pravidelných intervalech kontrolujte pevné dotahnutie skrutek!
ES	¡Compruebe periódicamente que los tornillos estén bien apretados!	SL	Redno preverjajte, ali so vijaki trdno priviti!
IT	Controllare regolarmente che le viti siano ben strette!	NR	Redovito proverjavajte čvrsto nalijeganje vijaka!
PL	Należy regularnie sprawdzać dokręcenie śrub!		

