

Duschpaneel „Laos“ 64732726–33003338

Größe: 975 x 460 mm



**Aufbauanleitung
Duschpaneel**



**Istruzioni d'installazione
Pannello doccia**



**Installations Instructions
Shower panel**



**Montagehandleiding
Douchepaneel**



**Instructions d'installation
Panneau de douche**

D: Nachdruck, auch auszugsweise, nicht gestattet! GB: Reproduction, even in extracts, is not permitted! F: Toute reproduction de ce mode d'emploi même par extraits est interdite ! IT: È vietata la riproduzione, anche parziale. NL: Nadruk, ook slechts gedeeltelijk, niet toegestaan!

Anleitung, Nr.: 20236473272633003338

**WICHTIG, FÜR SPÄTERE BEZUGNAHME DIESES DOKUMENT
AUFBEWAHREN! SORGFÄLTIG LESEN!**

Bestimmungsgemäßer Gebrauch

- Dieser Artikel ist ein Duschpaneel.
- Dieser Artikel ist nur zum Einsatz im privaten Bereich bestimmt.



Sicherheitshinweise

- VORSICHT WASSERSCHADEN!

Stellen Sie bitte vor der Montage die allgemeine Wasserzuführung ab.

- Achten Sie darauf, dass alle Dichtungen den korrekten Sitz haben.
- Dieses Duschpaneel ist nicht für die Verwendung an Niederdruckgeräten und offenen (drucklosen) Elektrokleinspeichern geeignet.
- Duschpaneel zur Verwendung in Privathaushalten! Ausschließlich geeignet zur Verwendung in Räumen mit einer Temperatur über 0 °C, bei Frostgefahr Wasserzufuhr unterbrechen und Duschpaneel entleeren.
- **VORSICHT bei Warmwassereinstellung:** Verbrühungsgefahr!
- Achten Sie darauf, dass keine ätzenden oder korrosiven Mittel, wie z. B. Putzmittel oder Haushaltsreiniger an die Schläuche gelangen, dies kann zu Wasserschäden führen.
- Erstickungs- / Verletzungsgefahr! Lassen Sie Kinder nicht mit der Verpackung spielen. Sie könnten an der Folie ersticken oder sich an der Umverpackung verletzen.
- Achten Sie darauf, dass Kinder keine kleinen Teile, wie z. B. Muttern, Abdeckkappen oder Ähnliches in den Mund nehmen. Sie könnten sie verschlucken und daran ersticken.
- Beschädigungsgefahr! Vor der Montage bitte Montageanleitung genauestens durchlesen und Produkt auf evtl. Transportschäden überprüfen. Gehen Sie bei der Montage des Artikels sorgfältig vor.
- Der Artikel darf nur von fachkundigen Personen montiert werden. Es empfiehlt sich die Montage mit zwei Personen durch zu führen.
- Verletzungsgefahr! Beachten Sie bei der Montage, dass einige Teile scharfe Kanten aufweisen.
- Montieren Sie den Artikel nur an einer geeigneten, massiven Wand.
- Achtung: Die Befestigung des Artikels an der Wand muss von einer fachkundigen Person vorgenommen werden, da für die Montage an die Wand angepasste Dübel erforderlich sind.
- Stellen Sie sicher, dass sich keine Kabel oder Rohrleitungen in den Bohrbereichen befinden.
- Prüfen Sie die Bereiche vor dem Bohren mit einem Metallsuchgerät.
- Bei Ersatzteilbestellung (siehe Teileliste) bitte an den Kundenservice wenden.
- **Teile zur Befestigung sind nicht im Lieferumfang enthalten und im Fachmarkt käuflich zu erwerben.**

Pflegehinweise

Für die Reinigung und Pflege verwenden Sie einen Schwamm oder ein weiches Tuch. Es genügen umwelt-schonende und sanfte Haushaltsreiniger. Verwenden Sie keinesfalls aggressive oder Lösemittel enthaltende Reinigungsmittel. Benutzen Sie zur Reinigung auf keinen Fall scharfe Gegenstände, Stahlwolle, Chemikalien oder sandhaltige Scheuermittel. Diese führen zu einer Beschädigung der Oberfläche und zu einem Verlust der Garantie. Leichte Kalkbeläge lassen sich mühelos mit etwas Haushaltessig entfernen.

Benötigte Werkzeuge

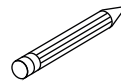
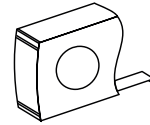
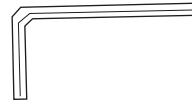
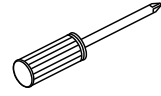
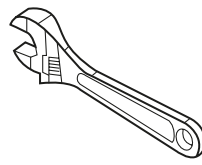
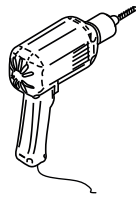
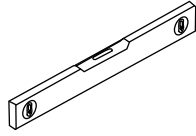
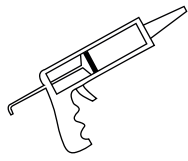

**Aufgrund des hohen Gewichts dieses Produktes
könnte der Aufbau zwei Personen erfordern.**

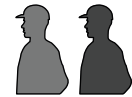

Verpackungsinhalt

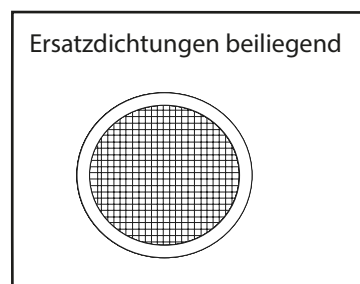
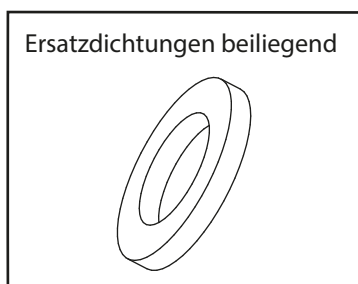
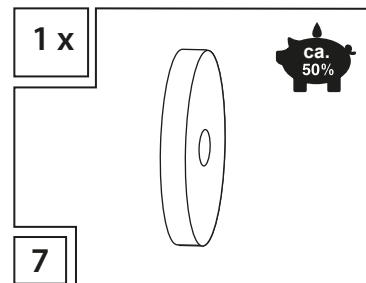
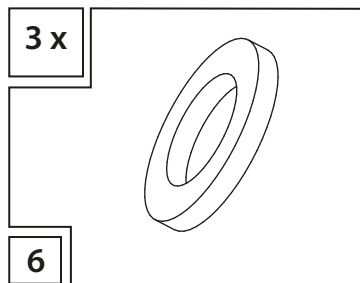
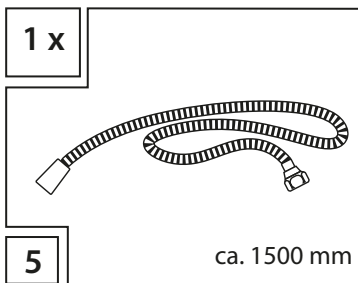
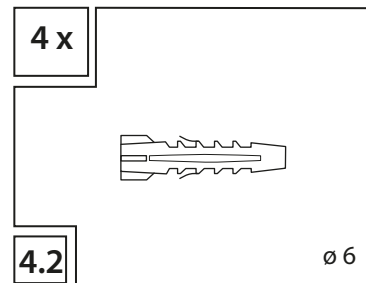
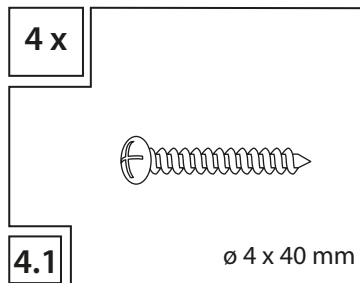
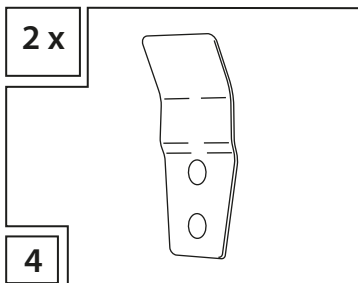
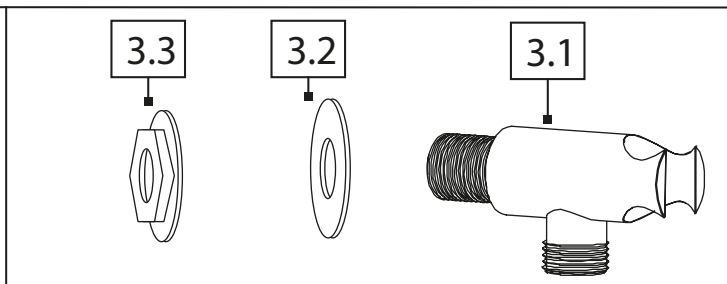
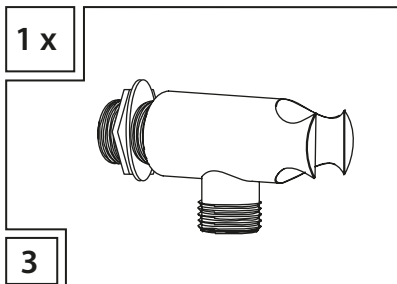
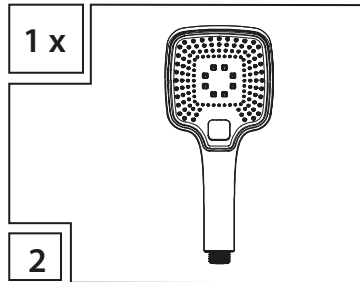
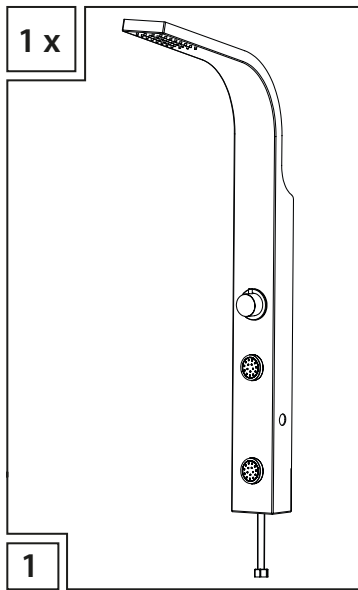

Montagezeichnung

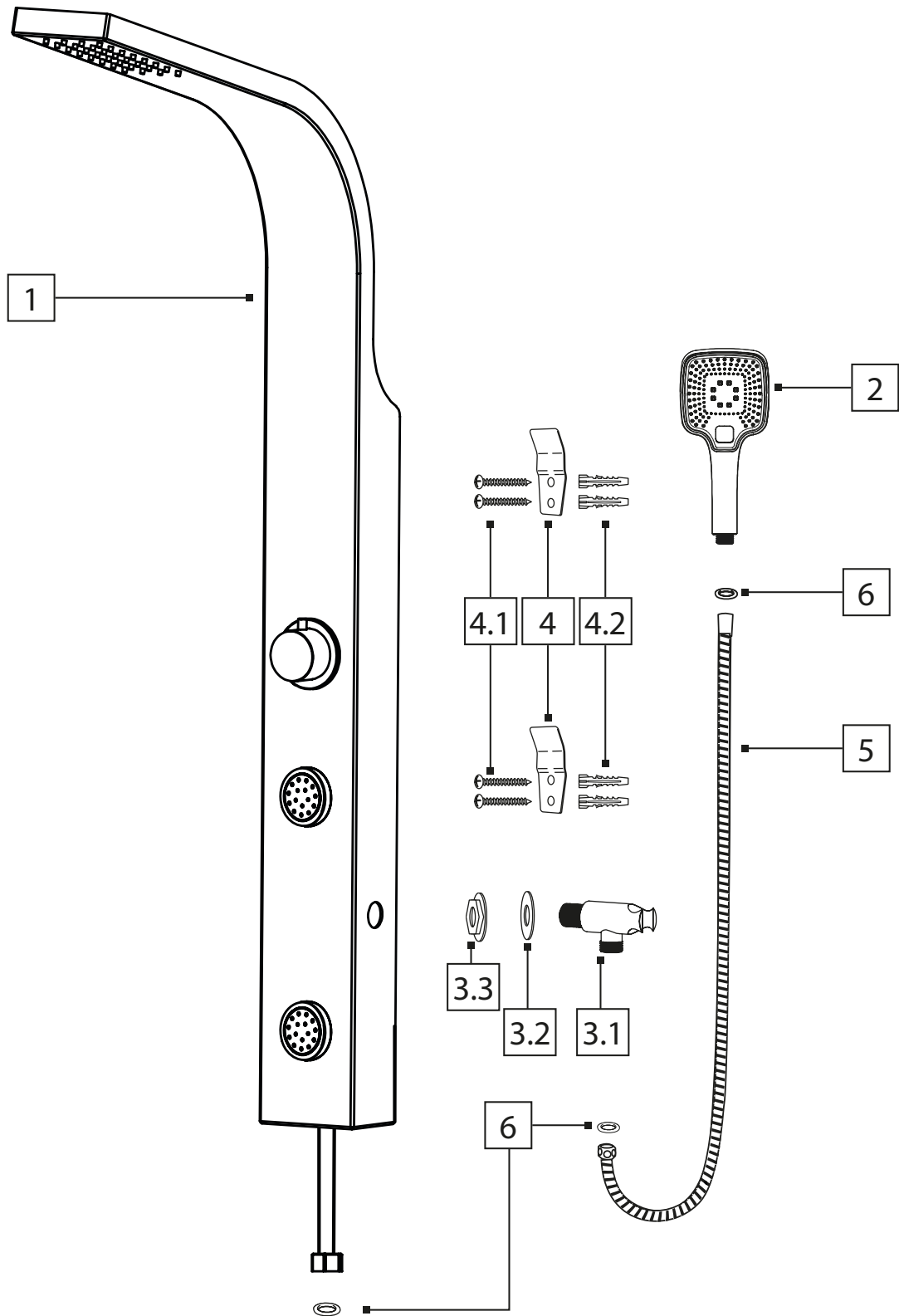

AufbausCHRitte

Unten stehend finden Sie eine Schritt-für-Schritt-Anleitung, wie Sie die Hauptkomponenten des Duschpaneel zusammenbauen.

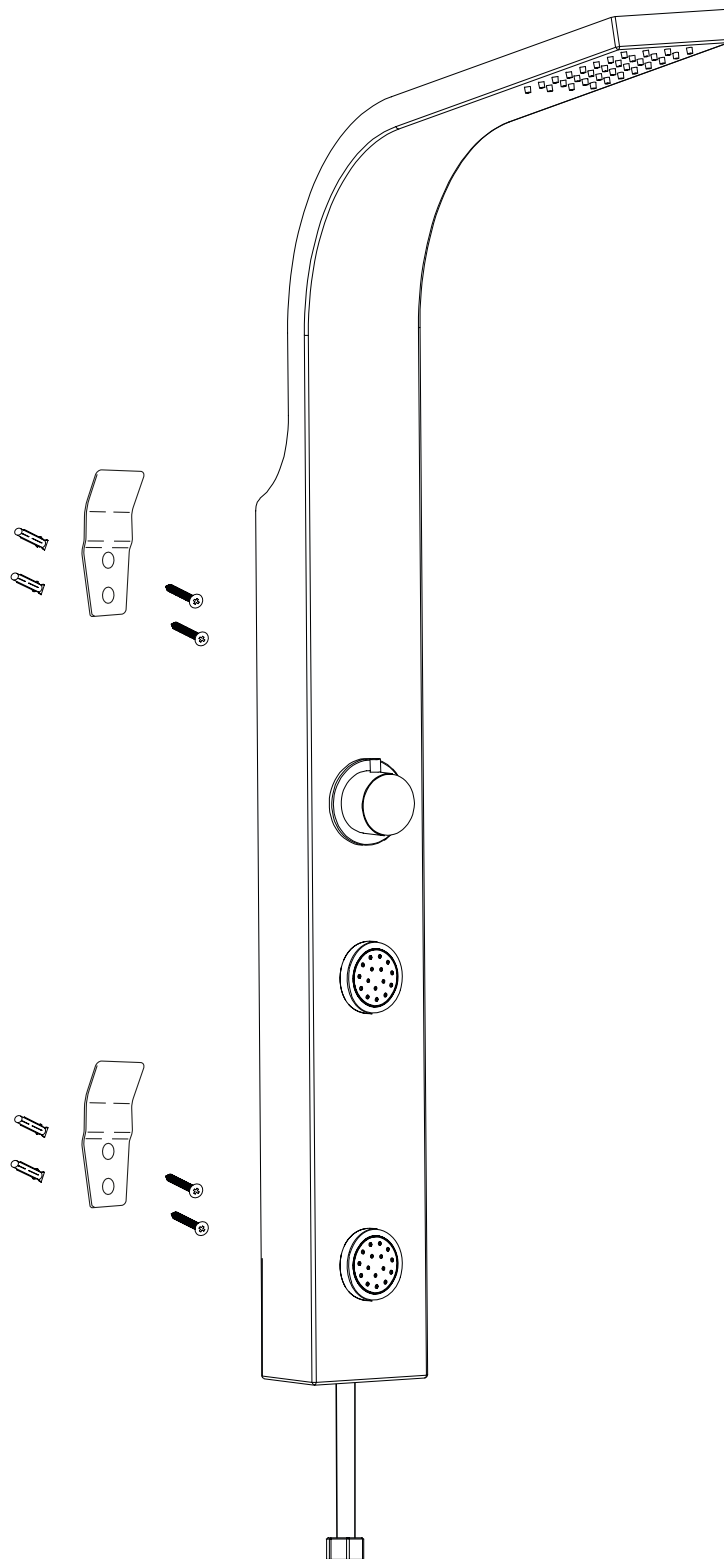

Positionierung der Höhe des Duschsäule für den Benutzer

In Abhängigkeit davon, wie groß Sie sind, empfehlen wir, den Duschkopf etwas 260 mm oberhalb Ihres Kopfes anzubringen. Wenn mehrere Personen in Ihrem Haushalt die Dusche nutzen, messen Sie die Größe der größten Person und bringen den Duschkopf 260 mm oberhalb der gemessenen Höhe an.

Aufbauschritte

Unten stehend finden Sie eine Schritt-für-Schritt-Anleitung, wie Sie die Hauptkomponenten des Duschpaneel zusammenbauen.

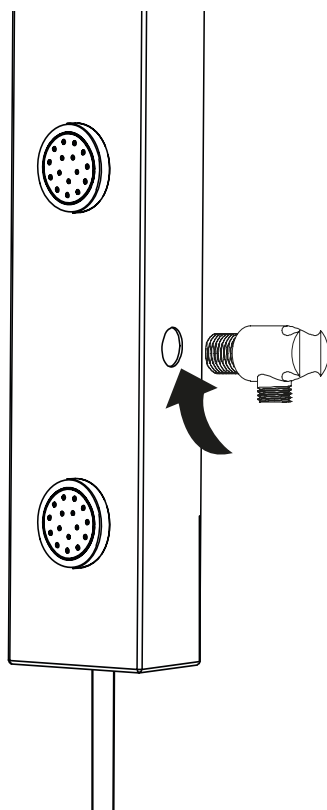
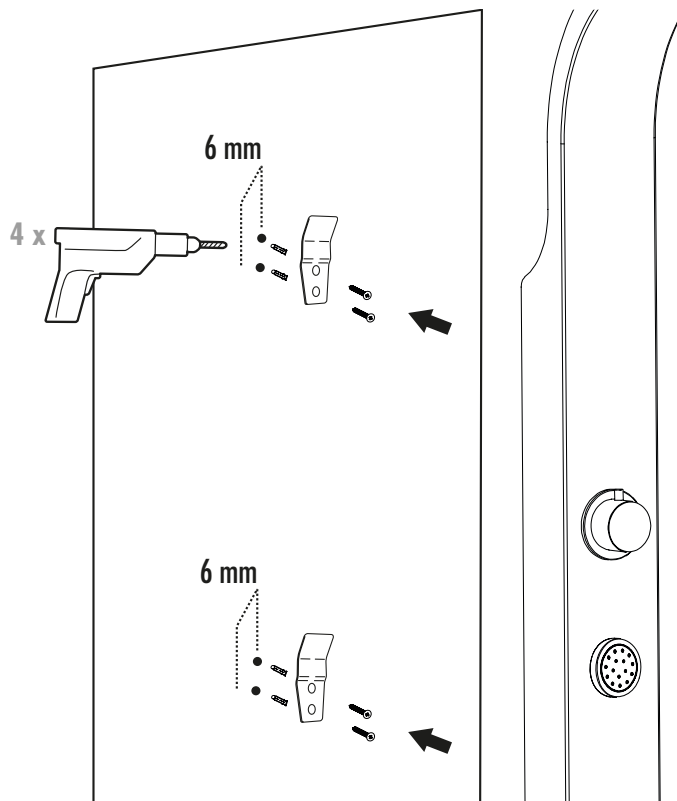

Aufbauschritte

Unten stehend finden Sie eine Schritt-für-Schritt-Anleitung, wie Sie die Hauptkomponenten des Duschpaneel zusammenbauen.

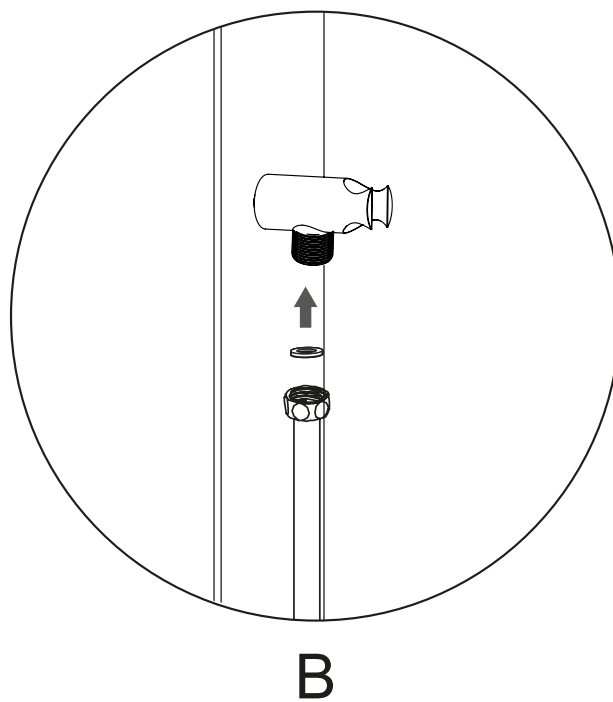
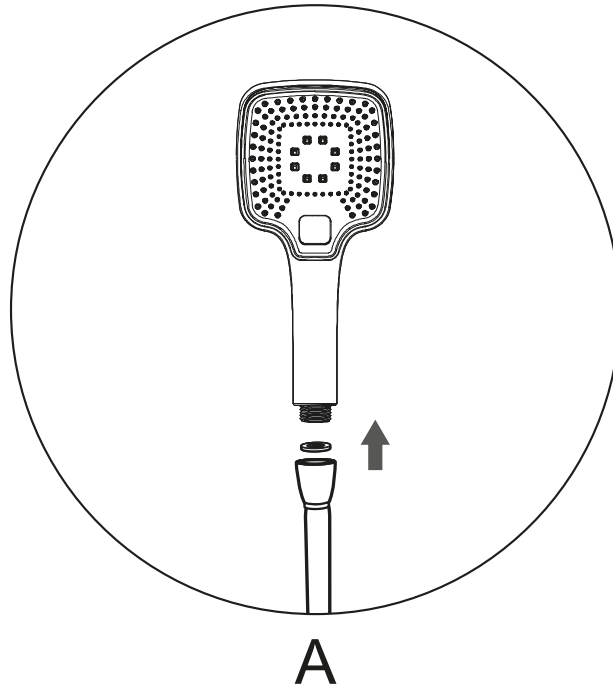

Abmessung

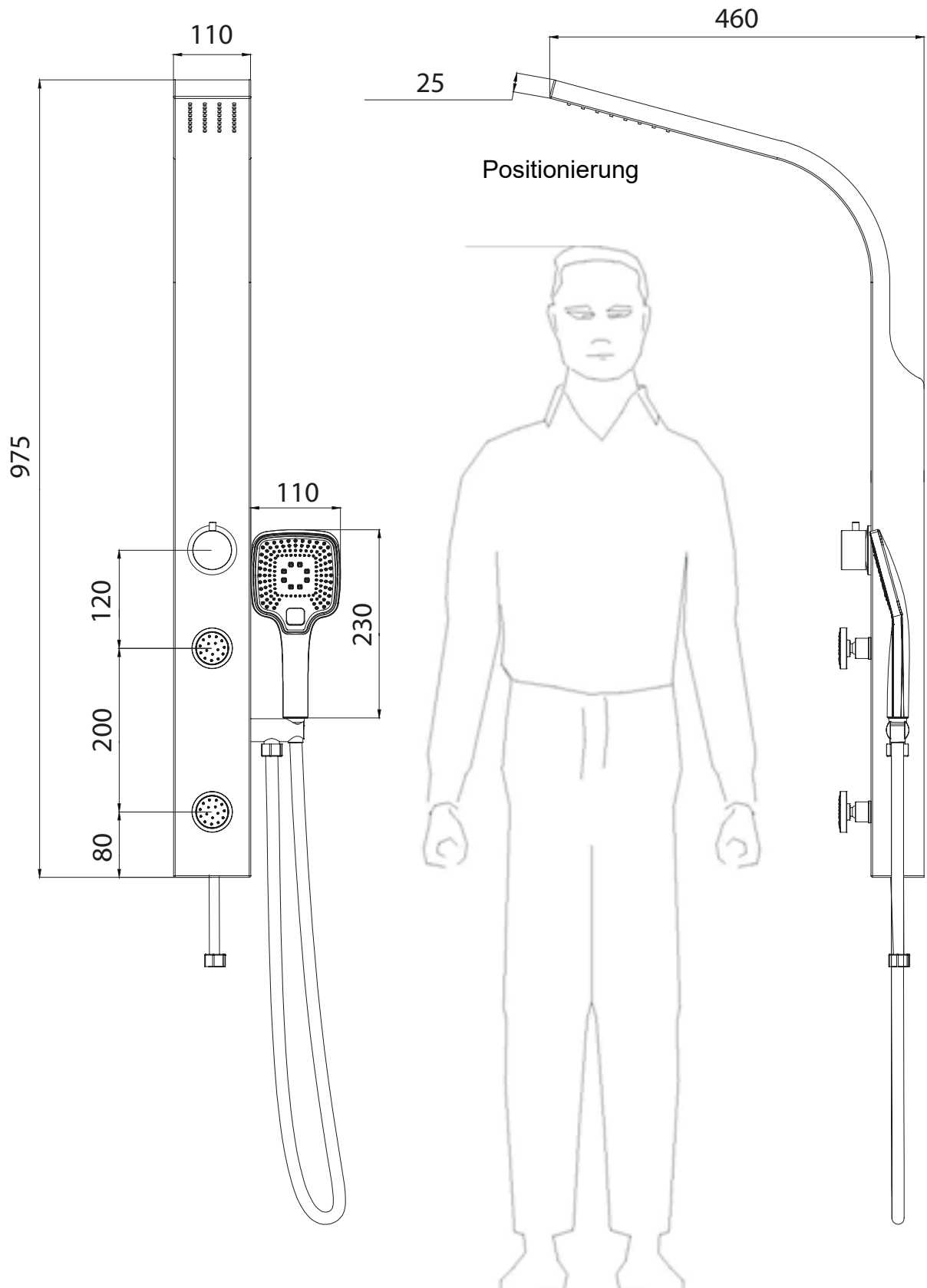

Vorbereitung der richtigen Position Ihres Duschpaneel

1. Verwenden Sie Ihre Körpergröße als Basis für die Festlegung der Position Ihres Duschpaneels (Angaben in mm). Verwenden Sie die Zeichnung, um A und B festzulegen, so dass die richtigen Bohrlöcher zur Installation der Befestigungsklammern angebracht werden können.

Abmessung

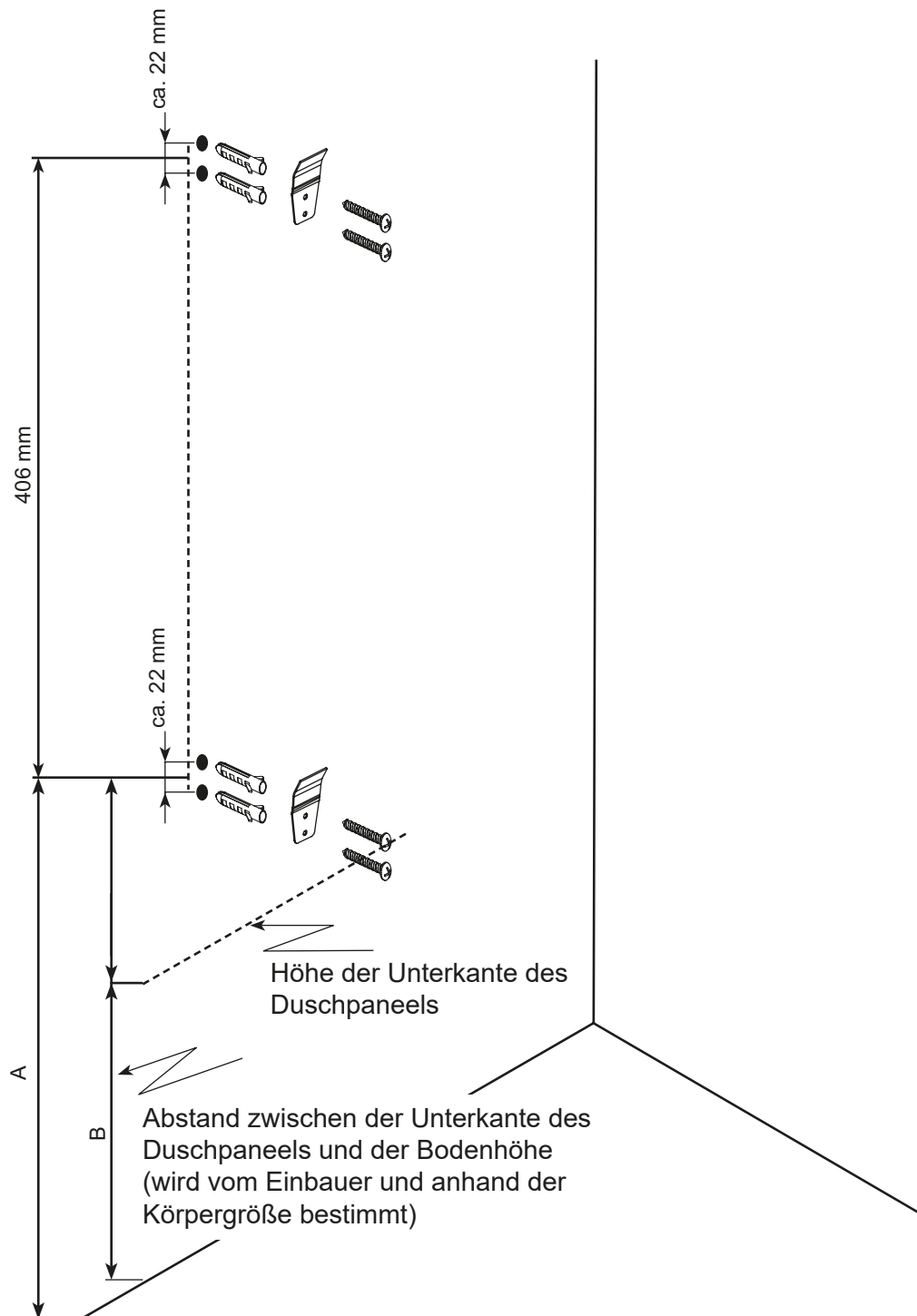

2. Optimale Höhe für den Warm-/Kaltwasserauslass und den Abstand zwischen beiden Wasserhähnen.

3. Verbinden Sie den einen Wassereinfluss-schlauch des Duschpaneels mit einem Schraubenschlüssel mit dem Warm-/Kaltwasserhahn.

Entsorgung

Sollte dieser Artikel einmal nicht mehr benutzt werden können, so ist jeder Verbraucher gesetzlich verpflichtet, Altgeräte getrennt vom Hausmüll zu entsorgen und z.B. bei einer Sammelstelle seiner Gemeinde / Stadtteils abzugeben.

Unser Service

Eine umgehende Fachberatung erhalten Sie von unserem Service-Team:

- **Deutschland:** Telefon 01806-63 06 30, Festnetz 20ct/Anruf, Mobilfunk max. 60 ct/Anruf
- **Österreich, Universal:** Telefon +43 / 662-4485 59, Festnetz je nach Betreiber, Fachberatung Heimwerken – Otto: +43 / 316-606 159 Festnetz je nach Betreiber, Beratung Heimwerken – Quelle: +43 / 662-9005 59 Festnetz je nach Betreiber, Fachberatung Heimwerken
- **Schweiz,** Quelle: **DE:** +41 / 848 85 85 00, **FR:** +41 / 848 85 85 01, **I:** +41 / 848 858 530
- **Ackermann: DE:** +41 / 848 85 85 11, **FR:** +41 / 848 85 85 21, **I:** +41 / 848 858 530
- **Niederlande,** call center 0900-1901 (15ct/Min.)

Um Ihnen schnell helfen zu können, nennen Sie uns bitte:

Artikelbezeichnung: Duschpaneel „Laos“ 64732726–33003338
und die **Artikelnummer** unter der Sie den Artikel bestellt haben (siehe Rechnung).

Imported by Franz Joseph Schütte GmbH, Hullerweg 1, 49134 Wallenhorst (Germany)

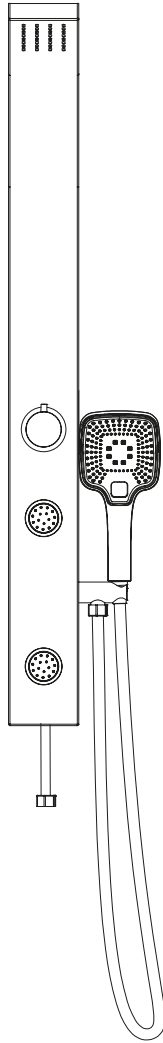

Shower panel „Laos“

64732726–33003338

Size: 975 x 460 mm



Aufbauanleitung
Duschpaneel



Istruzioni d'installazione
Pannello doccia



Installations Instructions
Shower panel



Montagehandleiding
Douchepaneel



Instructions d'installation
Panneau de douche

D: Nachdruck, auch auszugsweise, nicht gestattet! GB: Reproduction, even in extracts, is not permitted! F: Toute reproduction de ce mode d'emploi même par extraits est interdite ! IT: È vietata la riproduzione, anche parziale. NL: Nadruk, ook slechts gedeeltelijk, niet toegestaan!

Anleitung, Nr.: 20236473272633003338

IMPORTANT: PLEASE KEEP THIS DOCUMENT FOR LATER
REFERENCE! READ CAREFULLY!

Indented use

- This article is a Shower panel.
- This product is intended for use in private spheres only.



Safety instructions

- CAUTION DAMAGE BY WATER!

- Prior to installation please turn the general water supply off.
- Ensure that all gaskets have the correct fit.
- This Shower panel are not suitable for use on low pressure and small electrical storage heaters.
- Shower panel is only intended for use in private households! Only suitable for use in rooms with a temperature over 0 °C, when there is danger of frost, shut off the water supply and empty the Shower panel.
- Take care when adjusting the warm water. Danger of scalding!
- Please ensure that no caustic or corrosive products such as detergents or household cleaning products make contact with the connection hoses; this can lead to water damages.
- Choking hazard / danger of injury! Do not let children play with the packaging. They might suffocate by the wrapping or injure themselves with the packaging cover.
- Make sure that children do not take small parts such as nuts, cover caps or the like into their mouths. They could swallow these and choke on them.
- Risk of damage! Please read the assembly instructions very carefully prior to assembling and check the product for possible transportation damage. Be careful during the product's assembly.
- The product must only be installed by competent persons. The assembly is recommended to be conducted by two people.
- Danger of injury! During the assembly, please consider that some parts have sharp edges.
- Fix product to suitable and solid walls only.
- **Caution:** The wall fixture of the article must be carried out by a competent person because it requires customized plugs.
- Make sure that there are no wires or pipelines in the drilling ranges.
- Check the areas with a metal detector prior to drilling.
- To order spare parts (see part's list), please contact the customer service.
- **Installation accessories are not included and need to be purchased from a specialist retailer.**

Maintenance instructions

Use a sponge or a soft cloth for cleaning and care. Environmentally friendly and gentle cleaning agents suffice. By no means use any aggressive liquids or cleaning agents containing solvents. Never use sharp objects, steel wool, chemicals or sandy scouring agents for cleaning. These lead to surface damage and loss of warranty. Slight lime deposits are easily removed with some household vinegar.

Tools required

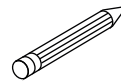
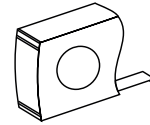
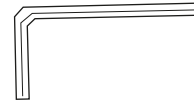
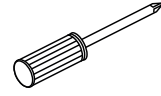
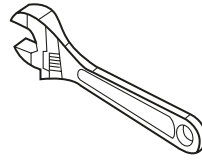
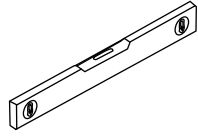
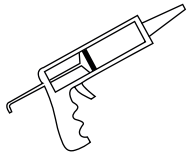

This product is heavy and may require two people to install.



Box contents

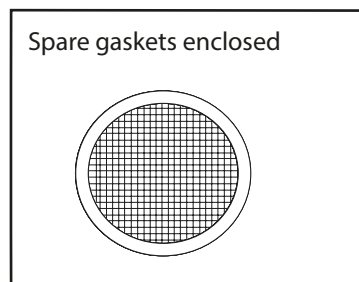
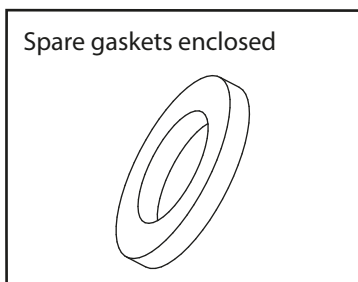
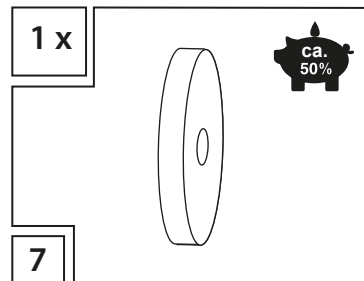
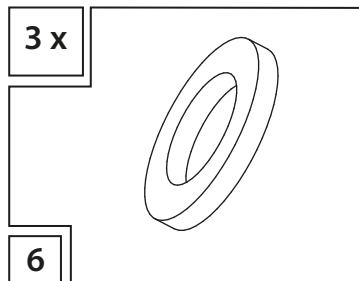
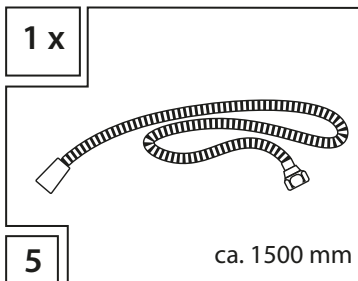
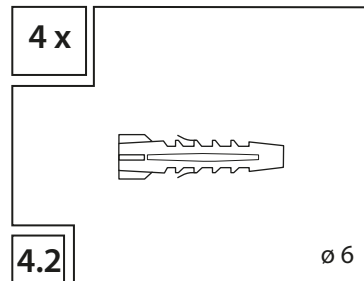
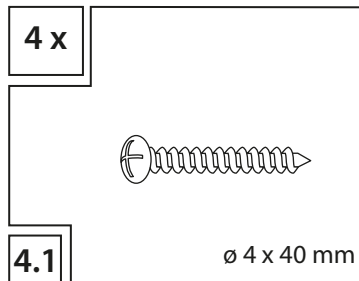
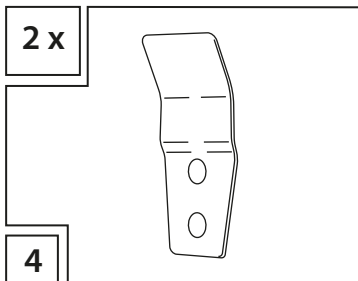
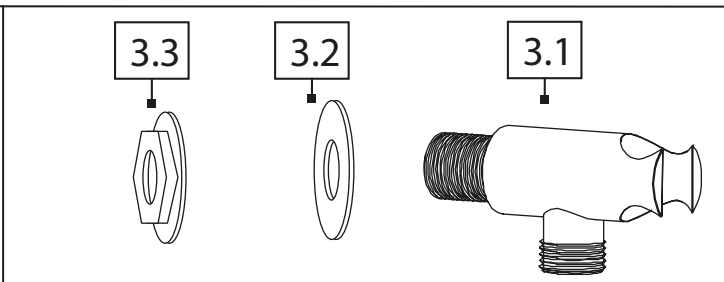
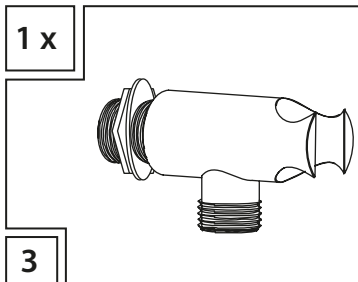
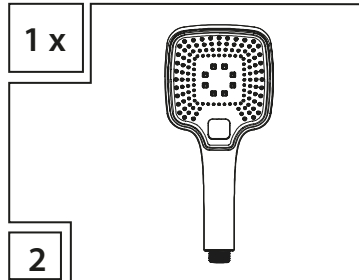
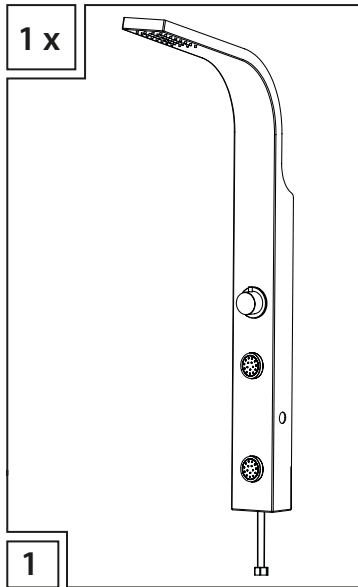

Assembly drawing

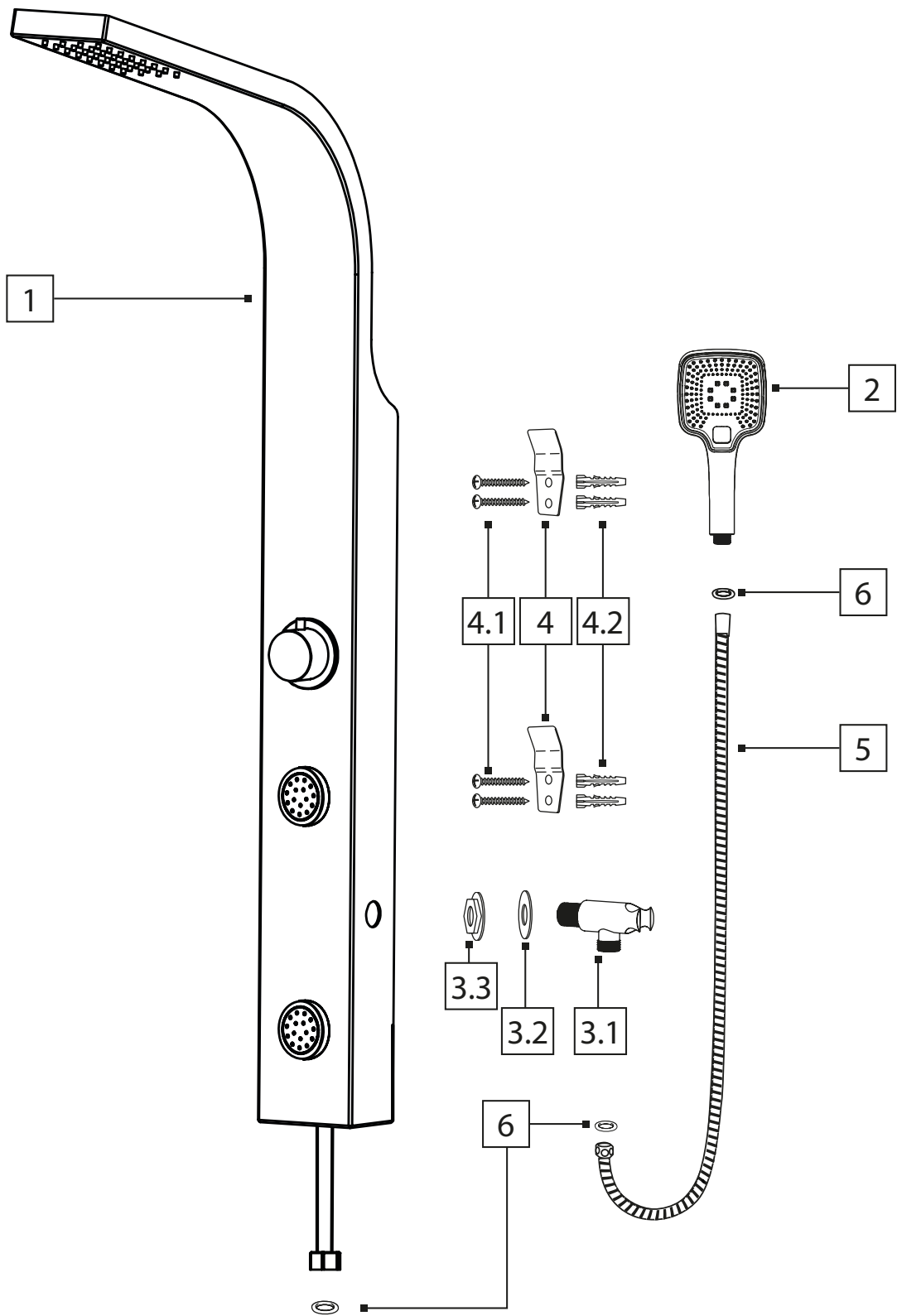

Installation steps

Below is a visual step-by-step sequence of how to put the Shower panel main components together.

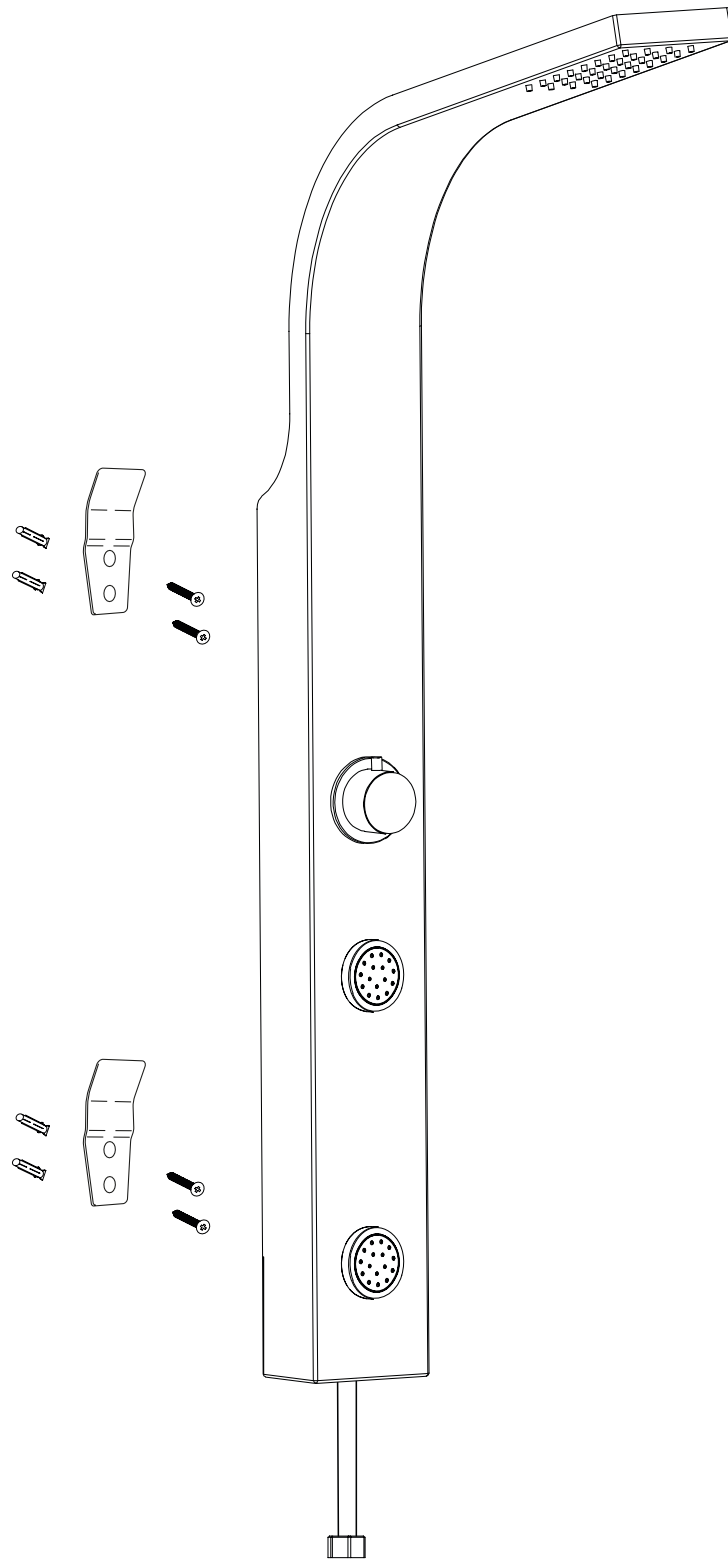

Positioning the Shower panel using user's height

Depending on your height, we recommend the shower head to be positioned approx. 260 mm above your head.

If you have several persons in your home who will be using this Shower panel, measure the height of the tallest person and position the shower head 260mm over that height.

Installation steps

Below is a visual step-by-step sequence of how to put the Shower panel main components together.

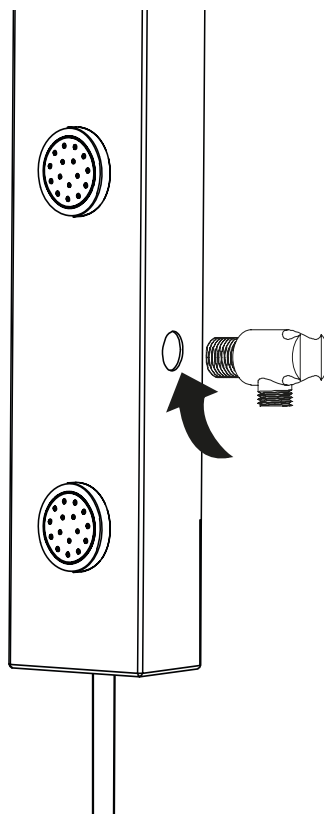
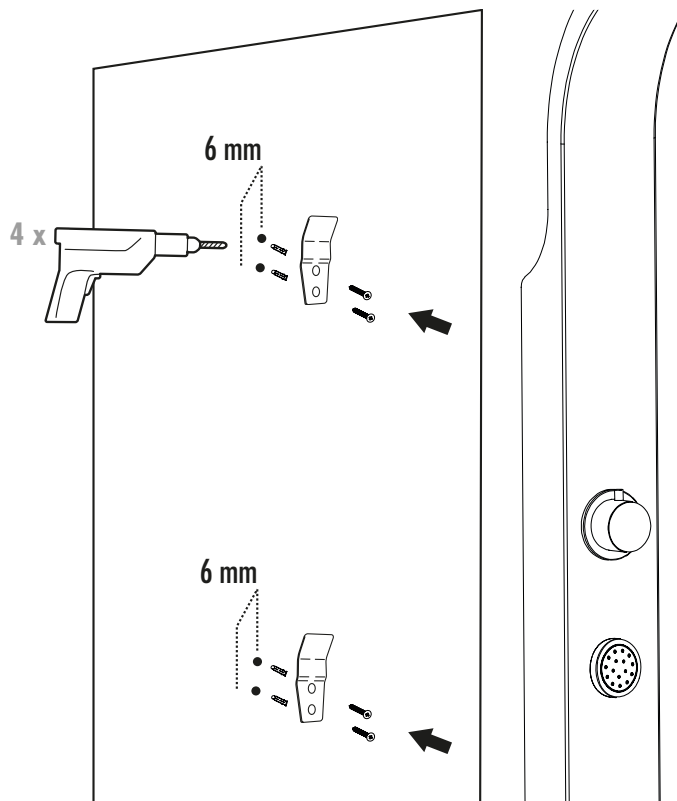

Installation steps

Below is a visual step-by-step sequence of how to put the Shower panel main components together.

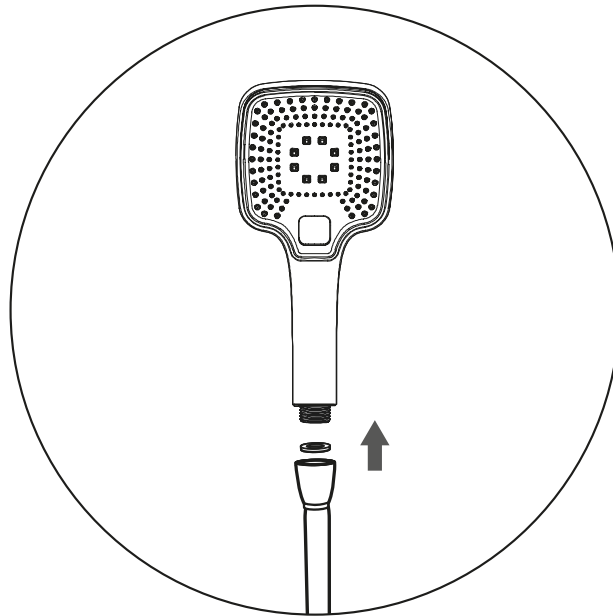

A

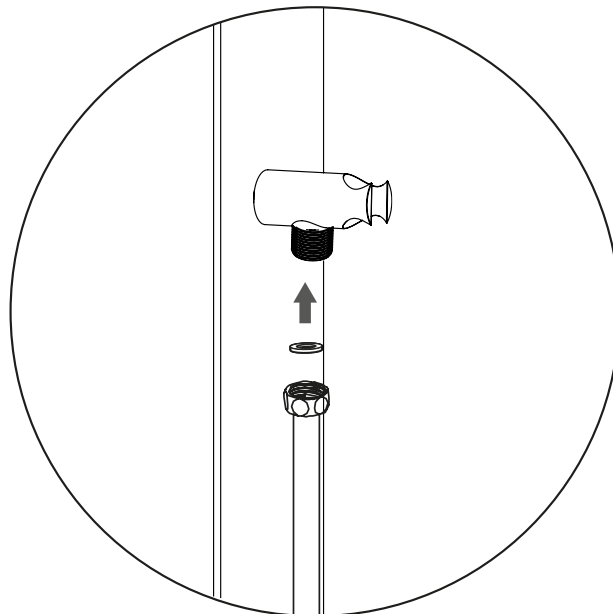

B

Dimensions

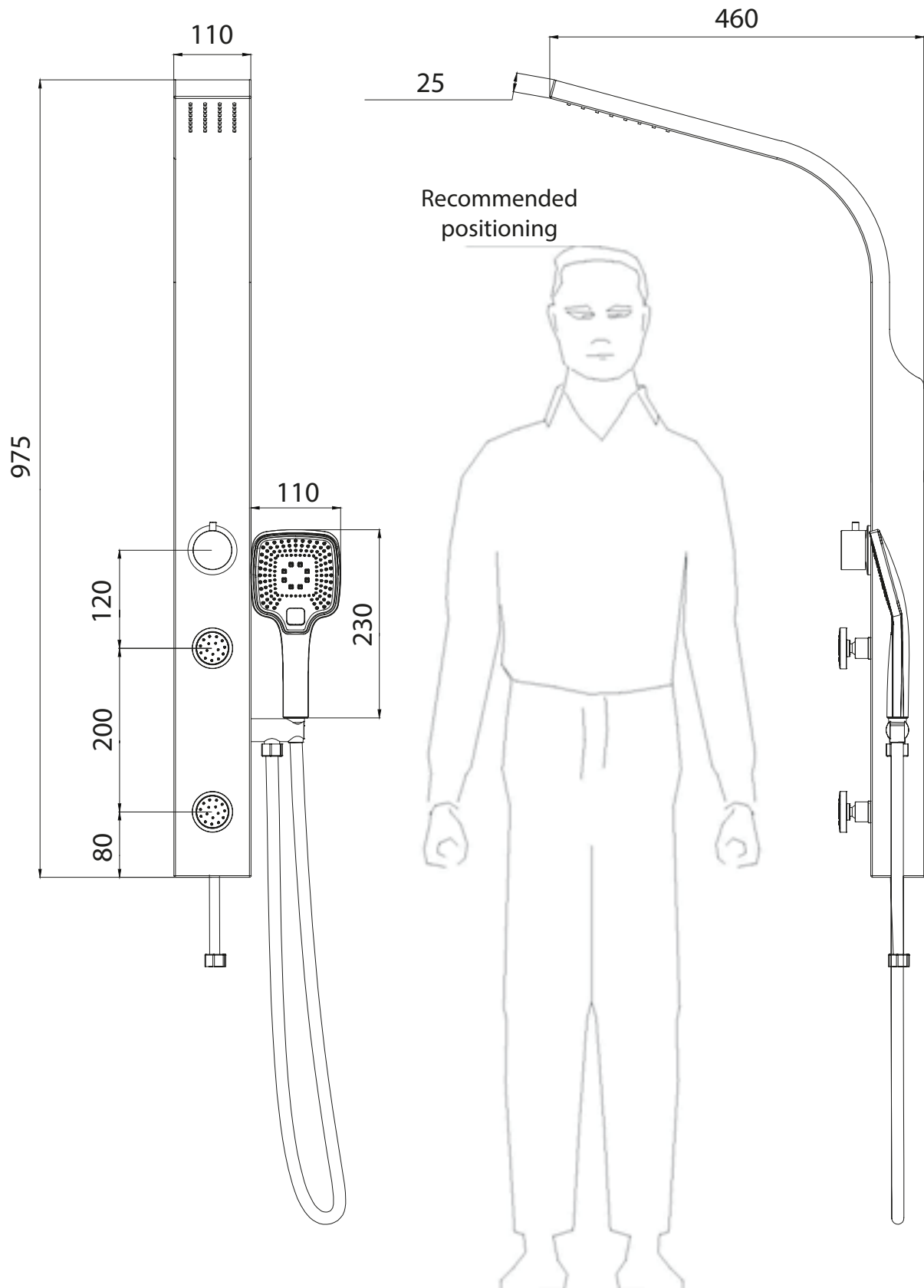

Preparing the proper position for your Shower panel

1. Using your Body Height as a basis for determining the position of your Shower panel, you're your height in mm. Use the drawing to measure A and B in order to determine correct drilling points to install the Positioning and Support Brackets.

Dimensions

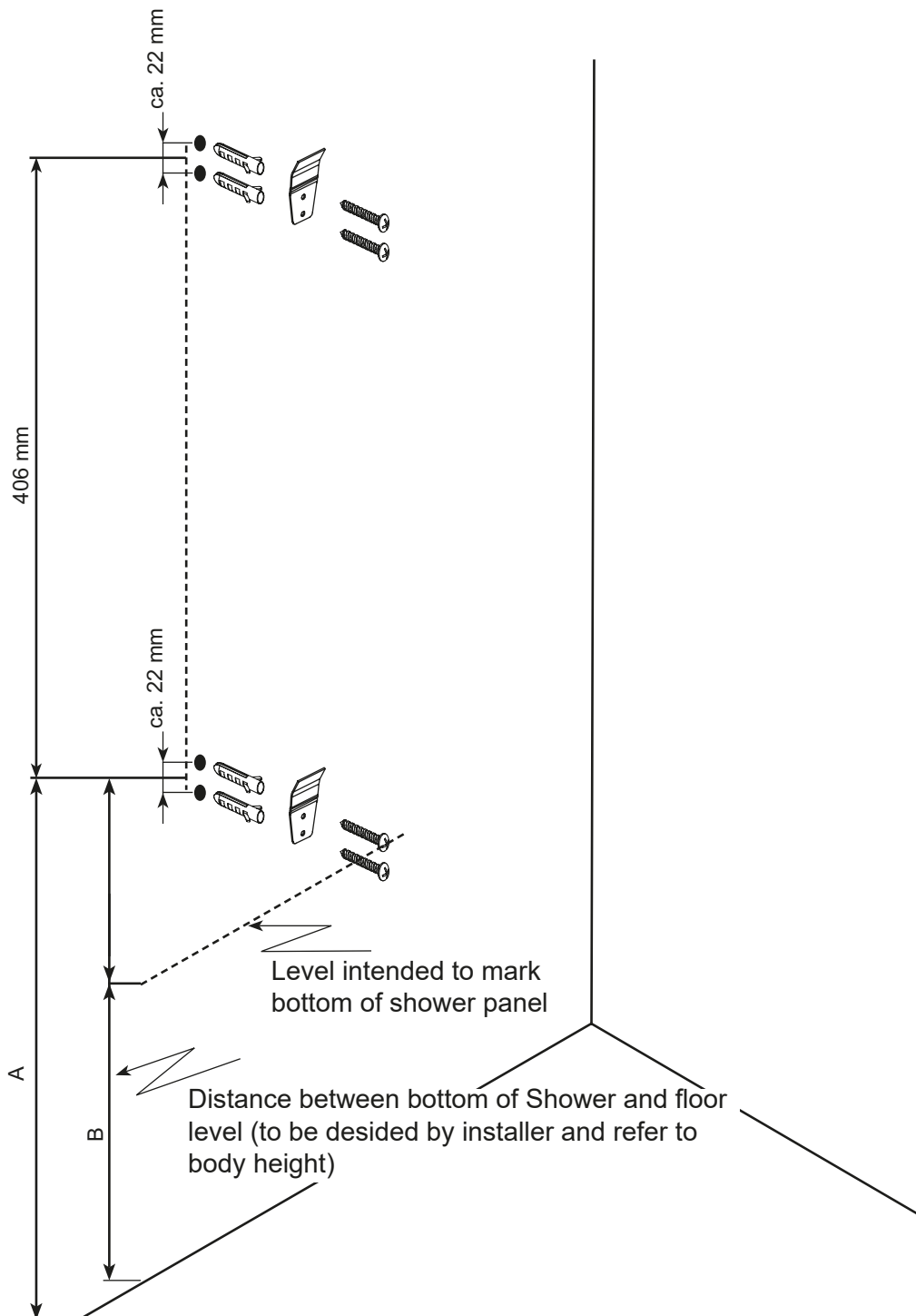

2. This shows the ideal height of the hot/cold water output as well as distance between both taps.

3. Connect the water input hose at the Shower panel to the hot/cold water output tap.

Disposal

Should the product no longer be serviceable, every consumer has a statutory obligation to dispose of old appliances separately from domestic waste and dispose of them e.g. at a local authority / district collection point.

Our service

You will receive prompt professional advice from our service team:

- **Germany:** Telephone 01806-63 06 30, Land line 20ct/call, mobile telephone connection 60ct/call max.
- **Austria, Universal:** Telephone +43 / 662-4485 59 landline depending on provider,
Home improvement expert service - Otto: +43 / 316-606 159 landline depending on provider,
Home improvement expert service - Quelle: +43 / 662-9005 59 landline depending on provider,
Home improvement expert service
- **Switzerland, Quelle:** **DE:** +41 / 848 85 85 00, **FR:** +41 / 848 85 85 01, **I:** +41 / 848 858 530
Ackermann: **DE:** +41 / 848 85 85 11, **FR:** +41 / 848 85 85 21, **I:** +41 / 848 858 530
- **The Netherlands:** call center 0900-1901 (15ct/min.)

In order to assist you more efficiently, please tell us the:

product designation: Shower panel „Laos“ 64732726–33003338
and **item number** you used to order the item (see invoice).

Imported by Franz Joseph Schütte GmbH, Hullerweg 1, 49134 Wallenhorst (Germany)

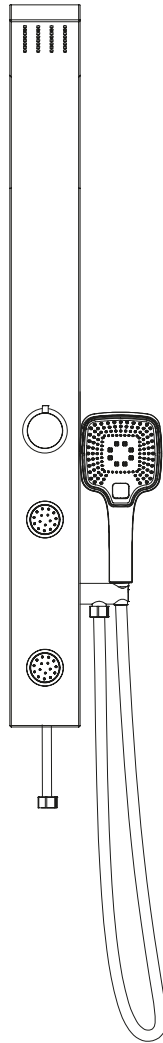

Panneau de douche „Laos“

64732726–33003338

Taille: 975 x 460 mm



Aufbauanleitung
Duschpaneel



Istruzioni d'installazione
Pannello doccia



Installations Instructions
Shower panel



Montagehandleiding
Docuhepaneel



Instructions d'installation
Panneau de douche

D: Nachdruck, auch auszugsweise, nicht gestattet! GB: Reproduction, even in extracts, is not permitted! F: Toute reproduction de ce mode d'emploi même par extraits est interdite ! IT: È vietata la riproduzione, anche parziale. NL: Nadruk, ook slechts gedeeltelijk, niet toegestaan!

Anleitung, Nr.: 20236473272633003338

IMPORTANT, CONSERVER CE DOCUMENT POUR TOUTE RÉFÉ-
RENCE ULTÉRIEURE ! À LIRE ATTENTIVEMENT !

Utilisation conforme à la destination

- Cet article est un Panneau de douche.
- Cet article n'est destiné qu'à un usage de type privé.



Avis de sécurité

- RISQUE DE DÉGÂTS DES EAUX !

Veillez couper l'alimentation générale en eau avant le montage.

- Vérifiez que tous les joints sont correctement positionnés.
- Ce Panneau de douche ne sont pas conçues pour l'utilisation sur des petites ballons électriques ou à basse pression.
- Panneau de douche à usage privé ! Uniquement conçue pour l'utilisation dans les pièces où la température est supérieure à 0 °C. En cas de risque de gel, coupez l'alimentation en eau et videz panneau de douche.
- **Attention** en cas de réglage de l'eau chaude : risque de brûlure !
- Assurez-vous qu'aucun fluide irritant ou corrosif, par ex. un produit de nettoyage ou un nettoyant ménager, ne s'écoule dans les tuyaux de raccordement, ce qui pourrait entraîner des dégâts des eaux.
- Risque d'étouffement / de blessure ! Ne laissez pas les enfants jouer avec l'emballage car ils pourraient s'étouffer avec le film ou se blesser avec les matériaux d'emballage.
- Veillez à ce que les enfants ne portent pas à la bouche de petits éléments comme les écrous, rondelles de couverture ou autres. Ils pourraient les avaler et s'étouffer avec.
- Risque de dégradations ! Avant le montage, merci de lire très attentivement les instructions de montage et de vérifier que le produit n'a pas été endommagé au cours du transport. Merci de procéder au montage de l'article avec de grandes précautions.
- L'article ne peut être assemblé que par du personnel compétent. Il est conseillé de procéder au montage à deux personnes.
- Risque de blessure ! Lors du montage, prenez en compte le fait que cet article présente plusieurs arêtes vives.
- Ne montez l'article que contre des murs massifs et adaptés.
- **Attention:** La fixation des éléments de mobilier au mur doit être effectuée par du personnel compétent, car des chevilles adaptées au mur sont nécessaires pour le montage.
- Assurez-vous qu'aucun câble ou tuyau ne se trouve dans les zones de perçage.
- Avant le perçage, inspectez les zones avec un détecteur de métaux.
- Merci de contacter le service clientèle pour toute commande de pièces détachées (voir la liste des pièces).
- **Les pièces servant à la fixation ne sont pas fournies. Celles-ci sont en vente dans les magasins spécialisés.**

Instructions d'entretien

Pour le nettoyage et l'entretien, utilisez une éponge ou un chiffon doux. Un nettoyant ménager doux et respectueux de l'environnement suffit. N'utilisez jamais de produits de nettoyage agressifs ou contenant des solvants. Pour le nettoyage, n'utilisez jamais d'objets pointus, de laine métallique, de produits chimiques ou de produits à récurer contenant du sable. Ils entraîneront une dégradation de la surface et une privation de la garantie. Les dépôts légers de calcaire peuvent être éliminés sans efforts avec un peu de vinaigre de cuisine.

Outils nécessaires

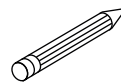
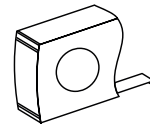
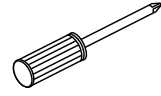
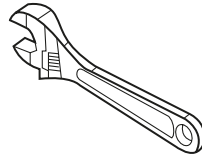
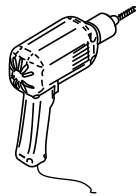
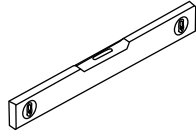
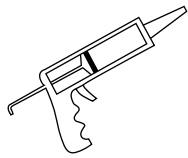

**En raison du poids important de ce produit,
le montage peut nécessiter deux personnes.**



Contenu de l'emballage

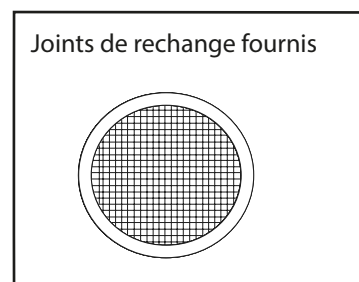
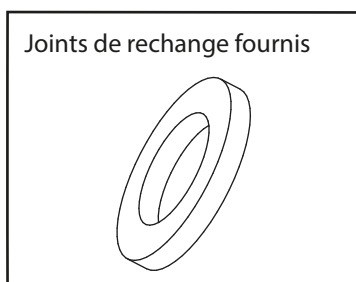
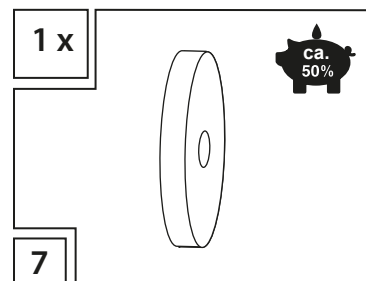
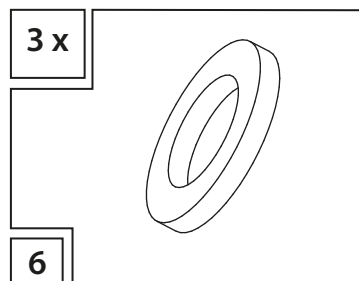
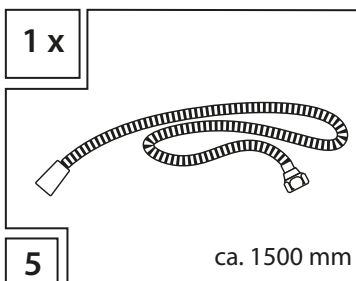
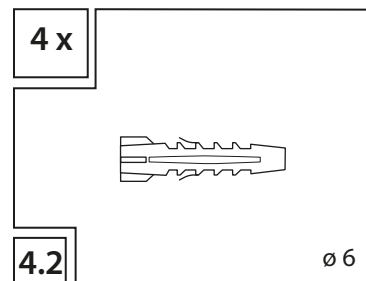
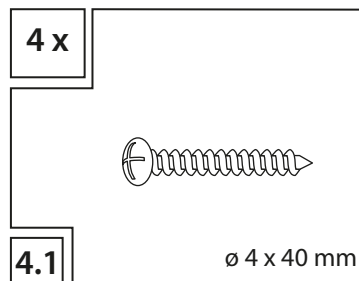
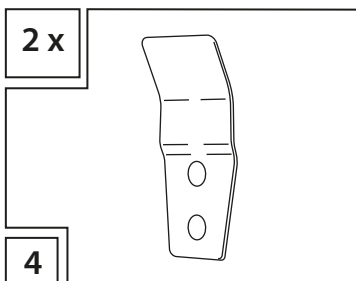
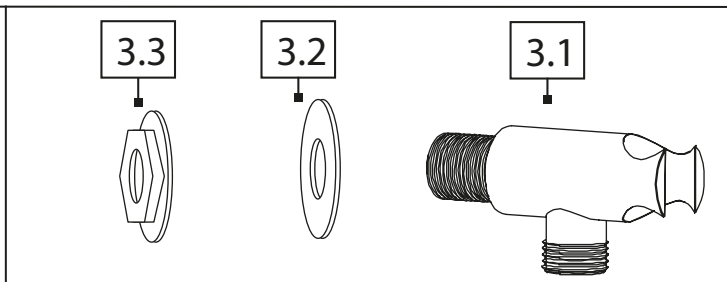
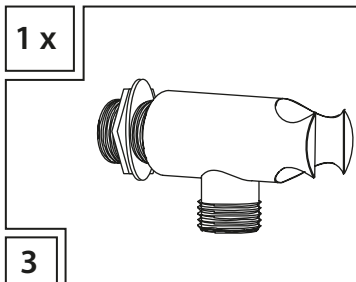
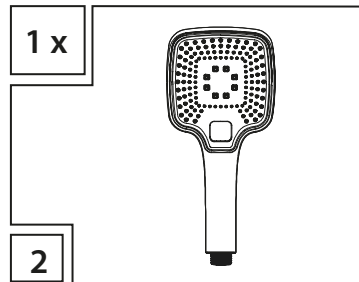
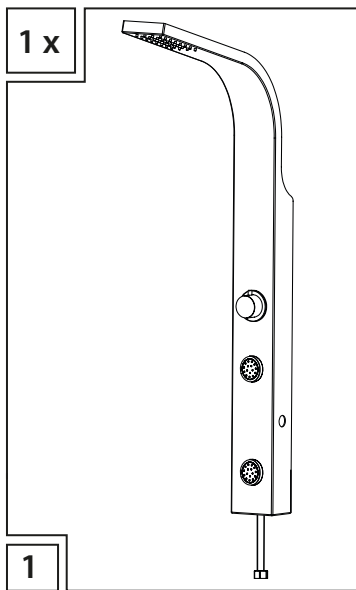

Dessin d'assemblage

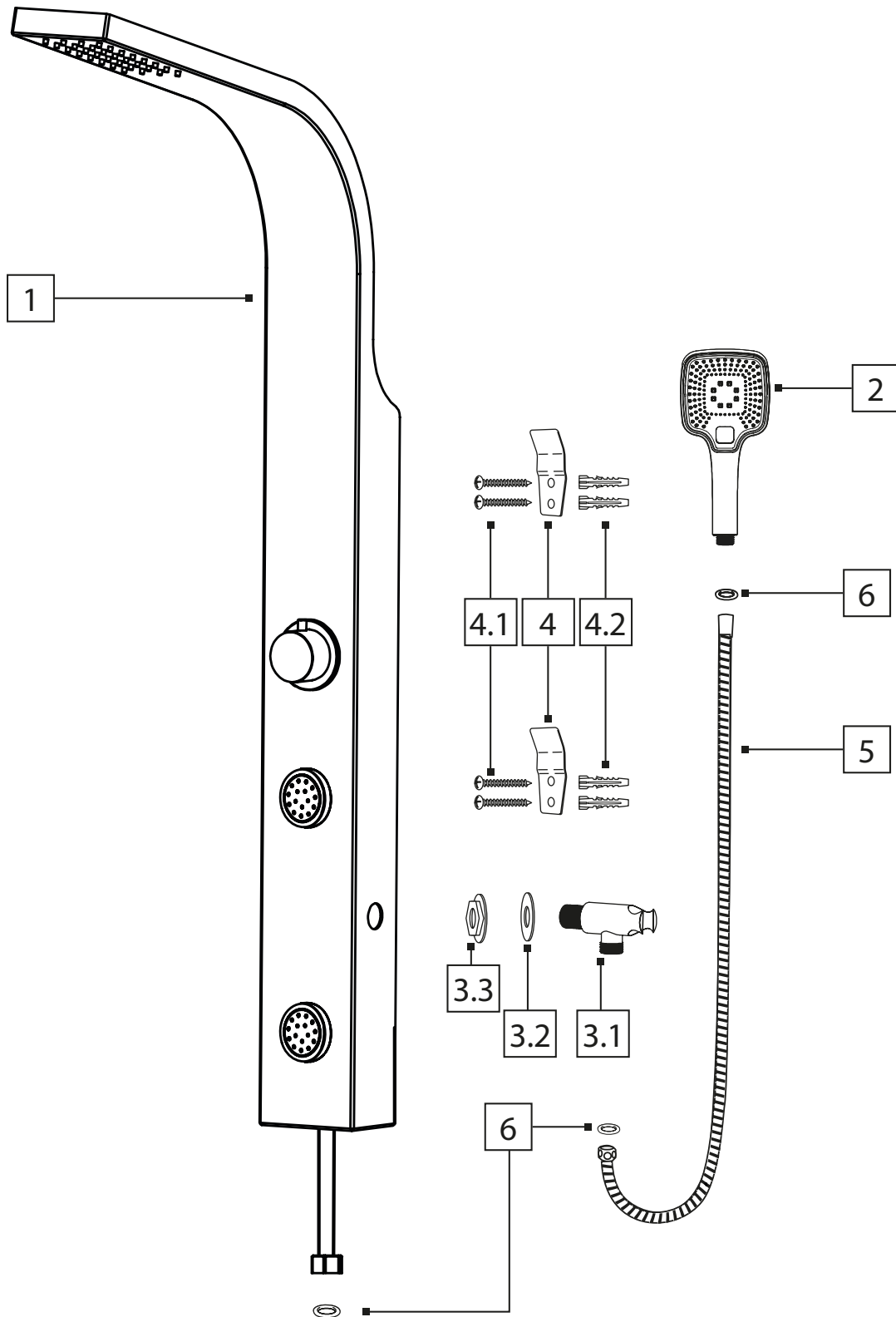

Étapes de construction

Vous trouverez ci-après une instruction étape par étape concernant le montage des principales pièces du panneau de douche.

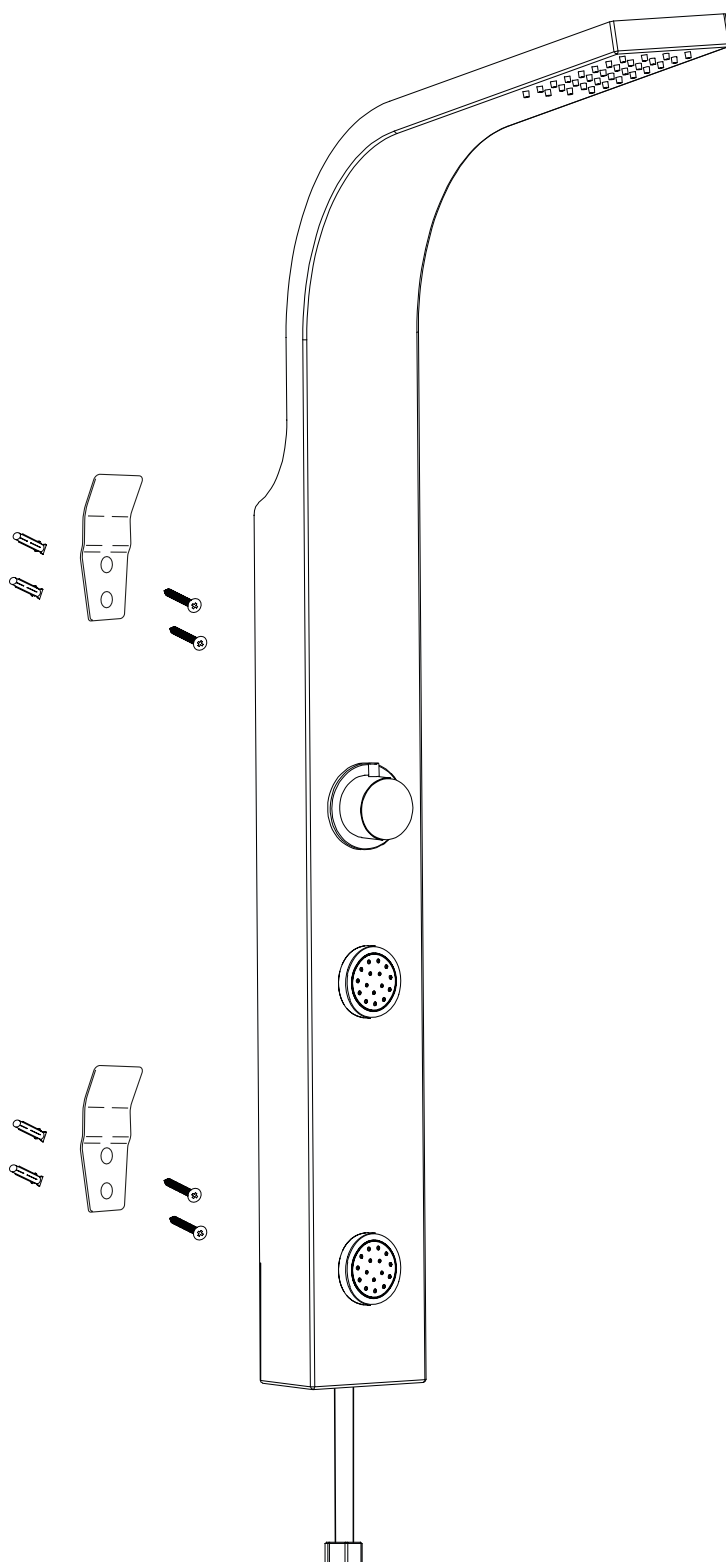

Ajustement du Panneau de douche d'après la taille corporelle

En fonction de la taille corporelle, il est recommandé de placer la tête de douche à une distance d'env. 260 mm au-dessus de votre tête. Si plusieurs personnes veulent utiliser le panneau de douche dans votre foyer, mesurez la personne la plus grande et positionnez la tête de douche 260 mm au-dessus de cette taille.

Étapes de construction

Vous trouverez ci-après une instruction étape par étape concernant le montage des principales pièces du panneau de douche.

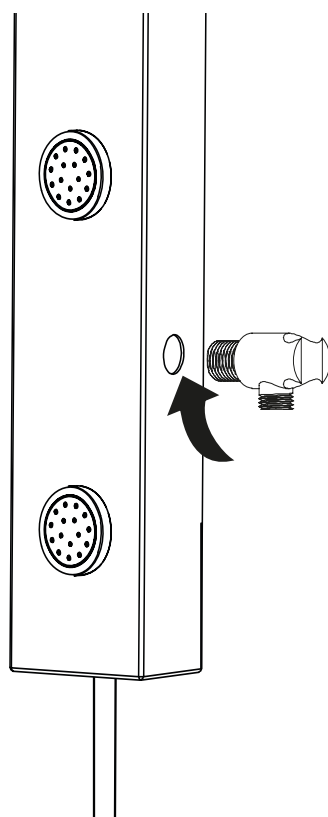
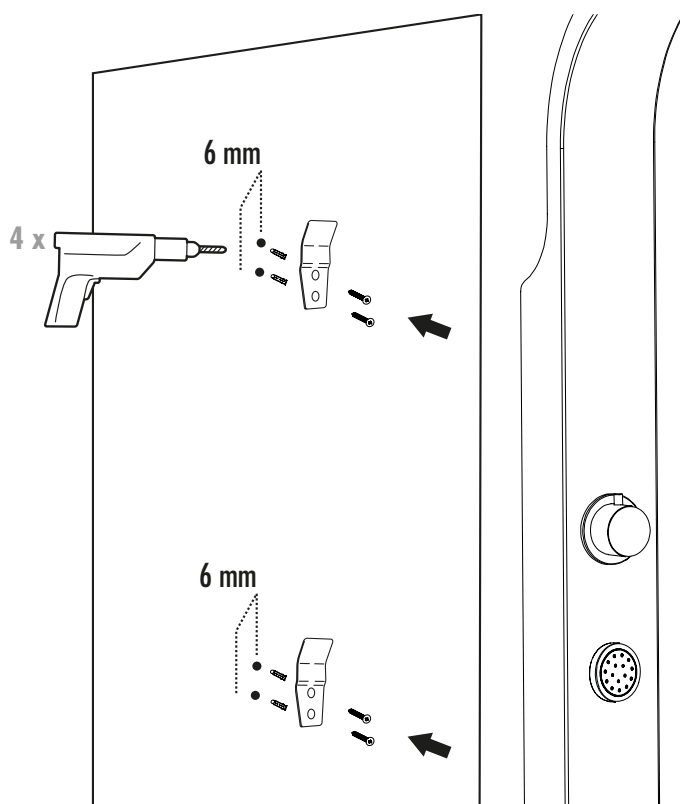

Étapes de construction

Vous trouverez ci-après une instruction étape par étape concernant le montage des principales pièces du Panneau de douche.

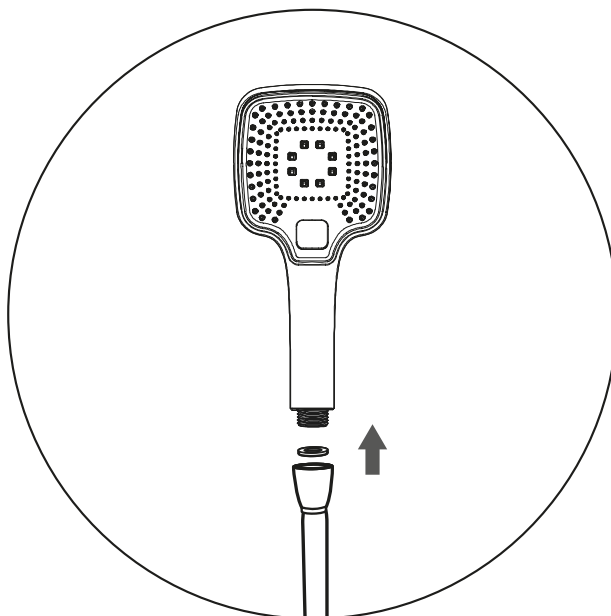

A

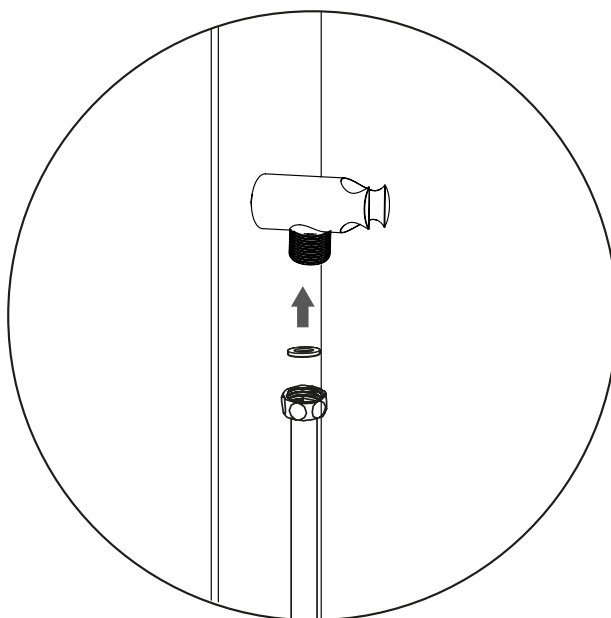

B

Dimension

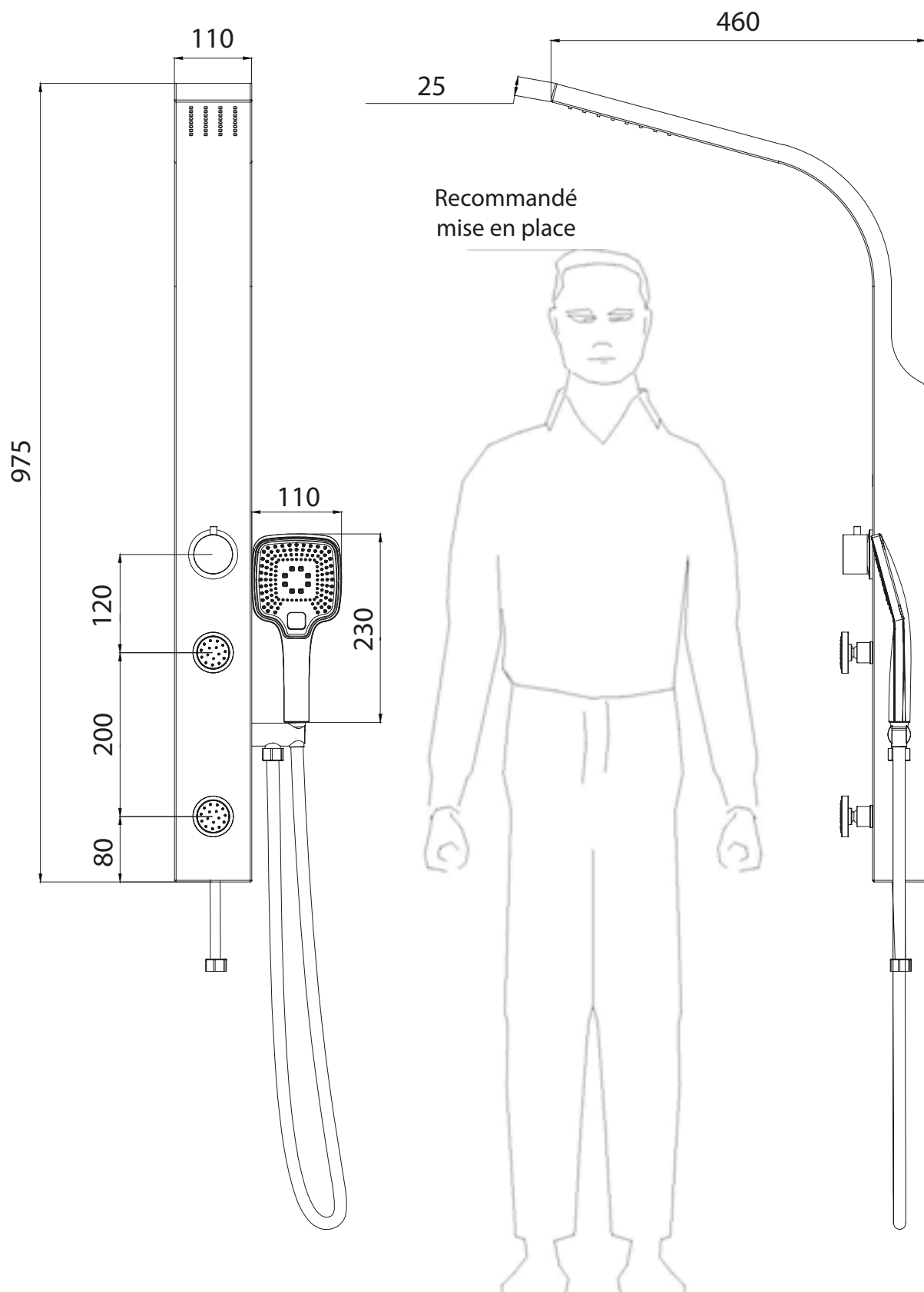

Préparation au bon positionnement du Panneau de douche

1. Référez-vous à la taille corporelle pour déterminer la hauteur de pose du panneau de douche en convertissant votre taille corporelle en mm. Utilisez les schémas A et B pour déterminer le positionnement exact des trous percés destinés à réceptionner le dispositif d'accrochage et les étriers d'appui.

Dimension

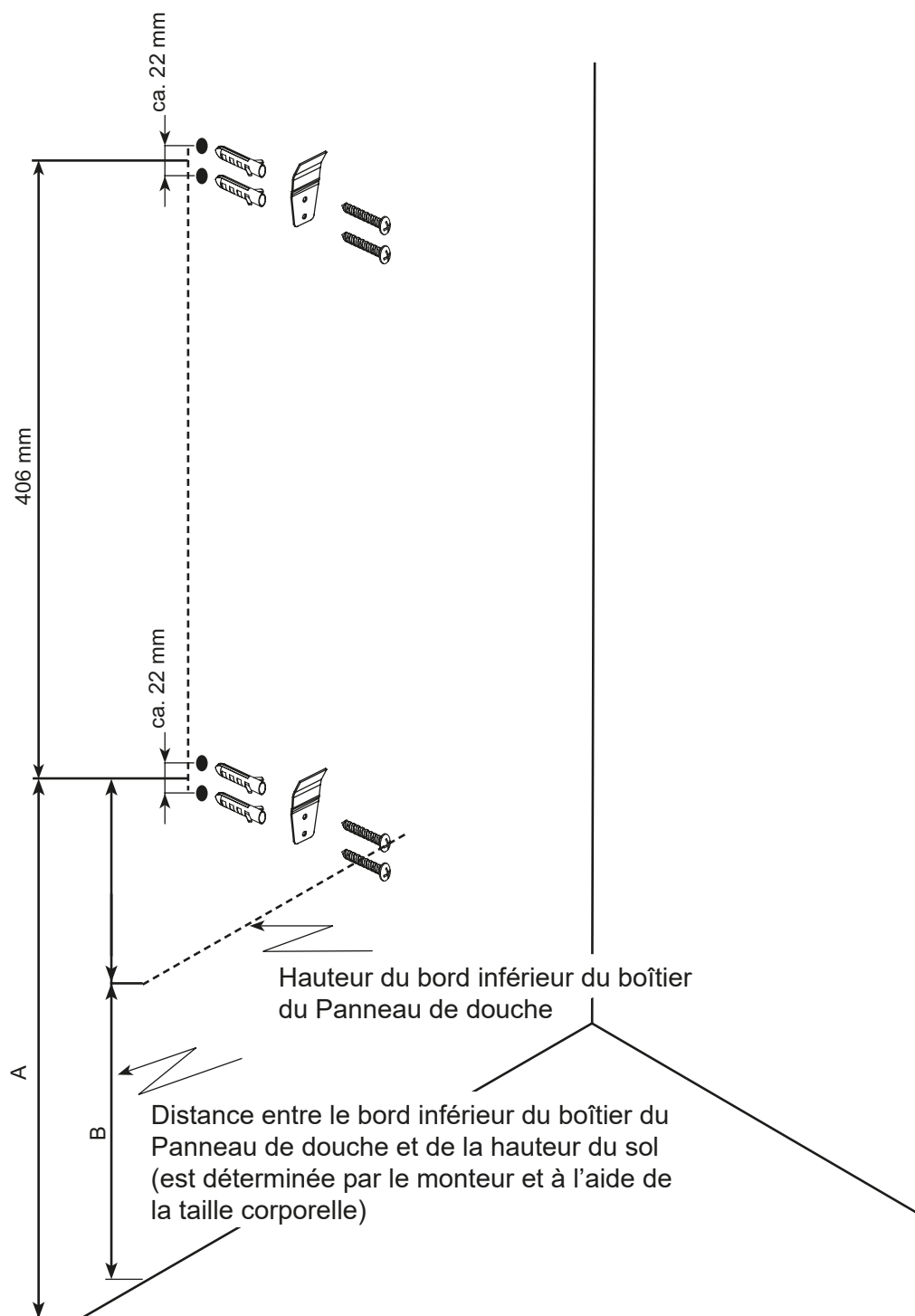

2. Hauteur optimale pour la sortie d'eau chaude et froide et la distance entre les deux robinets d'eau.

3. Reliez les deux flexibles d'admission derrière le Panneau de douche au robinet d'eau chaude et de froide avec une clé à vis. Le flexible gauche est destiné au côté chaud, le droit au côté froid.

Traitement des déchets

Si cet article devient inutilisable, chaque utilisateur est légalement obligé de traiter les vieux appareils ménagers séparément des déchets domestiques, par exemple en les déposant dans un lieu de collecte de sa commune / de son quartier.

Notre service

Vous pourrez bénéficier immédiatement de conseils techniques en contactant notre équipe de services:

- **Allemagne:** téléphone 01806-63 06 30, depuis un poste fixe 20 c/appel, depuis un mobile
- **Autriche:** Universal: téléphone +43 / 662-4485 59, depuis un poste fixe en fonction de l'opérateur, conseil spécialisé bricolage – Otto: +43 / 316-606 159 depuis un poste fixe en fonction de l'opérateur, conseil spécialisé bricolage – Quelle: +43 / 662-9005 59 depuis un poste fixe en fonction de l'opérateur, conseil spécialisé
- **Suisse,** Quelle: **DE:** +41 / 848 85 85 00, **FR:** +41 / 848 85 85 01, I: +41 / 848 858 530
Ackermann: **DE:** +41 / 848 85 85 11, **FR:** +41 / 848 85 85 21, I: +41 / 848 858 530
- **Pays-Bas:** centre d'appel 0900-1901 (15 c/mn)

Pour nous permettre de vous aider aussi rapidement que possible, merci de préciser:

Le nom de l'article : Panneau de douche „Laos“ 64732726–33003338
et le numéro d'article sous lequel vous avez commandé cet article (voir facture).

Importé par Franz Joseph Schütte GmbH, Hullerweg 1, 49134 Wallenhorst (Germany)

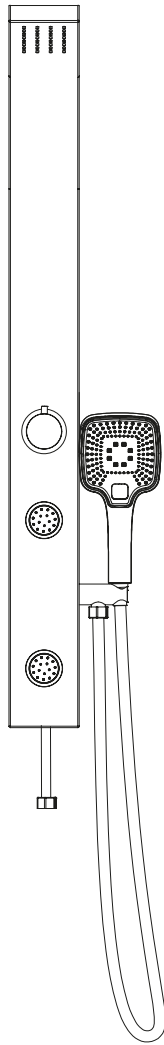

Pannello doccia „Laos“

64732726–33003338

Dimensione: 975 x 460 mm



Aufbauanleitung
Duschpaneel



Istruzioni d'installazione
Pannello doccia



Installations Instructions
Shower panel



Montagehandleiding
Douchepaneel



Instructions d'installation
Panneau de Douche

D: Nachdruck, auch auszugsweise, nicht gestattet! GB: Reproduction, even in extracts, is not permitted! F: Toute reproduction de ce mode d'emploi même par extraits est interdite ! IT: È vietata la riproduzione, anche parziale. NL: Nadruk, ook slechts gedeeltelijk, niet toegestaan!

Anleitung, Nr.: 20236473272633003338

IMPORTANTE, CONSERVARE IL PRESENTE DOCUMENTO PER UN FUTURO RIFERIMENTO! LEGGERE CON ATTENZIONE!

Uso conforme

- Il presente articolo è pannello doccia.
- L'articolo è destinato esclusivamente all'uso privato.



Avvisi di sicurezza

- ATTENZIONE, DANNI CAUSATI DALL'ACQUA!

- Prima di installare il prodotto, si raccomanda di chiudere il sistema di adduzione dell'acqua.
- Controllare in quest'occasione la corretta sede delle guarnizioni.
- Queste pannello doccia non sono adatte per l'utilizzo in serbatoi di accumulo elettrici e a bassa pressione.
- Pannello doccia è concepita per l'impiego in abitazioni private! Essa si adatta esclusivamente per l'utilizzo in locali con temperatura superiore agli 0 °C. In caso di imminente gelo, interrompere l'alimentazione dell'acqua e svuotare il pannello doccia.
- Prestare particolare attenzione nella regolazione dell'acqua calda: pericolo di ustioni!
- Assicurarsi che nessun agente caustico o corrosivo, come detersivi o detergenti per la casa, finiscano nei tubi di collegamento. Ciò potrà causare danni da acqua.
- Pericolo di soffocamento / lesioni! L'imballaggio non è un giocattolo per bambini. Potrebbero soffocarsi con la pellicola o ferirsi con l'involucro.
- Fare attenzione che i bambini non mettano in bocca piccole parti quali bulloni, tappi ecc. L'ingerimento potrebbe comportare il soffocamento.
- Pericolo di danneggiamento! Prima del montaggio, leggere attentamente le istruzioni di montaggio e accertarsi dell'assenza di danni da trasporto. Installare l'articolo con la massima cura.
- Il montaggio dell'articolo è consentito solo alle persone esperte. Si consiglia di effettuare il montaggio con l'aiuto di una seconda persona.
- Pericolo di lesioni! Durante il montaggio, fare attenzione ai bordi taglienti di alcune parti.
- Montare l'articolo esclusivamente a ridosso di una parete adatta e massiccia.
- **Attenzione: Il fissaggio dell'articolo alla parete va effettuato da una persona esperta, dato che il montaggio richiede l'utilizzo di tasselli adatti alla parete.**
- Accertarsi dell'assenza di cavi e tubi nei punti di perforazione.
- Controllare la parete con un cercametalli prima di effettuare i fori.
- Per ordinare le parti di ricambio (ved. lista dei ricambi) si prega di rivolgersi al servizio clienti.
- **Le parti per il fissaggio non sono contenute nella fornitura e si possono acquistare nei negozi specializzati.**

Avvisi per la pulizia

Per la pulizia si consiglia l'utilizzo di una spugna o di un panno morbido. Sono sufficienti i detersivi ecologici e/o delicati. Si sconsiglia l'utilizzo di detersivi aggressivi o contenenti solventi. Non utilizzare oggetti taglienti, lana d'acciaio, agenti chimici o abrasivi contenenti sabbia. Potrebbero danneggiare la superficie e comportare di conseguenza la decadenza della garanzia. Le incrostazioni leggere di calcare si possono rimuovere facilmente con dell'aceto.

Attrezzi necessari

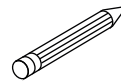
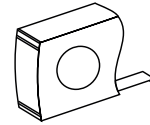
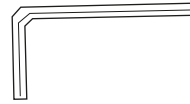
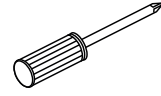
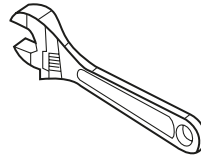
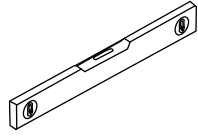
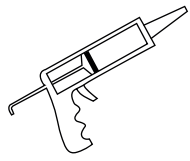

L'elevato peso del prodotto potrebbe rendere necessario l'aiuto di una seconda persona per il montaggio

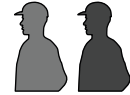

Contenuto della confezione

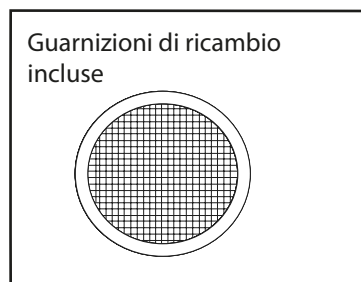
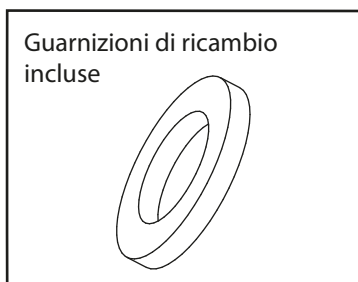
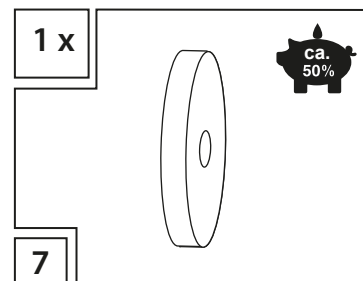
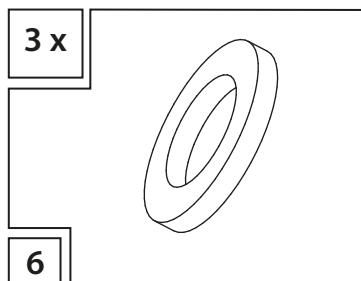
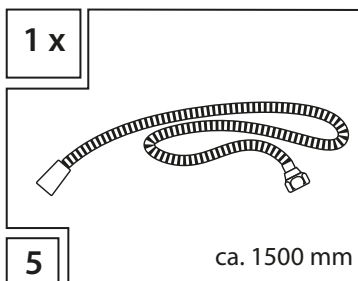
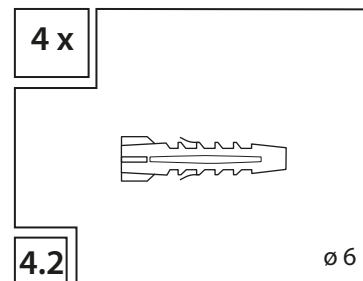
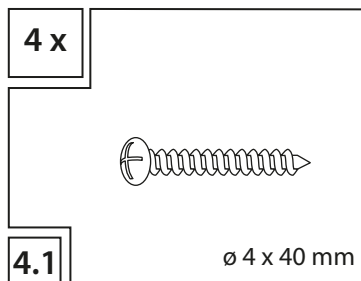
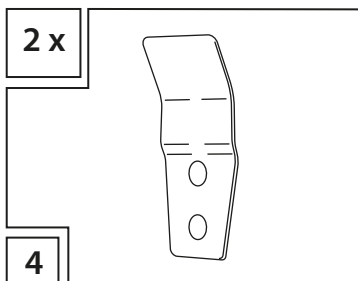
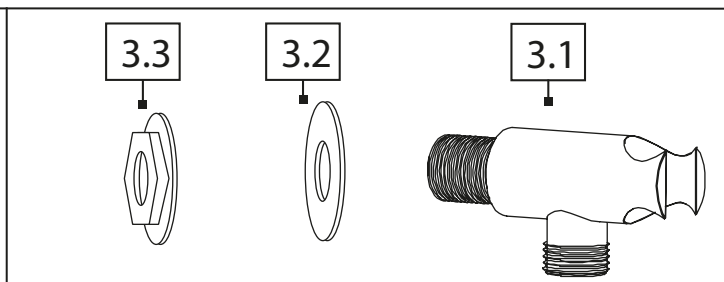
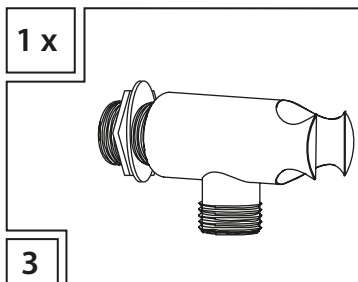
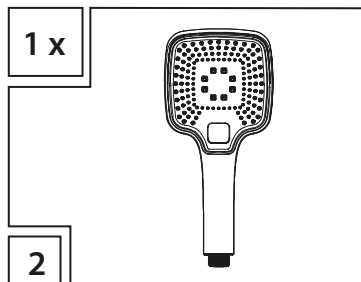
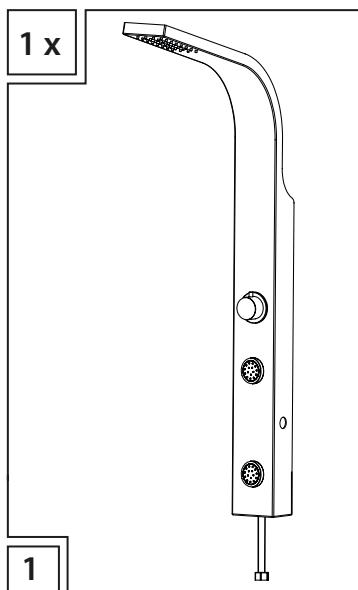

Schema di montaggio

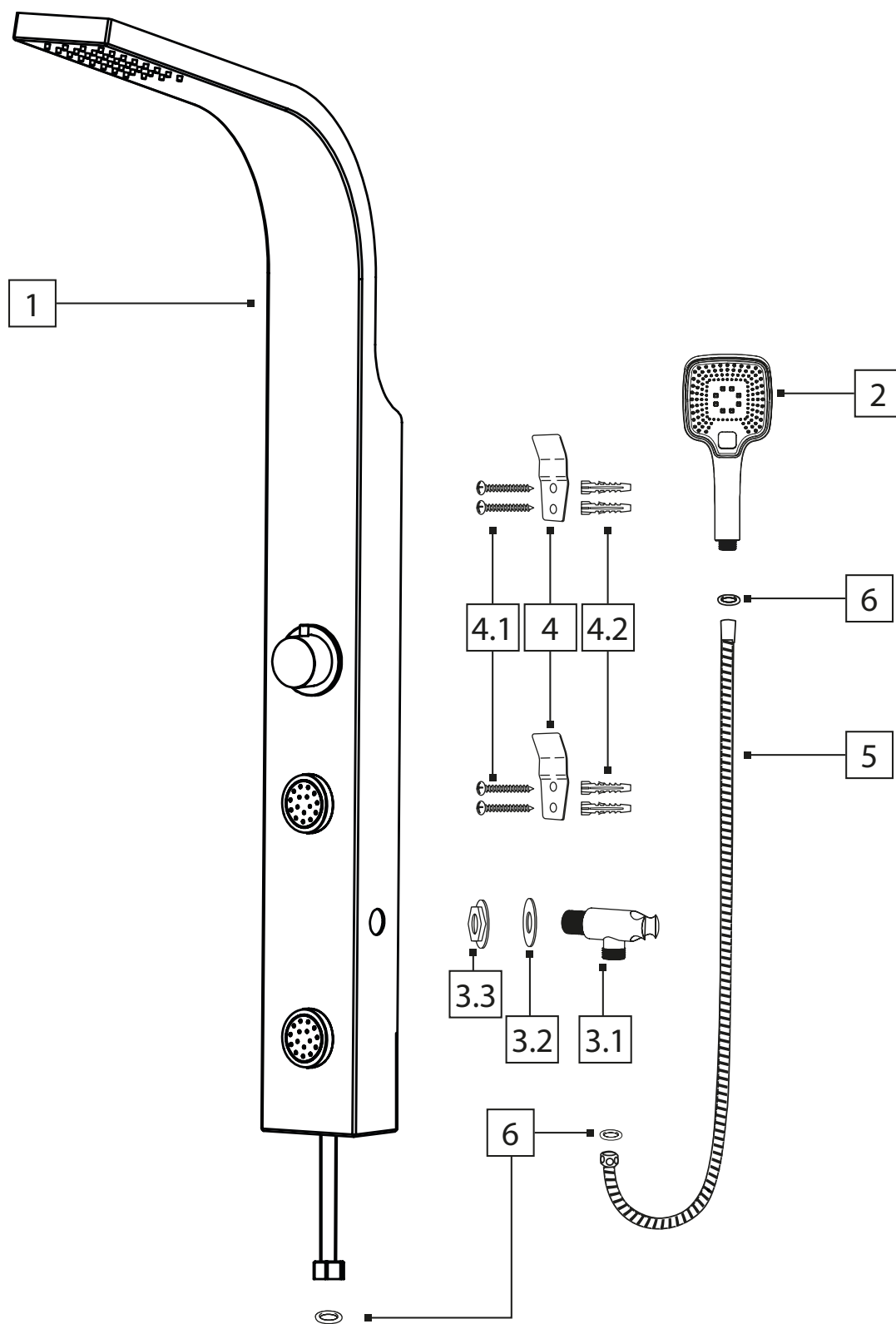

Fasi di montaggio

Di seguito sono rappresentate tutte le fasi di montaggio delle componenti principali pannello doccia

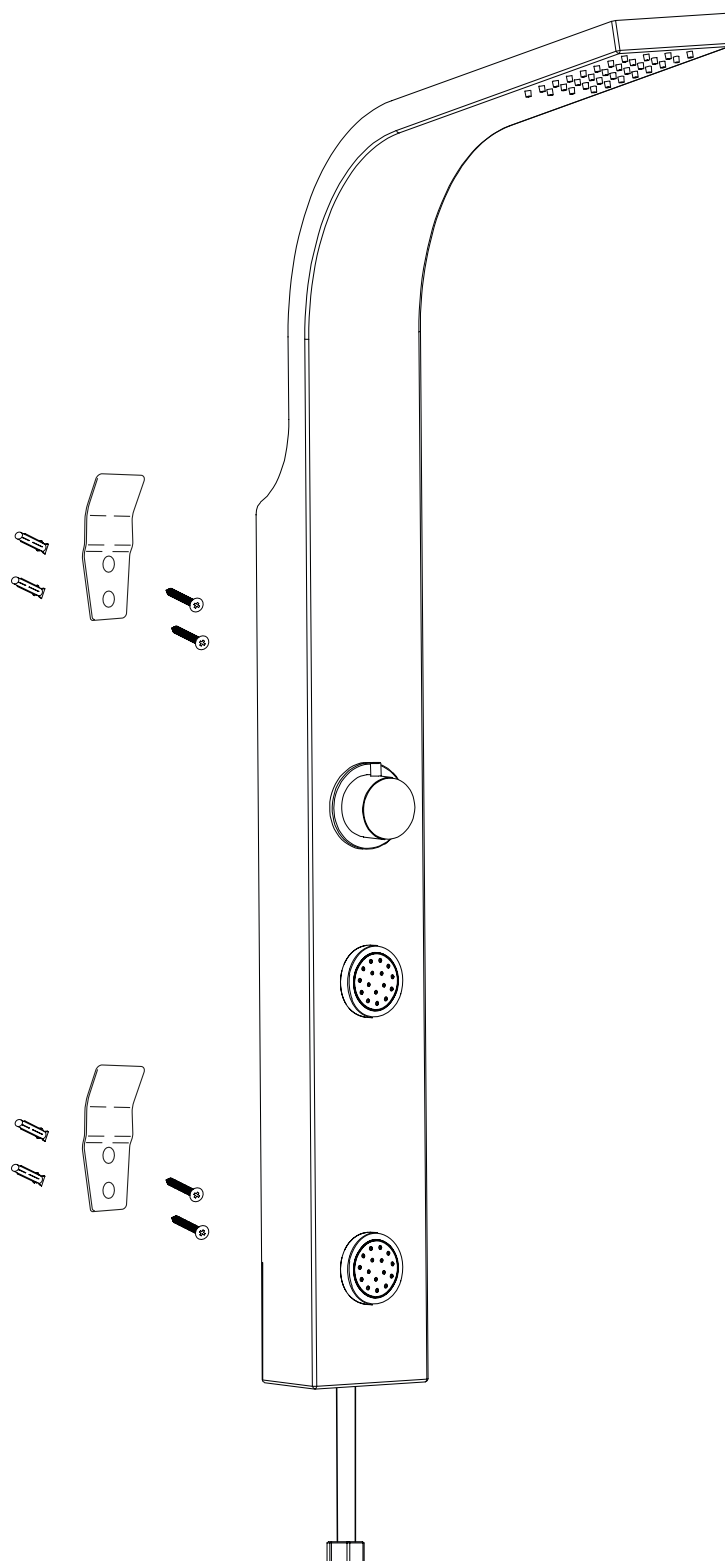

Allineamento del pannello doccia in base all'altezza personale

In base all'altezza personale, si raccomanda l'installazione del soffione a una distanza di ca. 260 mm sopra la propria testa. In caso si prevedesse l'utilizzo pannello doccia da più persone, il riferimento per il posizionamento del soffione è l'altezza dell'utente più alto: il soffione va posizionato a tale altezza più 260mm.

Fasi di montaggio

Di seguito sono rappresentate tutte le fasi di montaggio delle componenti principali pannello doccia

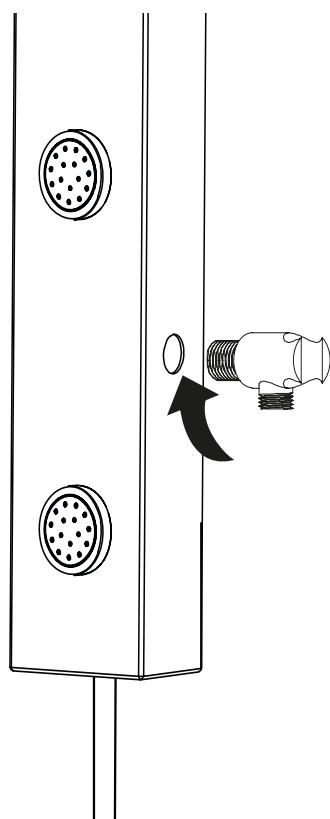
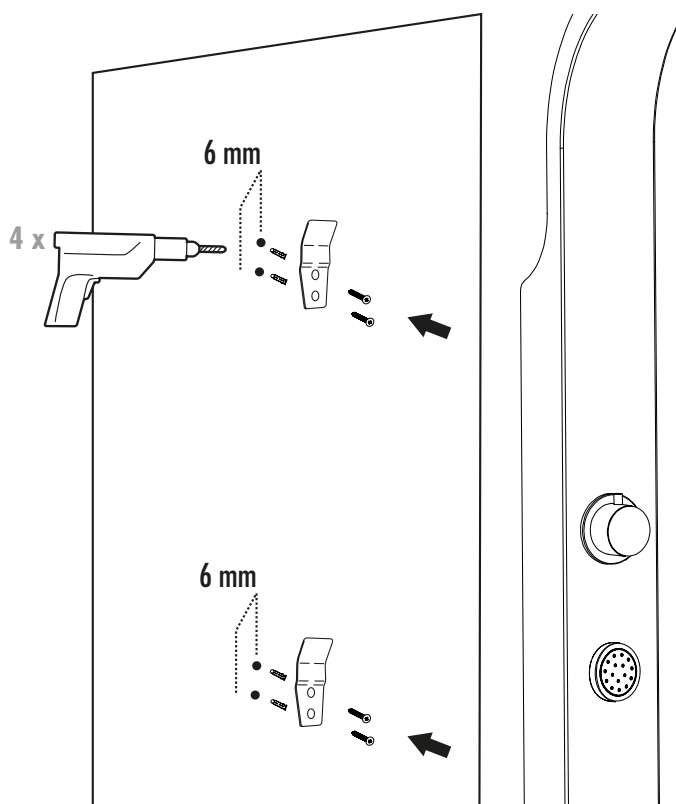

Fasi di montaggio

Di seguito sono rappresentate tutte le fasi di montaggio delle componenti principali pannello doccia

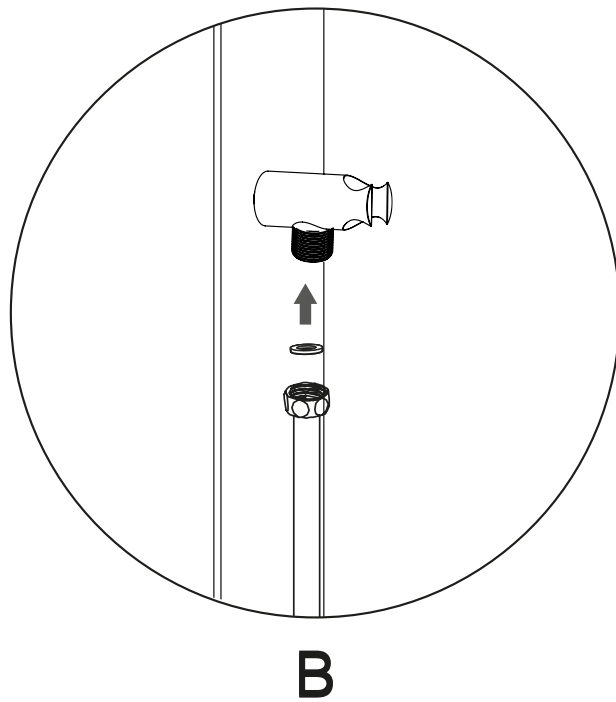
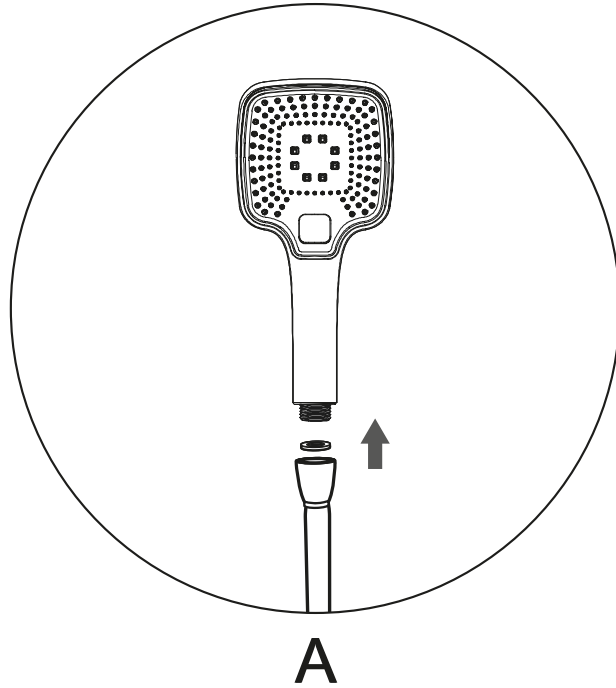

Misure

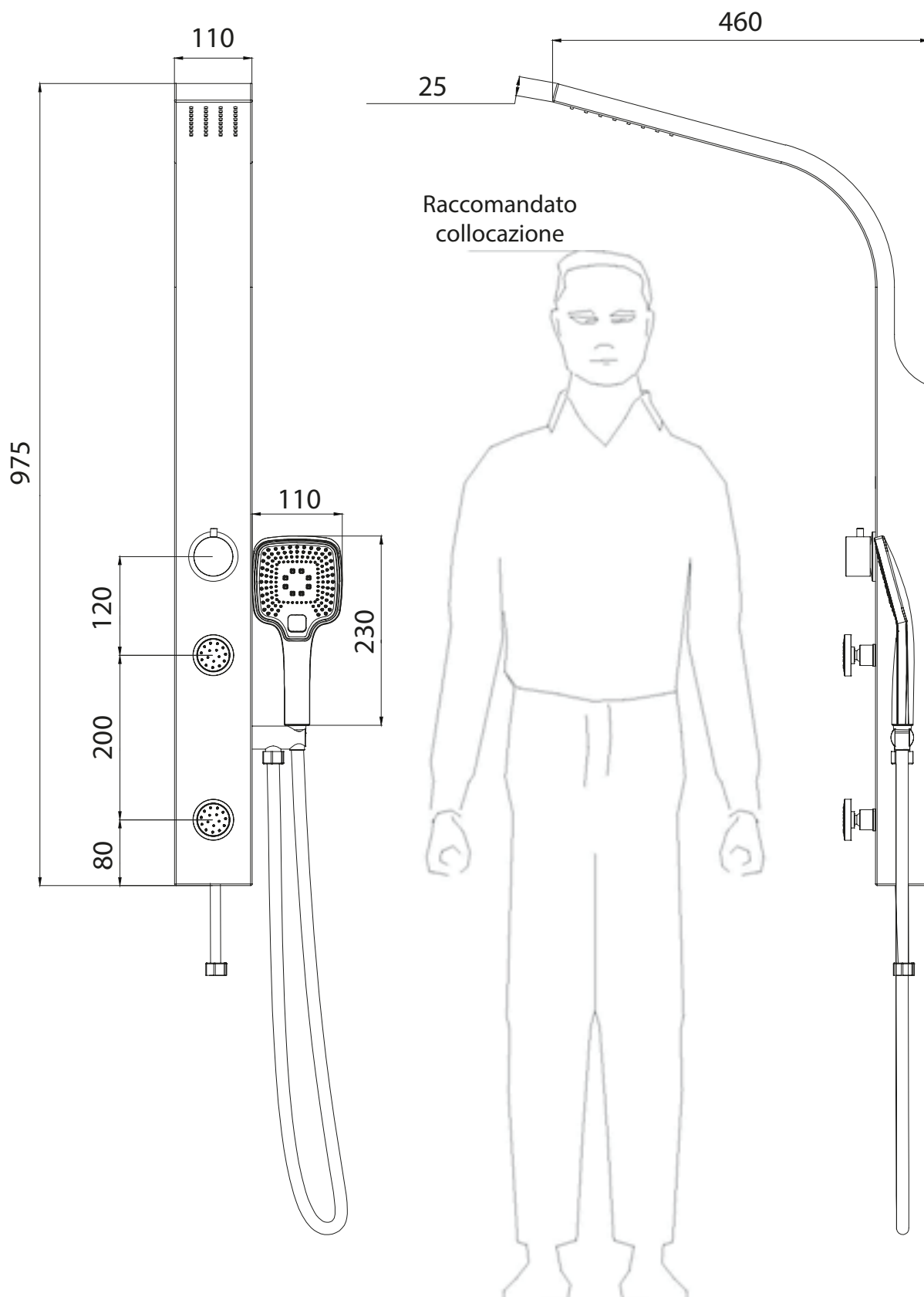

Preparazione per il corretto posizionamento pannello doccia

1. Per calcolare l'altezza di montaggio del pannello doccia, basatevi sulla vostra altezza personale in mm. Usare le figure A e B per individuare l'esatta posizione dei fori per il fissaggio del dispositivo di sospensione e delle staffe di sostegno.

Misure

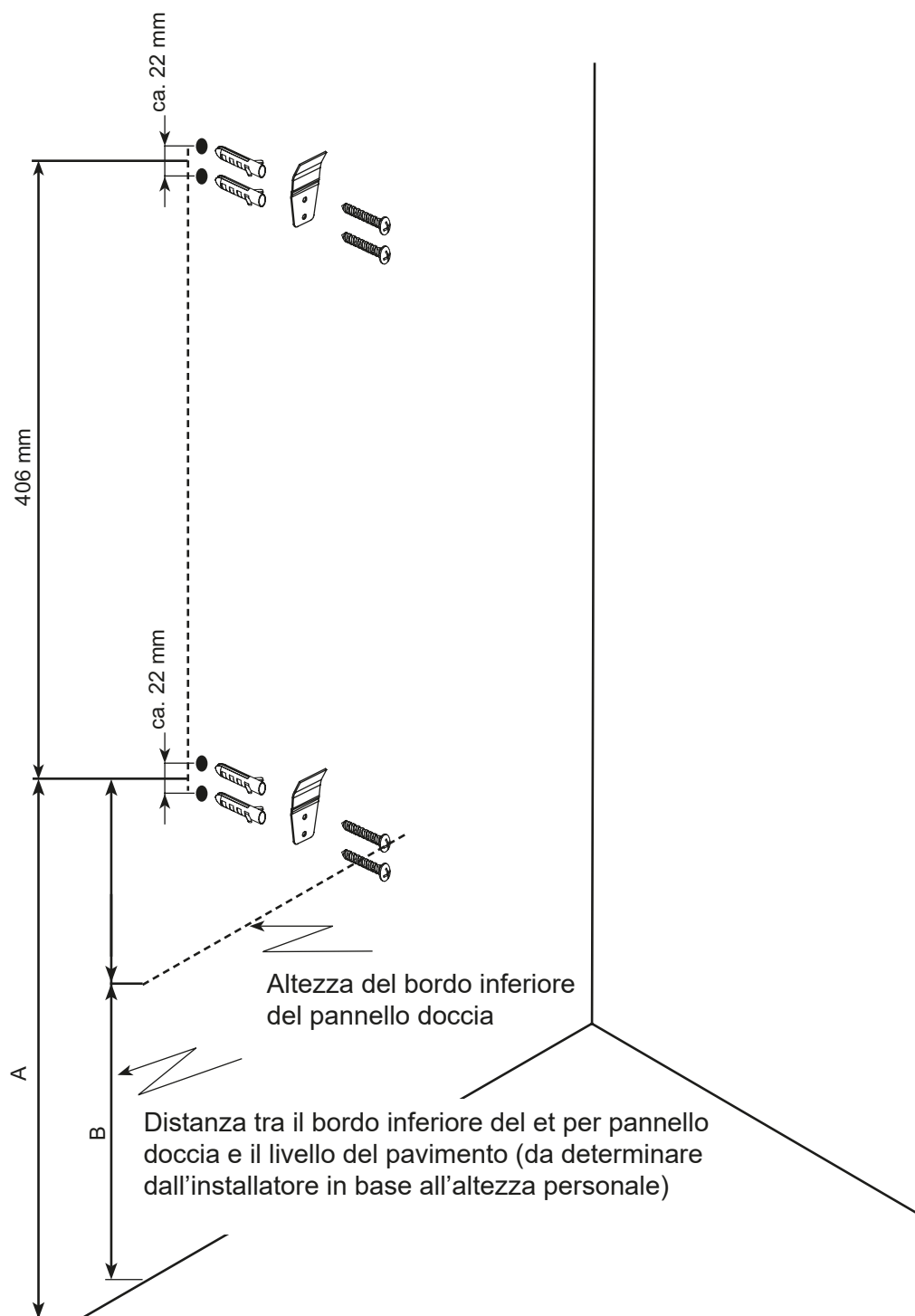

2. Altezza ottimale per lo sfogo dell'acqua calda/fredda e la distanza tra i due rubinetti.

3. Collegare i due tubi d'ingresso dell'acqua, dietro il pannello doccia, con i rubinetti dell'acqua calda/fredda con l'aiuto di una chiave. Il tubo sinistro è per l'acqua calda, il tubo destro è per l'acqua fredda.

Smaltimento

Qualora l'articolo non dovesse più servire, ogni consumatore è obbligato per legge allo smaltimento separato delle vecchie apparecchiature consegnandole ad esempio all'ecocentro del proprio comune / quartiere.

Il nostro servizio

Il nostro team di servizio vi offre una rapida consulenza specialistica:

- **Germania:** telefono 01806-63 06 30, rete fissa 20ct/chiamata, telefonia mobile max. 60 ct/chiamata
- **Austria, Universal:** telefono +43 / 662-4485 59, rete fissa a secondo del gestore, consulenza specialistica per il fai da te – Otto: +43 / 316-606 159 rete fissa a secondo del gestore, consulenza specialistica per il fai da te – Quelle: +43 / 662-9005 59 rete fissa a secondo del gestore, consulenza specialistica per il fai da te
- **Svizzera, Quelle:** **DE:** +41 / 848 85 85 00, **FR:** +41 / 848 85 85 01, **I:** +41 / 848 858 530
- **Ackermann:** **DE:** +41 / 848 85 85 11, **FR:** +41 / 848 85 85 21, **I:** +41 / 848 858 530
- **Paesi bassi:** call center 0900-1901 (15ct/min.)

Per poter garantire un celere aiuto, si prega di indicare:

Il nome dell'articolo: Pannello doccia „Laos“ 64732726–33003338
e il **codice articolo** con il quale avete ordinato l'articolo (ved. scontrino).

Imported by Franz Joseph Schütte GmbH, Hullerweg 1, 49134 Wallenhorst (Germany)

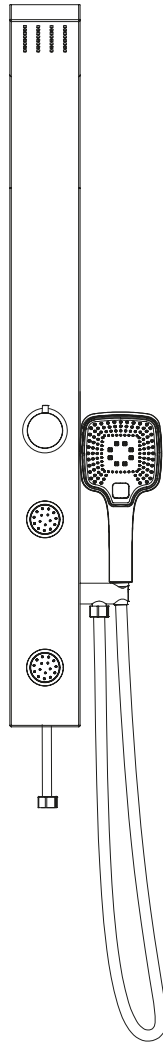

Douchepaneel „Laos“

64732726–33003338

Grootte: 975 x 460 mm



Aufbauanleitung
Duschpaneel



Istruzioni d'installazione
Pannello doccia



Installations Instructions
Shower panel



Montagehandleiding
Douchepaneel



Instructions d'installation
Panneau de douche

D: Nachdruck, auch auszugsweise, nicht gestattet! GB: Reproduction, even in extracts, is not permitted! F: Toute reproduction de ce mode d'emploi même par extraits est interdite ! IT: È vietata la riproduzione, anche parziale. NL: Nadruk, ook slechts gedeeltelijk, niet toegestaan!

Anleitung, Nr.: 20236473272633003338

**BELANGRIJK, BEWAAR DIT DOCUMENT VOOR EVENTUELE
TOEKOMSTIGE RAADPLEGING! ZORVULDIG LEZEN!**

Beoogd gebruik

- Dit artikel is een Douchepaneel om te douchen.
- Dit artikel is uitsluitend bedoeld voor privégebruik.



Veiligheidsinstructies

- **WEES VOORZICHTIG: WATERSCHADE!**
Gelieve vóór de montage de algemene watertoevoer uit te schakelen.
- Let erop dat alle afdichtingen juist op hun plaats zitten.
- Deze Douchepaneel zijn niet geschikt voor het gebruik aan lagedruk- en elektrische kleine boilers.
- Wij adviseren de inbouw van een filter in de installatie of minstens het gebruik van haakse afsluiters met filter om het binnentreden van vreemde voorwerpen, die het patroon schade kunnen berokkenen, te vermijden.
- Douchepaneel voor het gebruik in particuliere huishoudens! Uitsluitend geschikt voor het gebruik in kamers met een temperatuur van meer dan 0 °C, bij vorstgevaar watertoevoer onderbreken en armatuur ledigen.
- **WEES VOORZICHTIG** bij warmwaterinstelling: Gevaar voor brandwonden!
- Zorg ervoor, dat er geen bijtende of corrosieve middelen, zoals poetsmiddelen of huishoudelijke schoonmaakmiddelen in/aan de aansluitlangen terechtkomen; dit kan tot waterschade leiden.
- Verstikkingsgevaar en risico op letsel! Laat uw kinderen nooit met de verpakking spelen. Ze zouden in het plastic kunnen stikken en zich aan de verpakking kunnen verwonden.
- Let er op dat kinderen geen kleine onderdelen zoals moeren, doppen of iets dergelijks in hun mond nemen. Bij inslikken bestaat er een risico op verstikking.
- Risico op schade! Lees de handleiding voor het monteren nauwkeurig door en controleer het product op eventuele transportschade. Wees zorgvuldig bij het monteren van het artikel.
- Het artikel mag uitsluitend door vakmensen worden gemonteerd. Het verdient aanbeveling om de montage door twee personen te laten uitvoeren.
- Risico op letsel! Let er bij de montage op dat sommige onderdelen scherpe randen hebben.
- Monteer het artikel uitsluitend aan een daarvoor geschikte, massieve muur.
- Let op: De wandmontage van dit artikel moet door een deskundige persoon worden uitgevoerd, daar voor de wandmontage speciale pluggen nodig zijn.
- Ga na of er op de plekken waar geboord wordt geen kabels of leidingen lopen.
- Controleer die plekken voor het boren met een metaaldetector.
- Neem voor het bestellen van onderdelen (zie onderdelenlijst) contact op met de klantenservice.
- **Onderdelen ter bevestiging zijn niet inbegrepen in de levering en moeten in de vakwinkel worden gekocht**

Onderhoudsadvies

Gebruik voor het reinigen en het onderhoud een spons of een zachte doek. Milieuvriendelijke en milde huishoudelijke schoonmaakmiddelen zijn al voldoende. Gebruik in geen geval agressieve of oplosmiddelhoudende schoonmaakmiddelen. Gebruik in geen geval scherpe voorwerpen, staalwol, chemicaliën of zandhoudende schuurmiddelen voor de reiniging. Dit kan leiden tot schade aan het oppervlak en het vervallen van de garantie. Lichte kalkaanslag kunt u zonder problemen met een kleine hoeveelheid huishoudazijn verwijderen.

Benodigd gereedschap

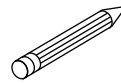
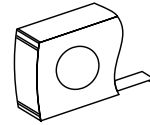
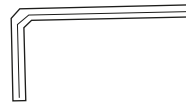
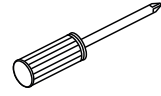
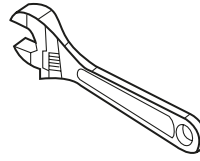
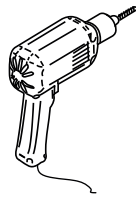
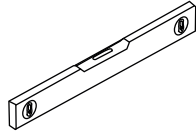
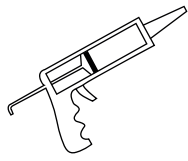

Vanwege het gewicht van dit product zijn er mogelijk twee personen nodig voor de montage.



Inhoud

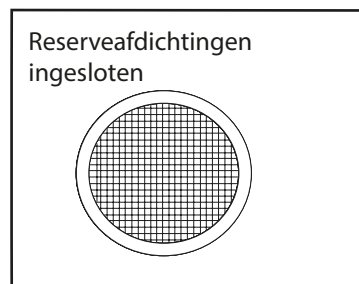
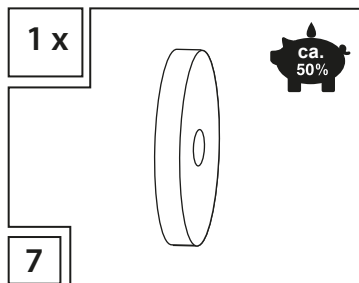
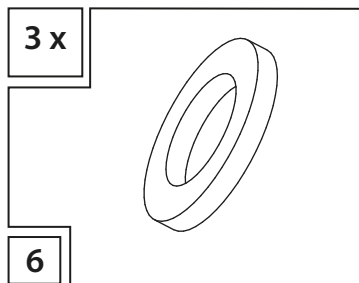
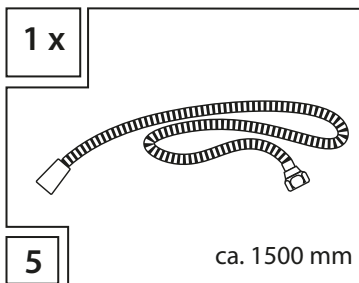
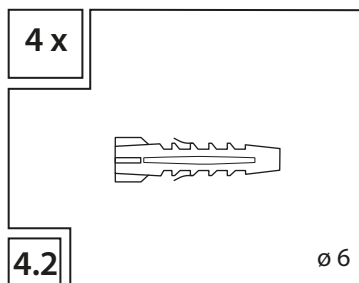
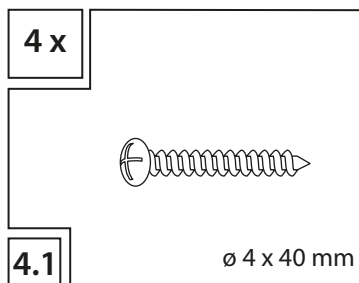
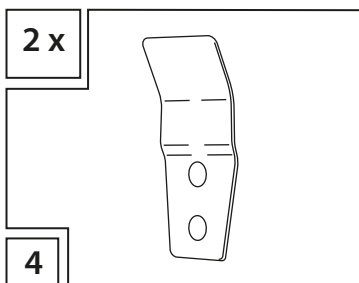
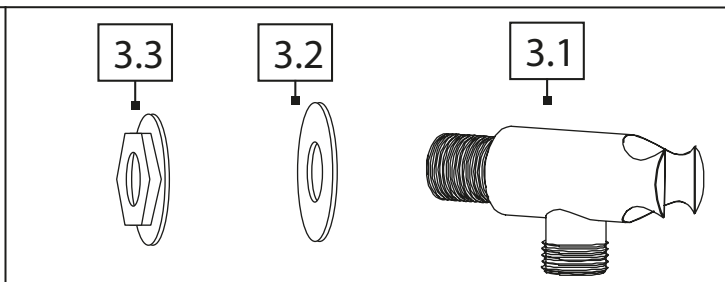
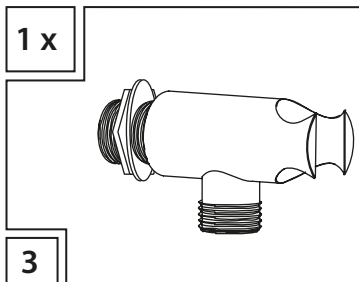
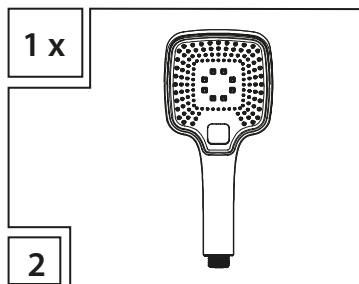
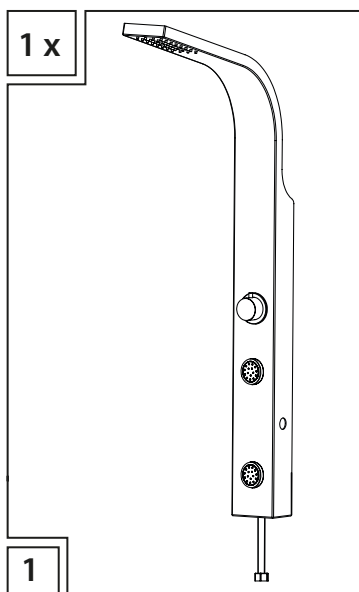

Montagetekening

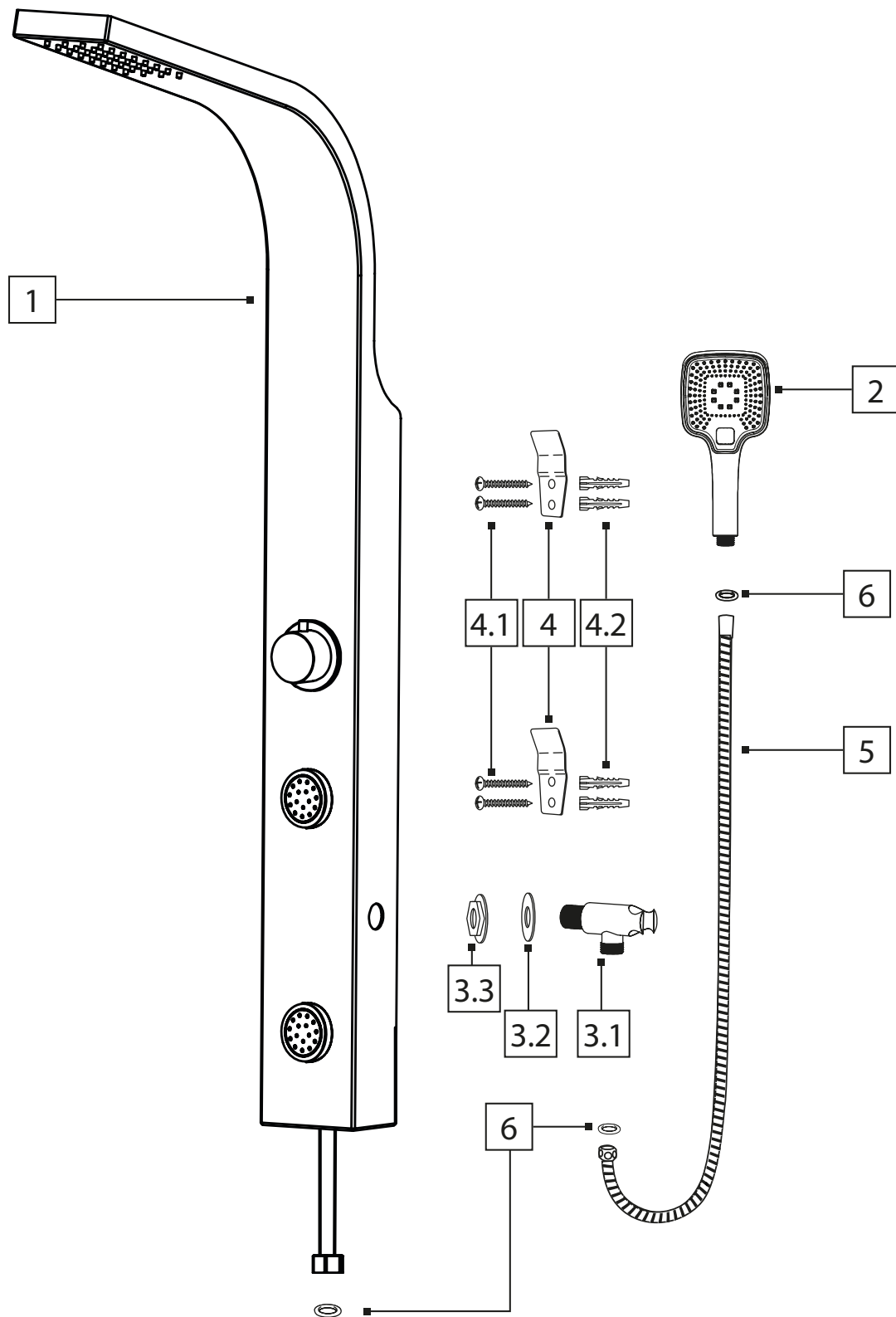

Montagestappen

Hieronder zien we een handleiding stap per stap voor de opbouw van de hoofddelen van het Douchepaneel.

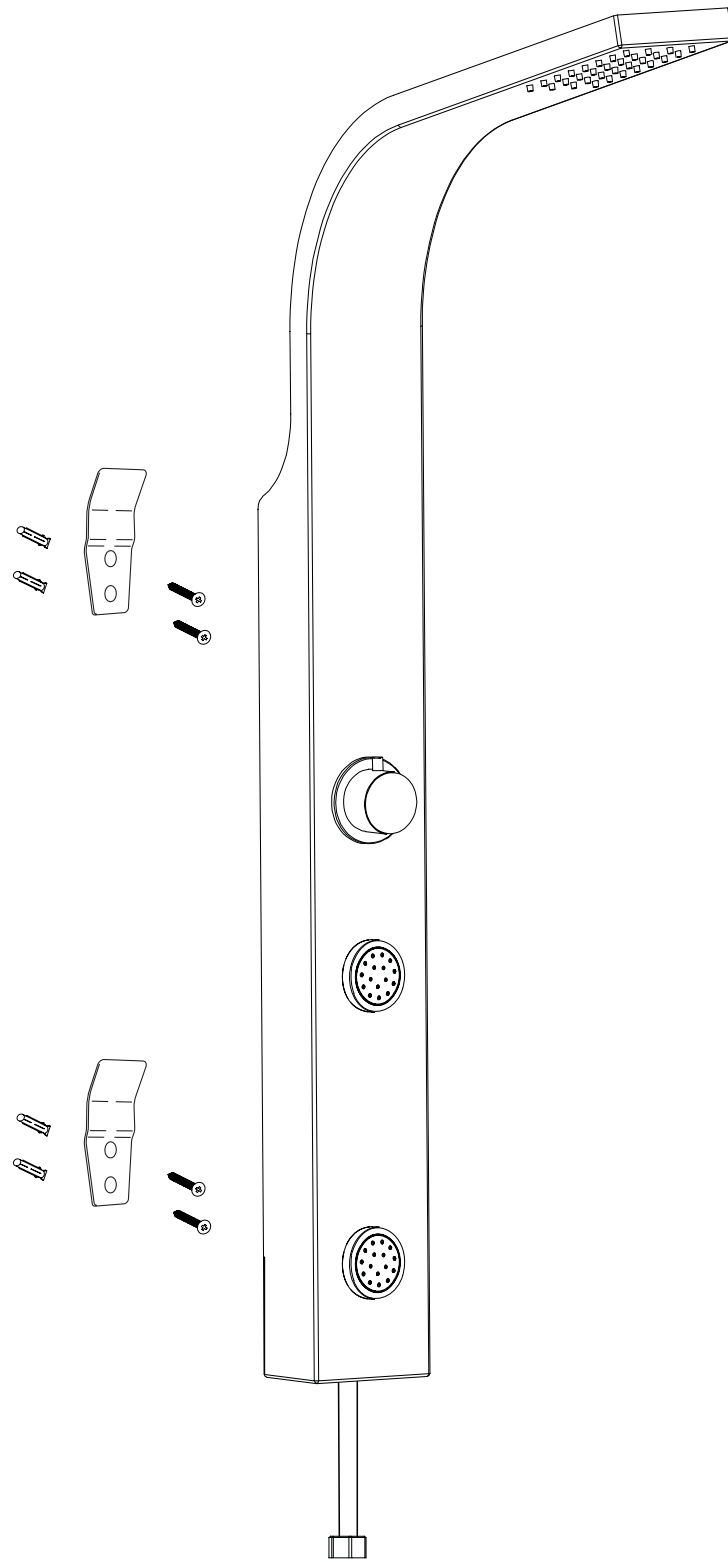

Afstelling Douchepaneel op lichaamsgrootte

Afhankelijk van uw lichaamsgrootte is het aanbevolen om de douchekep op een afstand van ca. 260 mm boven het hoofd te plaatsen. Als meerdere personen in uw huishouden het douchepaneel willen gebruiken, meet u de lichaamsgrootte van de grootste persoon en plaatst u de douchekep.

Montagestappen

Hieronder zien we een handleiding stap per stap voor de opbouw van de hoofd delen van het Douchepaneel.

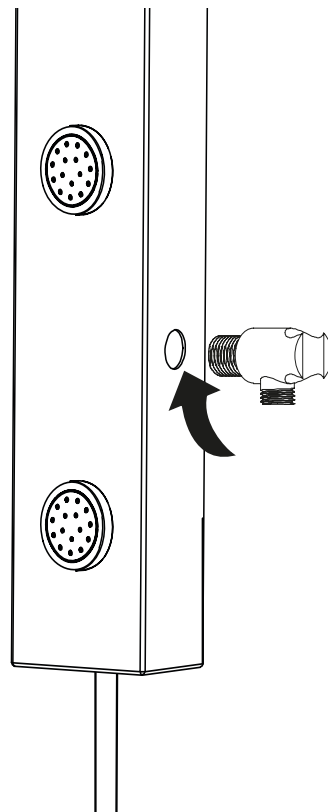
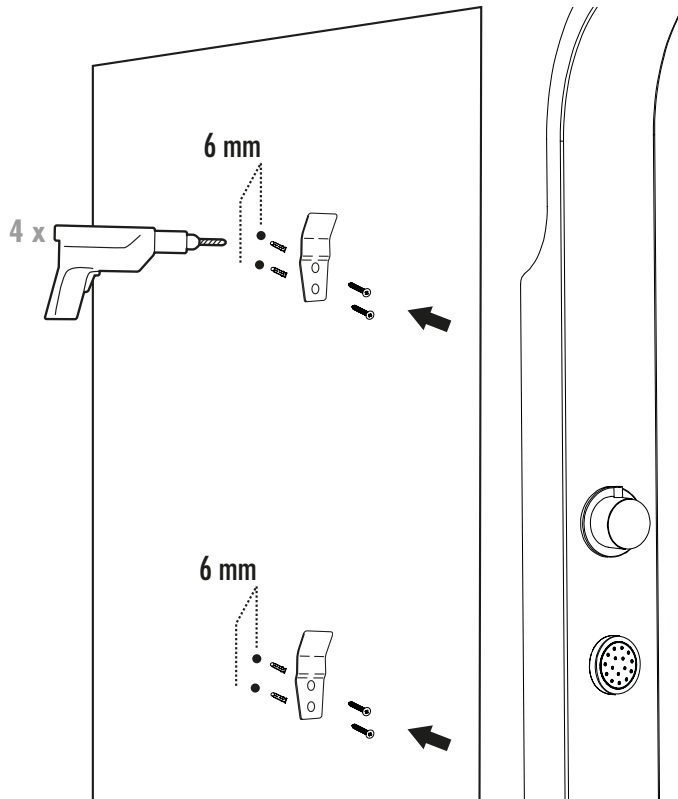

Montagestappen

Hieronder zien we een handleiding stap per stap voor de opbouw van de hoofddelen van het Douchepaneel.

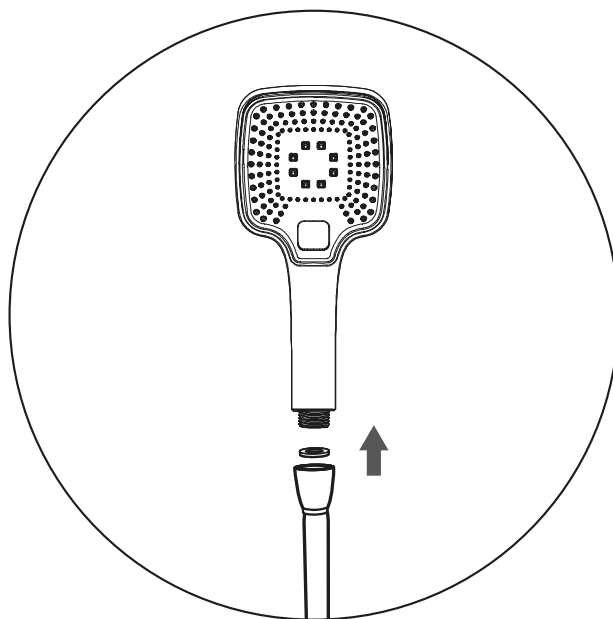

A

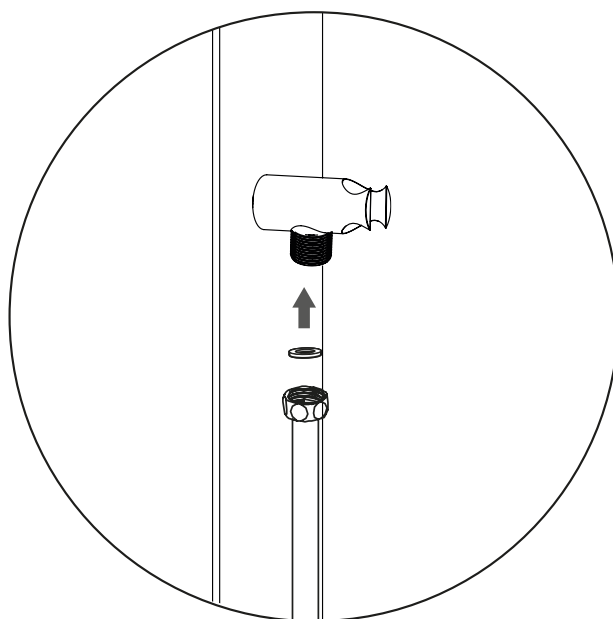

B

Afmeting

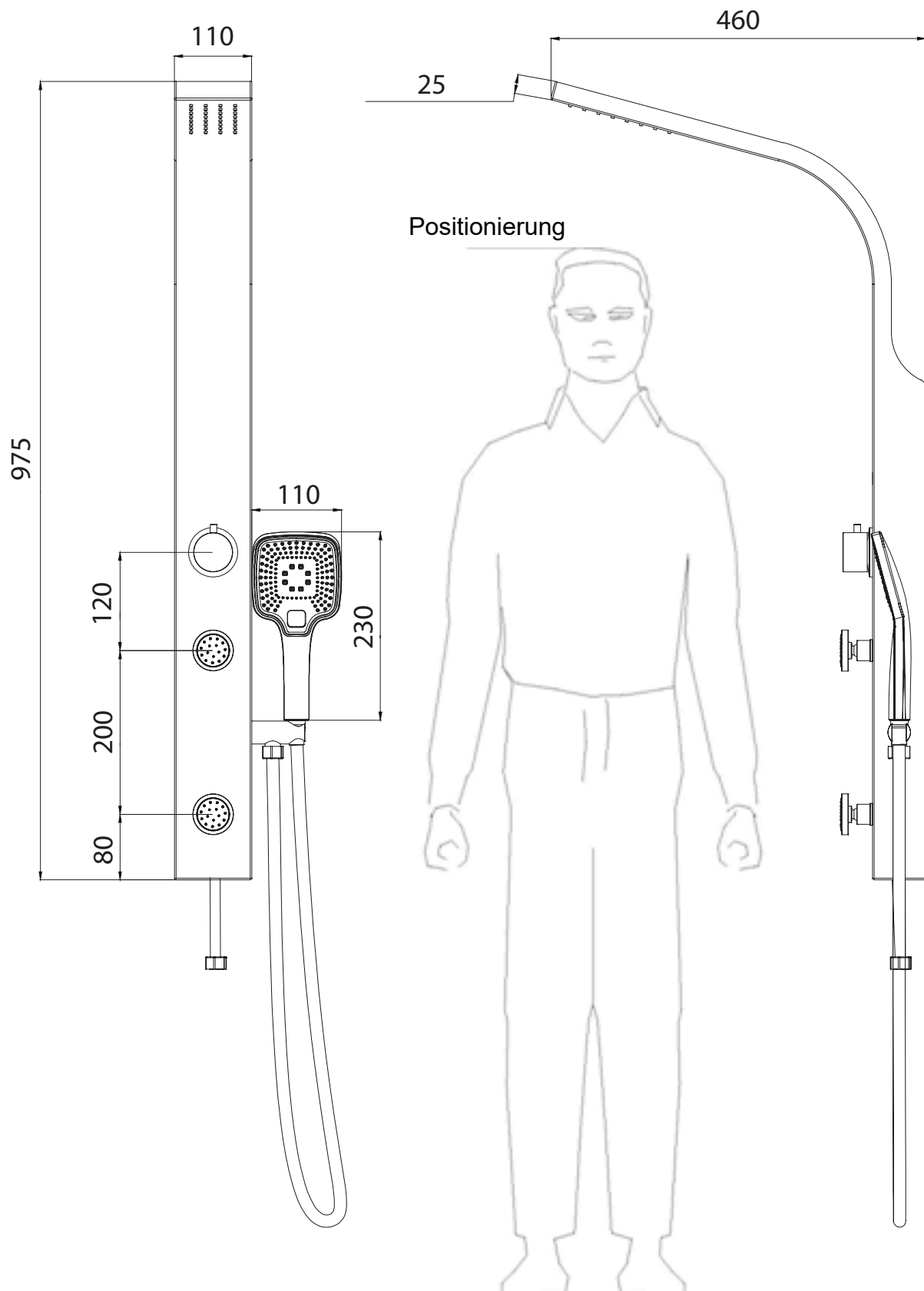

Vorbereitung voor het correct positioneren van het Douchepaneel

1. Gebruik uw lichaamsgrootte voor het bepalen van de aanbrenghoogte van het douchepaneel door uw lichaamsgrootte in mm om te rekenen. Gebruik de tekeningen A en B om de correcte positionering van de boorgaten te bepalen voor het aanbrengen van de ophangvoorziening en de steunbeugel.

Afmeting

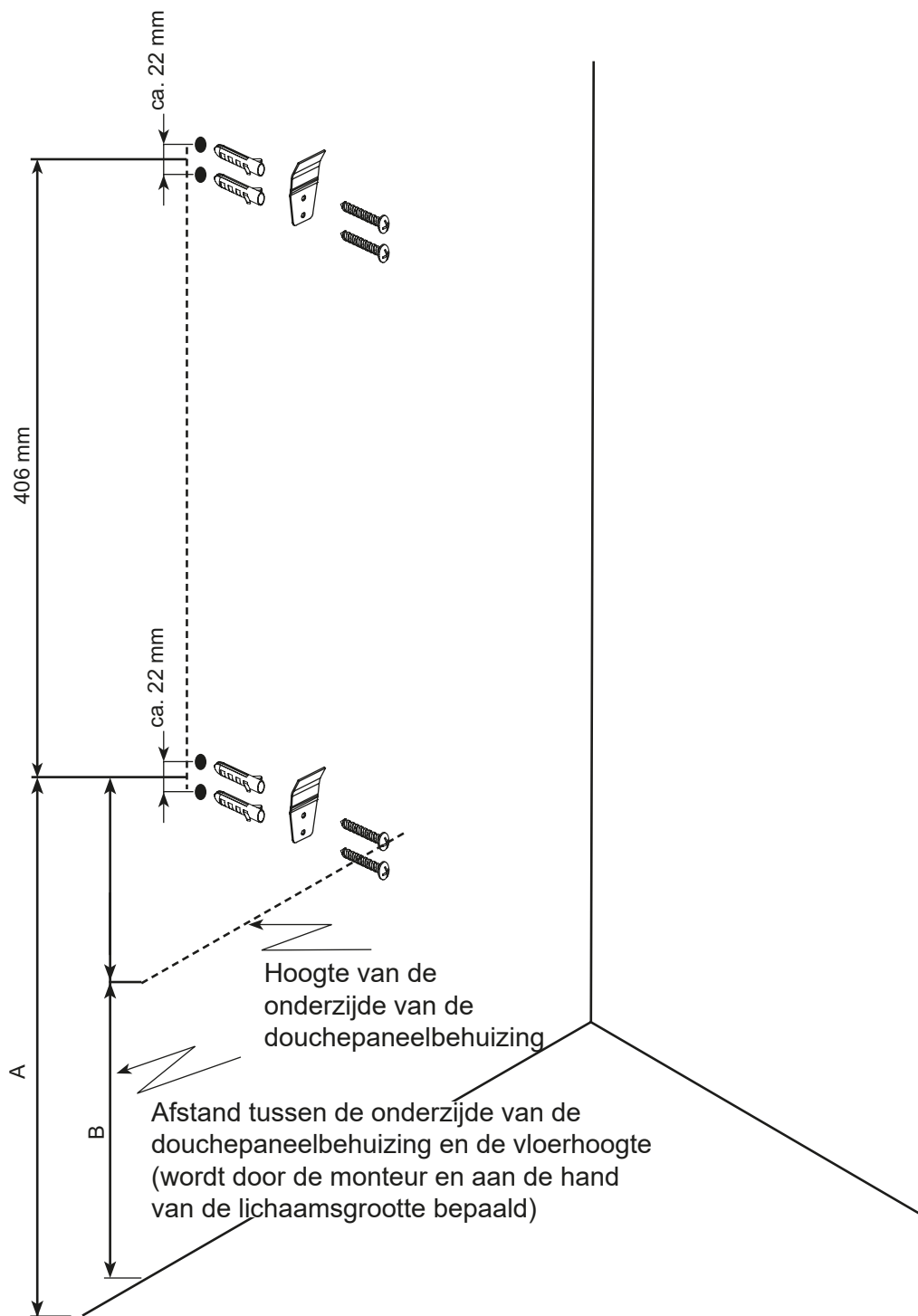

2. Optimale hoogte voor de warm-/ koudwaterknop en de afstand tussen beide waterkranen.

3. Verbind de twee waterinvoerslangen achter het Douchepaneel met een schroevendraaier met de warm-/ koudwaterkraan. De linkerslang is voor de warme, de rechterslang voor de koude zijde.

Afvalverwijdering

Indien dit product niet meer gebruikt wordt, is elke consument wettelijk verplicht om dergelijke huisraad apart van het huisvuil te verwijderen en bijv. bij de gemeente/milieustraat in te leveren.

Onze service

Ons serviceteam staat u onmiddellijk vakkundig te woord:

- **Duitsland:** Telefoon 01806-63 06 30, Vaste lijn20ct/gesprek, Mobiel max. 60 ct/gesprek
- **Oostenrijk, Universal:** Telefoon +43 / 662-4485 59, Vaste lijn afhankelijk van aanbieder, Service afd. Doe-het-zelf - Otto: +43 / 316-606 159 - , Vaste lijn afhankelijk van aanbieder, Service afd. Doe-het-zelf - Quelle: +43 / 662-9005 59, Vaste lijn afhankelijk van aanbieder, Service afd. Doe-het-zelf
- **Zwitserland,** Quelle: **DE:** +41 / 848 85 85 00, **FR:** +41 / 848 85 85 01, **I:** +41 / 848 858 530
Ackermann: **DE:** +41 / 848 85 85 11, **FR:** +41 / 848 85 85 21, **I:** +41 / 848 858 530
- **Nederlande,** call center 0900-1901 (15ct/Min.)

Voor een snelle service verzoeken wij u om het volgende te vermelden:

Productomschrijving: Douchepaneel „Laos“ 64732726–33003338
alsmede het **Artikelnummer** waaronder u het artikel heeft besteld (zie factuur).

Imported by Franz Joseph Schütte GmbH, Hullerweg 1, 49134 Wallenhorst (Germany)