

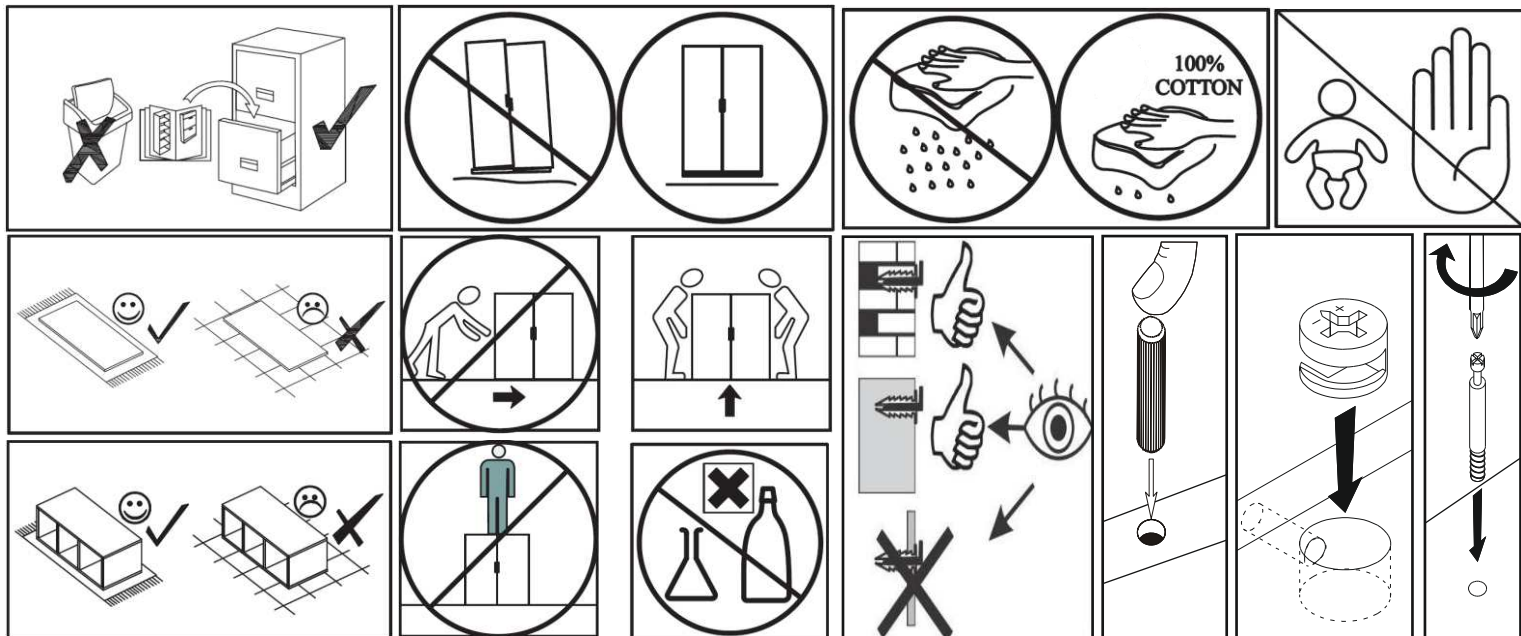

VULCAN ANBAUWAND 89/679/_/3 1/32

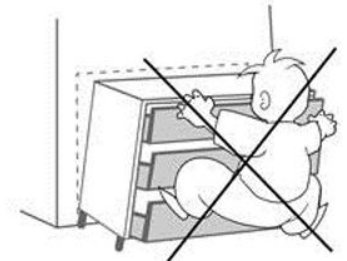

wyprodukowano dla / made for / produziert für
BEGA GRUPPE
producent: **MEBLE OKMED** POLAND

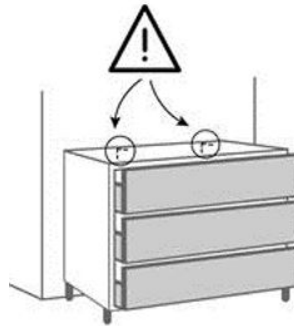
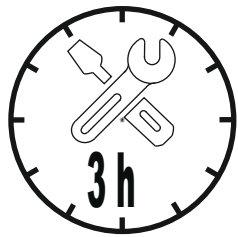
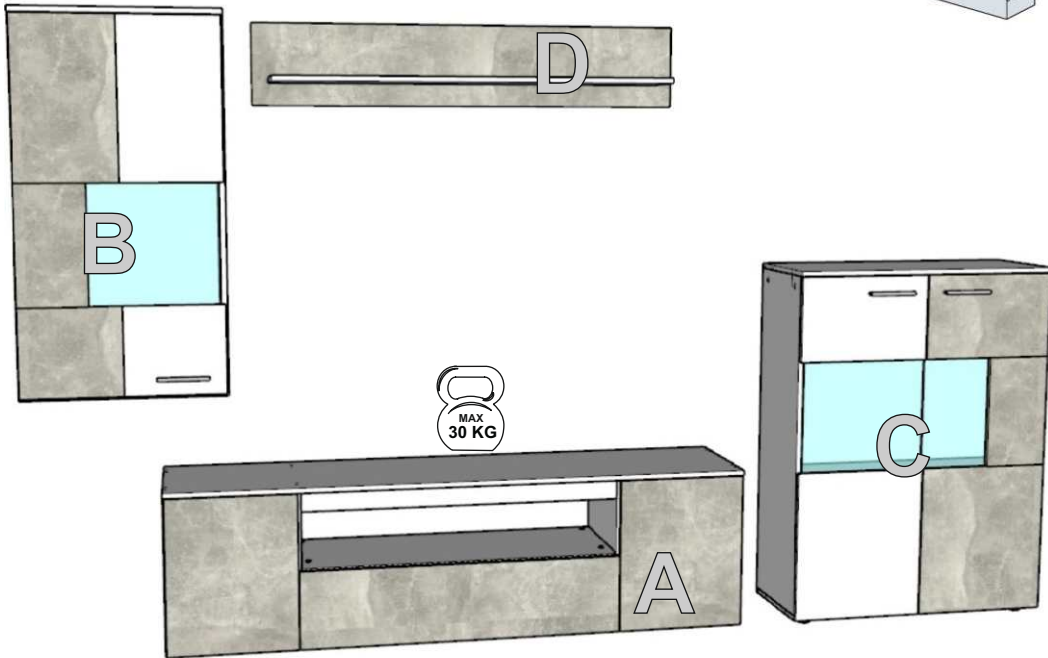
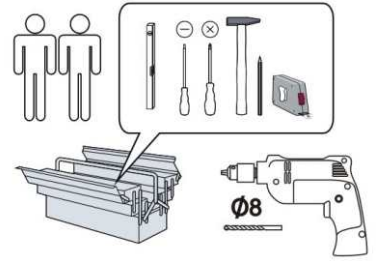

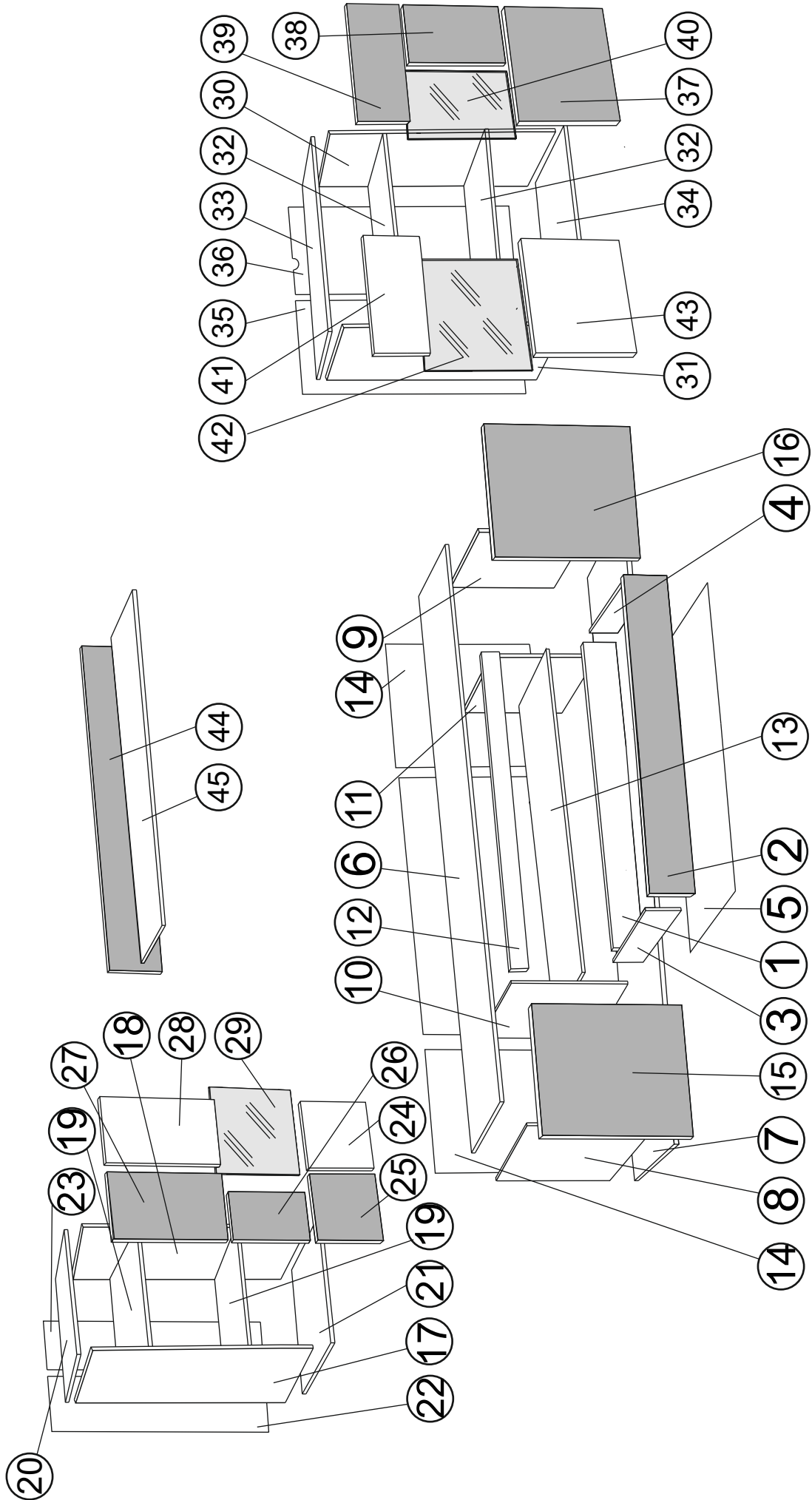

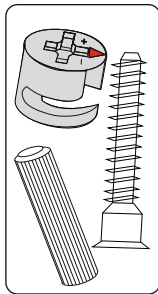
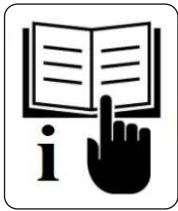



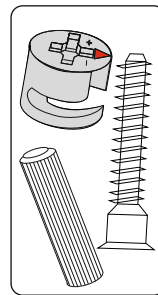







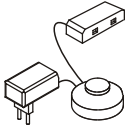
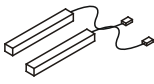
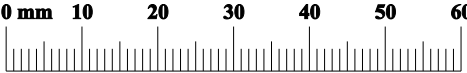















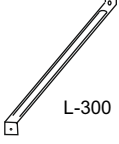
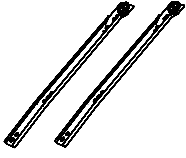

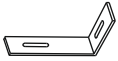



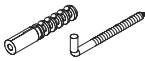

1/4	3	16x300x110	x1
	4	16x300x110	x1
	1	16x923x94	x1
	12	16x981x65	x1
	13	16x315x981	x1
	6	16x400x1800	x1
	2	16x996x237	x1
	15	16x396x472	x1
	16	16x396x472	x1
	14	3x462x400	x2
5	3x937x305	x1	



2/4	10	16x315x462	x1
	11	16x315x462	x1
	7	16x381x1800	x1
	8	16x381x462	x1
	9	16x381x462	x1
	45	16x1250x210	x1
	44	16x1350x250	x1
	35	3x1094x417	x1
36	3x1094x417	x1	

3/4	32	16x315x817	x2
	19	16x315x567	x2
	20	16x352x600	x1
	21	16x333x600	x1
	17	16x333x1078	x1
	18	16x333x1078	x1
	28	16x296x472	x1
	24	16x296x265	x1
	25	16x296x265	x1
	27	16x296x472	x1
	26	16x200x351	x1
	22	3x1094x292	x1
23	3x1094x292	x1	

4/4	31	16x333x1078	x1
	30	16x333x1078	x1
	34	16x333x850	x1
	33	16x352x850	x1
	38	16x200x351	x1
	39	16x265x420	x1
	37	16x472x420	x1
	41	16x265x420	x1
	43	16x472x420	x1
	29	4x411x411	x1
	42	4x404x411	x1
40	4x250x411	x1	

<p>ZKL</p>  <p>x1</p>	<p>ZKL1</p>  <p>x1</p>				
<p>K1</p>  <p>7x50</p> <p>x18</p>	<p>K2</p>  <p>7x70</p> <p>x7</p>	<p>ZK1</p>  <p>ø11</p> <p>x4</p>	<p>KK1</p>  <p>x1</p>	<p>U26</p>  <p>x6</p>	<p>UW</p>  <p>3,5x27</p> <p>x12</p>
<p>ZM1B</p>  <p>x42</p>	<p>ZM1A</p>  <p>x56</p>	<p>TPP2</p>  <p>L-48</p> <p>x7</p>	<p>ZM1</p>  <p>ø16</p> <p>x45</p>	<p>ZM1</p>  <p>ø16</p> <p>x11</p>	<p>KSK1</p>  <p>Glue</p> <p>x1</p>
<p>KD1</p>  <p>8x35</p> <p>x58</p>	<p>KD2</p>  <p>8x60</p> <p>x13</p>	<p>S1</p>  <p>x24</p>	<p>W1</p>  <p>3x16</p> <p>x37</p>	<p>WW1</p>  <p>L-300</p> <p>x1</p>	<p>PME6</p>  <p>x1</p>
<p>W11</p>  <p>3,5x16</p> <p>x11</p>	<p>KS1</p>  <p>x3</p>	<p>SS3</p>  <p>x10</p>	<p>W6</p>  <p>4x20</p> <p>x10</p>	<p>W16</p>  <p>5x11</p> <p>x4</p>	<p>ZRM1</p>  <p>x2</p>
<p>KRW1</p>  <p>x7</p>	<p>KRL1</p>  <p>x2</p>	<p>ZRB</p>  <p>L/R</p> <p>x2</p>	<p>LMM1</p>  <p>x2</p>	<p>W7</p>  <p>4x30</p> <p>x4</p>	<p>OS1</p>  <p>x4</p>
<p>Z1P</p>  <p>x13</p>	<p>Z1P</p>  <p>x13</p>	<p>W4</p>  <p>4x13</p> <p>x26</p>	<p>LI</p>  <p>L-1078</p> <p>x2</p>	<p>W12</p>  <p>4x16</p> <p>x9</p>	<p>TS1</p>  <p>x9</p>

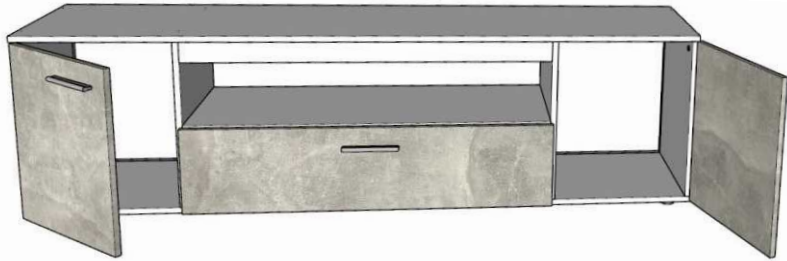
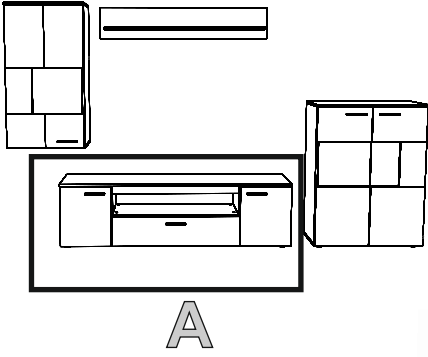

01

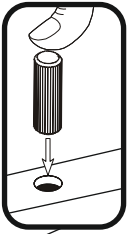
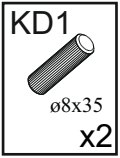

1

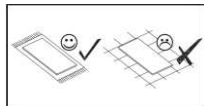
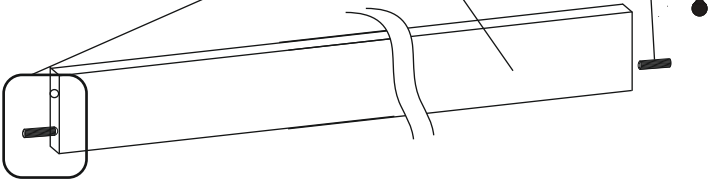

02

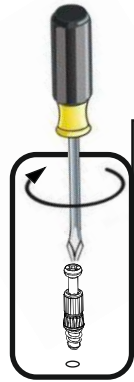

2

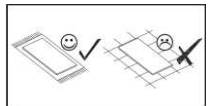
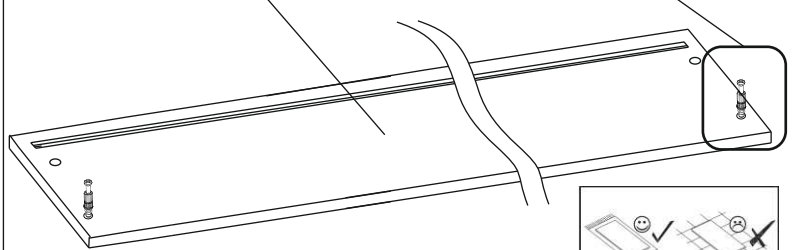

03

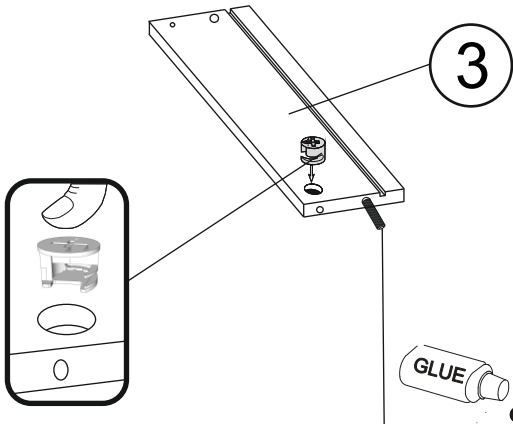
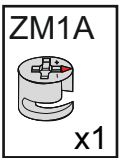
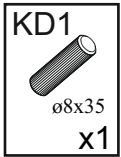

3

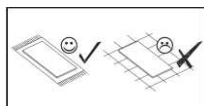

04

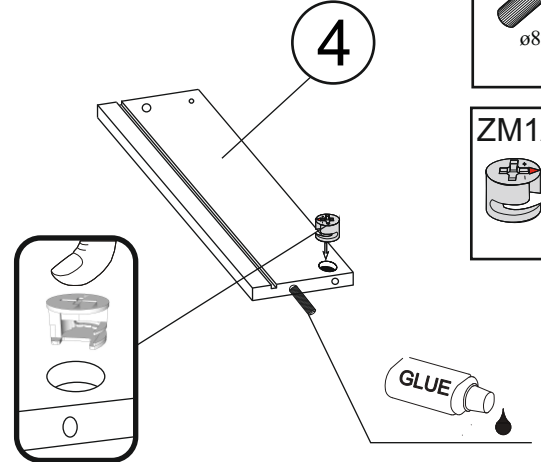
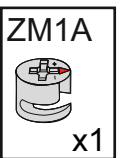
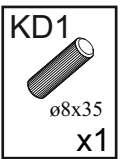

4

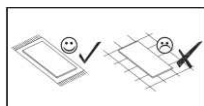

05

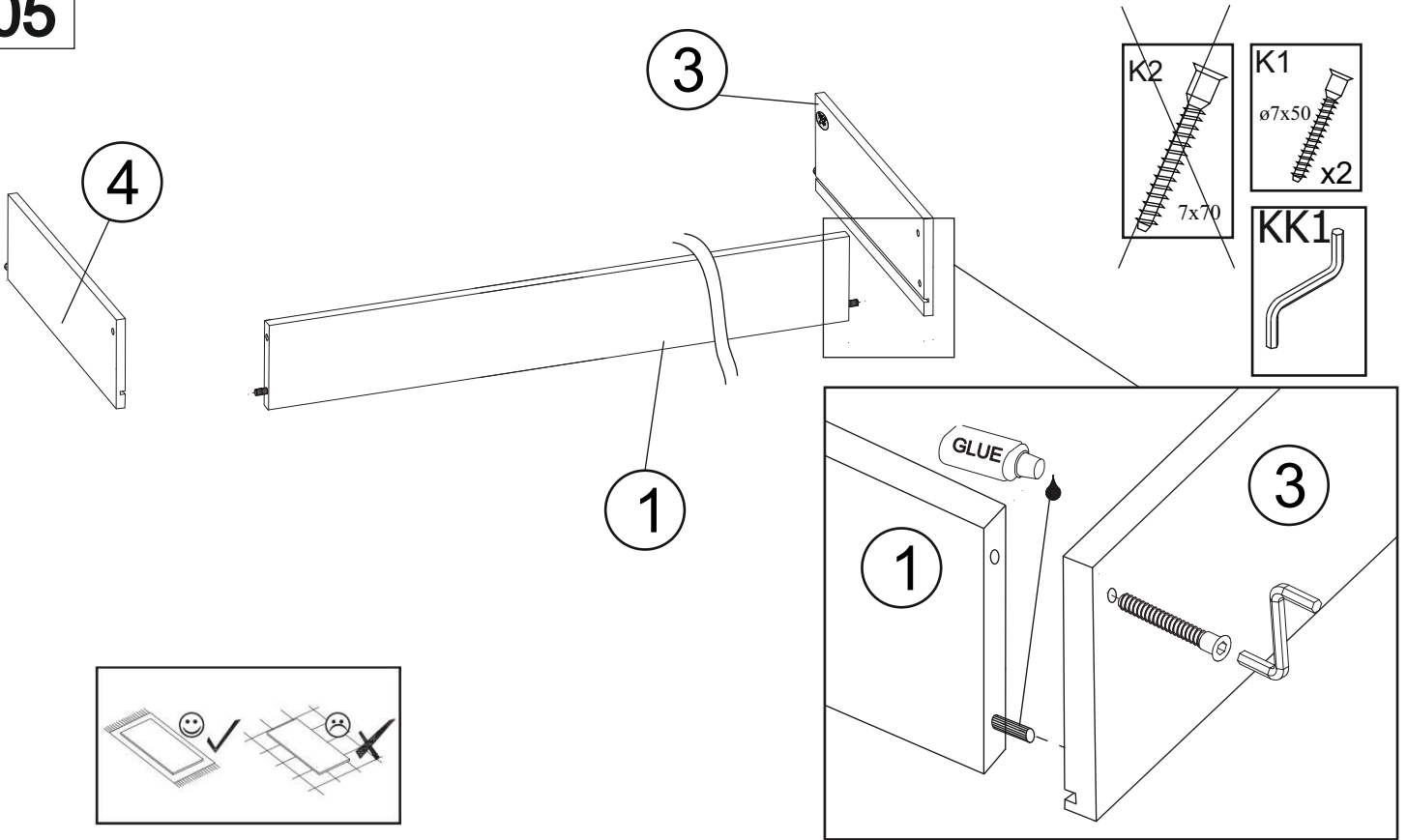

06

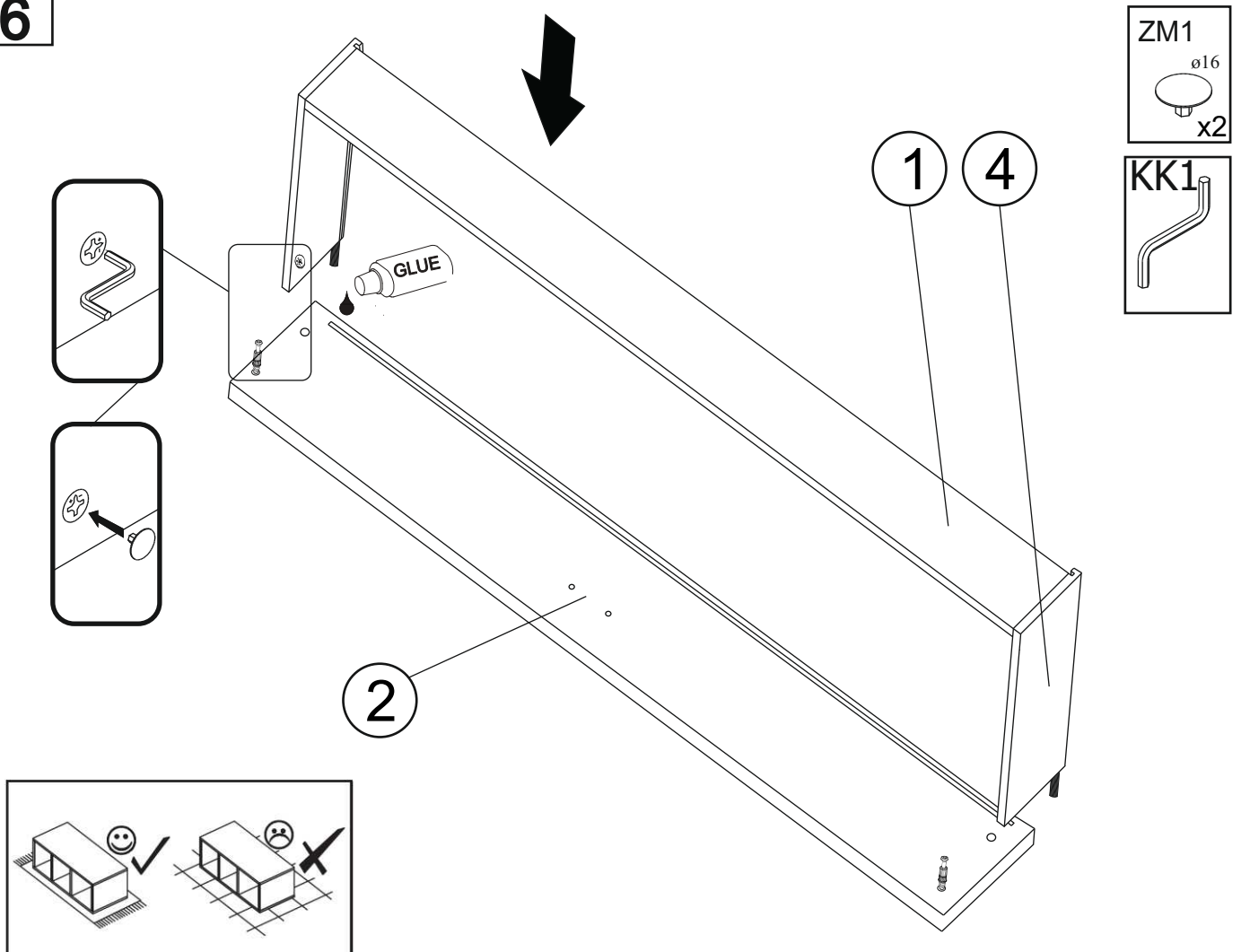

07

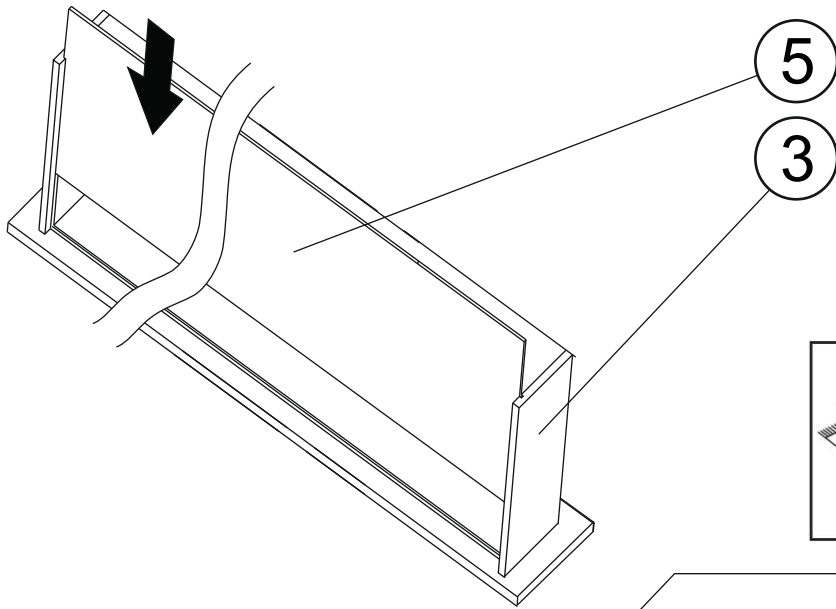

08

a

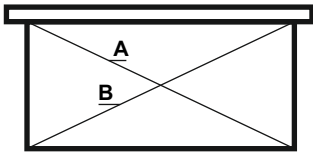

A=B

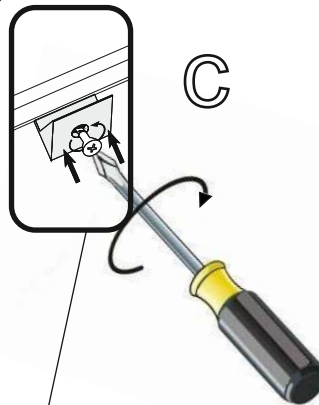
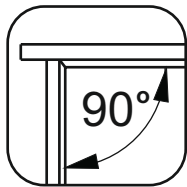

C

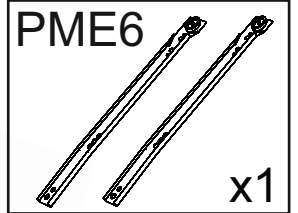

x1

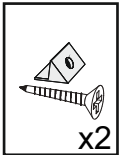

x2

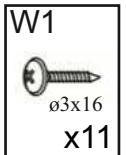

x11

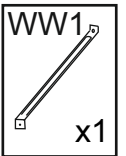

x1

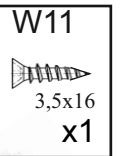

x1

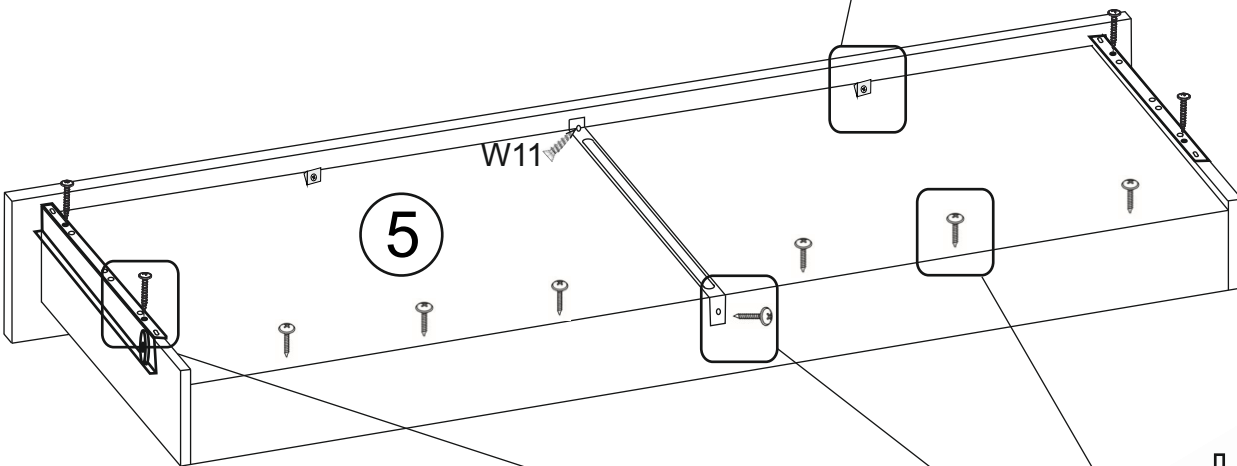

b

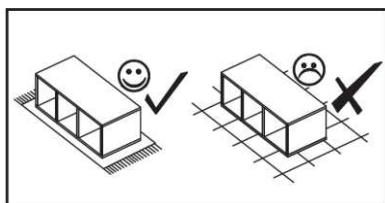
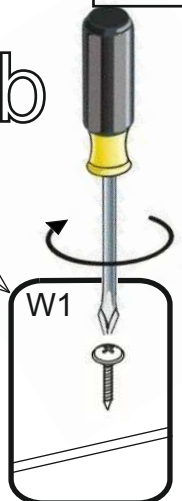

09

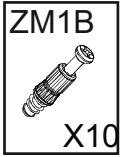
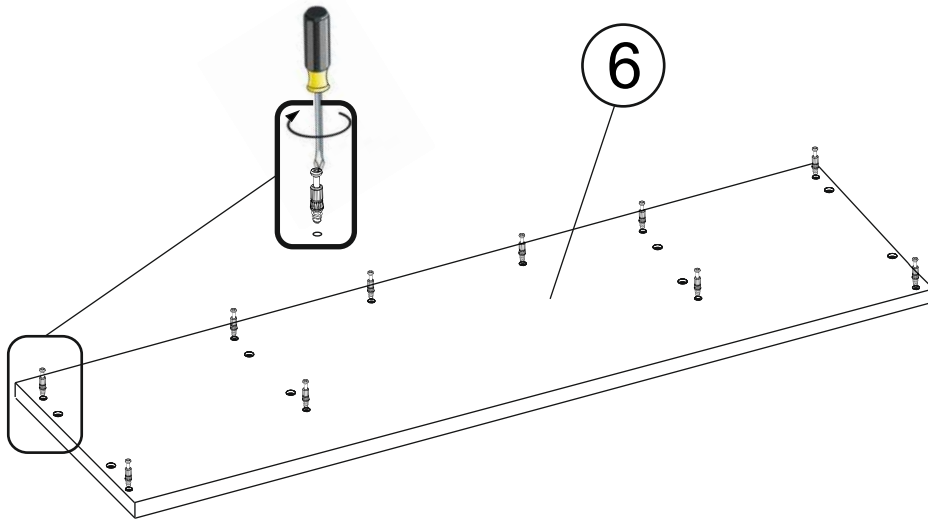

10

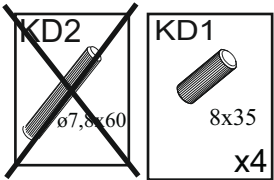
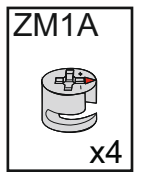
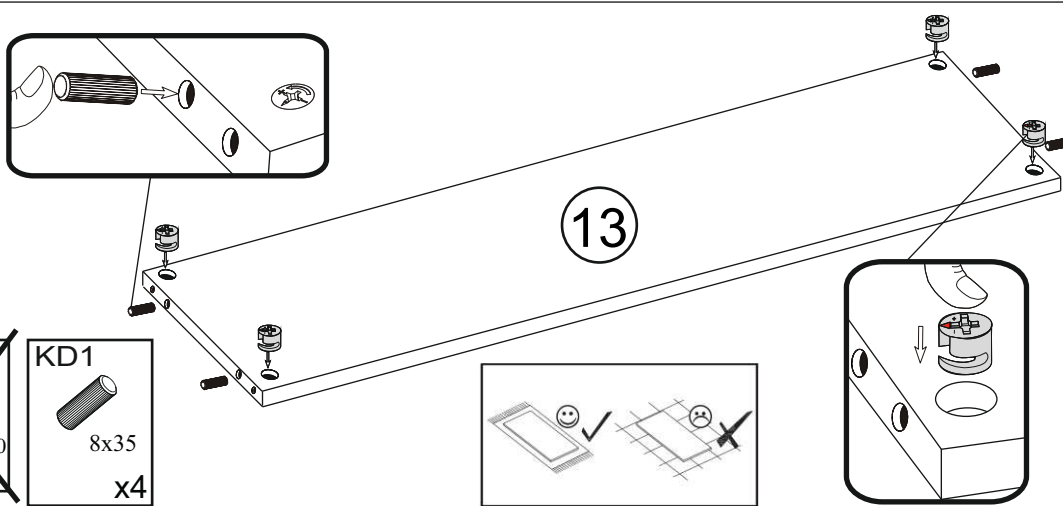

11

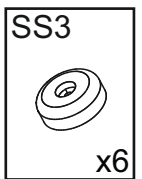
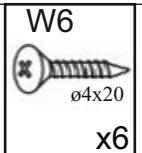
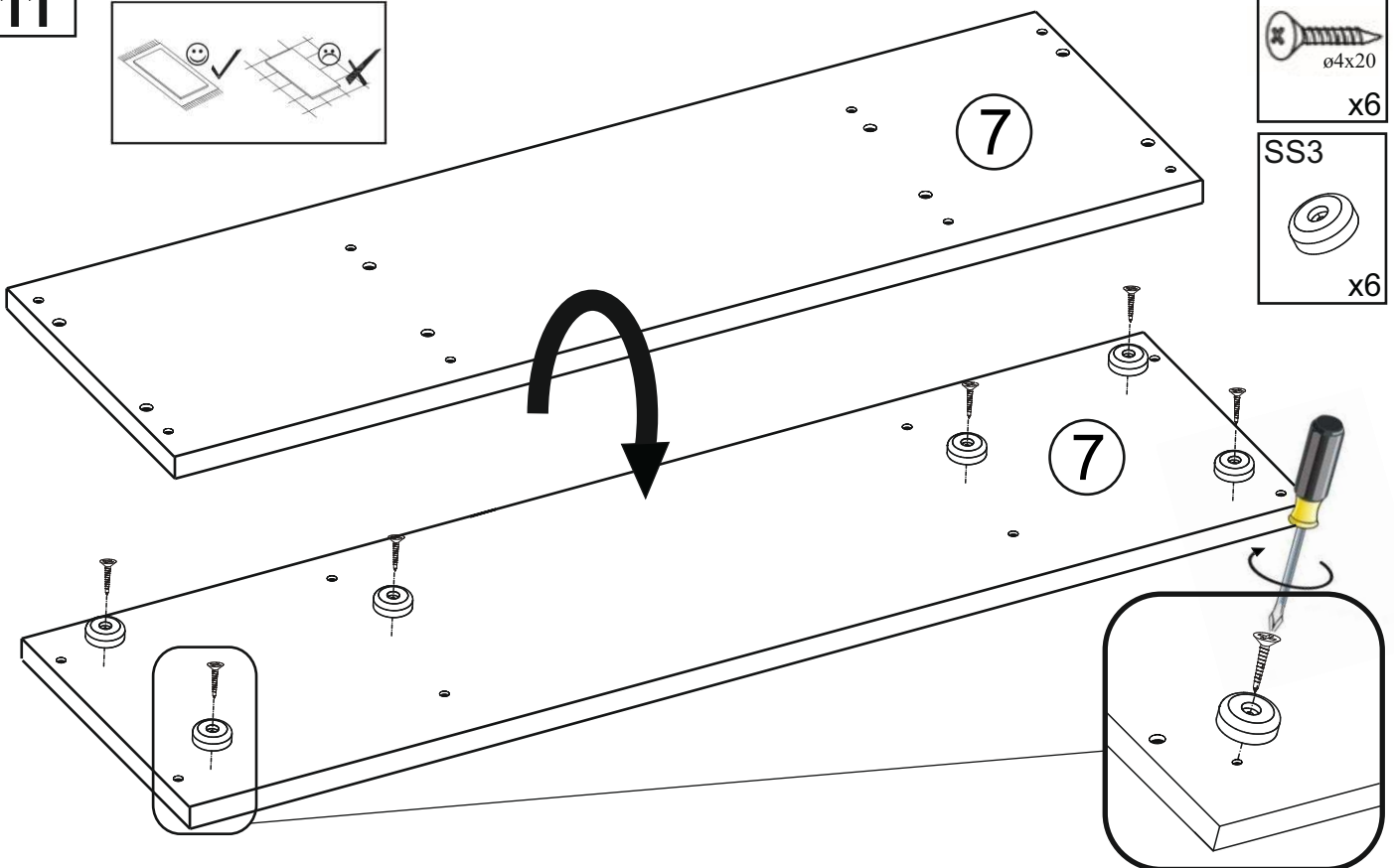
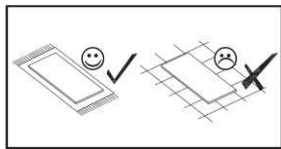

12

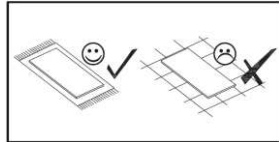
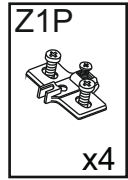
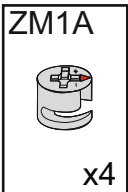
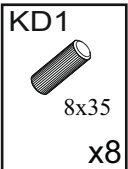
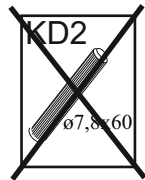
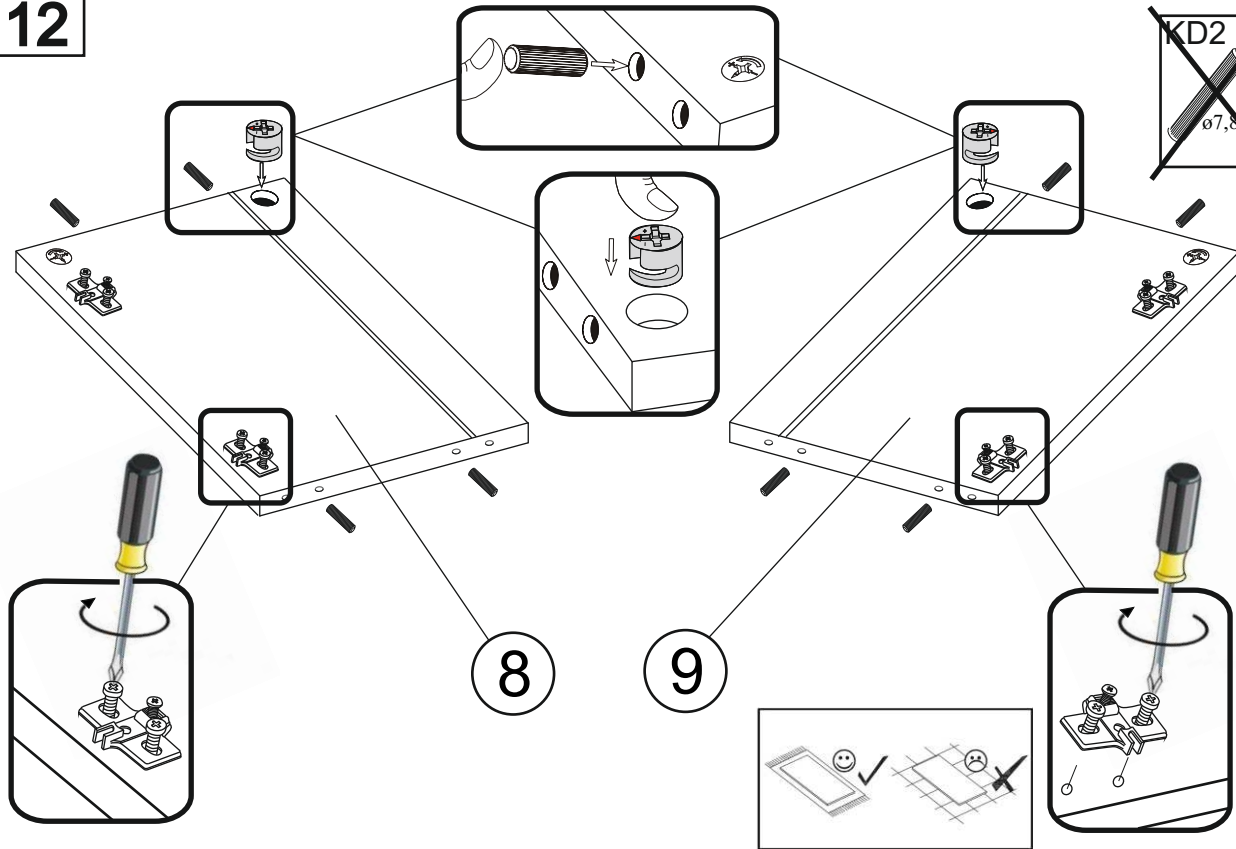

13

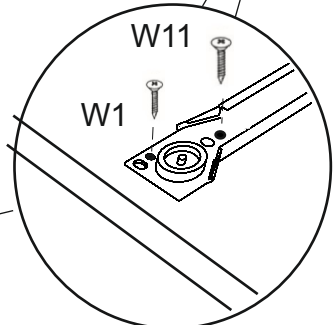
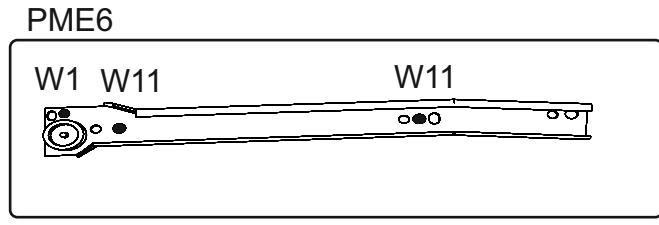
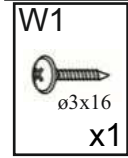
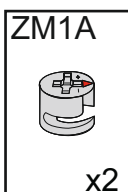
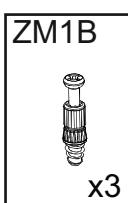
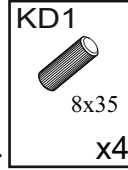
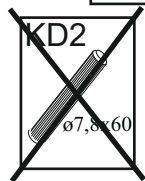
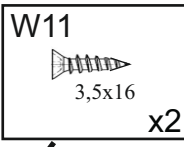
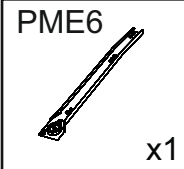
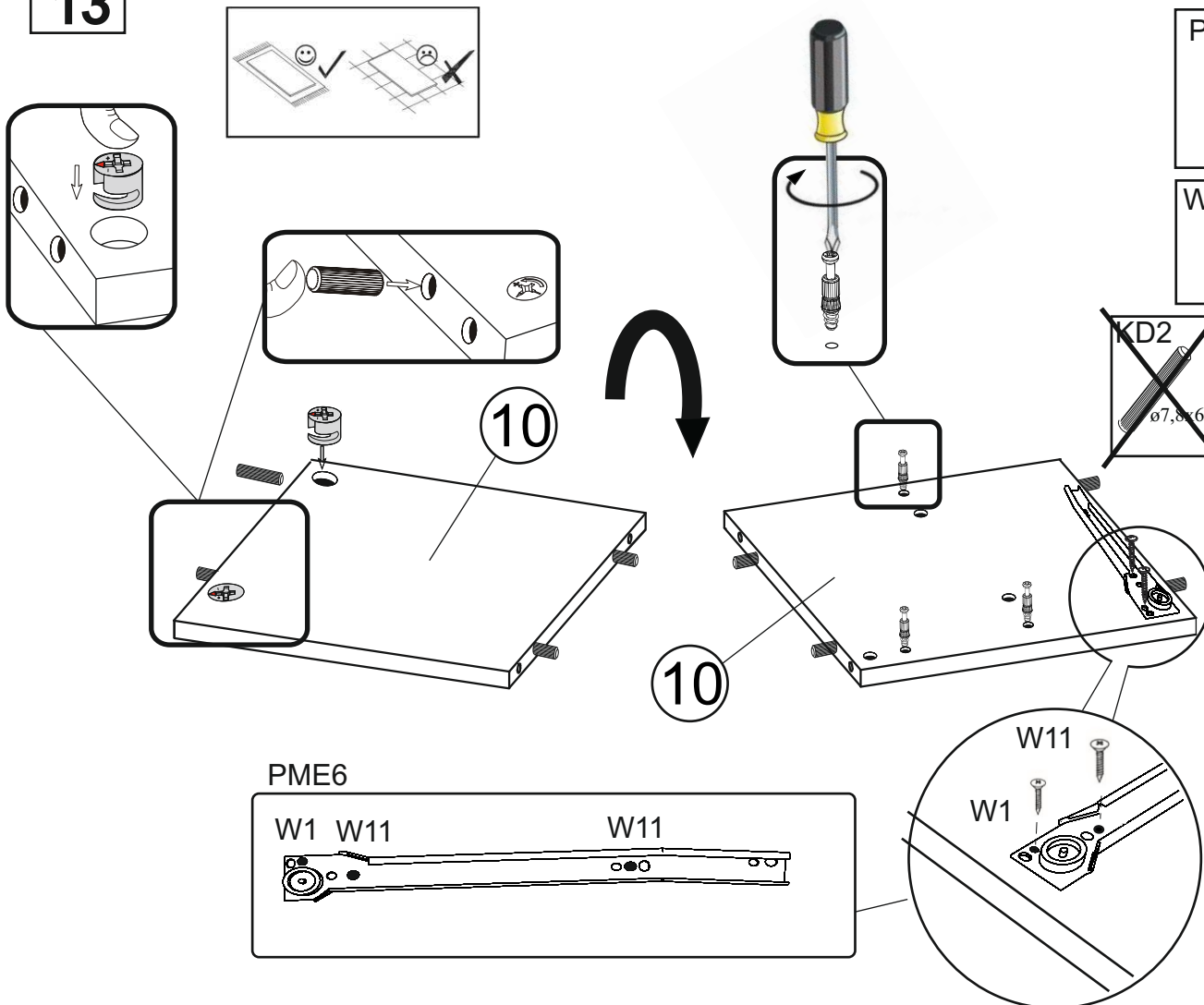

10

14

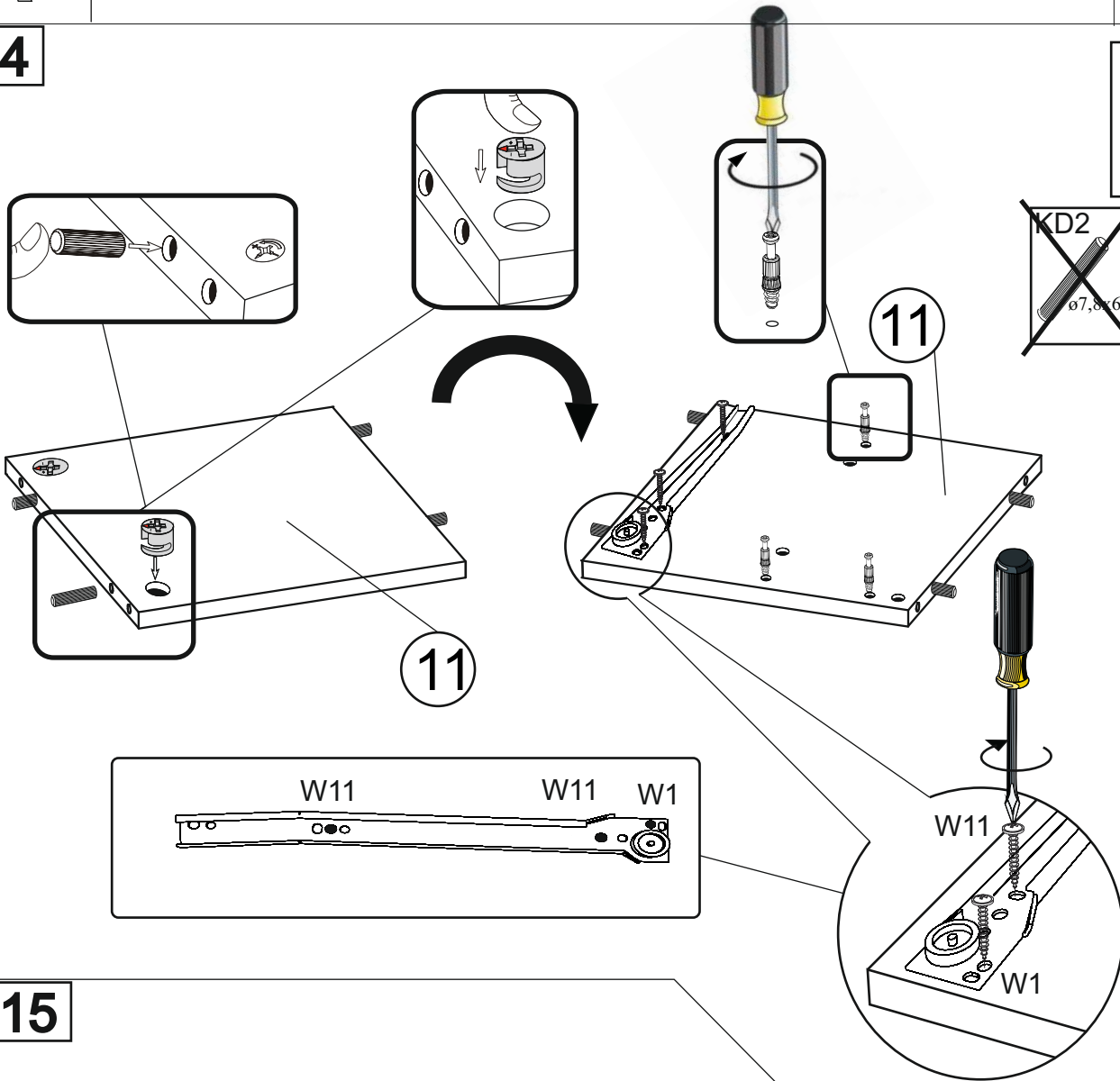

PME6
x1

~~KD2~~
ø7,8x60

KD1
8x35
x4

ZM1A
x2

ZM1B
x3

W1
ø3x16
x1

W11
3,5x16
x2

15

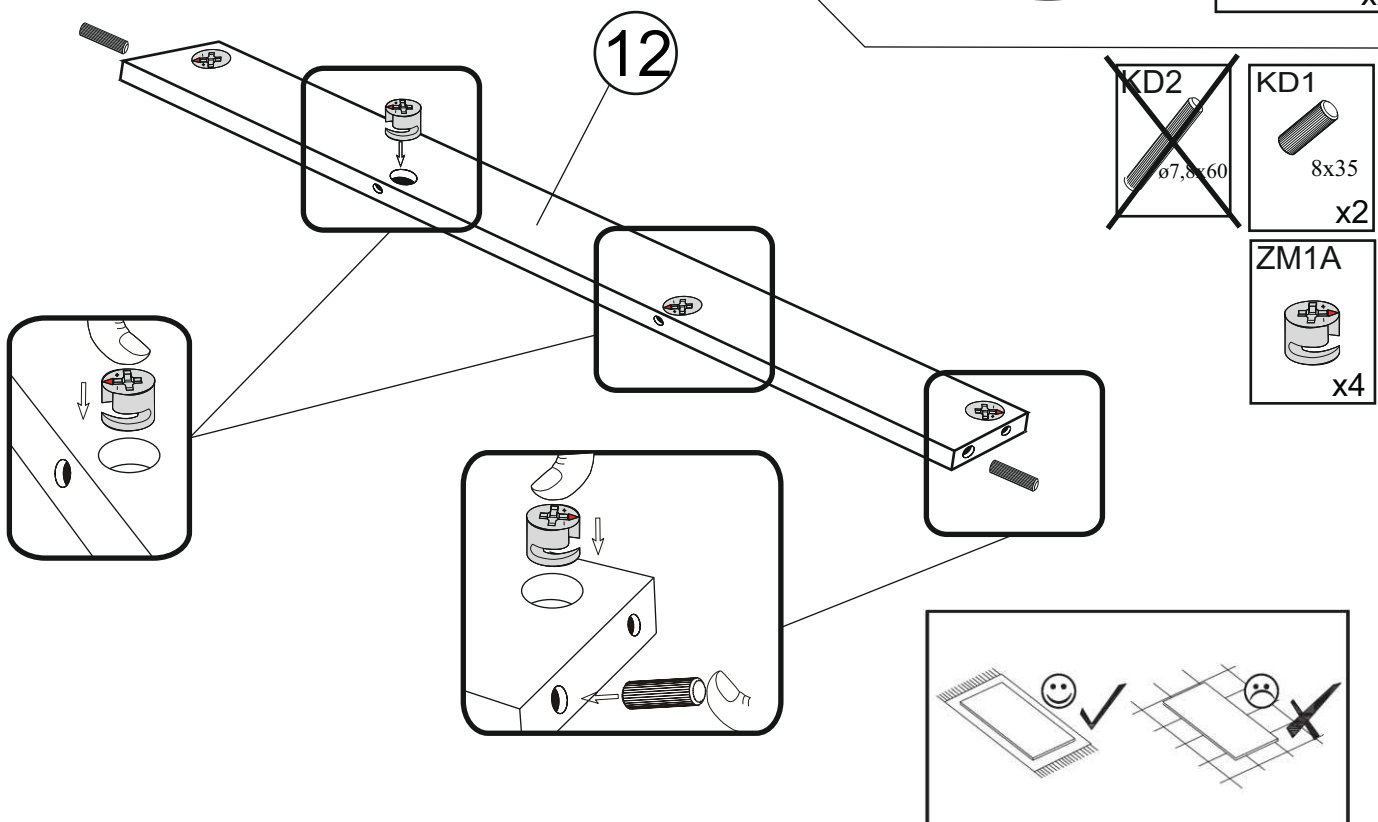

~~KD2~~
ø7,8x60

KD1
8x35
x2

ZM1A
x4

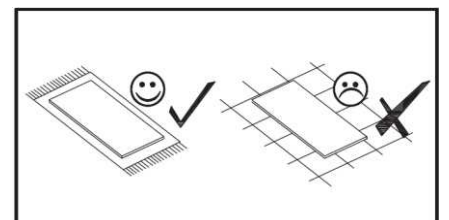

16

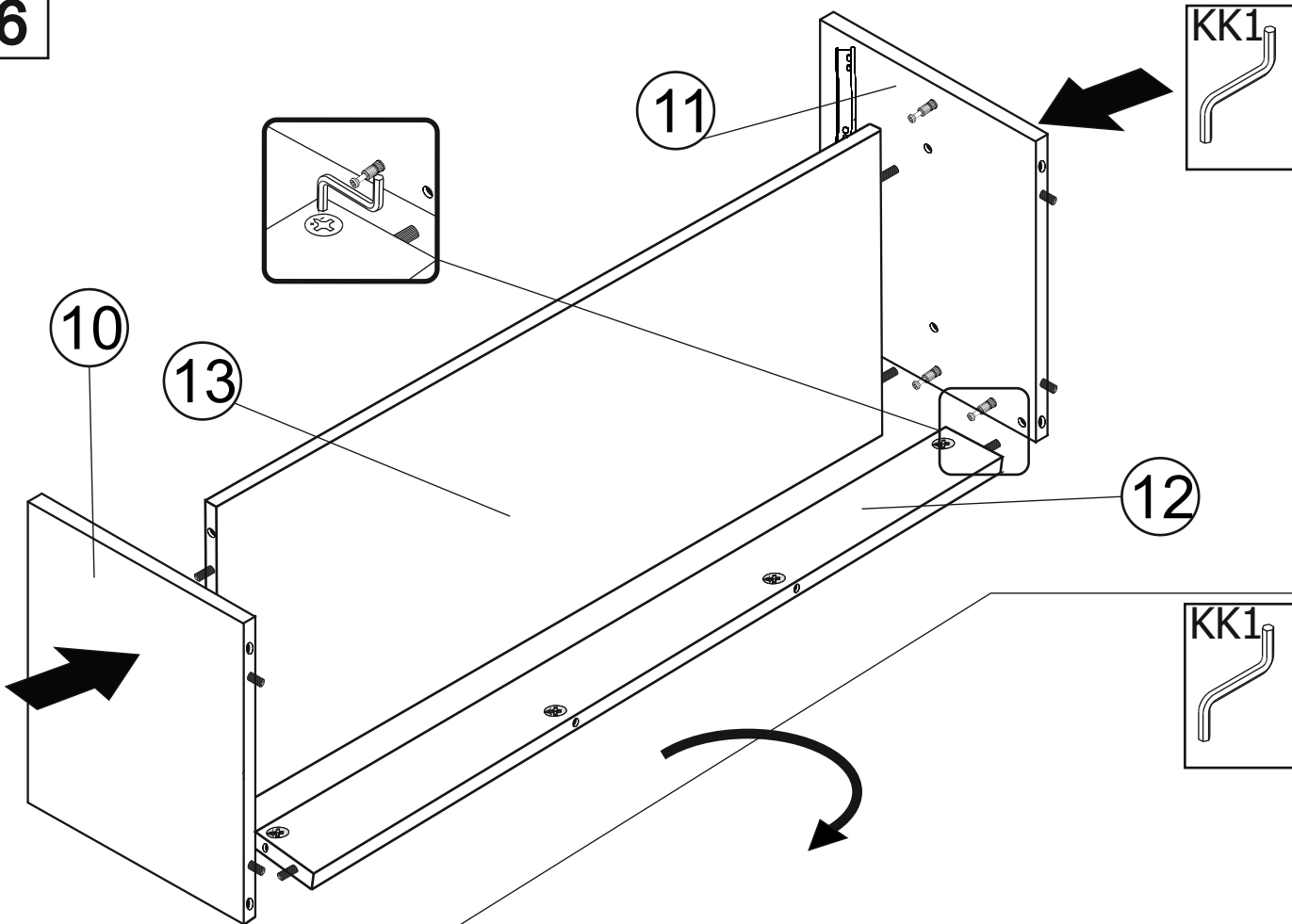

17

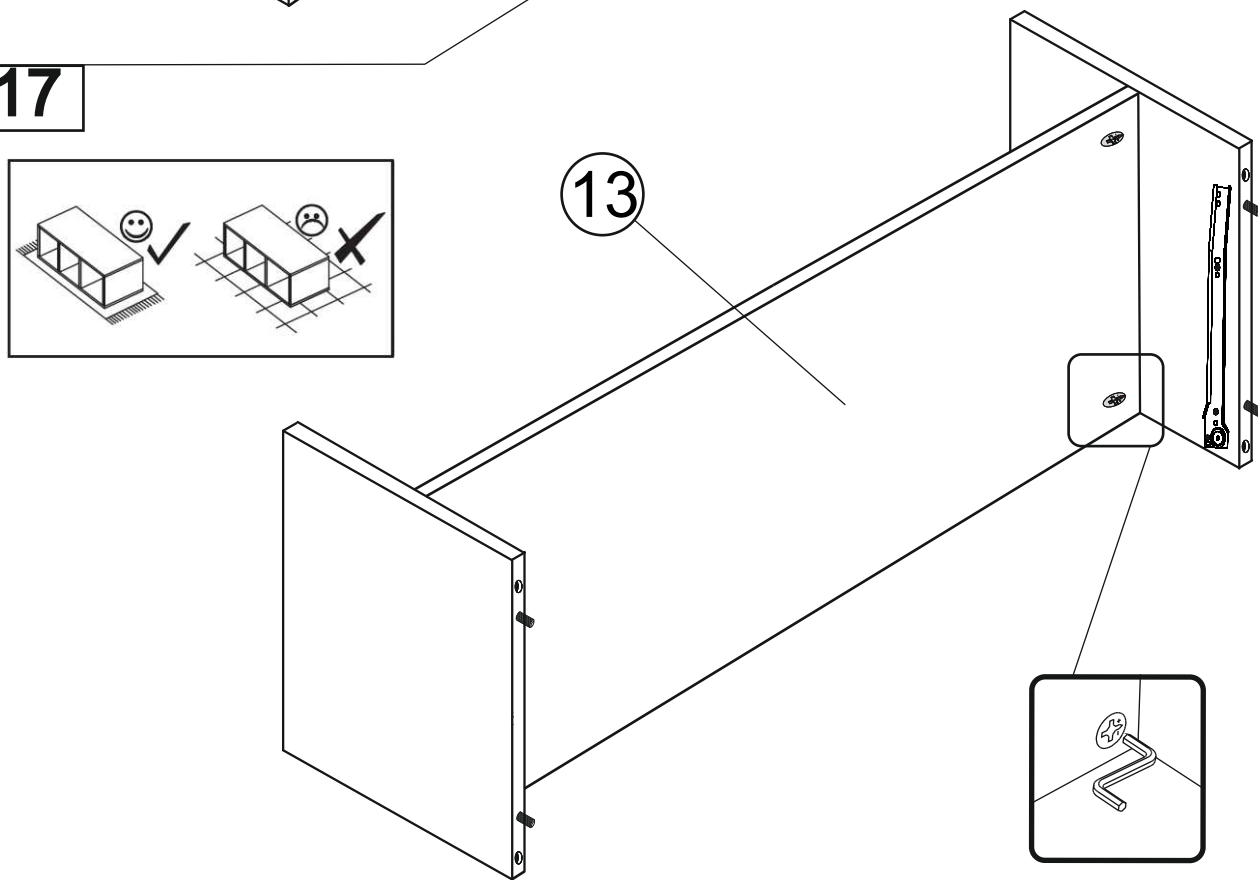

A

VULCAN ANBAUWAND

13/32

20

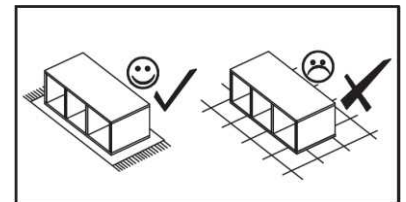
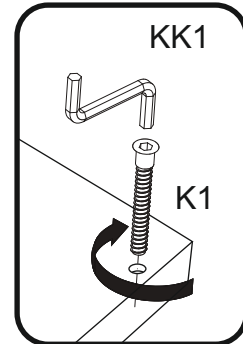
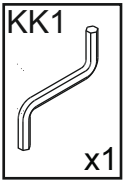
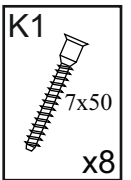
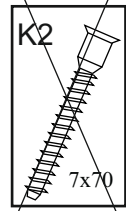
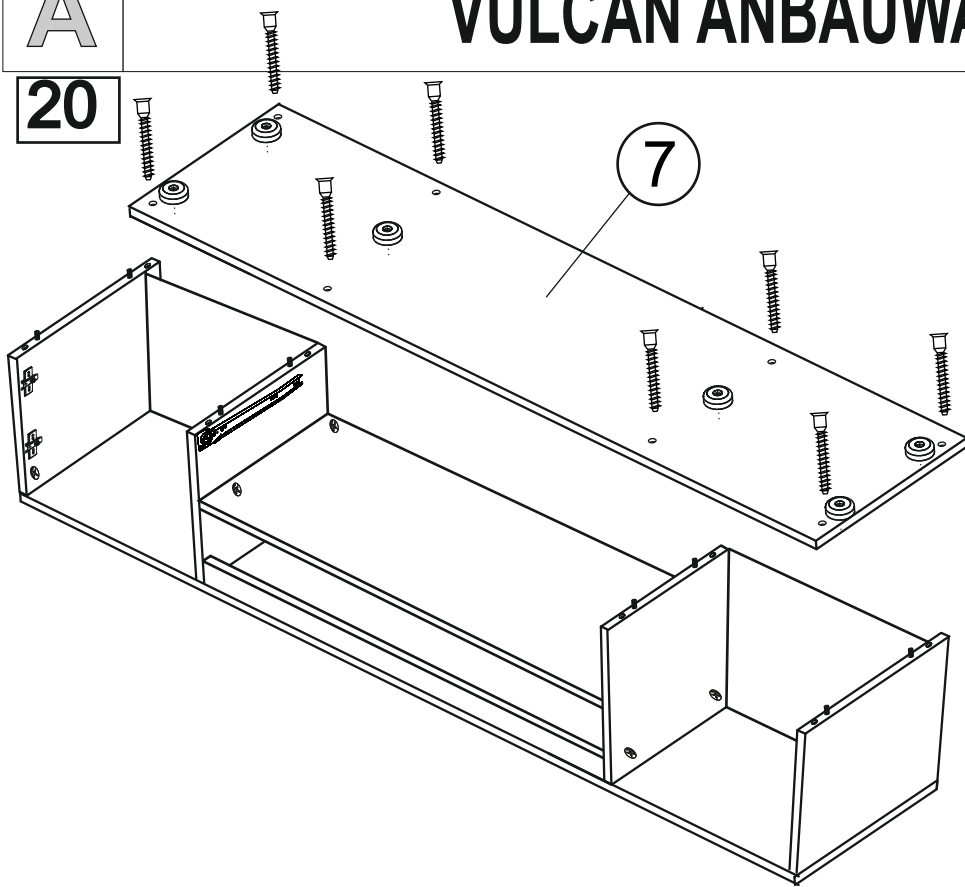

21



A=B

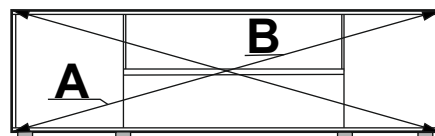

W1

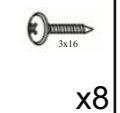

S1

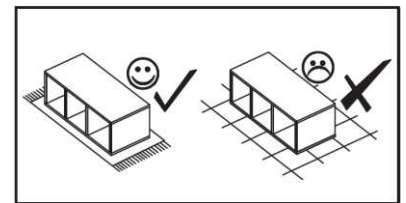
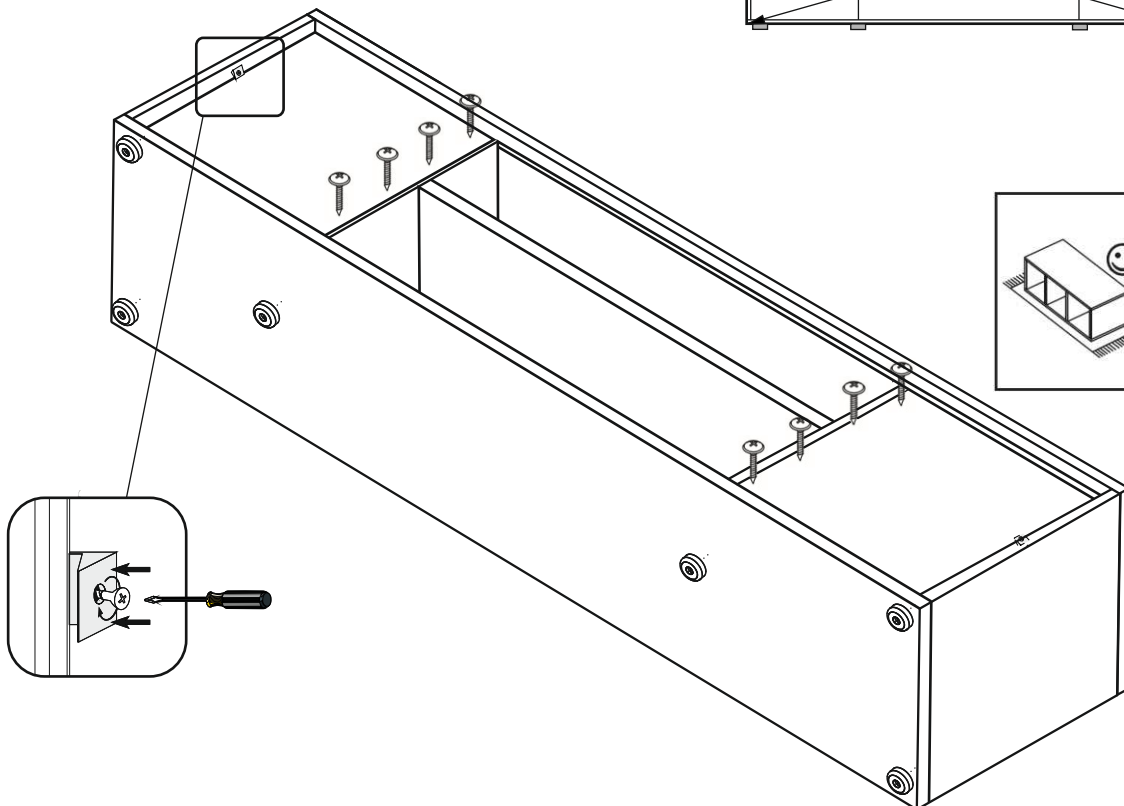
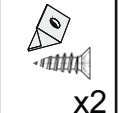

22

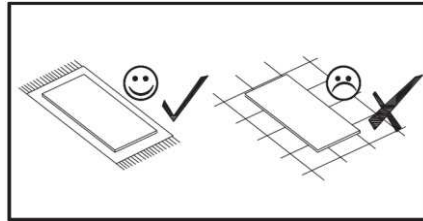
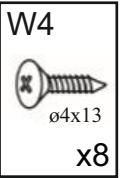
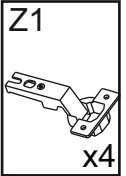
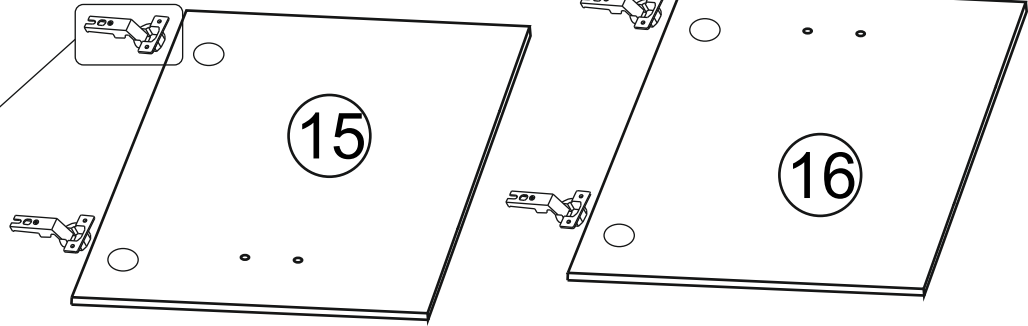
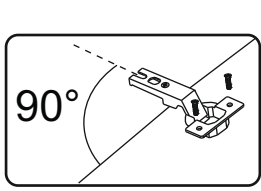

23

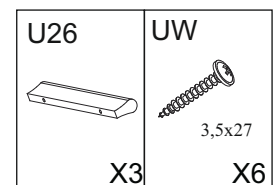
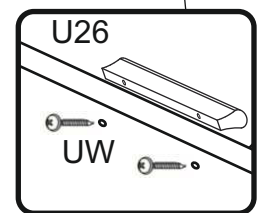
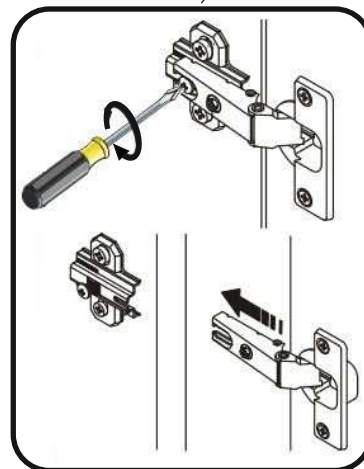
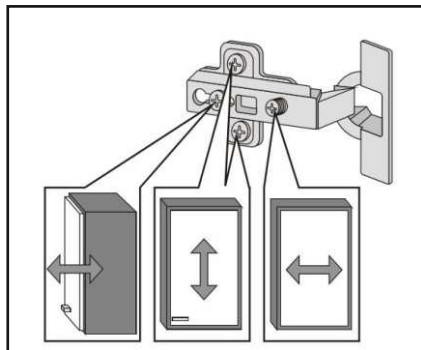
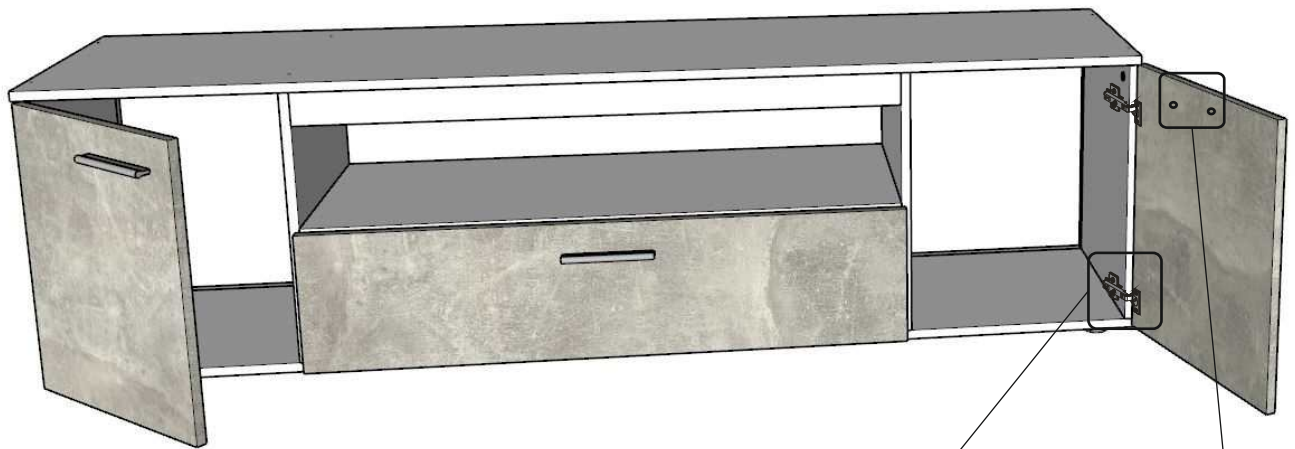

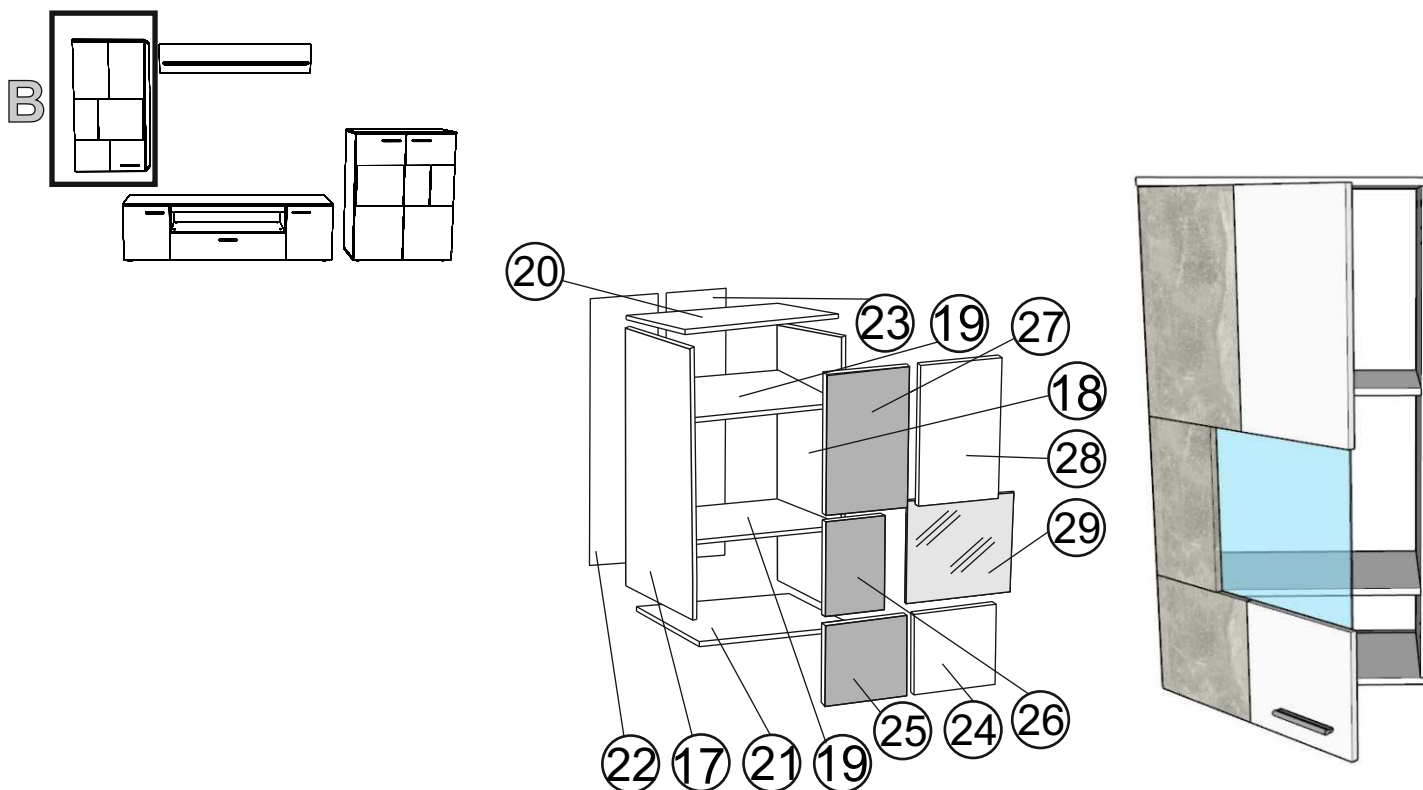

24

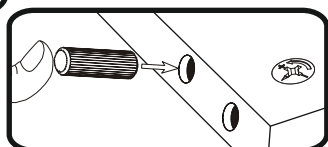
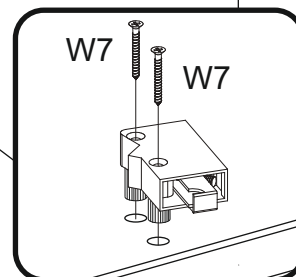
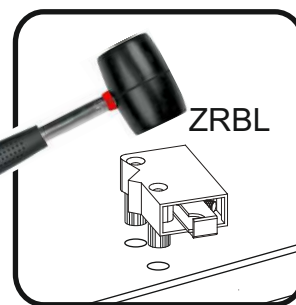
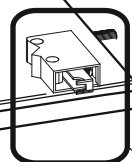
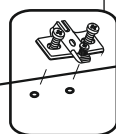
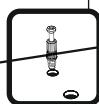
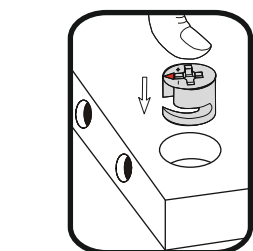
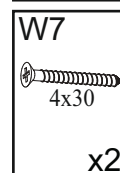
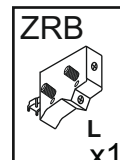
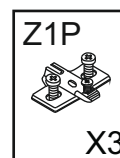
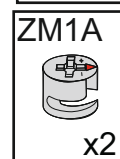
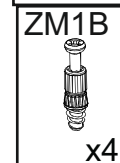
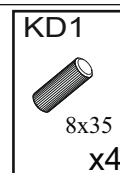
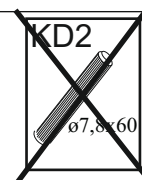
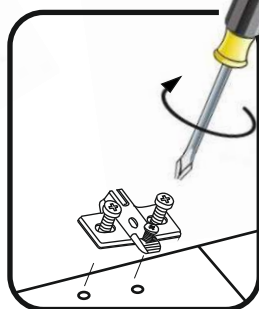
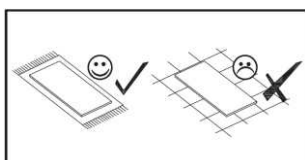

17

27

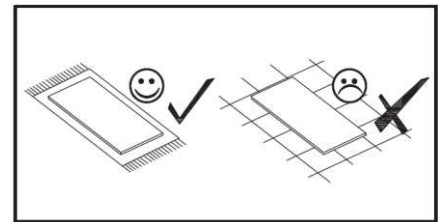
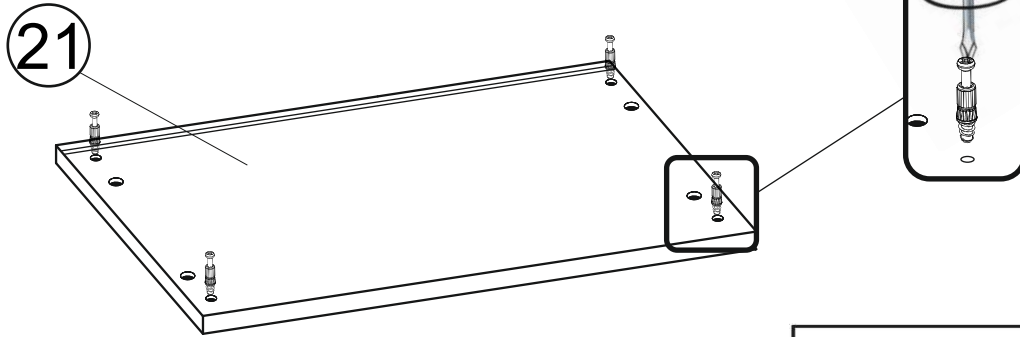

28

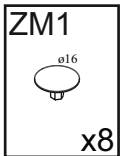
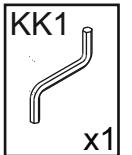
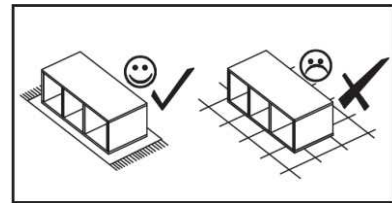
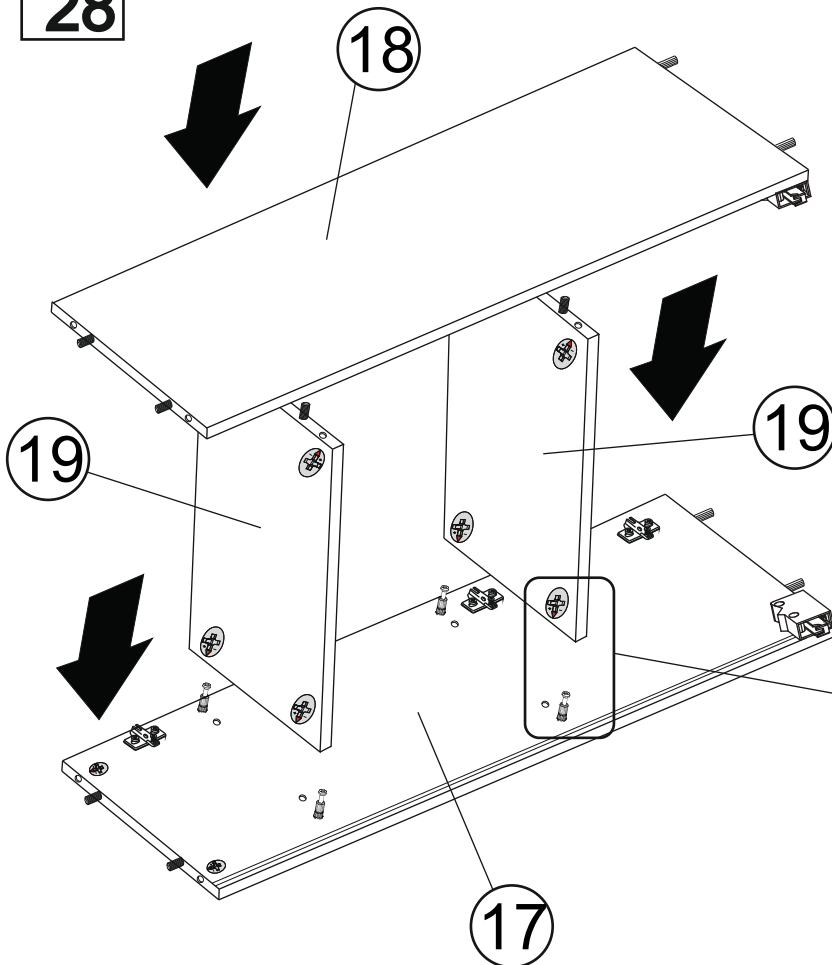

29

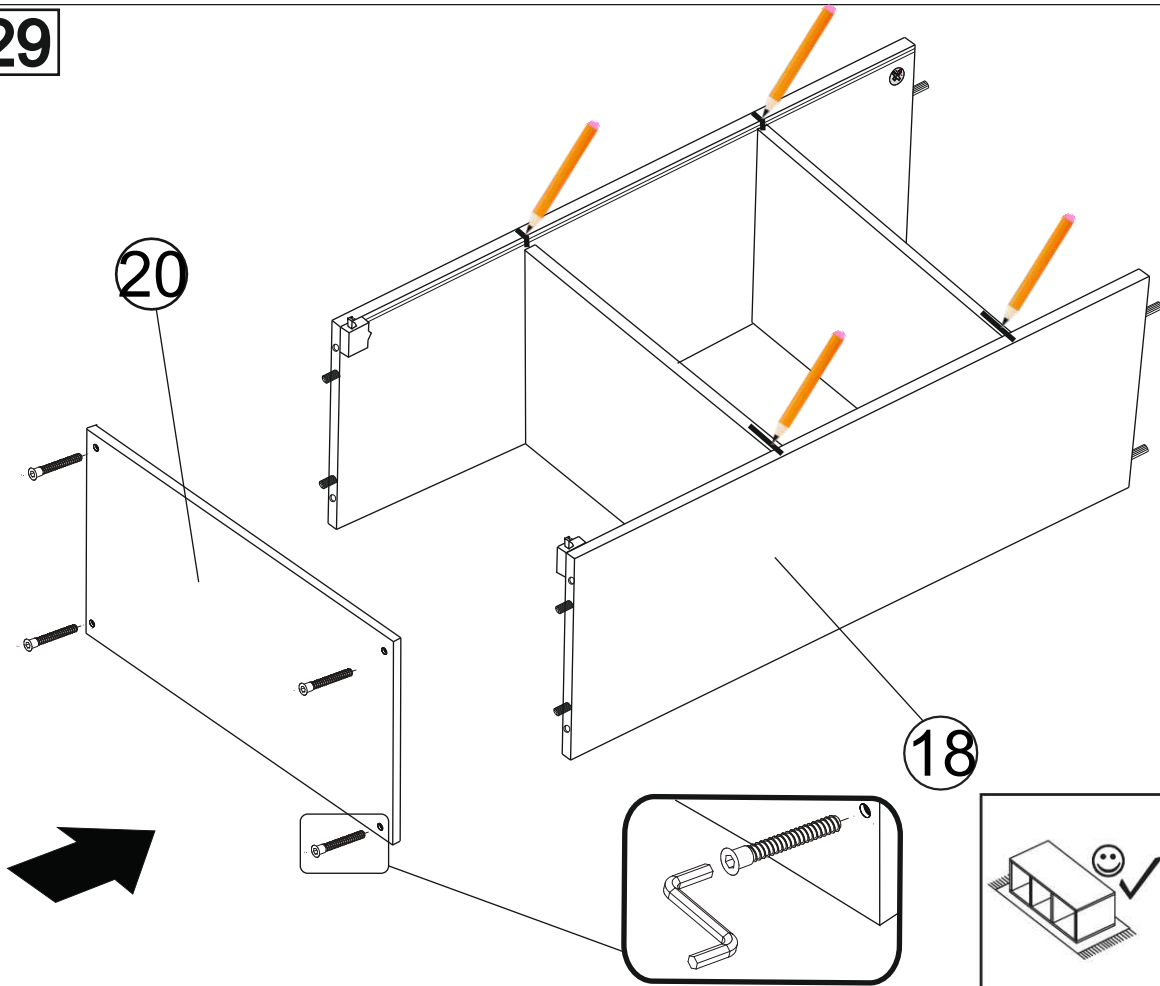

- KK1 x1
- K1 7x50 x4
- ZK1 $\varnothing 11$ x4

30

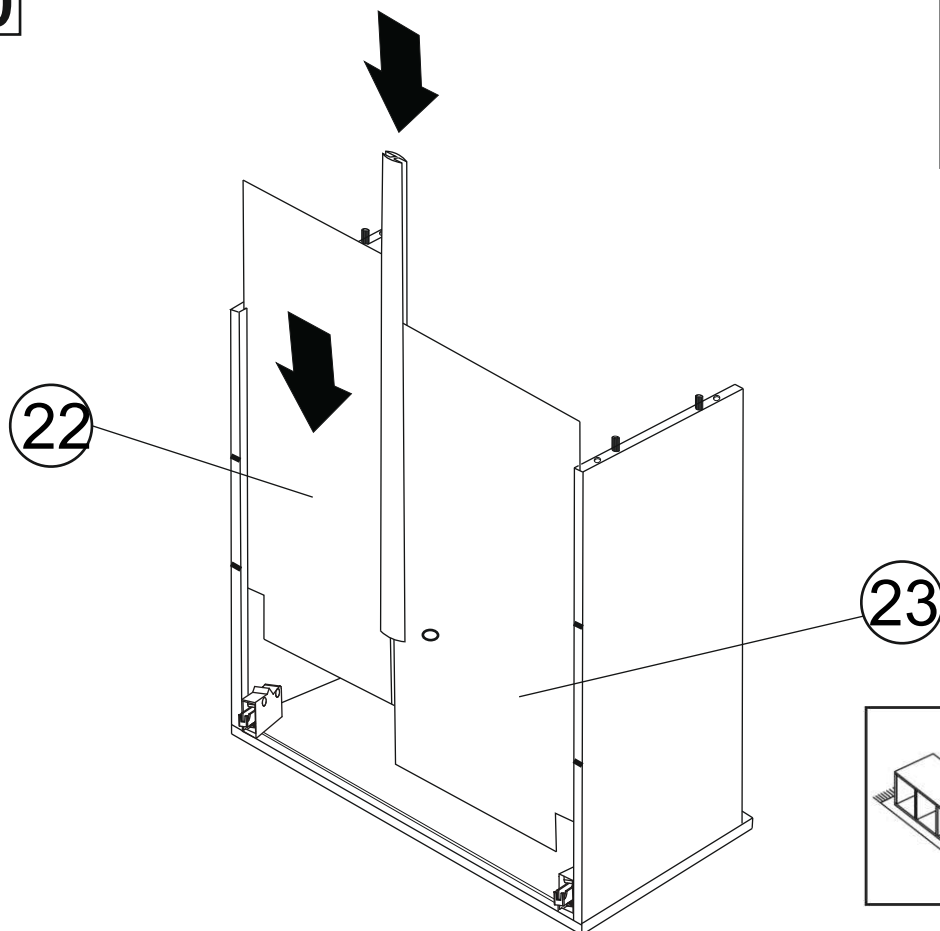

- LI L-1078 x1

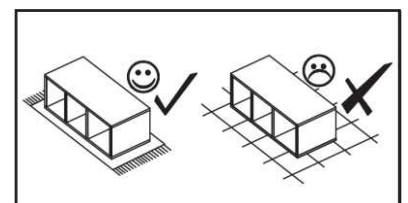

31

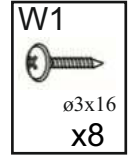
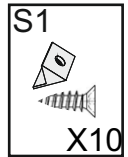
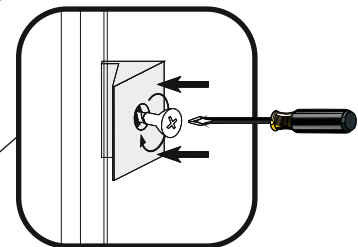
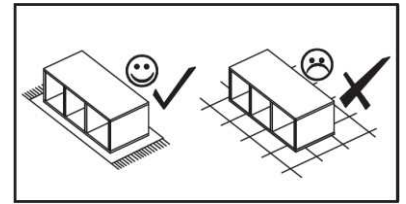
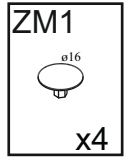
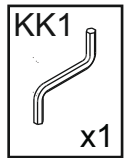
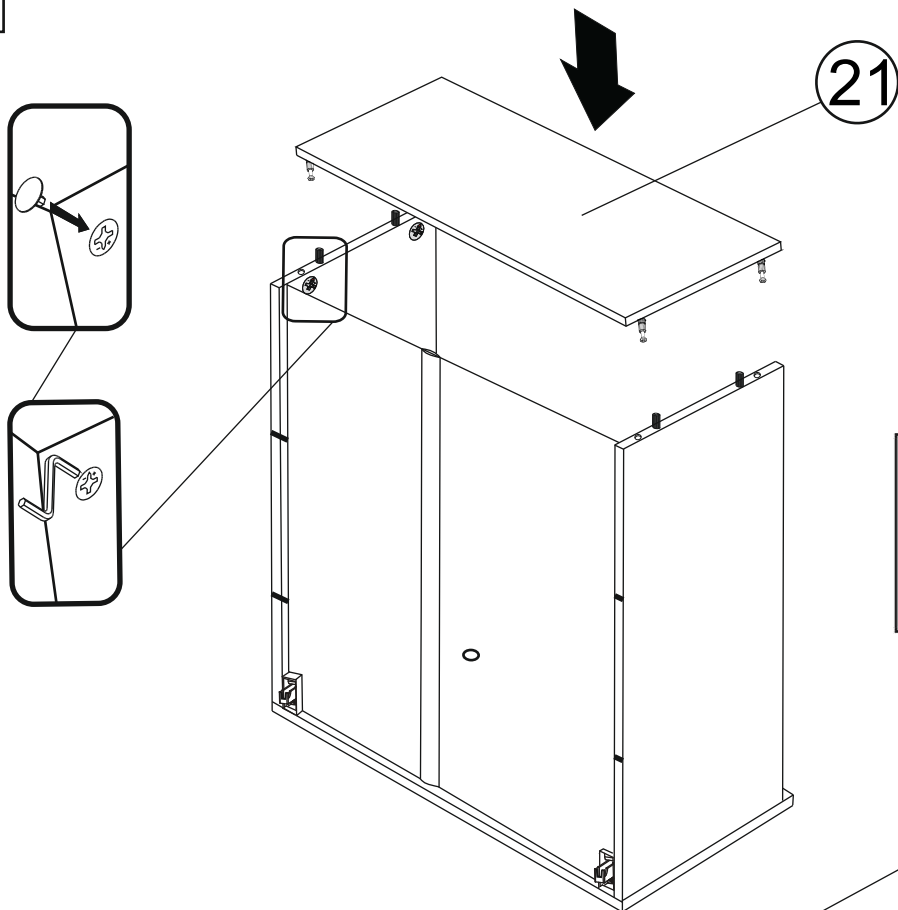

32

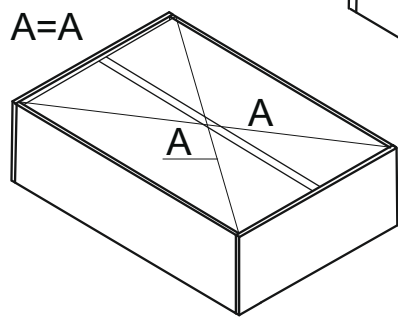
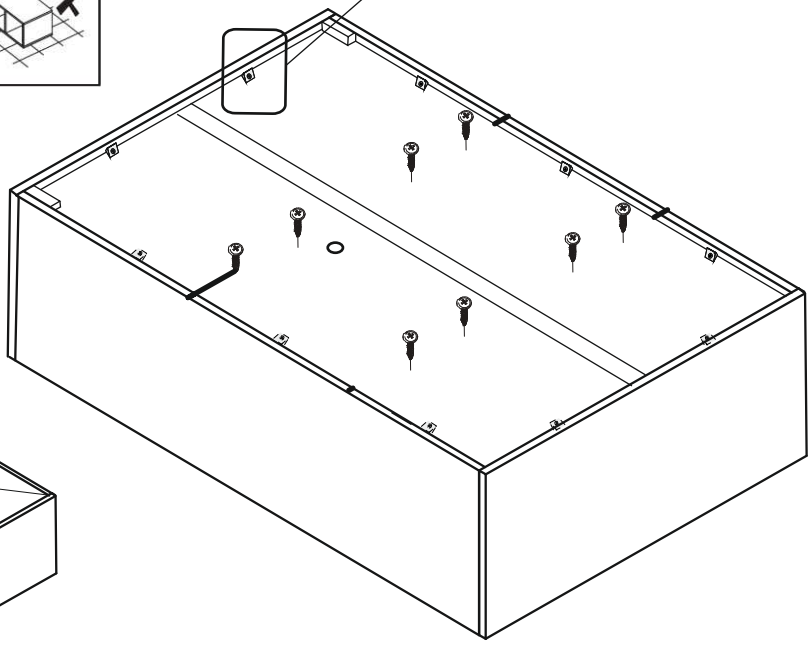
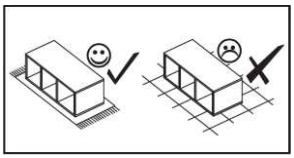

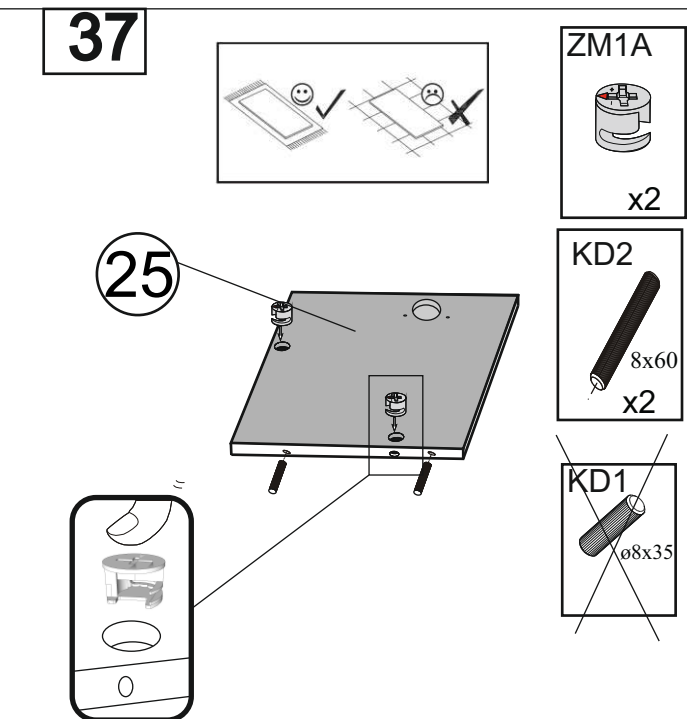
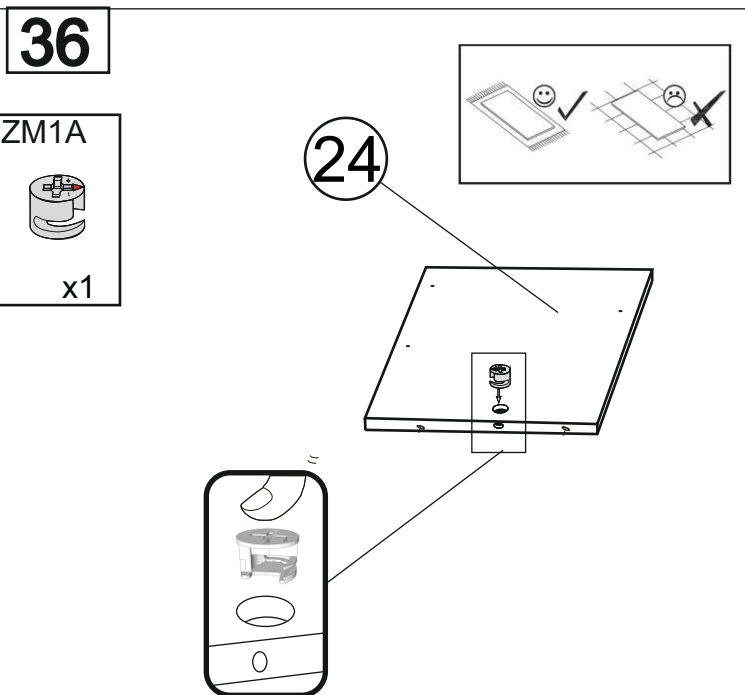
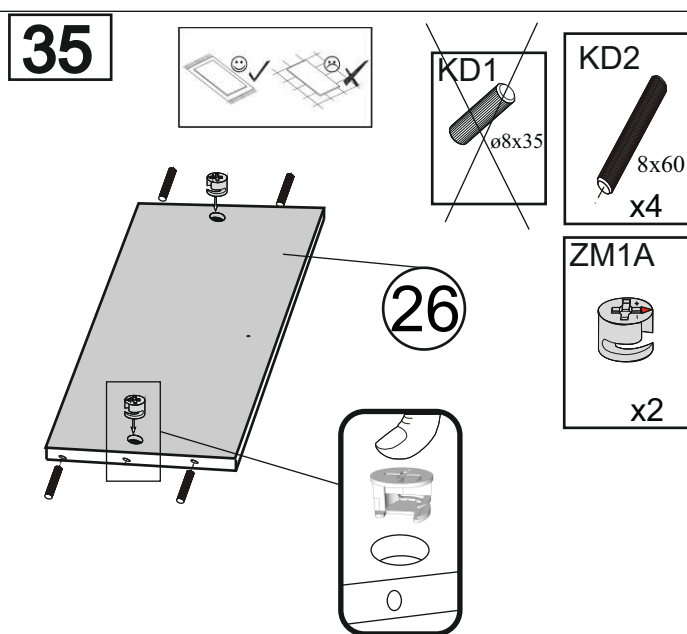
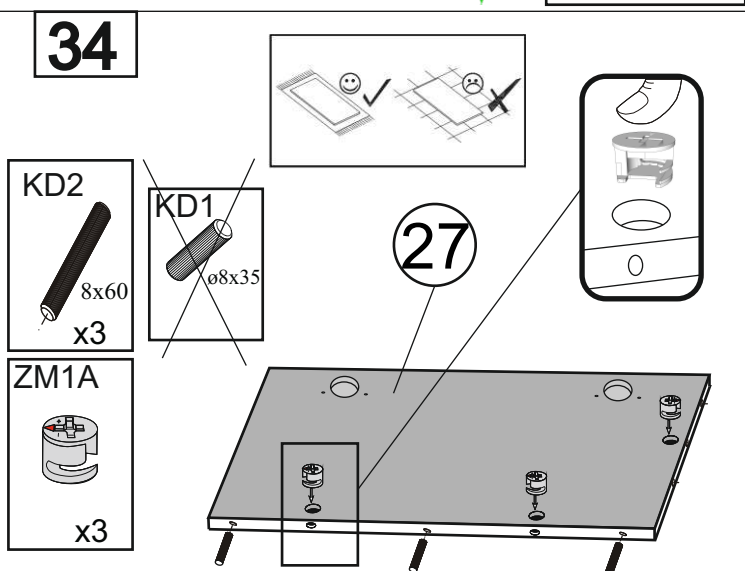
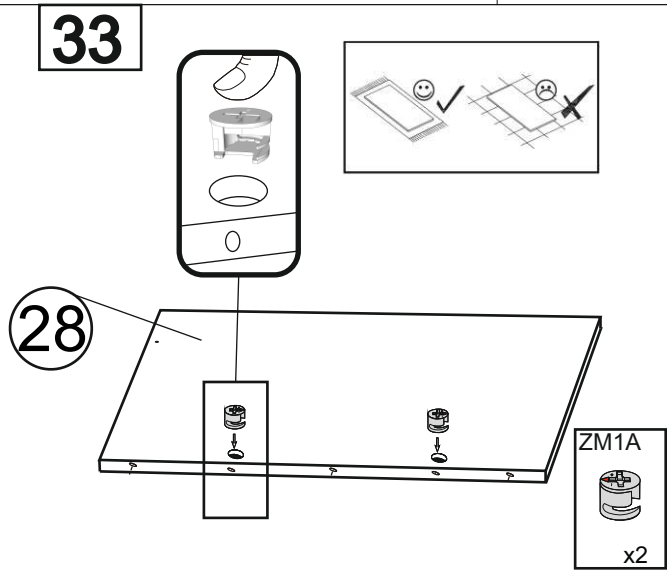
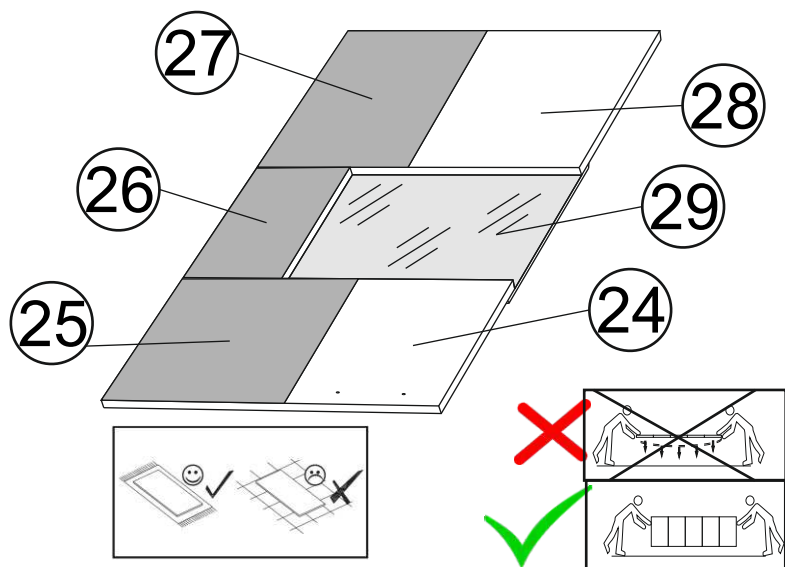

38

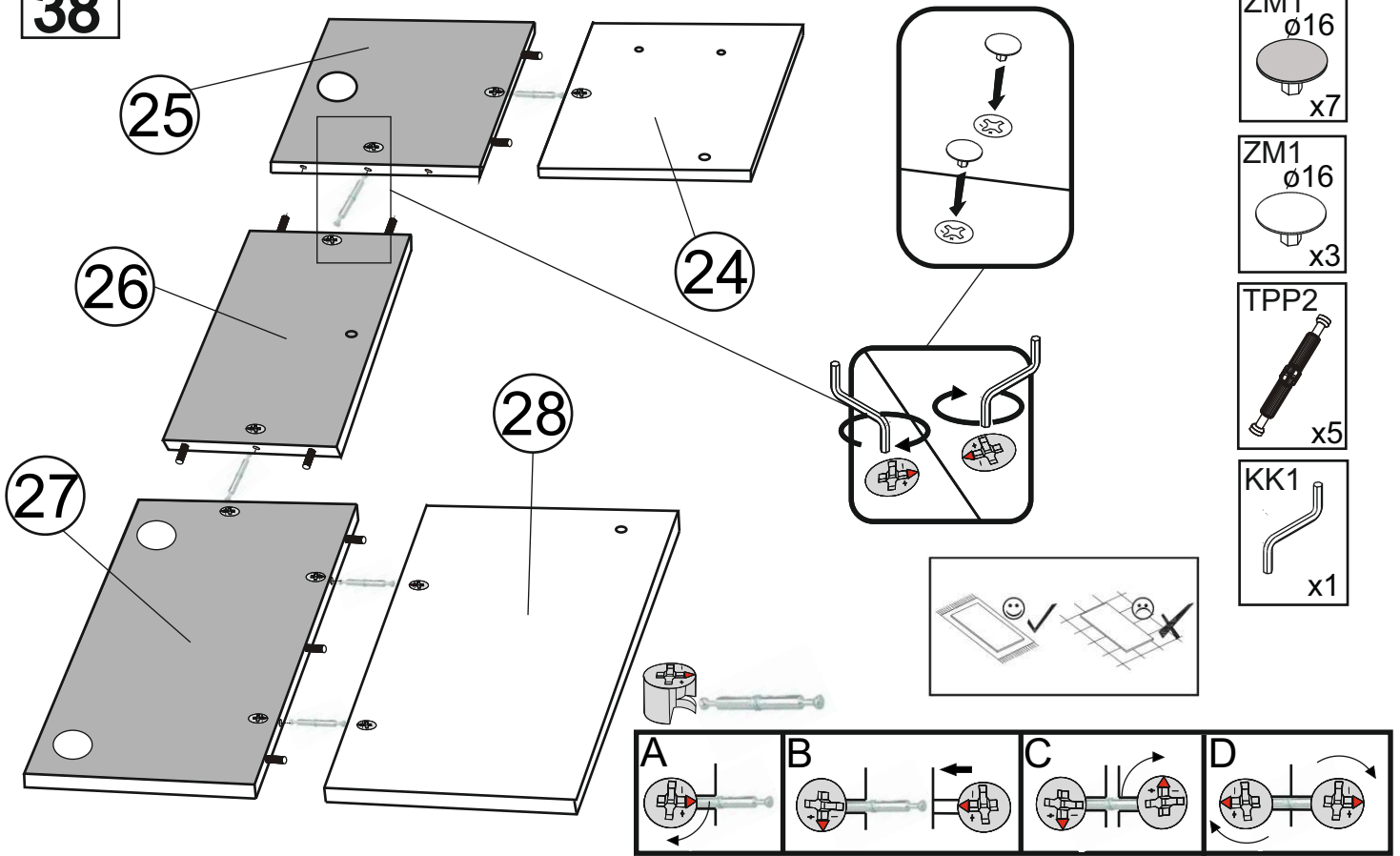

39

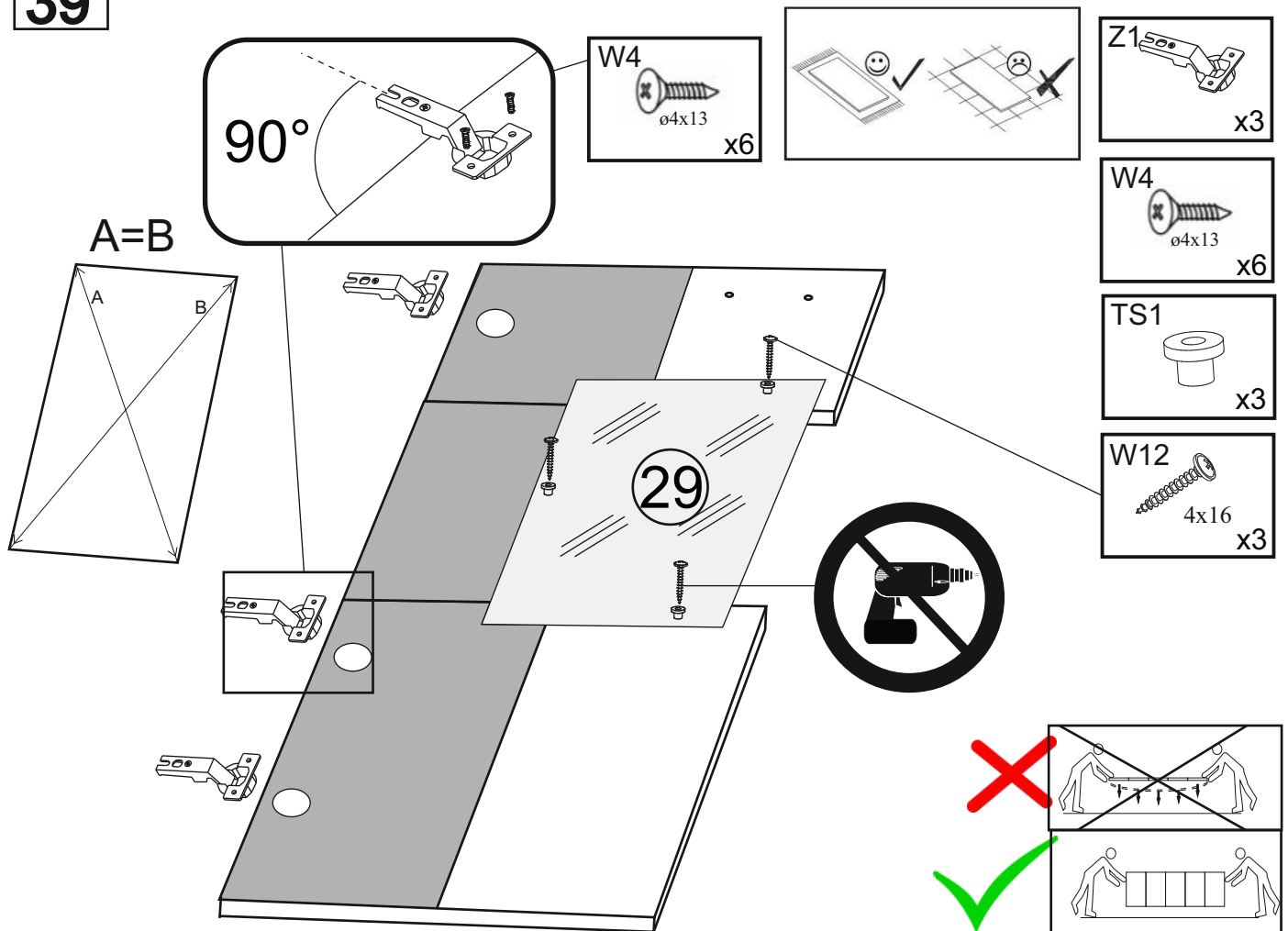

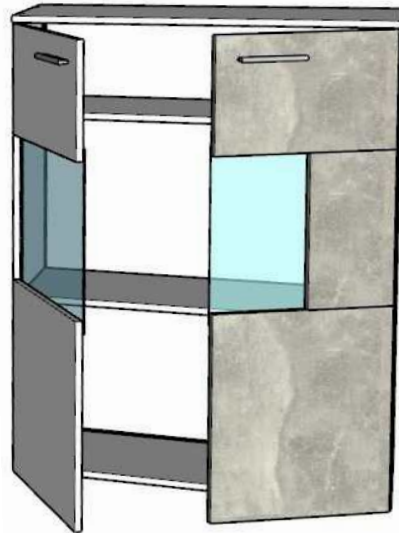
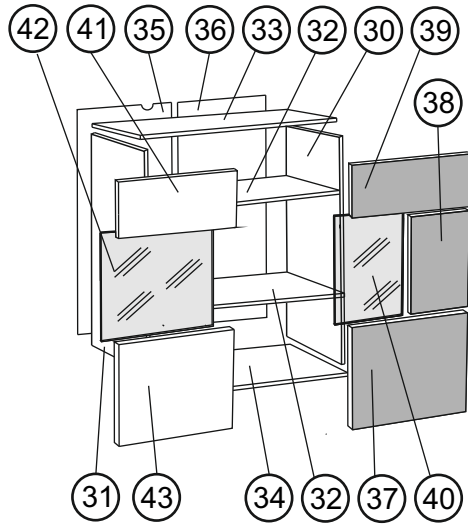
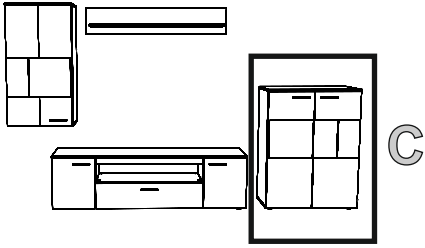

40

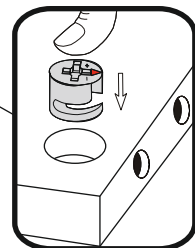
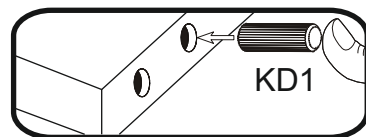
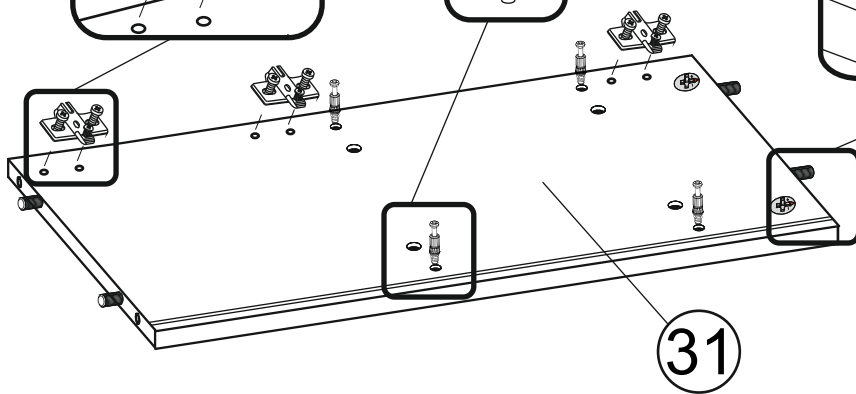
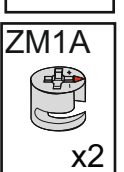
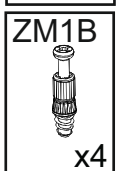
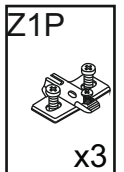
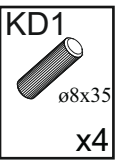
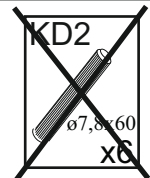
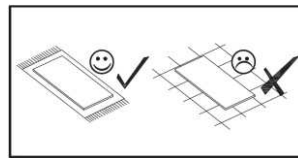
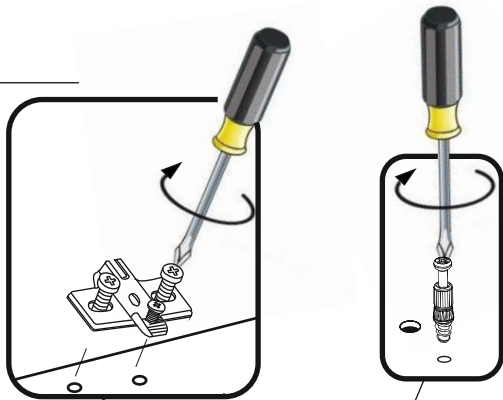

31

41

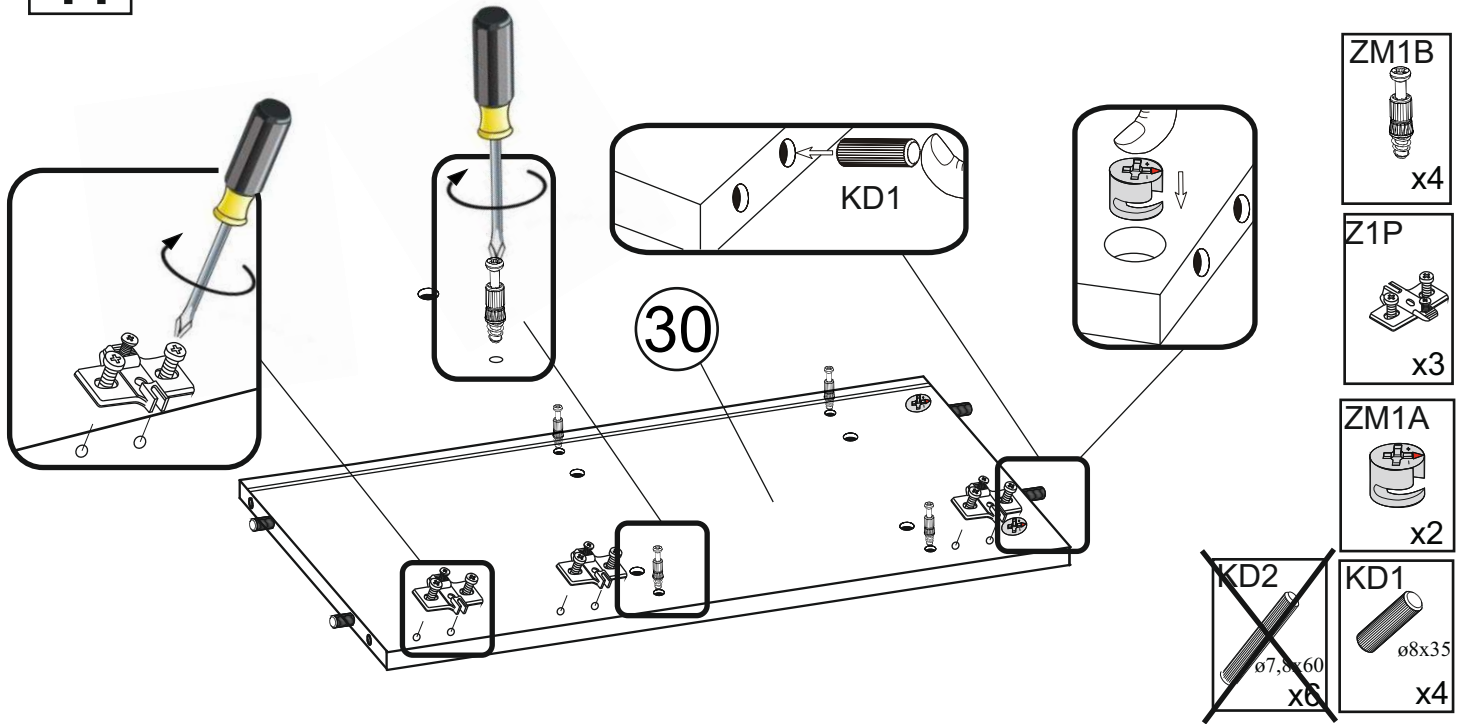

42

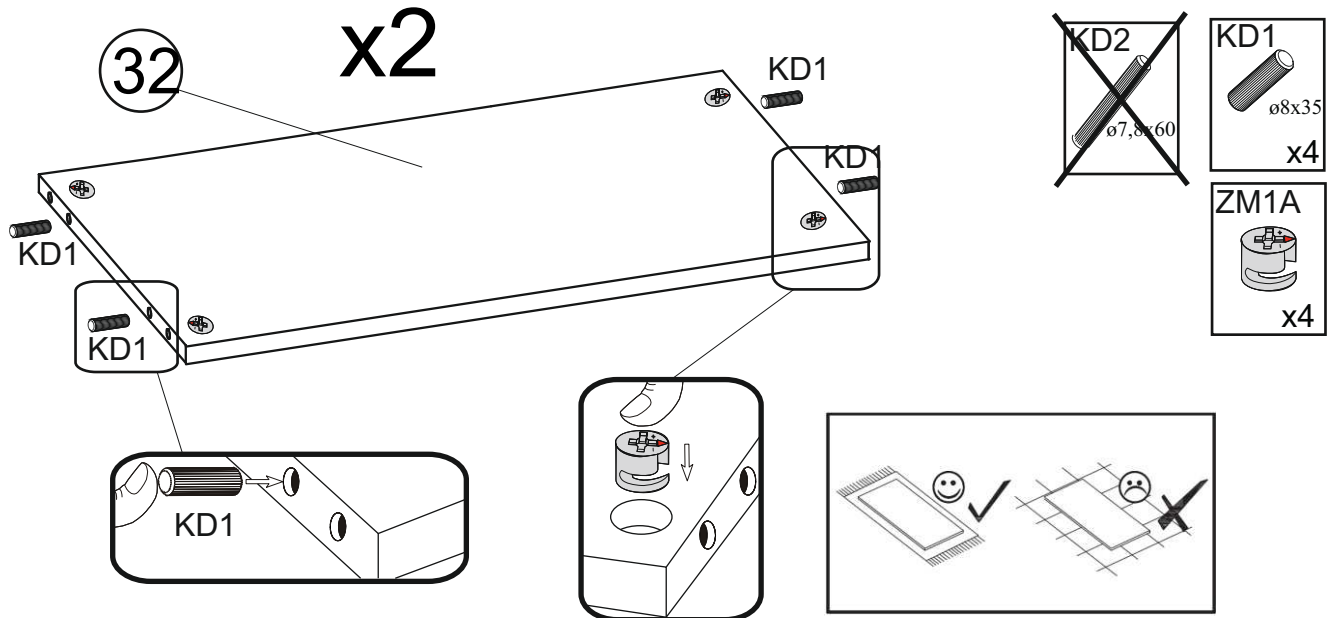

43

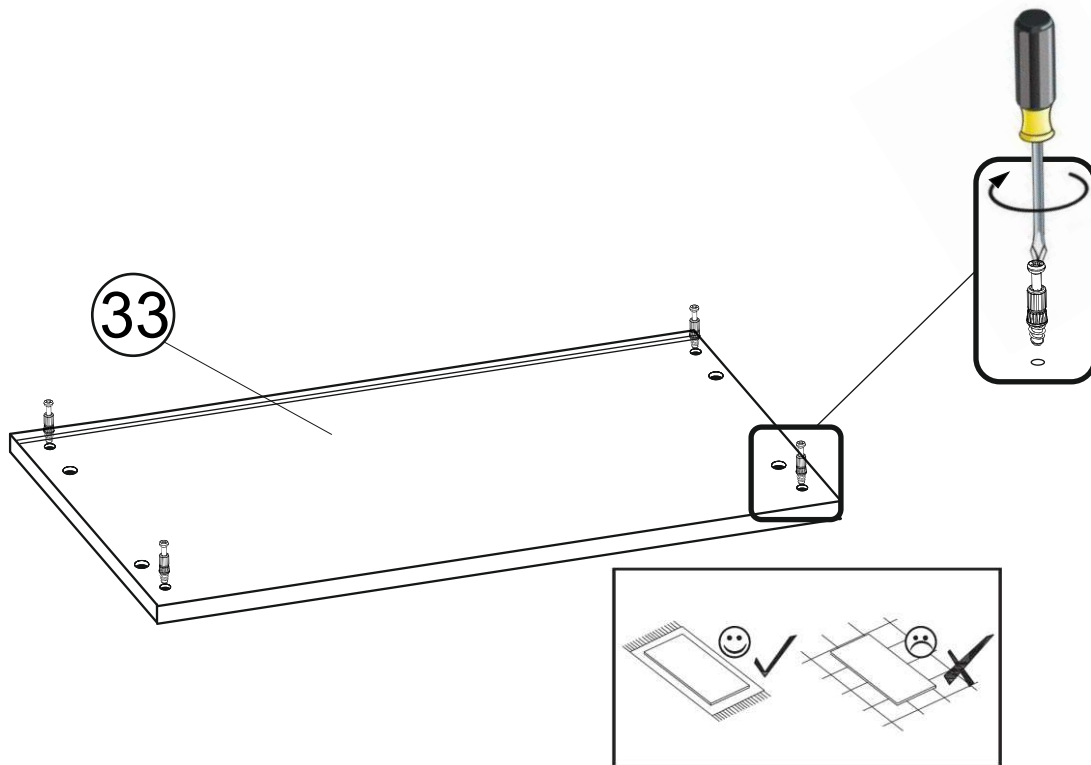

44

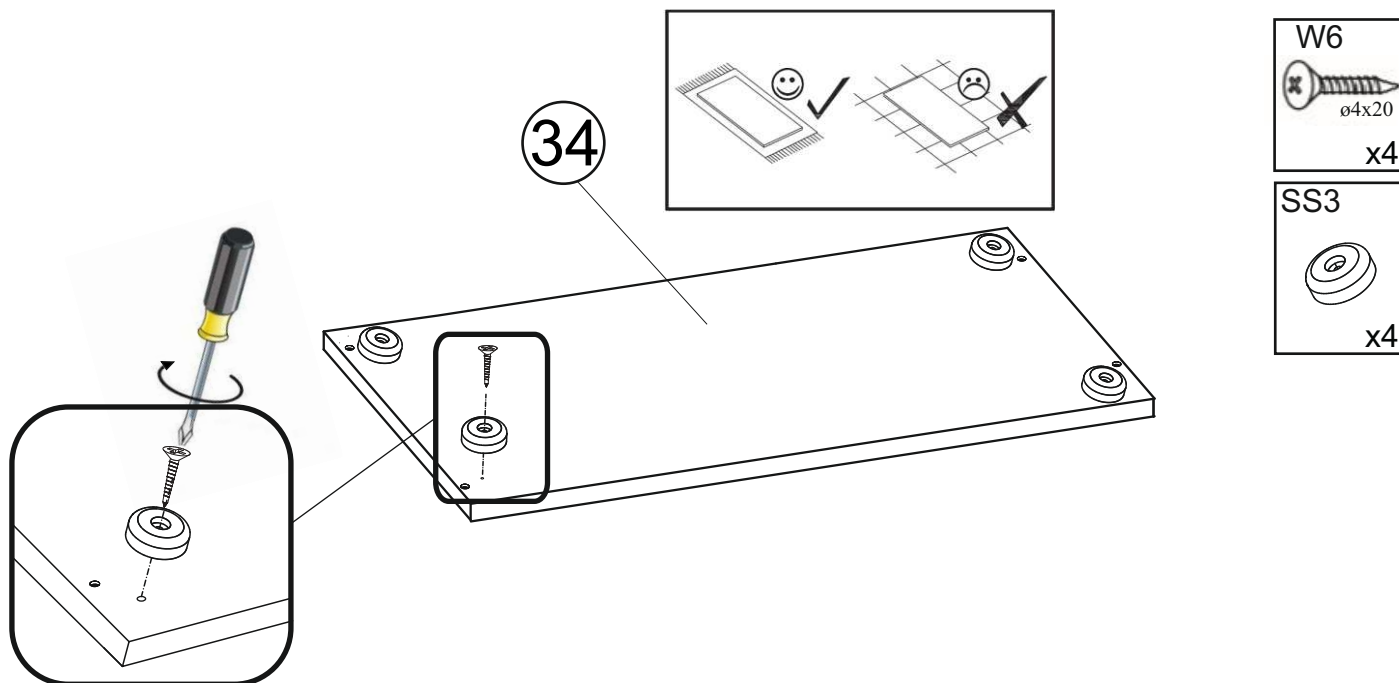

45

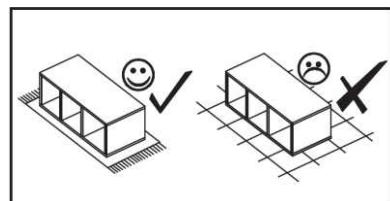
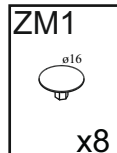
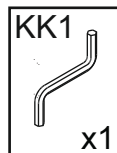
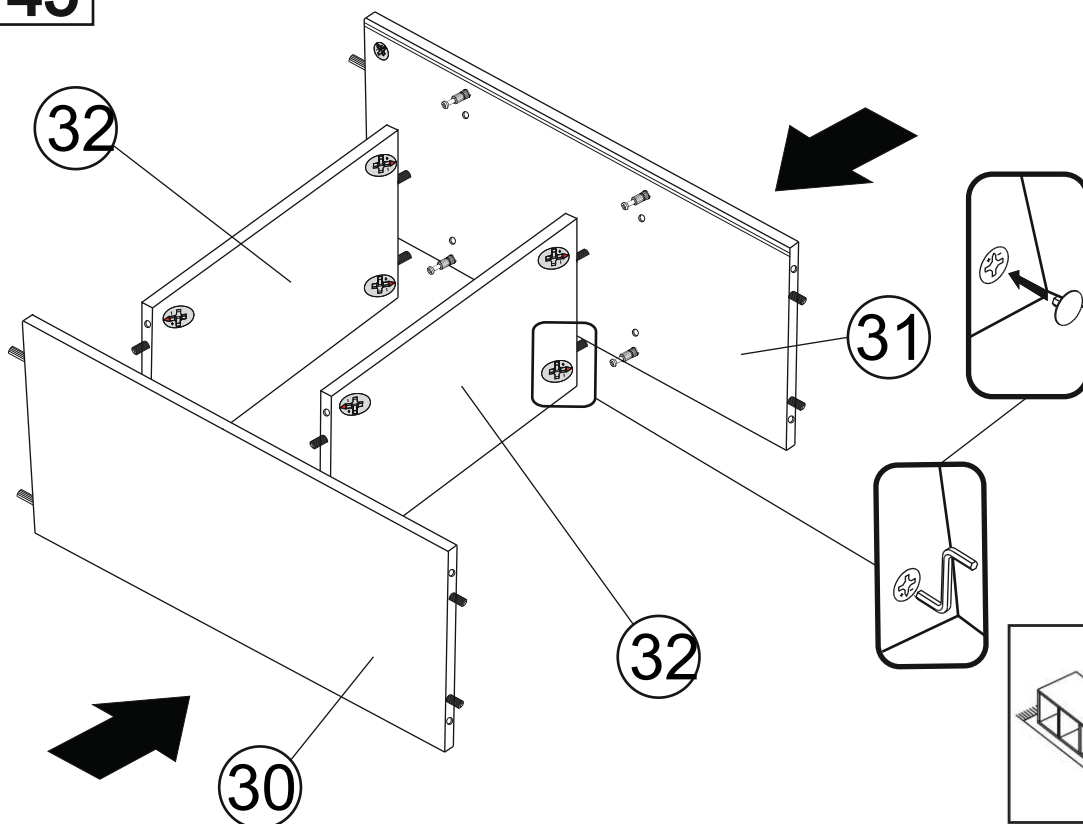

46

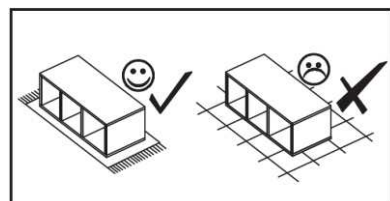
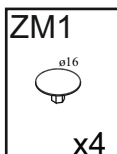
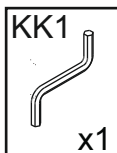
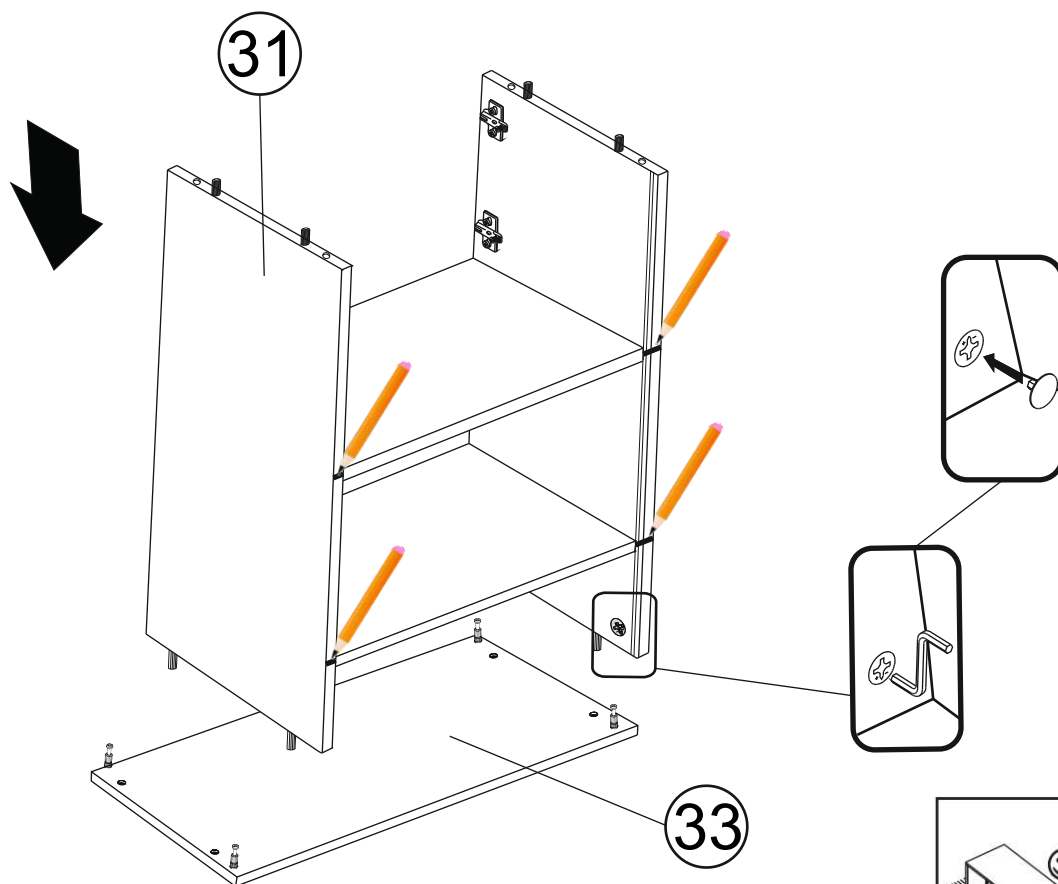

47

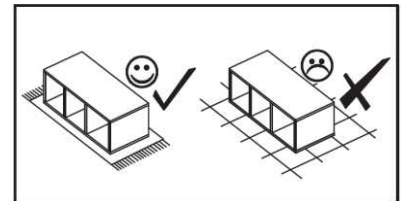
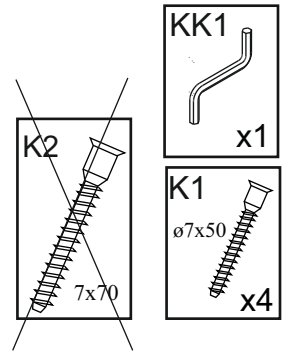
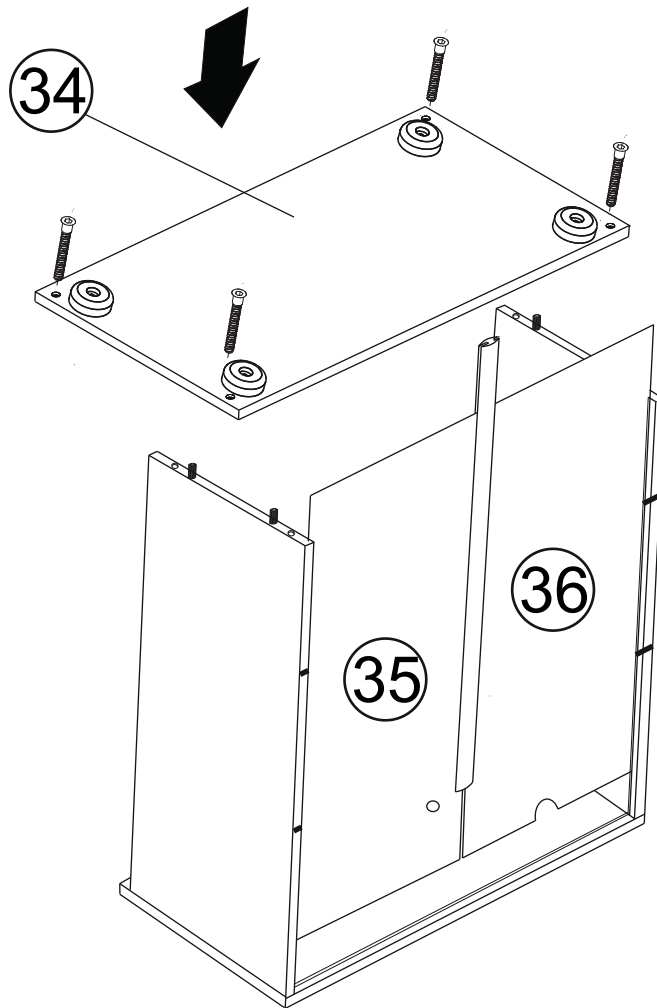

48

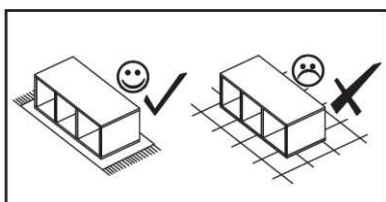
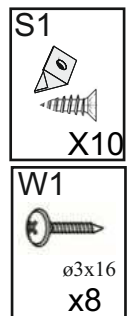
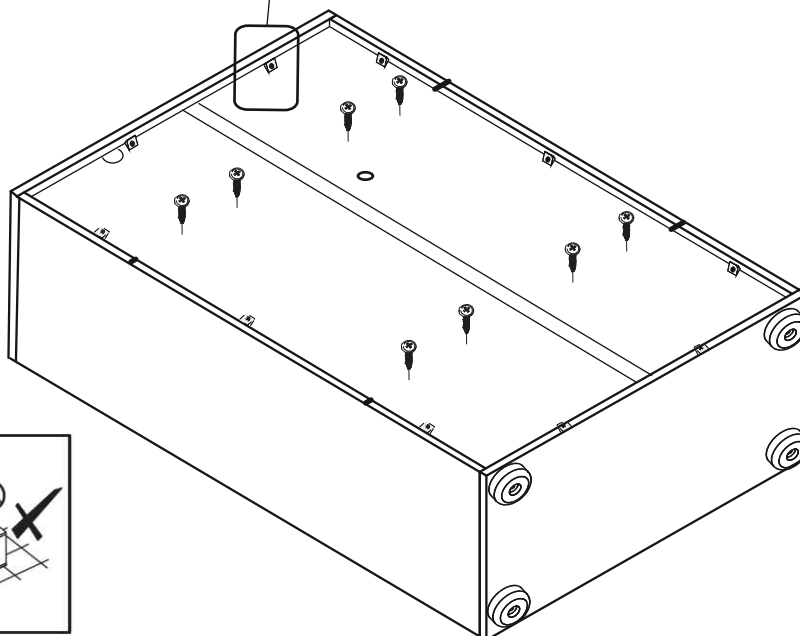
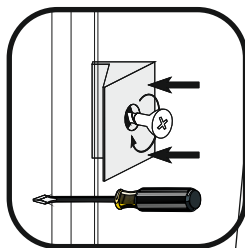
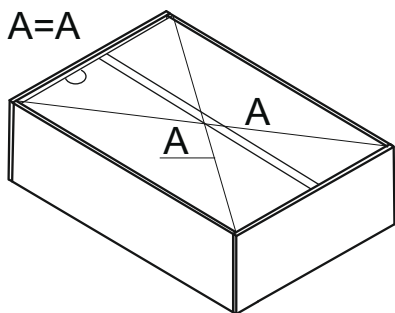

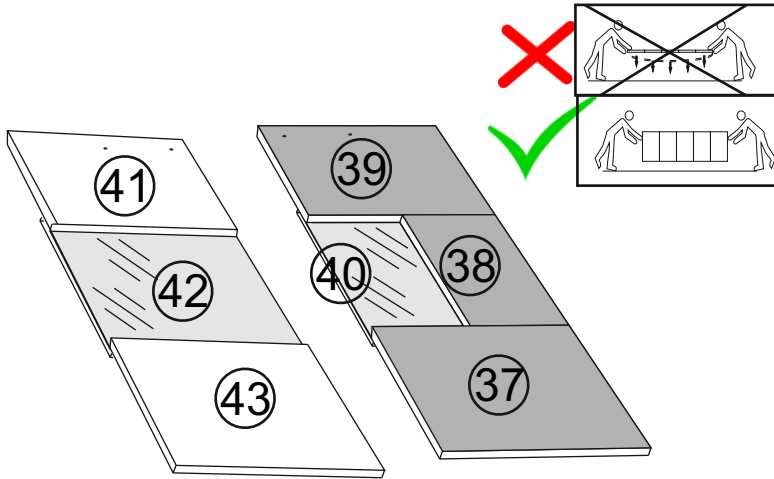

49

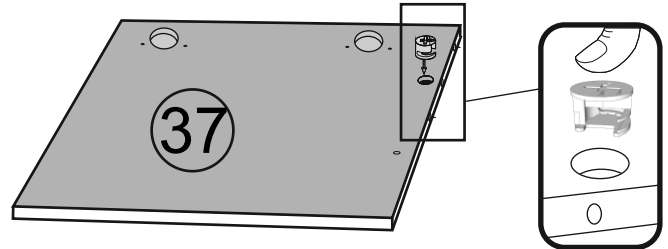
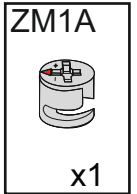
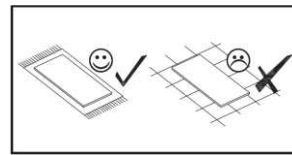

50

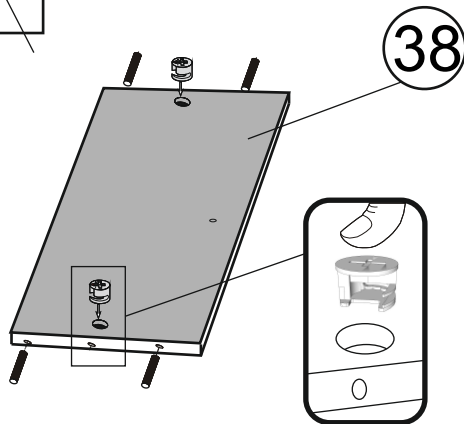
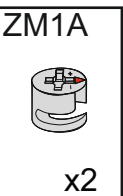
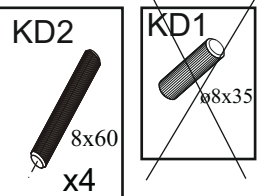
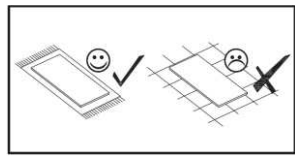

51

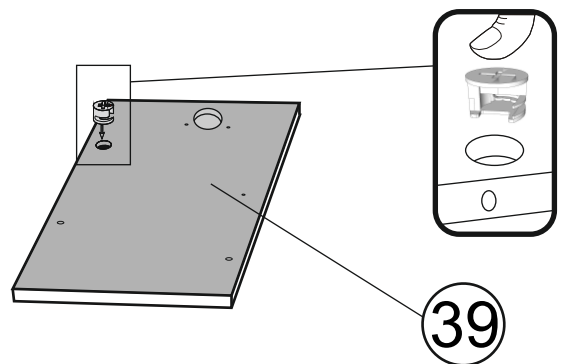
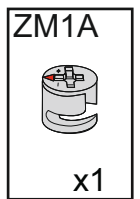
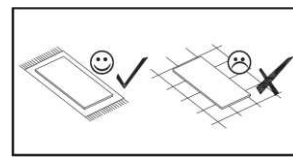

52

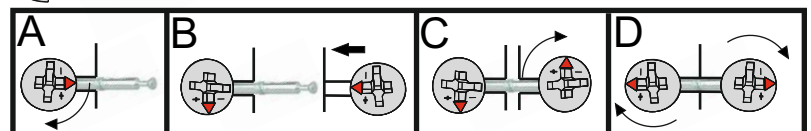
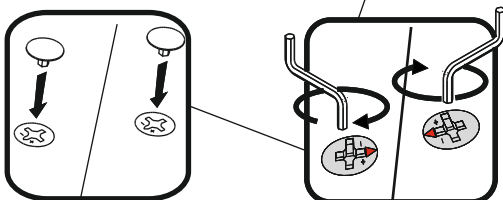
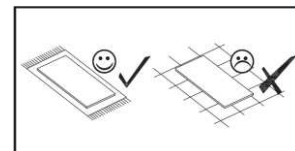
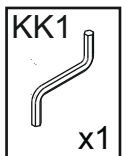
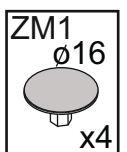
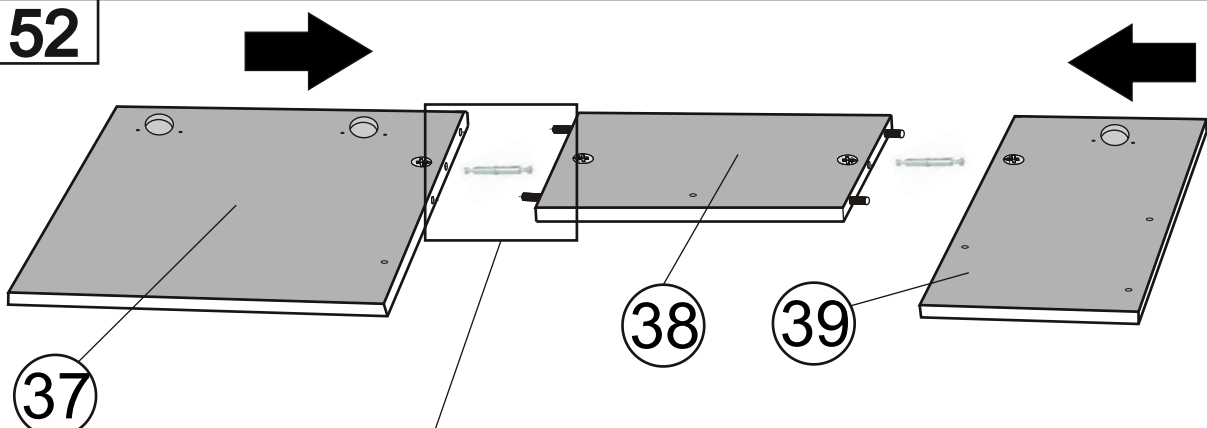

53

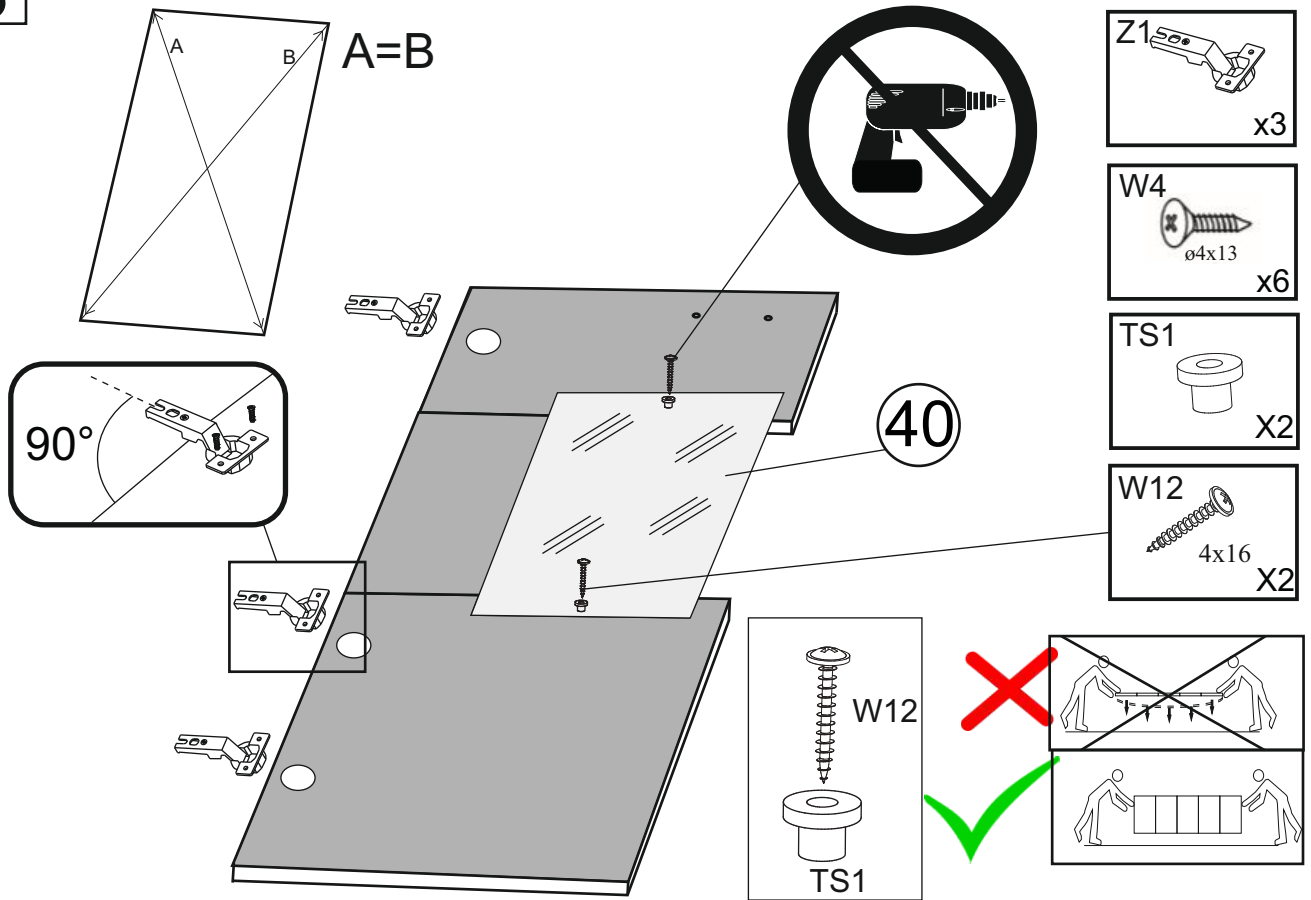

54

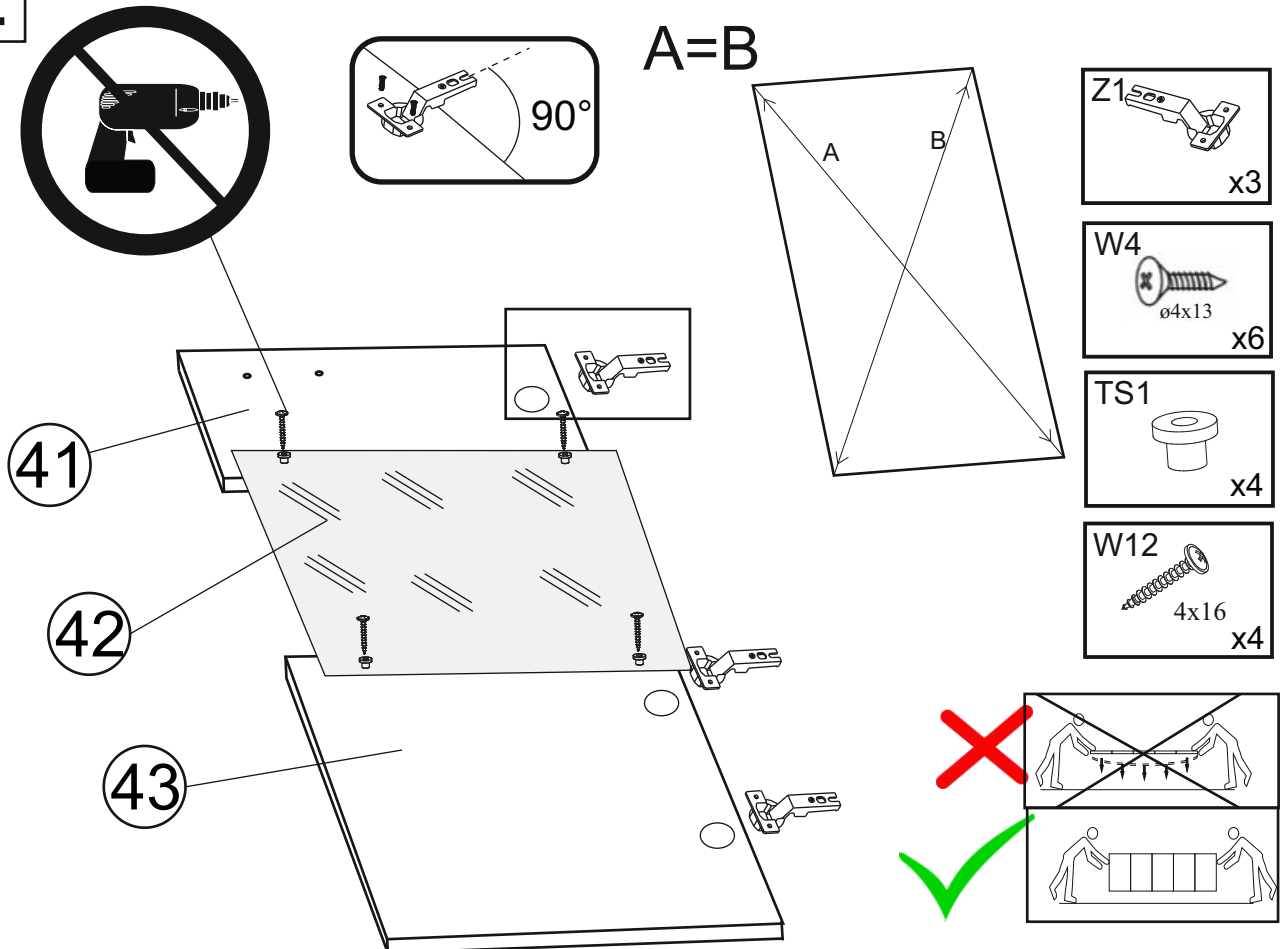

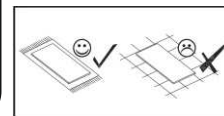
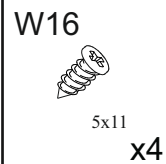
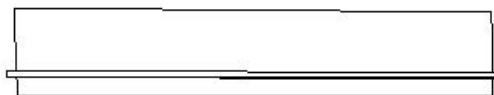
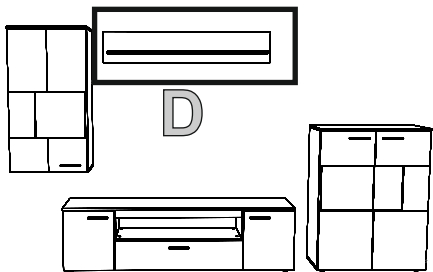

55

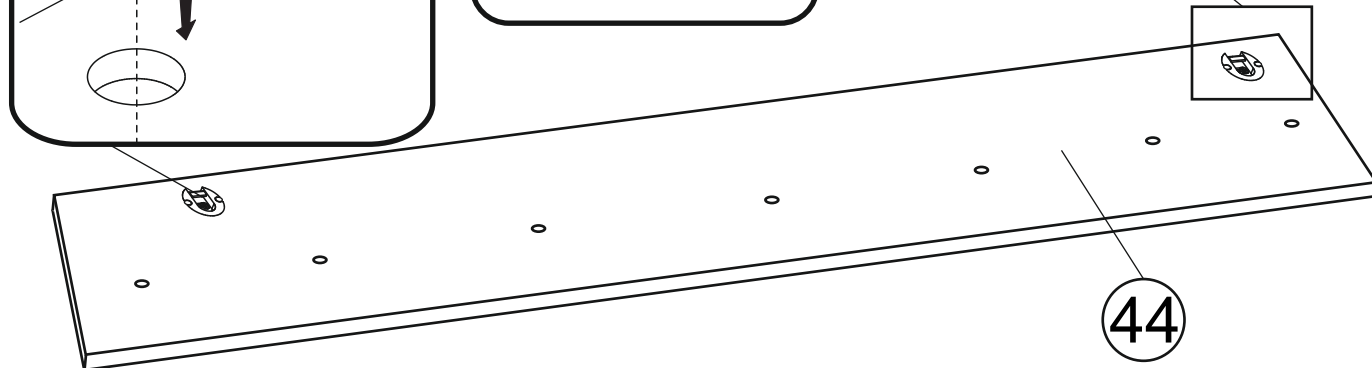
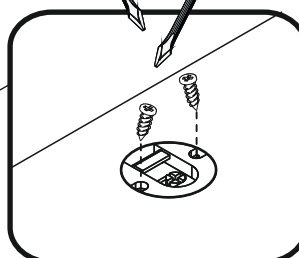
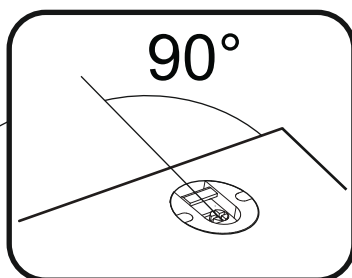
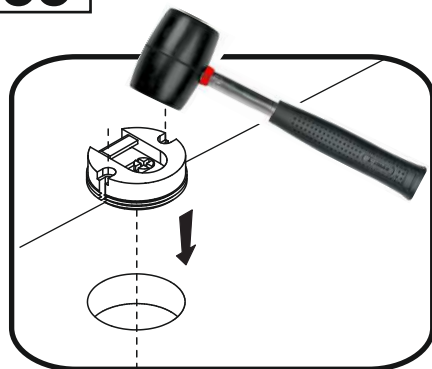

44

56

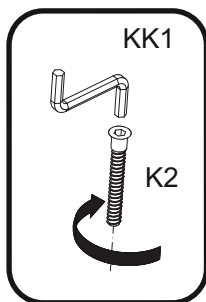

44

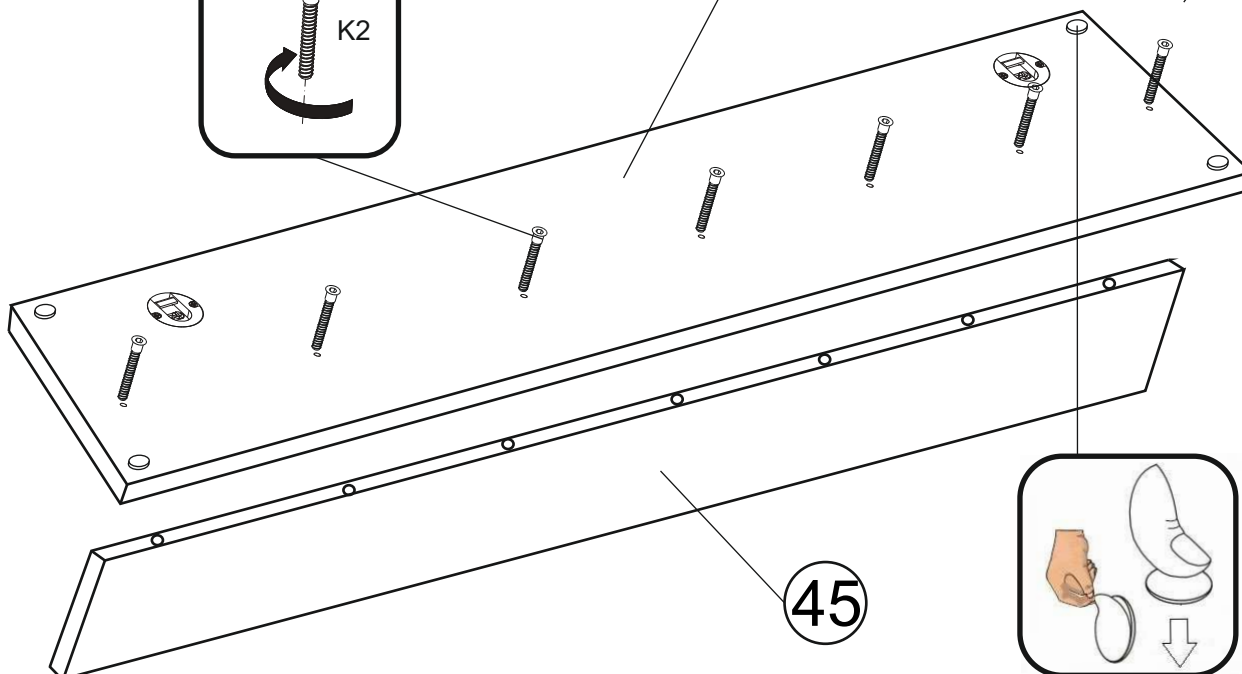
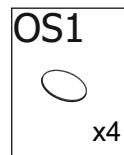
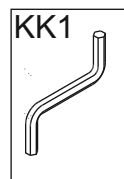
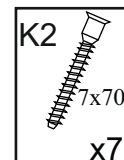
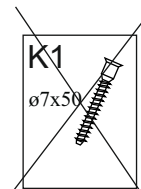

45

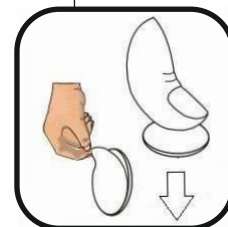

57

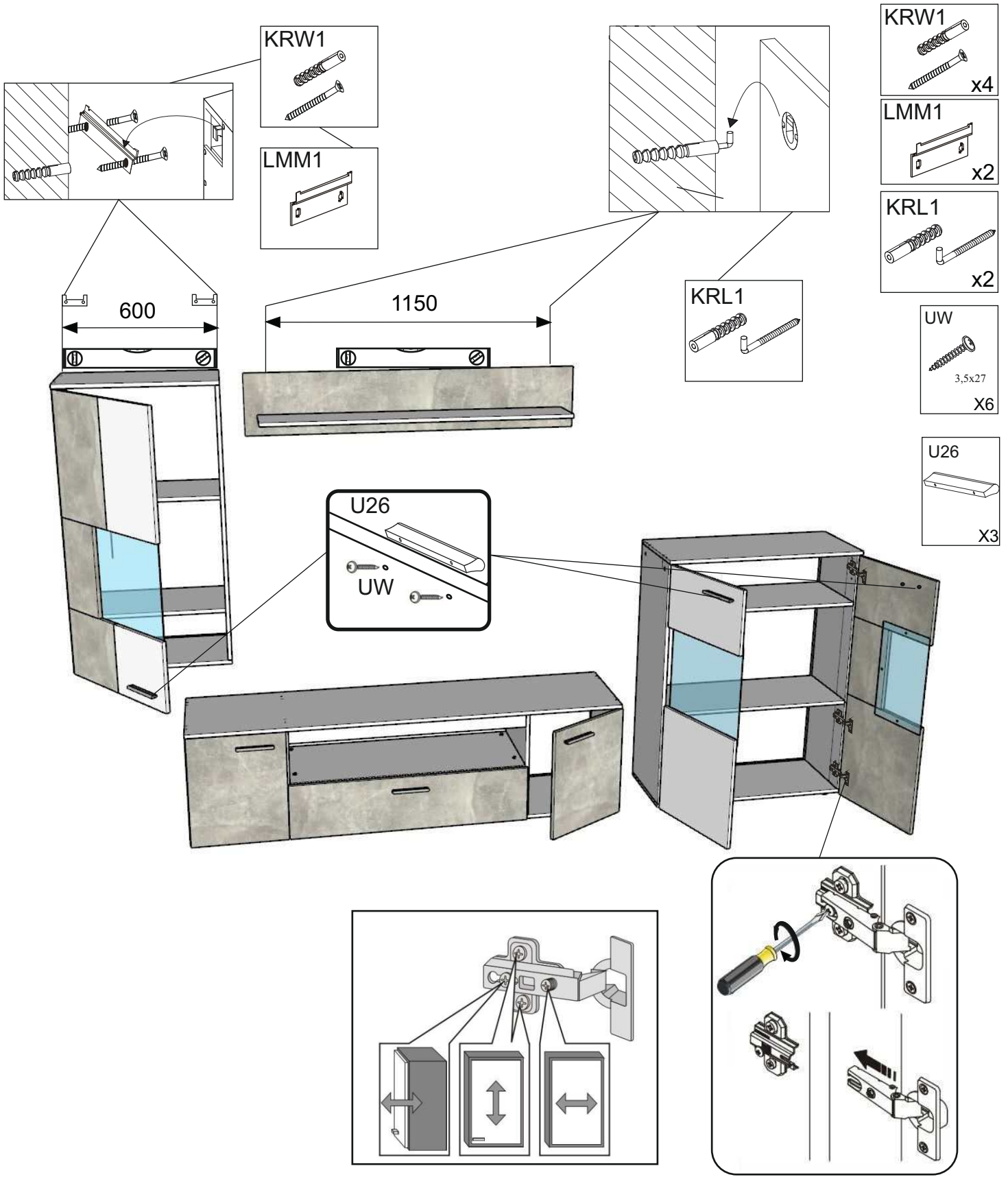

58

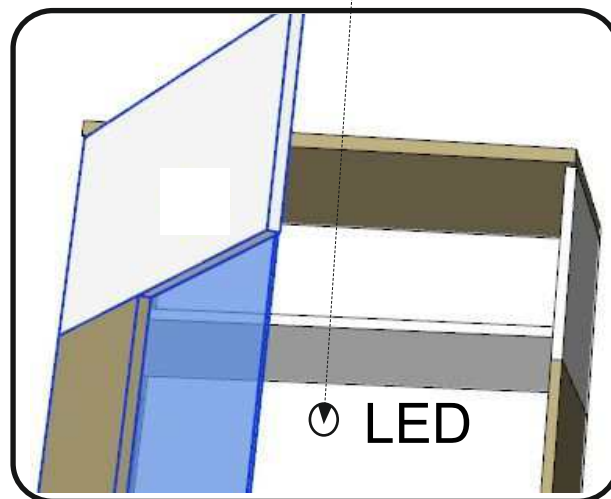
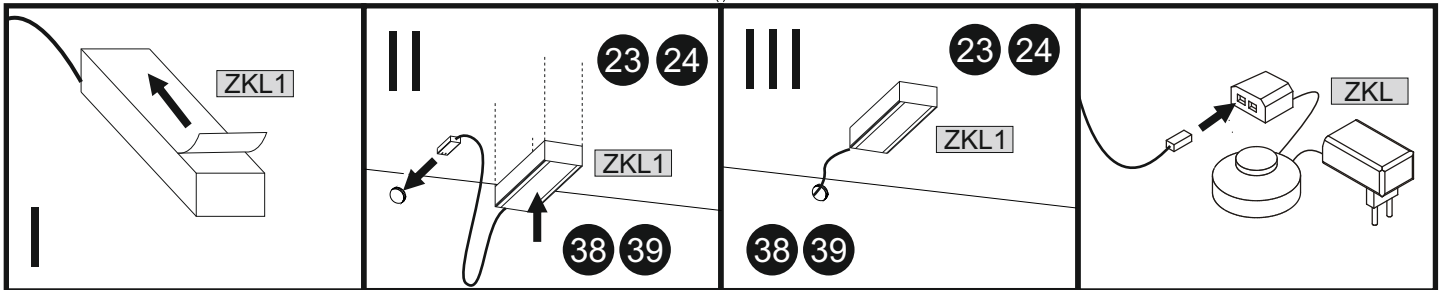
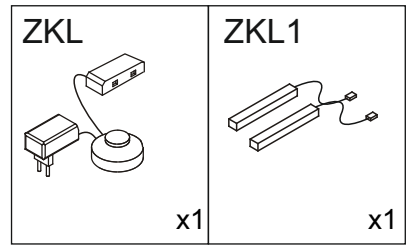
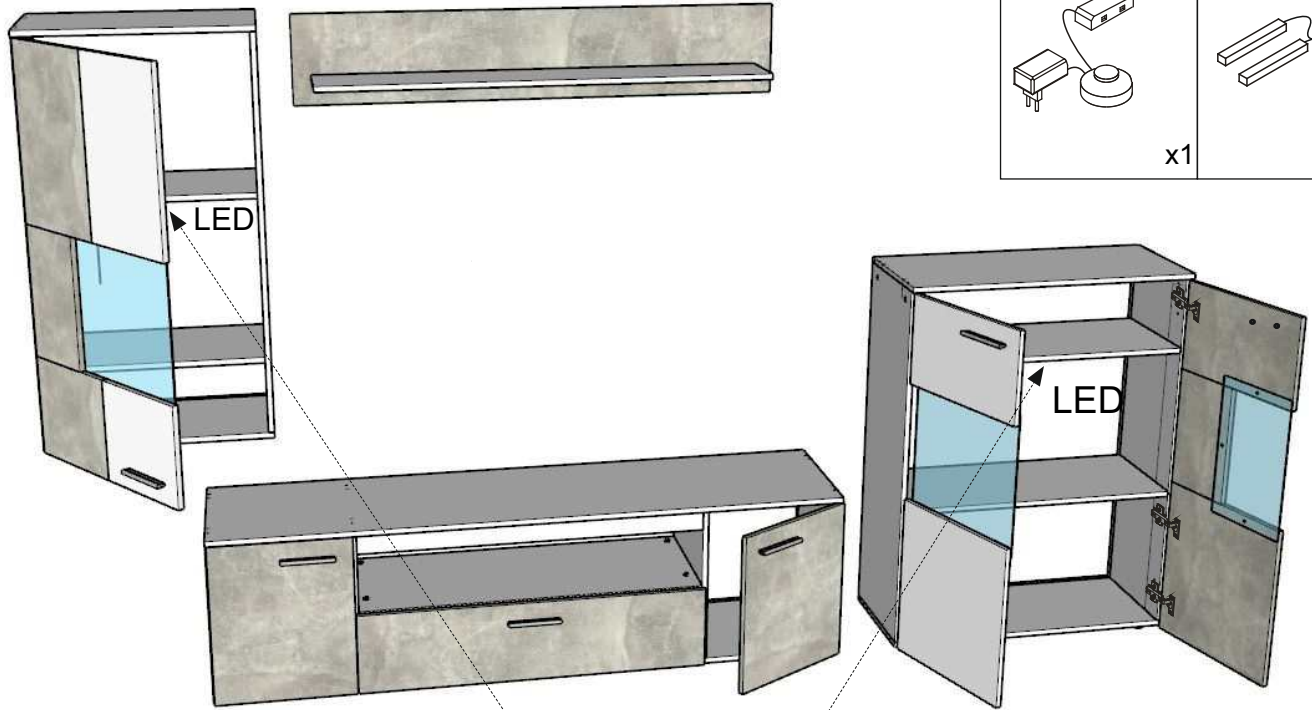

59

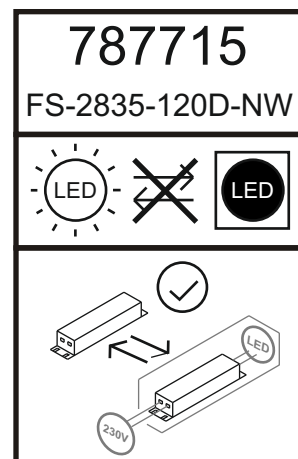
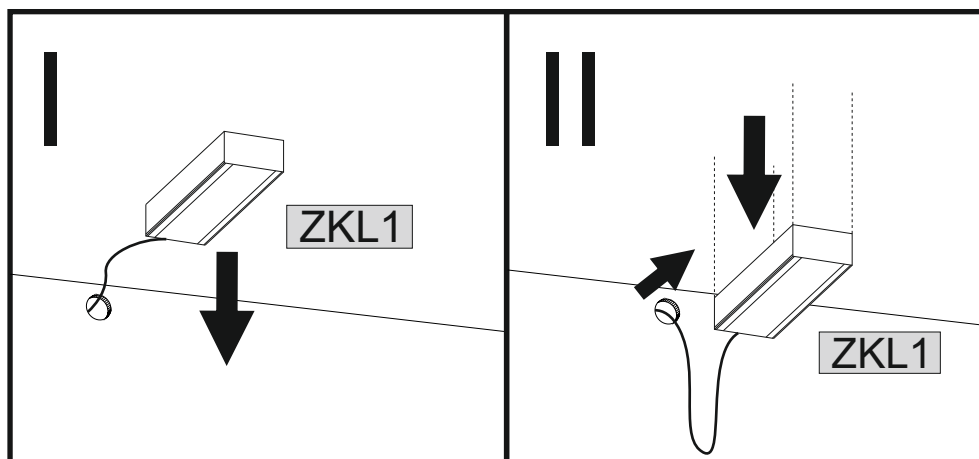
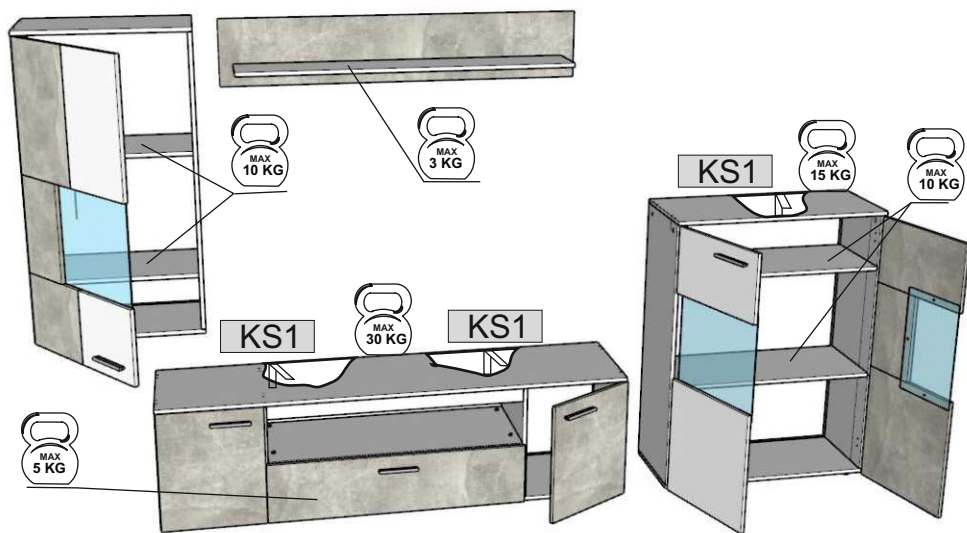
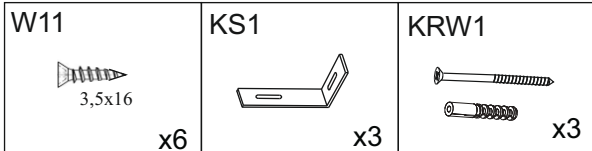

PL- Ten produkt zawiera źródła światła o klasie efektywności energetycznej „E”	DE- Diese Produkte enthalten Lichtquellen der Energieeffizienzklasse „E”	CS- Tento výrobek obsahuje světelný zdroj třídy energetické účinnosti „E”
DA- Dette produkt indeholder en lyskilde til energieffektivitetsklasse „E”	EL- Αυτό το προϊόν περιέχει μια πηγή φωτεινής πηγής ενεργειακής απόδοσης „E”	EN- This product contains a light sources of energy efficiency class „E”
ES- Este producto contiene una fuente de luz de clase de eficiencia energética „E”	ET- See toode sisaldab efektiivsusklassi valgusallikat energia „E”	FI- Tämä tuote sisältää energiatehokkuusluokan valonlähteen „E”
FR- Ce produit contient des sources lumineuses de classe d'efficacité „E”	HU- Ez a termék energiahatékonysági osztályú fényforrást tartalmaz „E”	IT- Questo prodotto contiene una sorgente luminosa di classe di efficienza energetica „E”
LT- Šiame gaminyje yra energijos vartojimo efektyvumo klasės šviesos šaltinis „E”	LV- Šis produkts satur gaismas avotu ar energoefektivitātes klasi „E”	RU- Этот продукт содержит источник света класса энергоэффективности „E”
PT- Este produto contém uma fonte de luz da classe de eficiência energética „E”	RO- Acest produs conține o sursă de lumină de clasă de eficiență energetică „E”	NL- Dit product bevat een lichtbron met energie-efficiëntieklasse „E”
SK- Tento výrobok obsahuje svetelný zdroj triedy energetickej účinnosti „E”	SLO- Ta izdelek vsebuje svetlobni vir razreda energijske učinkovitosti „E”	SV- Denna produkt innehåller en ljuskälla för energieffektivitetsklass „E”
TR- Bu ürün bir ışık kaynağı enerji verimliliği sınıfı içerir „E”	HR- Ovaj proizvod sadrži izvor svjetlosti razreda energetske učinkovitosti „E”	BG- Този продукт съдържа източник на светлина от клас на енергийна ефективност „E”