

# Leandra

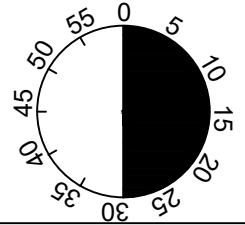

1

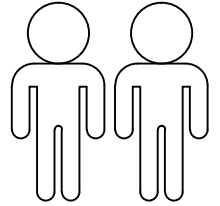
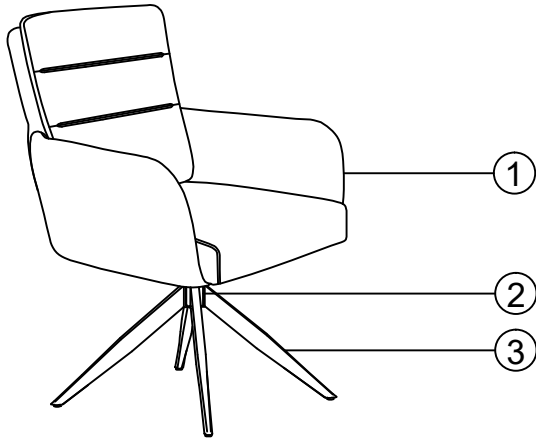
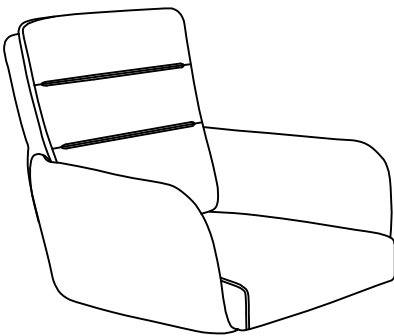

2

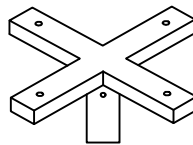

KP 120x120x85mm AR

3

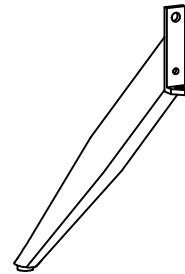

4

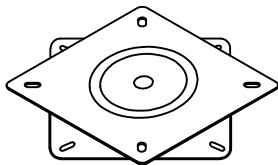





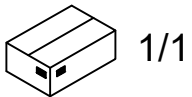

DT 180° AR 195X195mm

1	1x
2	1x
3	4x
4	1x

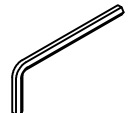
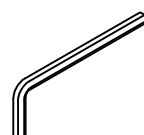

1/1

<b>A</b>	M6X13	<b>B</b>	M6X20	<b>C</b>	M8X16	<b>D</b>	M6	<b>E</b>	Ø18xØ6x1.5	<b>F</b>	4MM
											
4x		8x		4x		4x		12x		1x	
<b>G</b>	5MM	<b>H</b>	Ø17xØ6.5x4								
											
1x		2x									

I.

1

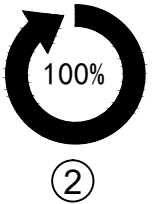
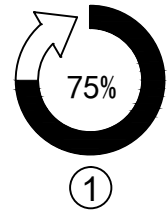
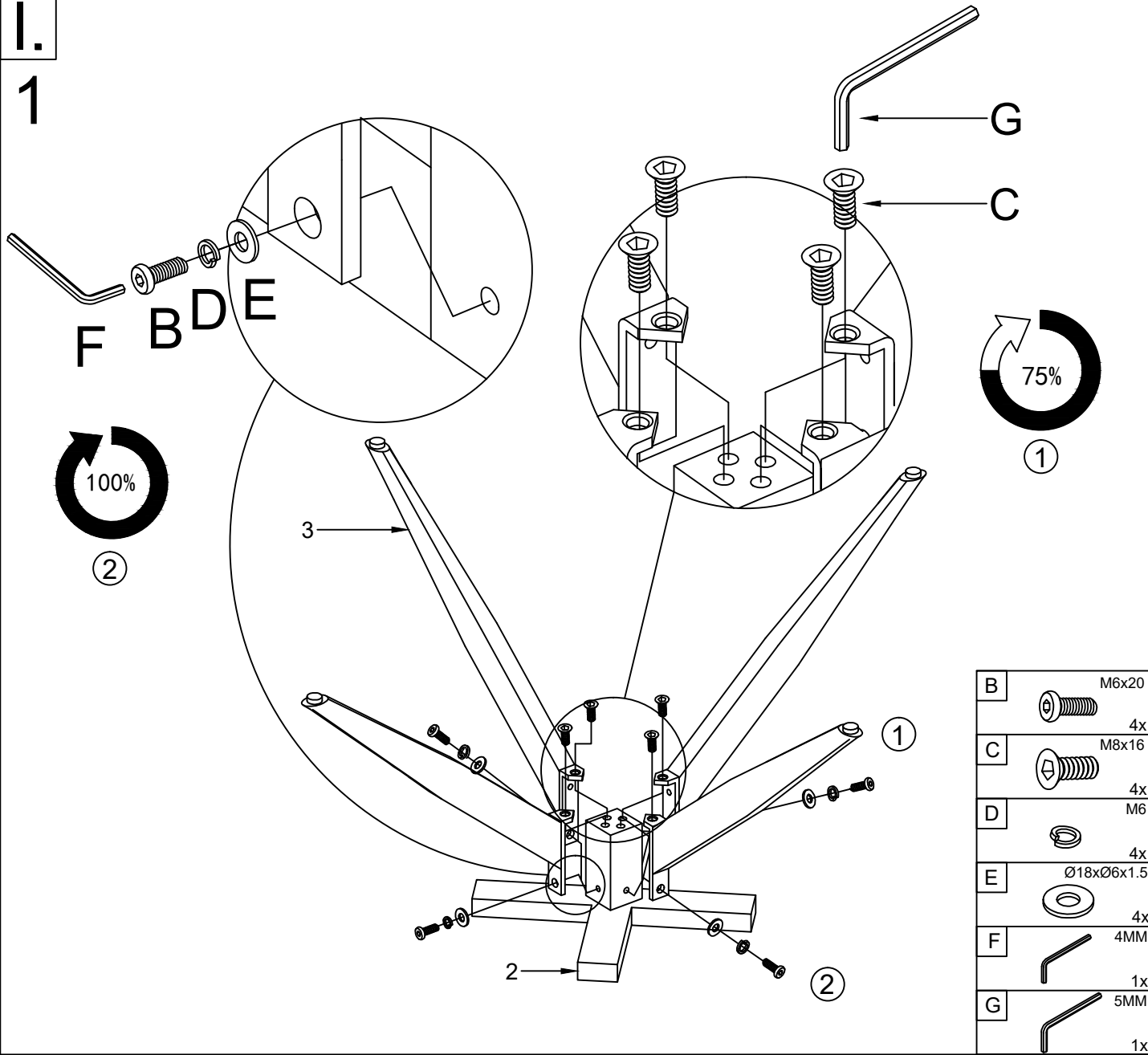

B	M6x20
	4x
C	M8x16
	4x
D	M6
	4x
E	Ø18xØ6x1.5
	4x
F	4MM
	1x
G	5MM
	1x

2

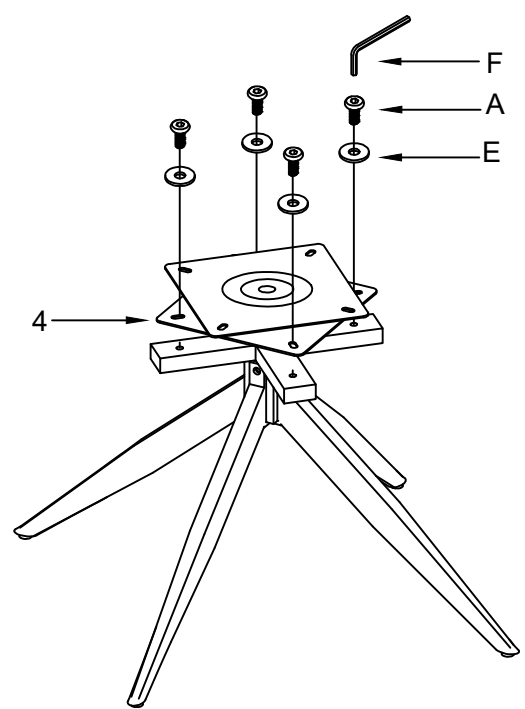

A	M6x13
	4x
E	Ø18xØ6x1.5
	4x
F	4MM
	1x
	100%

II.

3

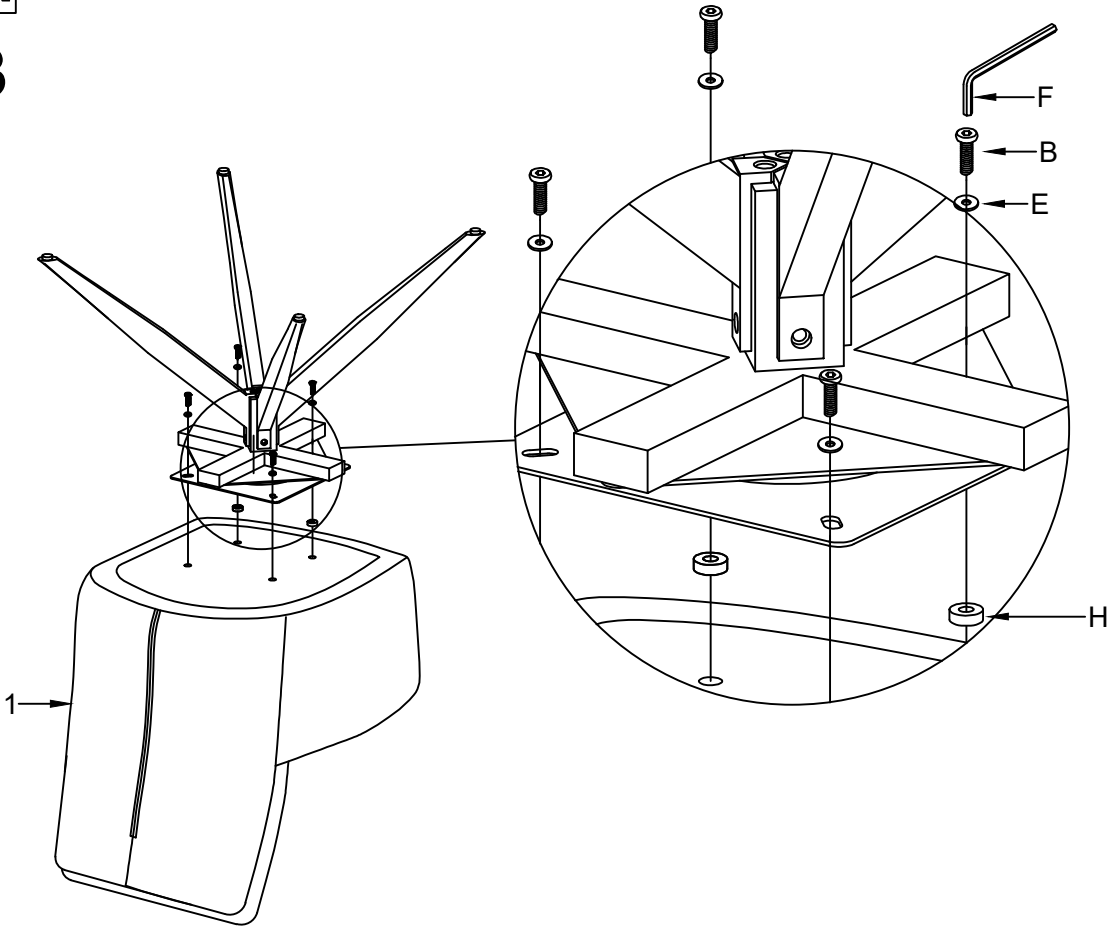

B	M6X20
	4x
E	Ø18xØ6x1.5
	4x
F	4MM
	1x
H	Ø17xØ6.5x4
	2x

4



F	4MM
	1x
G	5MM
	1x



LE TRI  
+ FACILE



Séparez les éléments avant de trier