

- |   |                                     |
|---|-------------------------------------|
| <b>(D)</b> Montageanleitung             | <b>(GB)</b> Assembly instructions   |
| <b>(FR)</b> Notice de montage           | <b>(IT)</b> Istruzioni di montaggio |
| <b>(NL)</b> Handleiding voor de montage | <b>(PL)</b> Instrukcja montażu      |
| <b>(CZ)</b> Montážní návod              | <b>(SK)</b> Návod na montáž         |
| <b>(HU)</b> Szerelési útmutató          | <b>(RO)</b> Instrucțiuni de montare |
| <b>(TR)</b> Montaj talimati             | <b>(RU)</b> инструкции по монтажу   |

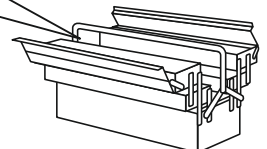

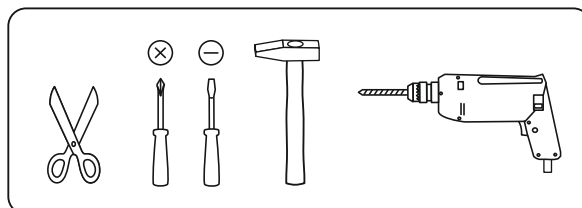
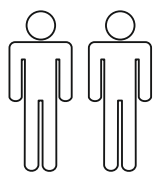
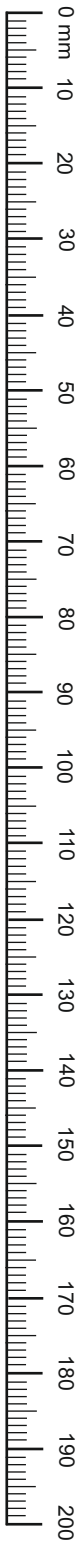

# Service - Assistenza - Dienstverlening - Serwis Servis Szerviz - Servicii - статистическая служба

|   |  |  |
|---|--|--|
| Name • Nom • Nome • Naam<br>Nazwa • Jméno • Názov • Név<br>Denumire • Isim • название |  |  |
| Nr. • No. • N° • номеро • Č • Sz  |  |  |
| Тур • Type • Tip • Típus • Tipo • тип   |  |  |
|   |  |  |

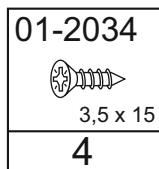
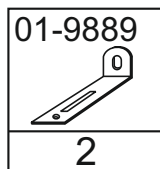
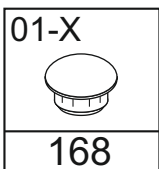
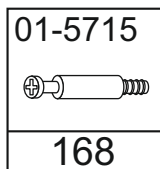
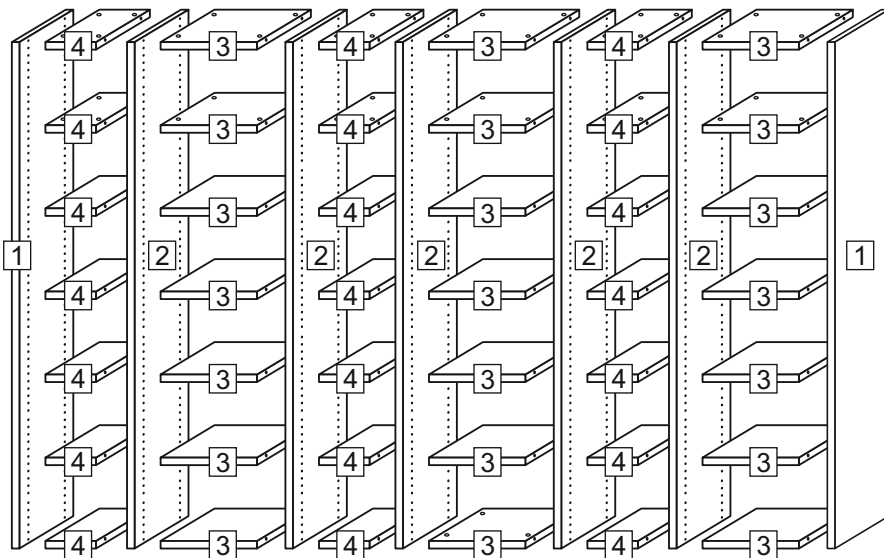
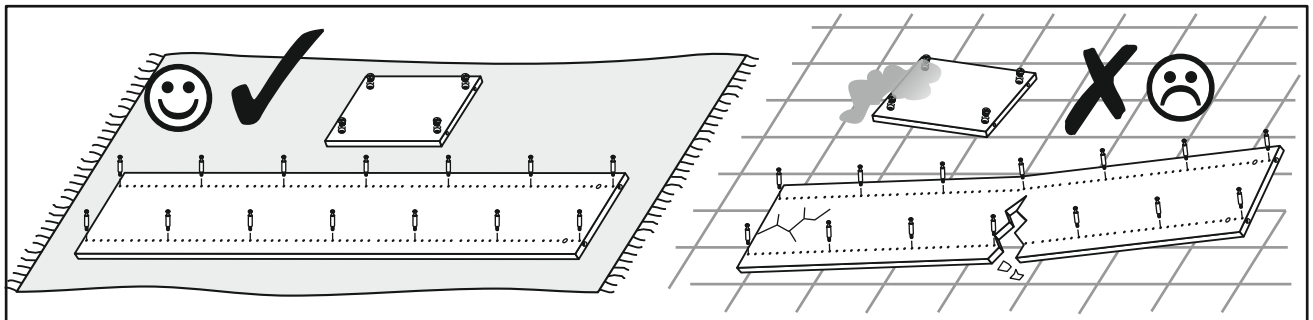

|  |   |
|--|---|
| <b>D</b> Bitte nur mit einem Staubtuch oder leicht feuchtem Lappen reinigen. Keine scheuernden Putzmittel verwenden.                                 | <b>CZ</b> Čistěte prosím jen prachovkou nebo lehce navlhčeným hadrem. Nepoužívejte drhnutí čistící prostředky.                                      |
| <b>GB</b> Please only clean with a duster or a damp cloth. Do not use any abrasive cleaners.   | <b>SK</b> Na čistenie používajte len prachovku alebo zľahka navlhčenú utierku. Nepoužívajte žiadne drhúce čistiace prostriedky.                     |
| <b>FR</b> Veuillez nettoyer uniquement avec un chiffon à poussière ou un chiffon légèrement humide. Ne pas utiliser de détergent abrasif.            | <b>HU</b> Kérjük, csak portörő kendővel vagy enyhén nedves ronggyal tisztítsa. Ne használjon dörzshatású tisztítószeret.                            |
| <b>IT</b> Si raccomanda di pulire solo con un panno per la polvere o uno strofinaccio umido. Non utilizzare detergenti abrasivi.                     | <b>RO</b> Vă rugăm să utilizați la curățare exclusiv o cârpă de șters prafuri sau o cârpă ușor umezită. Nu utilizați substanțe de curățat abrazive. |
| <b>NL</b> Reinig alleen met een stofdoek of een lichtjes vochtige doek. Gebruik geen schurende poetsmiddelen.  | <b>TR</b> Lütfen sadece bir toz bezikle veya hafif nemli yumuşak bir bezle siliniz. Aşındırıcı temizlik malzemeleri kullanmayınız.                  |
| <b>PL</b> Czyszczenie należy wykonać wyłącznie za pomocą ściereczki lub lekko nawilżonego ręcznika. Nie stosować środków czyszczących do szorowania. | <b>RU</b> Очищайте от пыли тряпкой или слегка влажной ветошью. Не допускается применение чистящих средств, не предназначенных для ухода за мебелью. |

