

Art. Nr. 46-076-17

«VENEDIG»

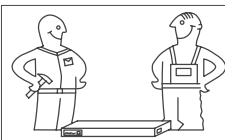

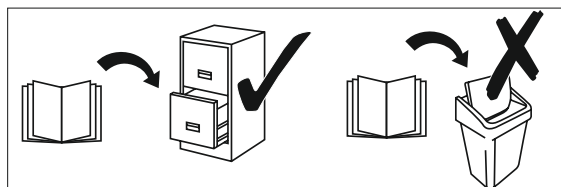

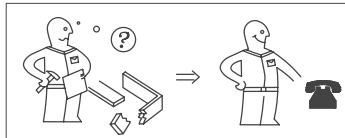
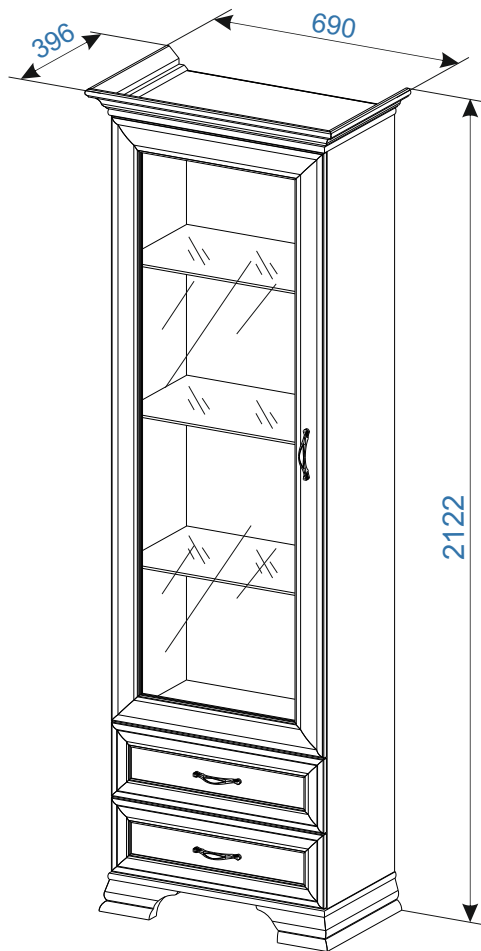
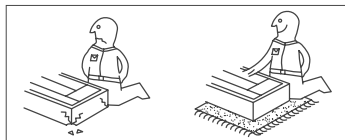



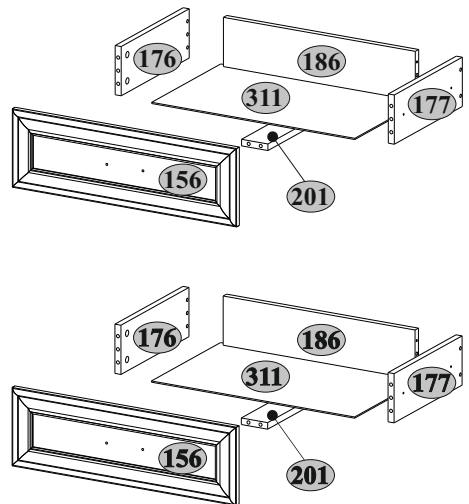
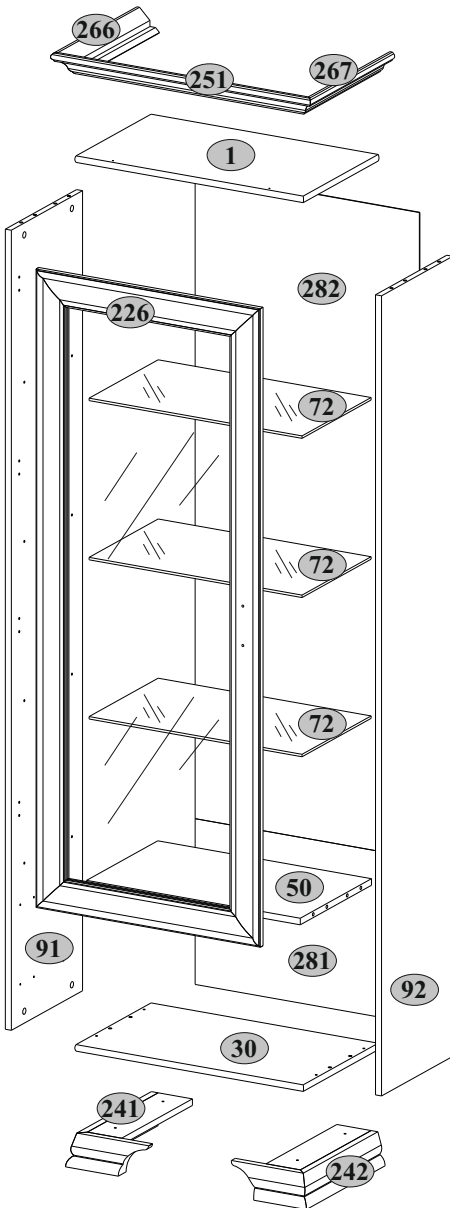

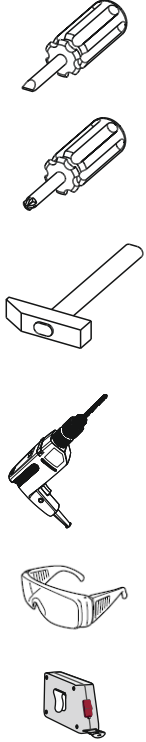





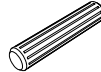

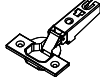

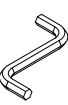





2 Pers.

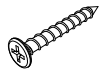
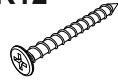

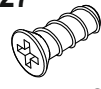
| № | L | B | S | Number | Colie |
|-----|------|-----|-----|--------|-------|
| 1 | 608 | 355 | 16 | 1 | 3/3 |
| 30 | 608 | 355 | 16 | 1 | 3/3 |
| 50 | 568 | 335 | 16 | 1 | 3/3 |
| 72 | 564 | 325 | 6 | 3 | 3/3 |
| 91 | 1950 | 335 | 16 | 1 | 1/3 |
| 92 | 1950 | 335 | 16 | 1 | 1/3 |
| 156 | 596 | 191 | 19 | 2 | 1/3 |
| 176 | 320 | 120 | 16 | 2 | 1/3 |
| 177 | 320 | 120 | 16 | 2 | 1/3 |
| 186 | 510 | 120 | 16 | 2 | 3/3 |
| 201 | 320 | 70 | 16 | 2 | 1/3 |
| 226 | 1556 | 596 | 19 | 1 | 3/3 |
| 241 | 210 | 370 | 80 | 1 | 2/3 |
| 242 | 210 | 370 | 80 | 1 | 2/3 |
| 251 | 690 | 80 | 19 | 1 | 1/3 |
| 266 | 396 | 80 | 19 | 1 | 1/3 |
| 267 | 396 | 80 | 19 | 1 | 1/3 |
| 281 | 596 | 404 | 2,5 | 1 | 3/3 |
| 282 | 1574 | 596 | 2,5 | 1 | 3/3 |
| 311 | 540 | 325 | 2,5 | 2 | 3/3 |

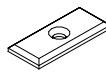

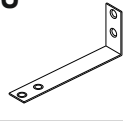
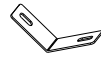

| | | | |
|--|--|---|---|
| A1  22 | A2  22 | B5  10x50 1 | C1  8x35 22 |
| D1  4 | E1  4 | G  1,5x26 62 | H18  3 |
| I  1 | M1  M4x12 4 | M12  M4x25 2 | N1  6 |
| P4  12 | Q  6 | R3  3x20 22 | Rt4  3,5x25 6 |
| R10  4x30 4 | R12  4x40 4 | R23  6,3x13 8 | R24  7x50 8 |
| R27  5,0x13 20 | R30  2,9x9,5 4 | R102  3,5x16 10 | S3  2 |
| S5  12 | S11  8 | U  1 | U8  120° 2 |
| Z10  300 2 | | | |

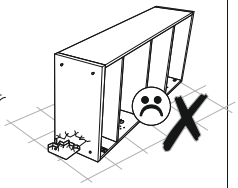
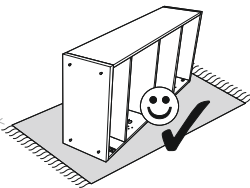
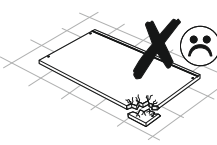
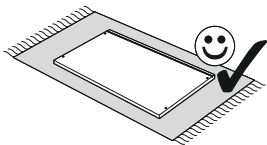
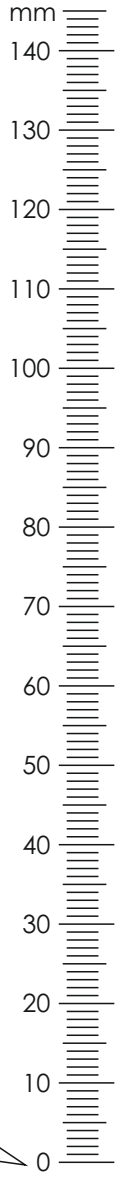

1

A1



2 8x35

C1

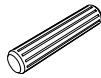

4

P4



6

R27



5,0x13

6

S11



8

Z10

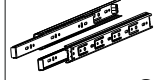





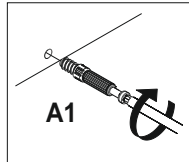
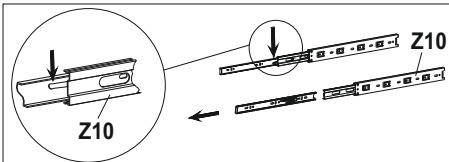
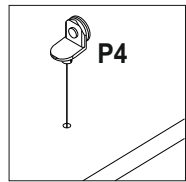
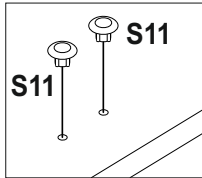
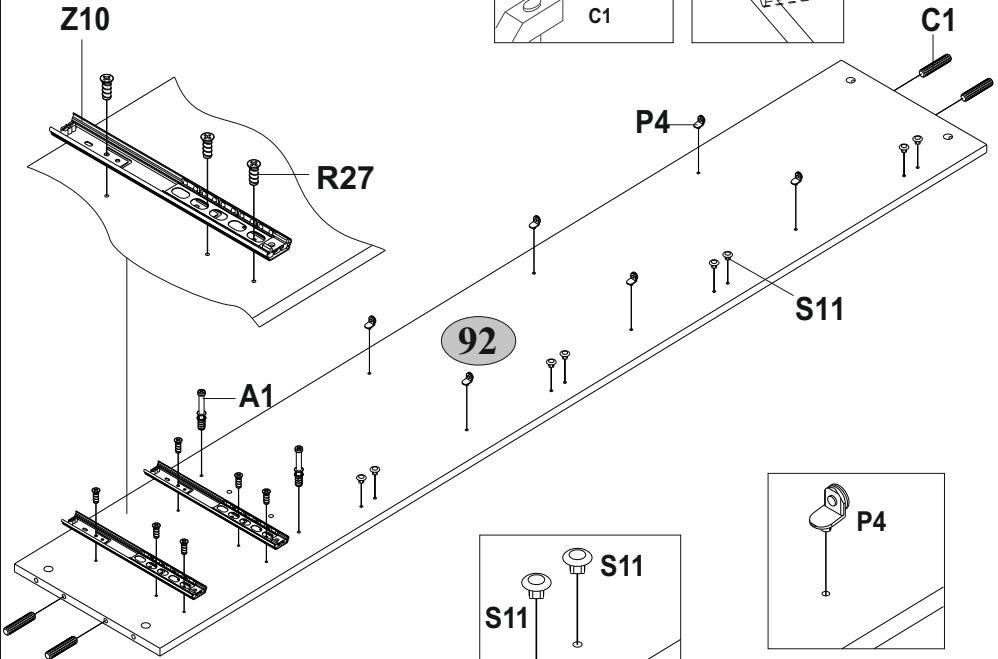
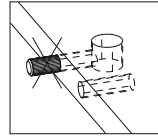
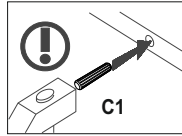
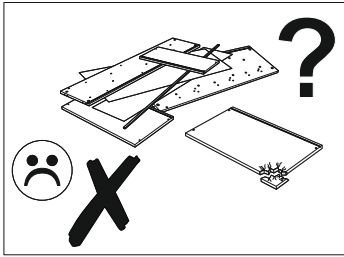

300

2

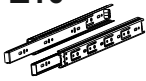

2

| | | | | | |
|---|--|---|---|---|---|
| A1  2 | C1  8x35 | D1  4 | P4  6 | R23  6,3x13 | 8 |
| R27  5,0x13 | Z10  300 | 6 | 2 | | |

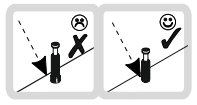
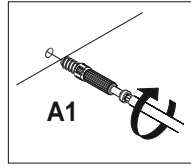
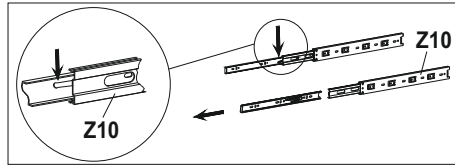
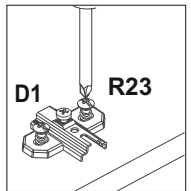
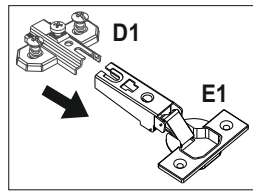
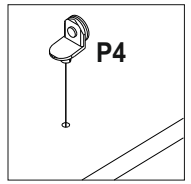
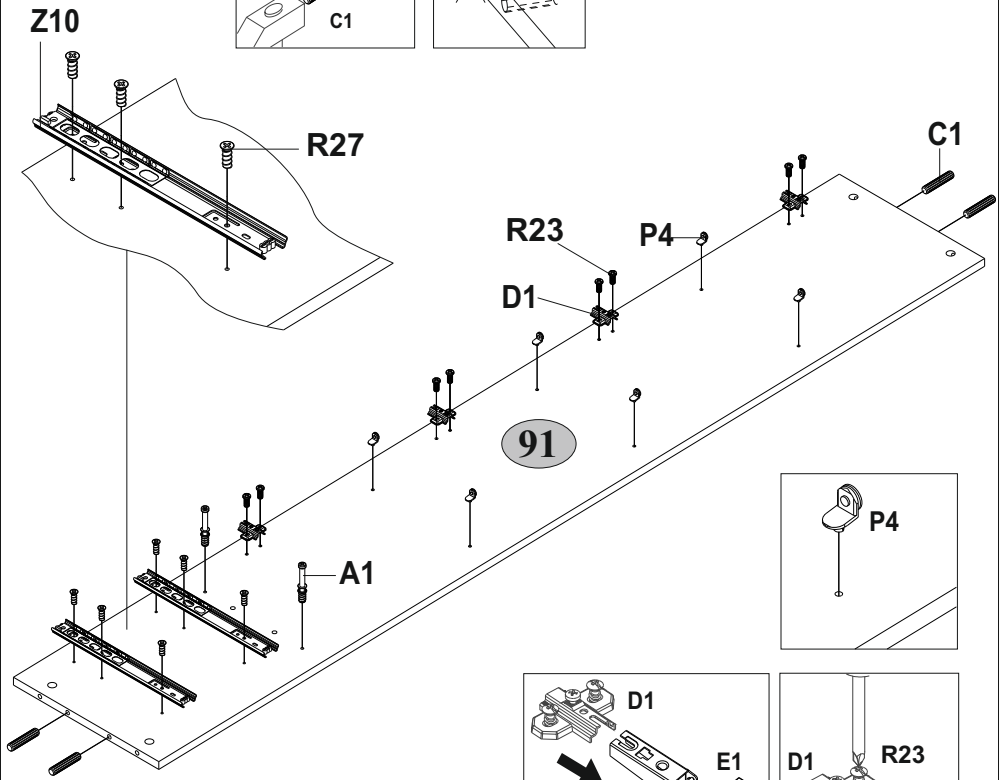
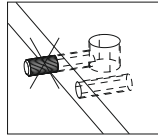
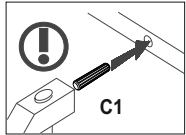

3

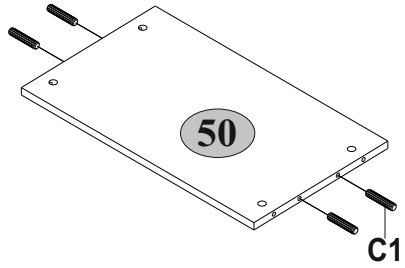
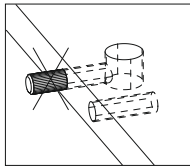
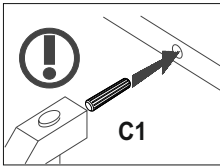
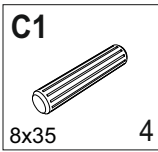

4

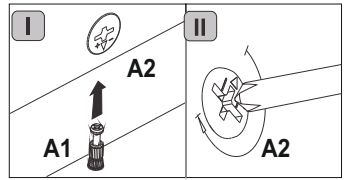
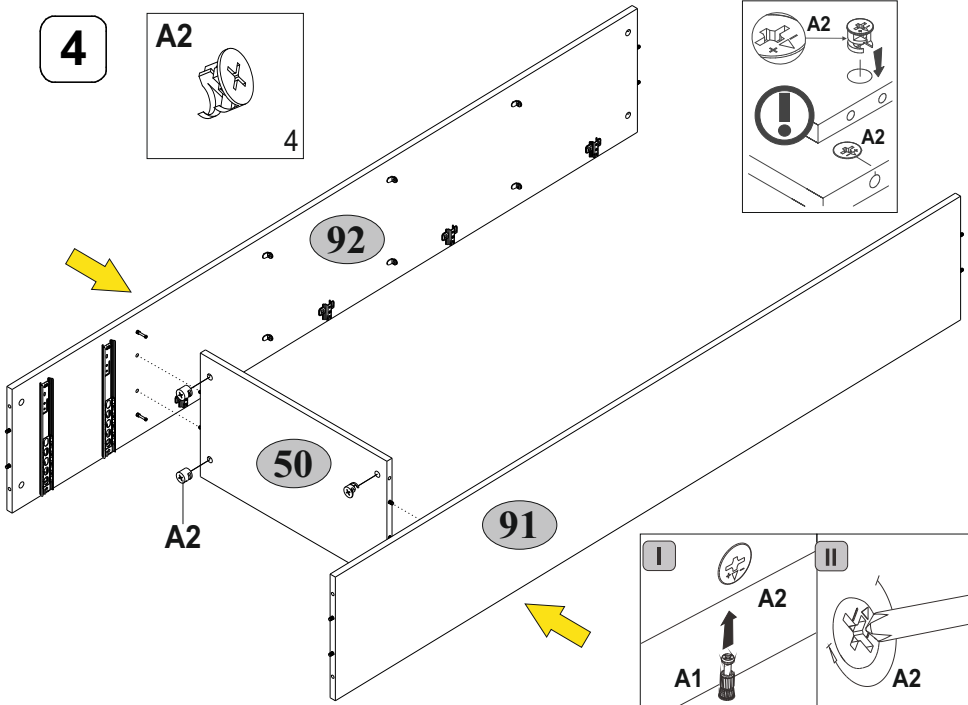
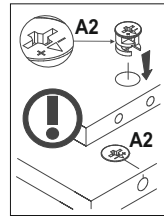
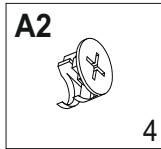

5

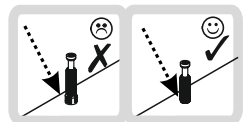
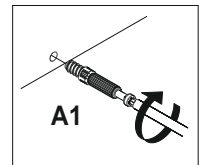
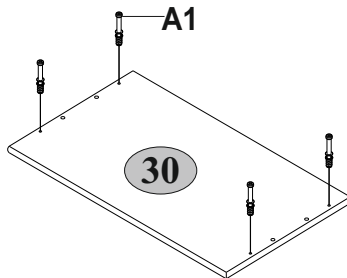
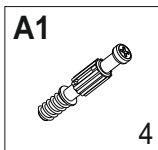

6

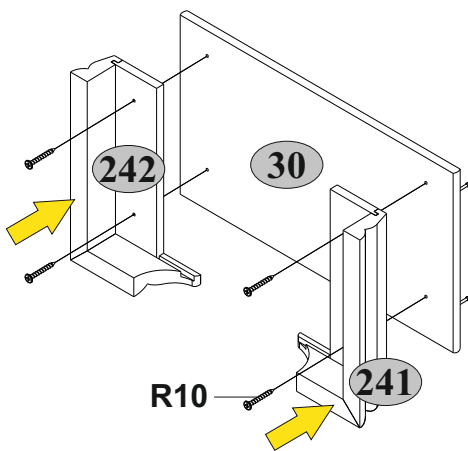
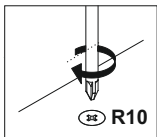
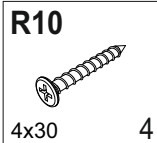

7

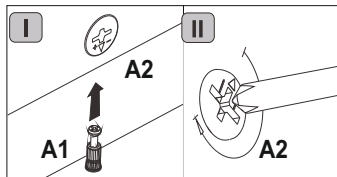
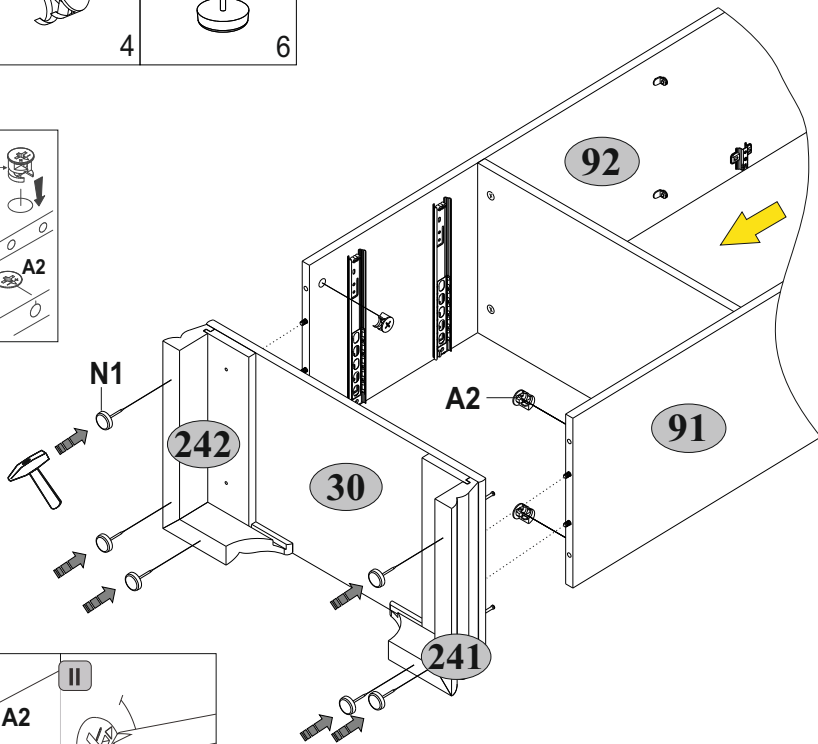
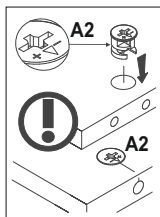
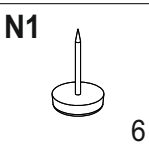
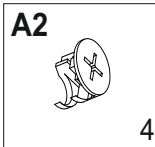

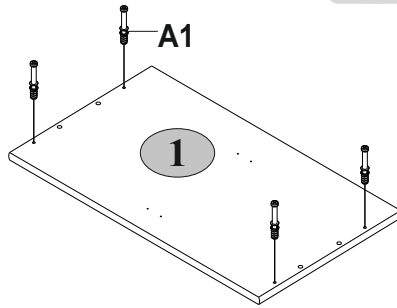
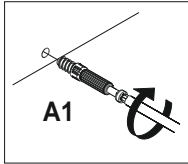
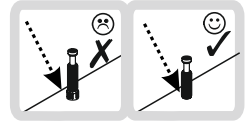
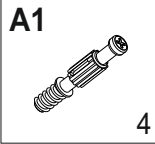

8

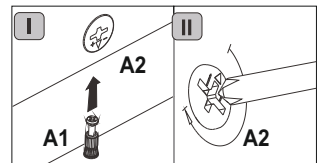
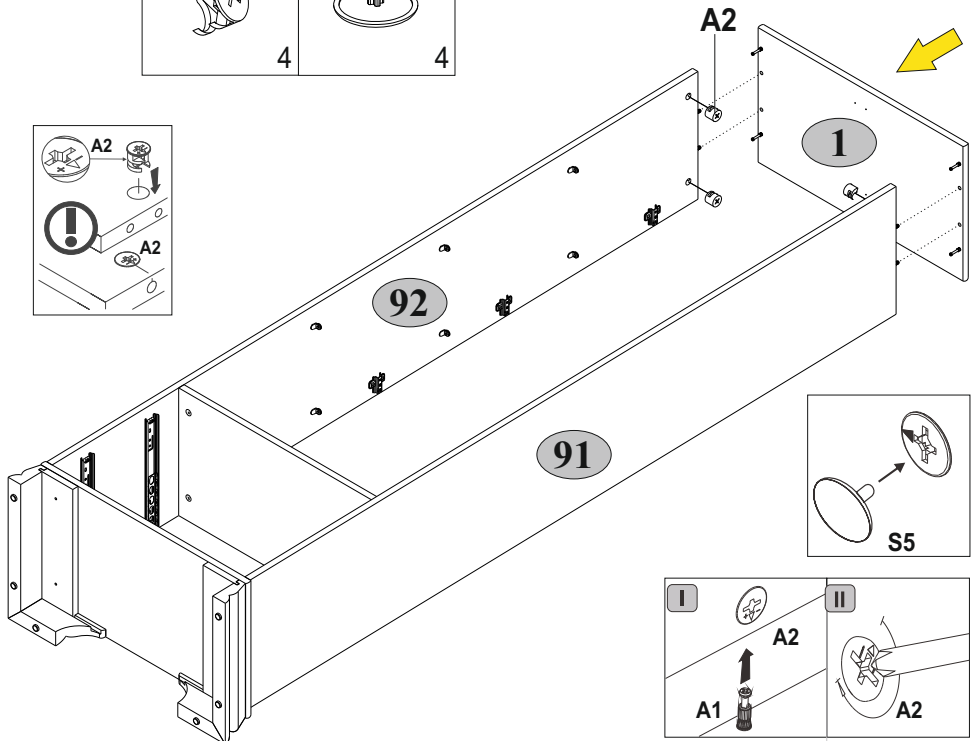
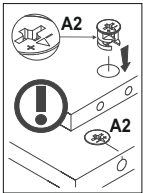
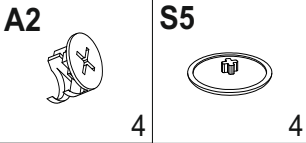

9



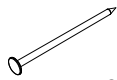

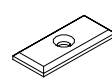

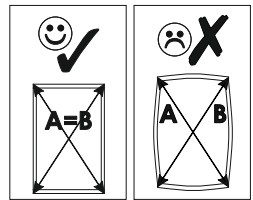
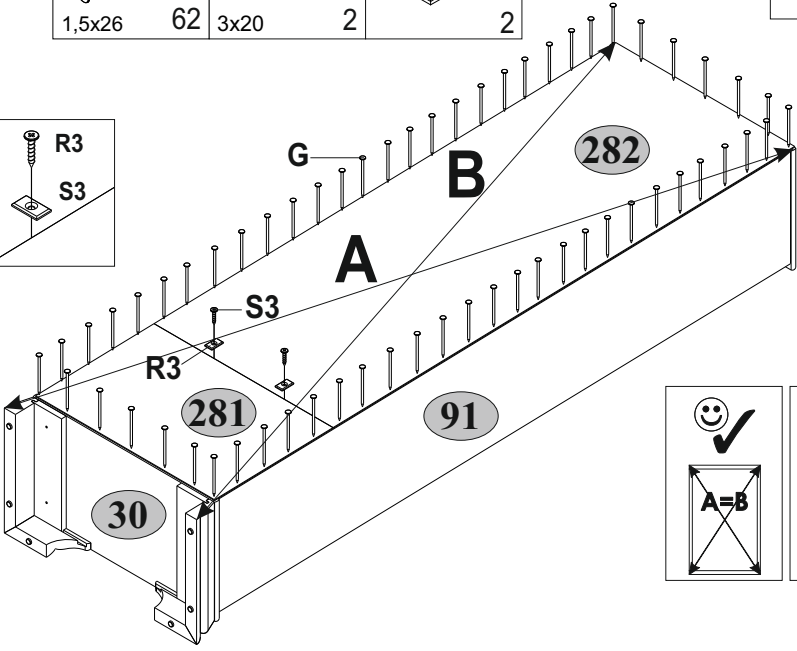
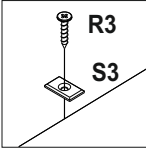
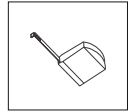
10

| | | |
|--|--|---|
| G  1,5x26 62 | R3  3x20 2 | S3  2 |
|--|--|---|

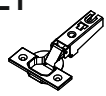

11

| | | | |
|--|---|---|---|
| E1  4 | R102  3,5x16 8 | H18  1 | M12  M4x25 2 |
|--|---|---|---|

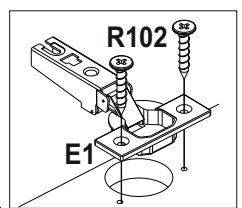
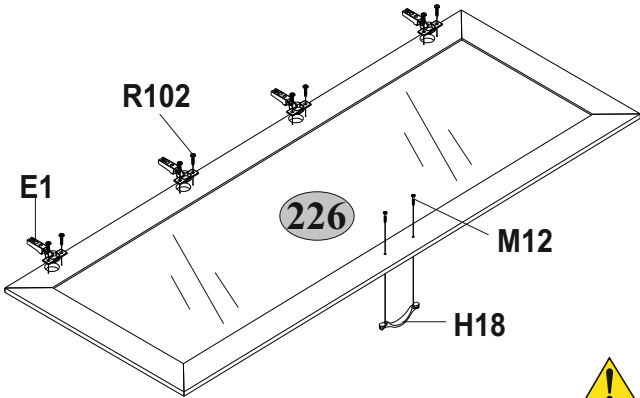

12 x2

C1

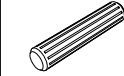

8x35

10

R27



5,0x13

8

Z10



300

2

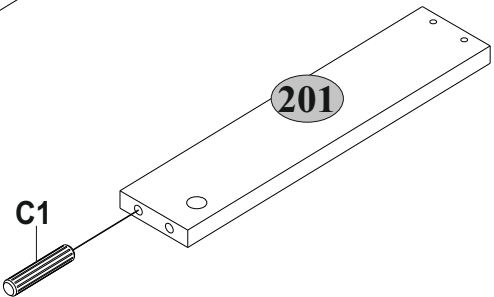
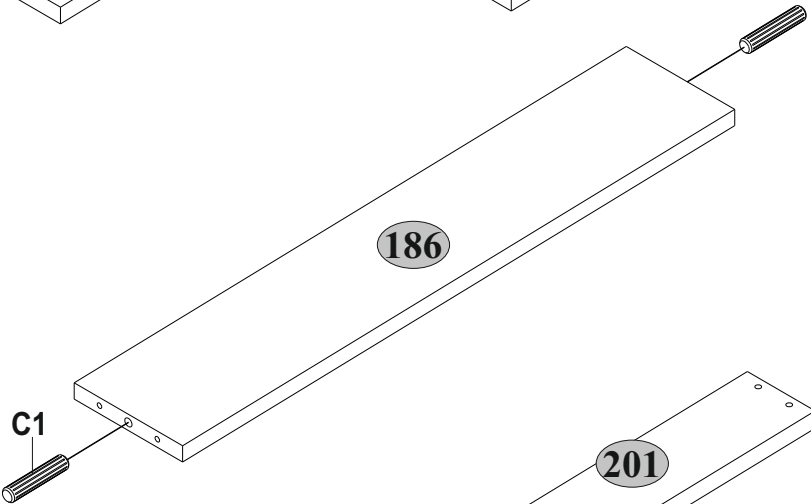
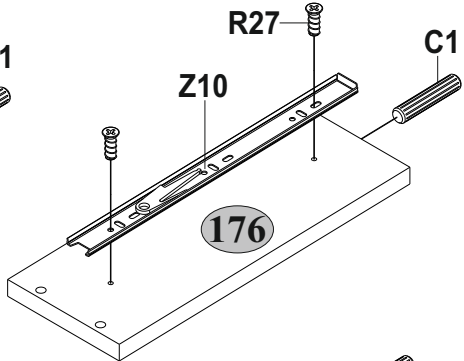
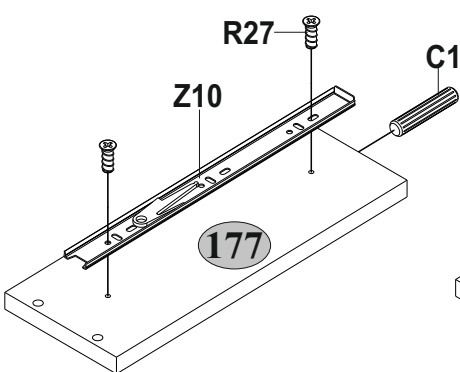
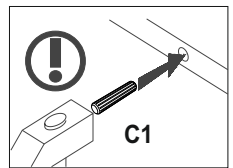
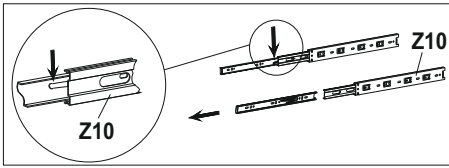
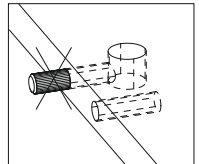

13 x2

A1



10

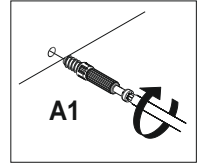

A1

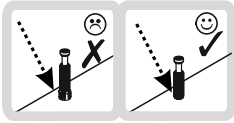
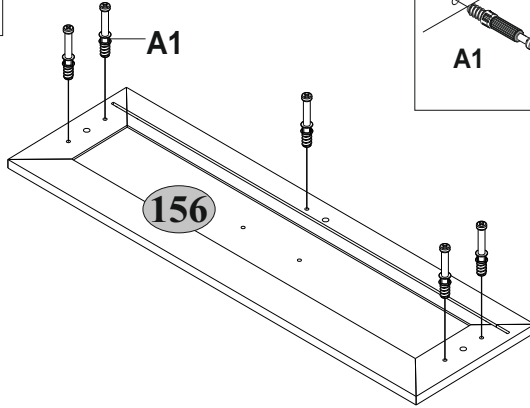

14 x2

A2



8

H18



2

I



1

M1



M4x12 4

R24

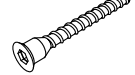

8

S5



8

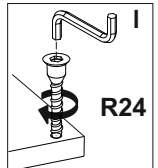
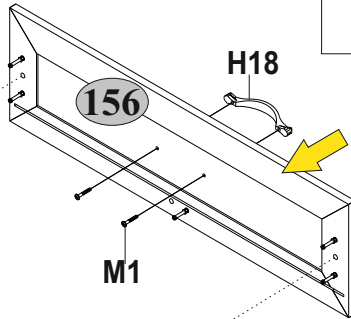
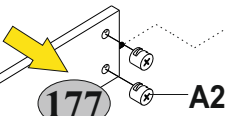
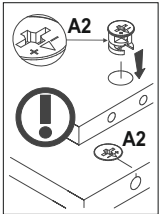

R24

R24

186

176

177

M1

H18

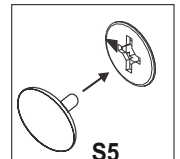
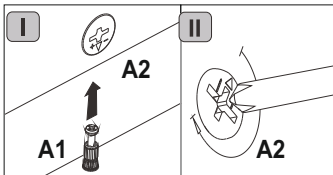

S5

15x2

A2



R3



2

3x20

20

R12



4x40

4

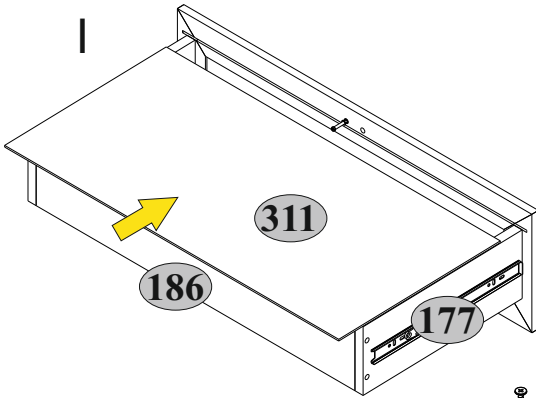
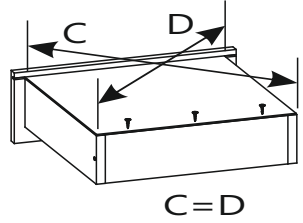

II

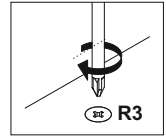
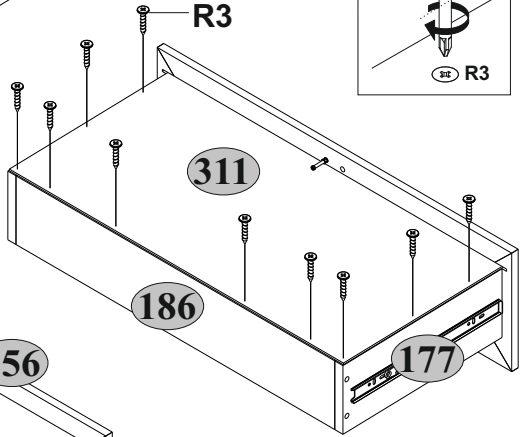

III

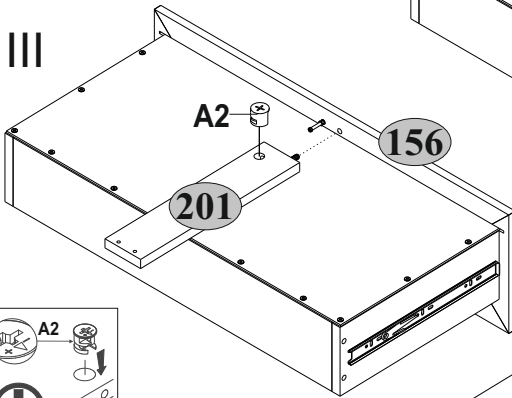

IV

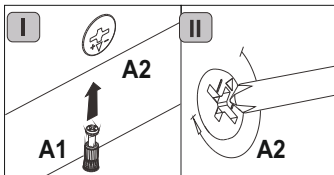
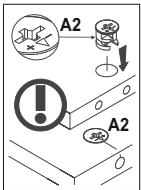
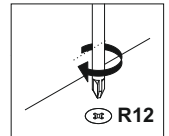
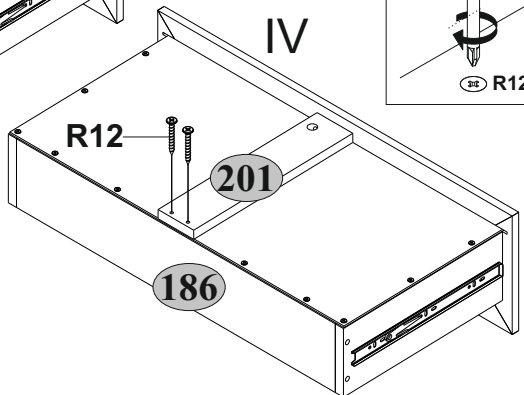

16

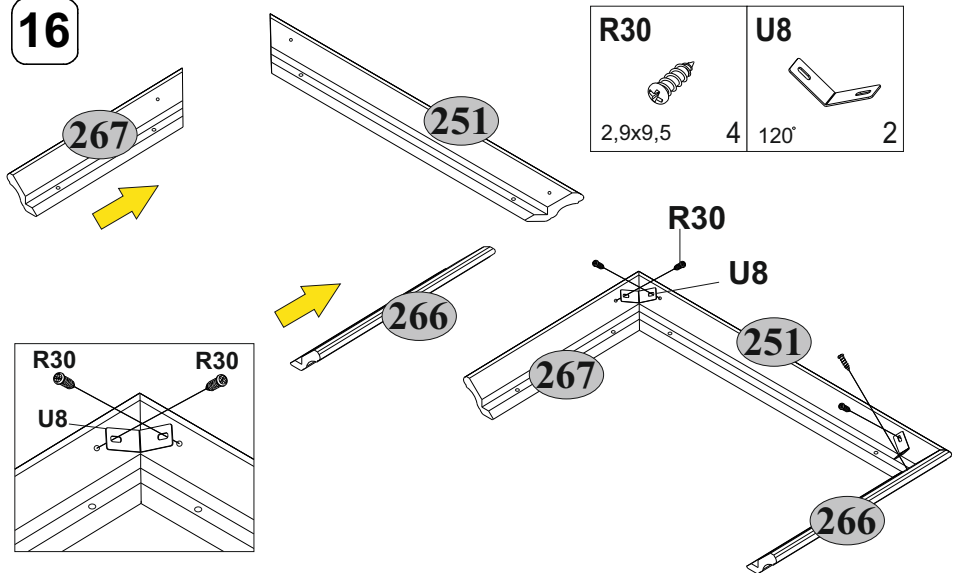

17

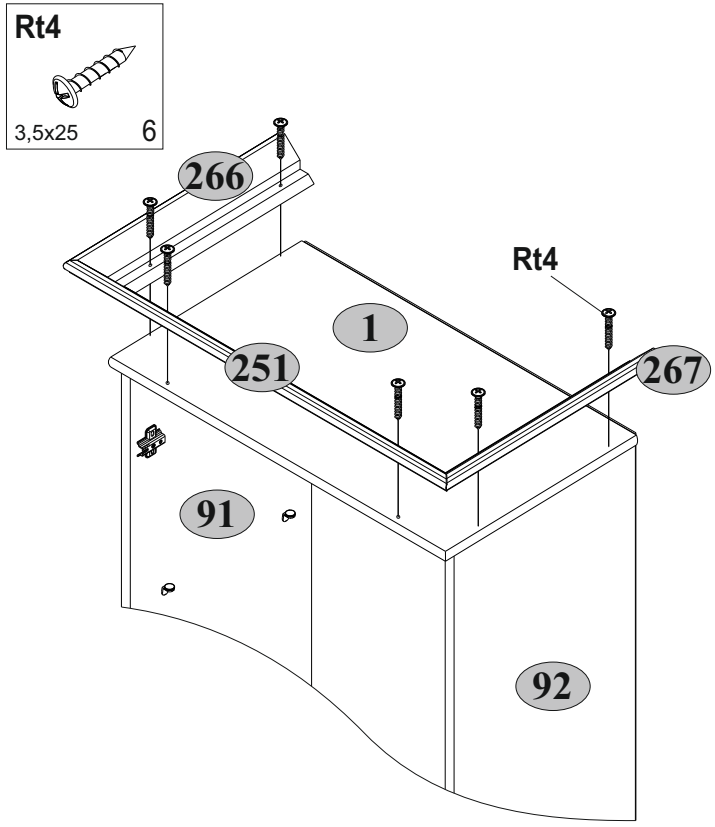

18**B5**

10x50

1

R102

3,5x16

2

Q

6

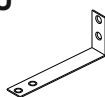
U

1

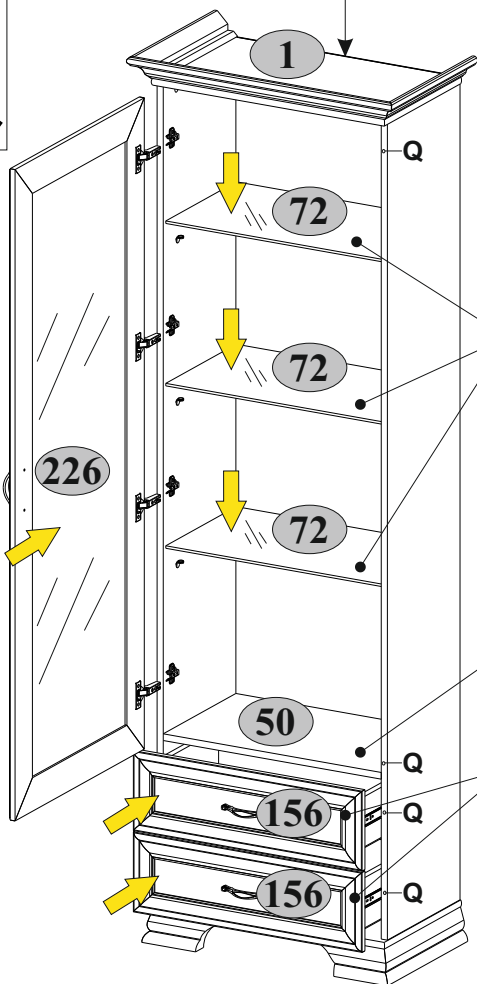
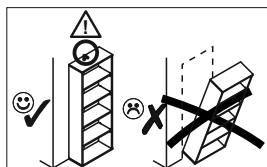
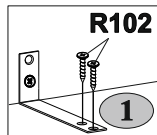
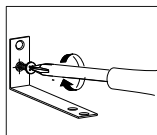
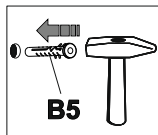
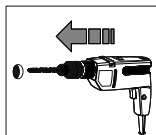
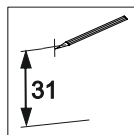
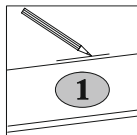
 max.
5 kg max.
10 kg max.
5 kg