





| | | | | |
|---------|------|-----|---|-----|
| 1L,1R | 1985 | 352 | 2 | 2/2 |
| 2, 3 | 770 | 351 | 2 | 1/2 |
| 4 | 770 | 330 | 1 | 1/2 |
| 5 | 770 | 320 | 1 | 1/2 |
| 6 | 770 | 100 | 1 | 1/2 |
| 7 | 769 | 310 | 3 | 1/2 |
| 9L,9R | 1406 | 331 | 2 | 2/2 |
| 10 | 1216 | 235 | 2 | 2/2 |
| 11L,11R | 573 | 331 | 2 | 1/2 |
| 12 | 1982 | 130 | 1 | 2/2 |
| 15 | 1963 | 778 | 1 | 2/2 |

NR 1

B1  ϕ 8x28 x14

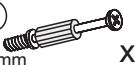
M1  ϕ 15x12mm x14

T1  5x39mm x14

J23  x28

P2  3x20 x6

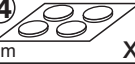
C14  ϕ 20mm x12

NR 2

W1  x4

W2  x12

G5  x24

S6  3x20 x24

F32  24x24x20 x6

S3  3,5x13 x12

NR 3

Y0  ϕ 35
kr0 x10

D6  H2 x10

S8  4x13 x20

E3  6,3x13 x20

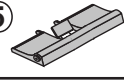
Z5  x4

NR 4

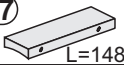
U67  L=148 x4

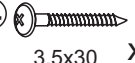
P14  3,5x30 x8

NR 5

F10  x5

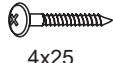
P4  4x25 x5

NR 6

J11  x2

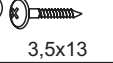
P13  3,5x13 x4

T13  8x50 mm x2

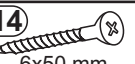
T14  6x50 mm x2

NR 7

O22TC  x6

O21  MAX 6 W x1

C 1/2



<http://www.innostyle-mvg.de>

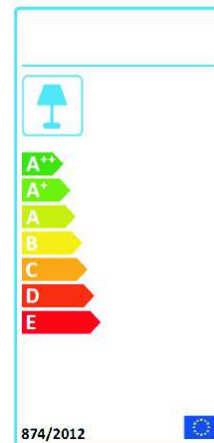

| | | |
|----|----------------|-------------|
| BG | Bulgarisch | Български |
| CS | Tschechisch | čeština |
| DA | Dänisch | Dansk |
| DE | Deutsch | Deutsch |
| ET | Estonisch | Eesti |
| EL | Griechisch | ελληνικά |
| EN | Englisch | English |
| ES | Spanisch | español |
| FR | Französisch | Français |
| FI | Finnisch | suomalainen |
| HR | Kroatisch | hrvatski |
| HU | Ungarisch | magyar |
| IT | Italienisch | Italiano |
| LV | Lettisch | Latvijas |
| LT | Litauisch | Lietuvos |
| NL | Niederländisch | Nederlands |
| PL | Polnisch | Polski |
| PT | Portugiesisch | português |
| RO | Rumänisch | român |
| SK | Slowakisch | slovenský |
| SL | Slowenisch | slovensčina |
| SV | Schwedisch | Svenska |



Möbelvertriebsgesellschaft mbH & Co.



1

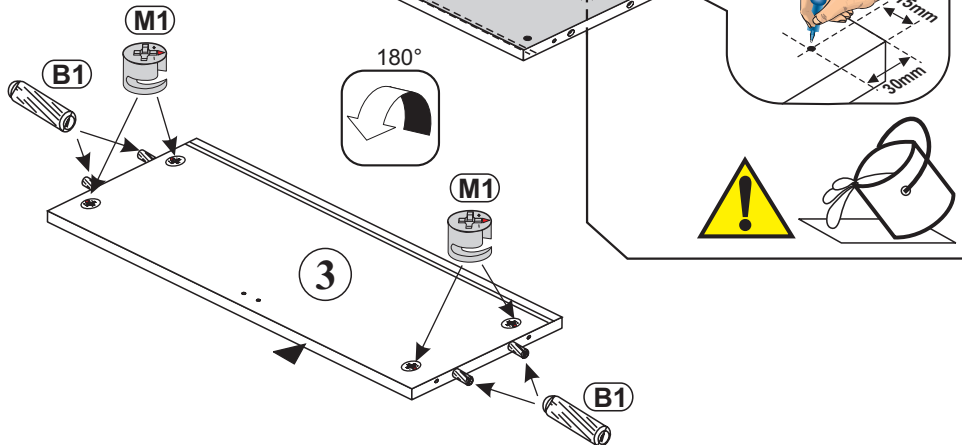
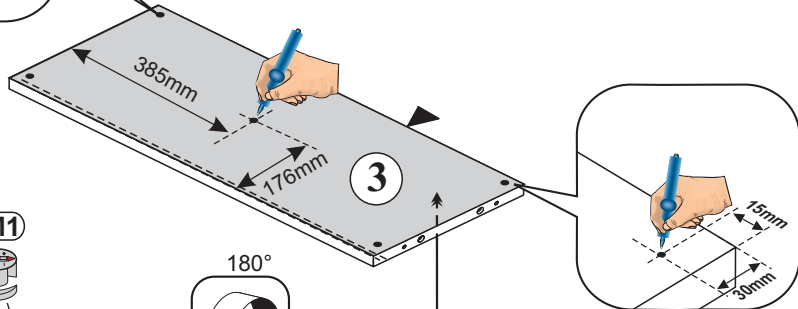
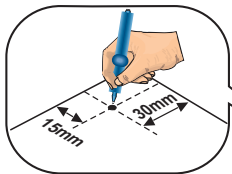
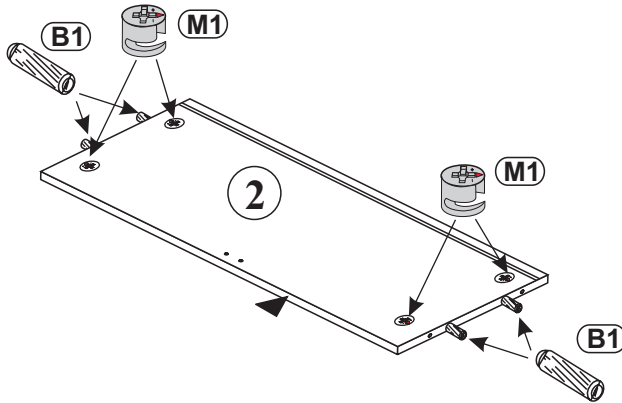
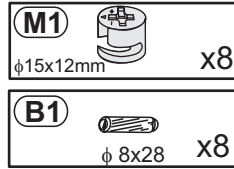
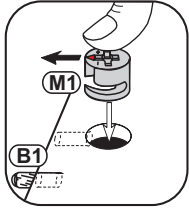

2

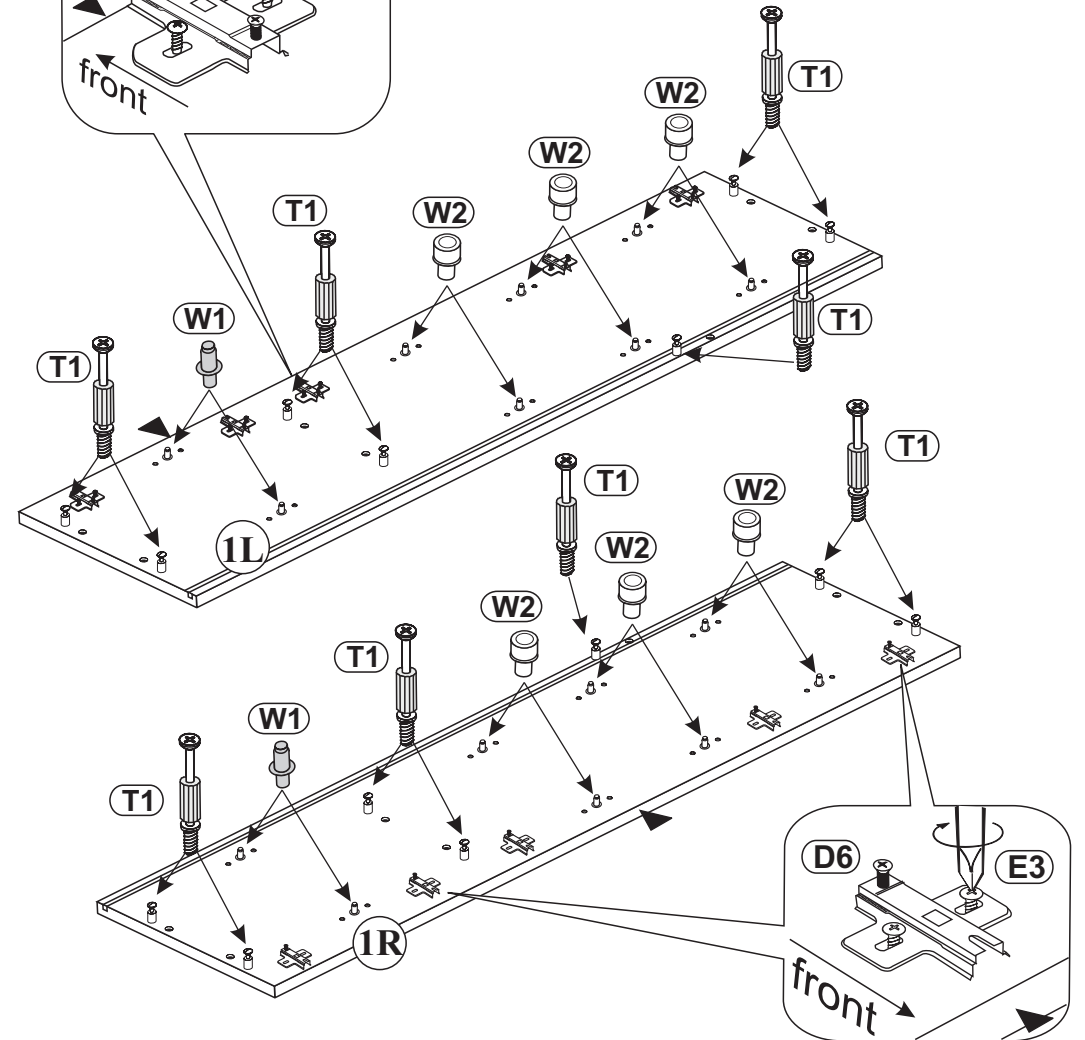
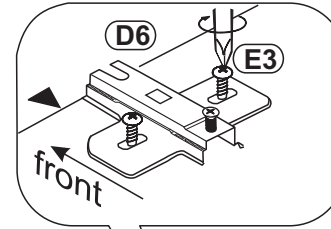
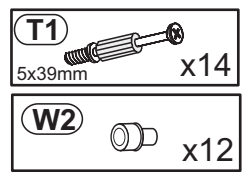
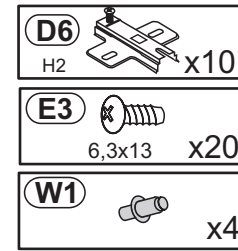
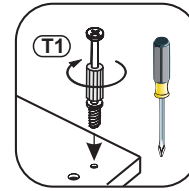

3

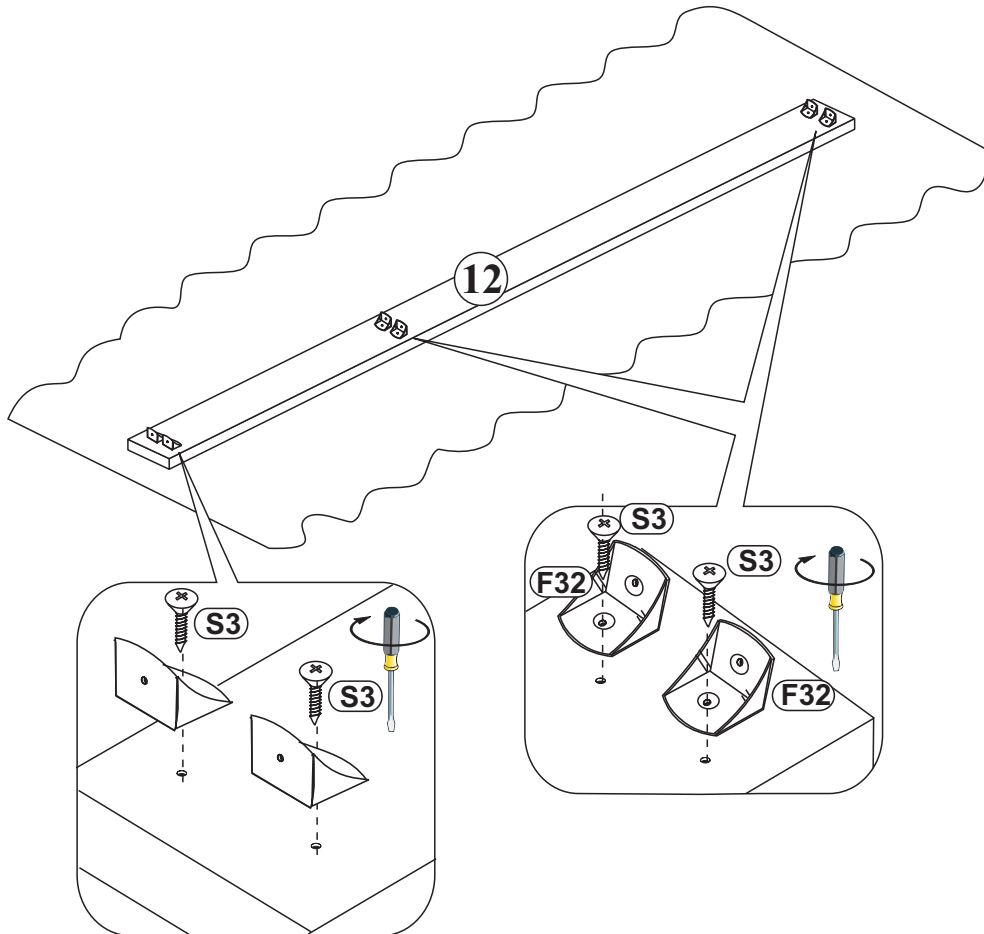
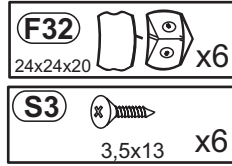
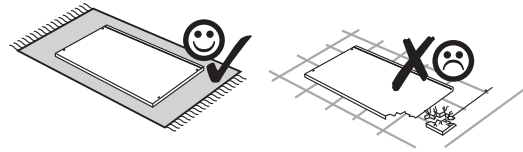

4

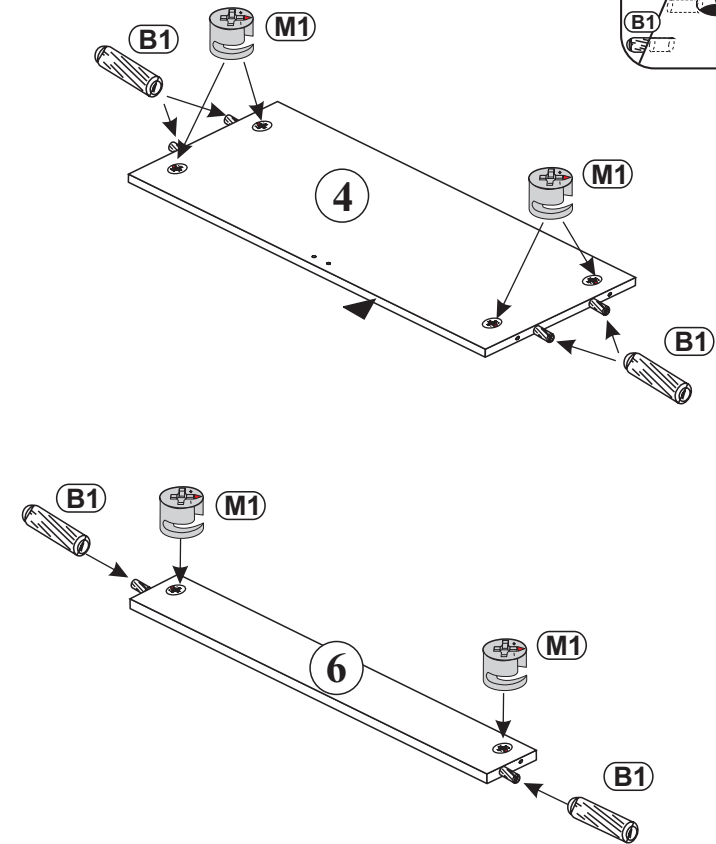
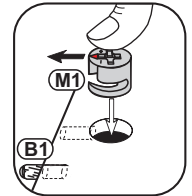
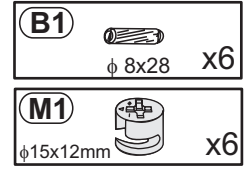

5

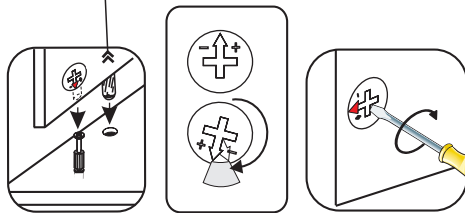
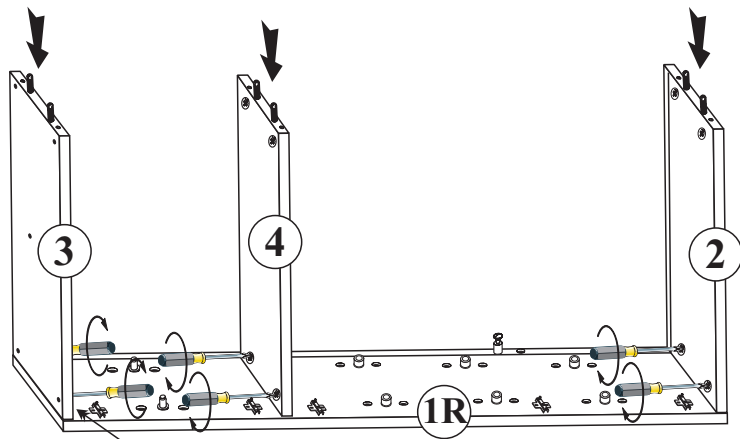

6

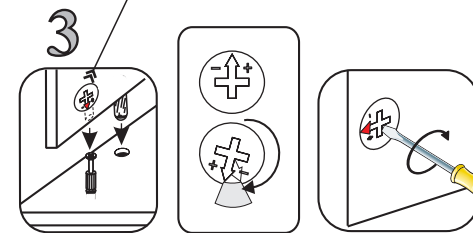
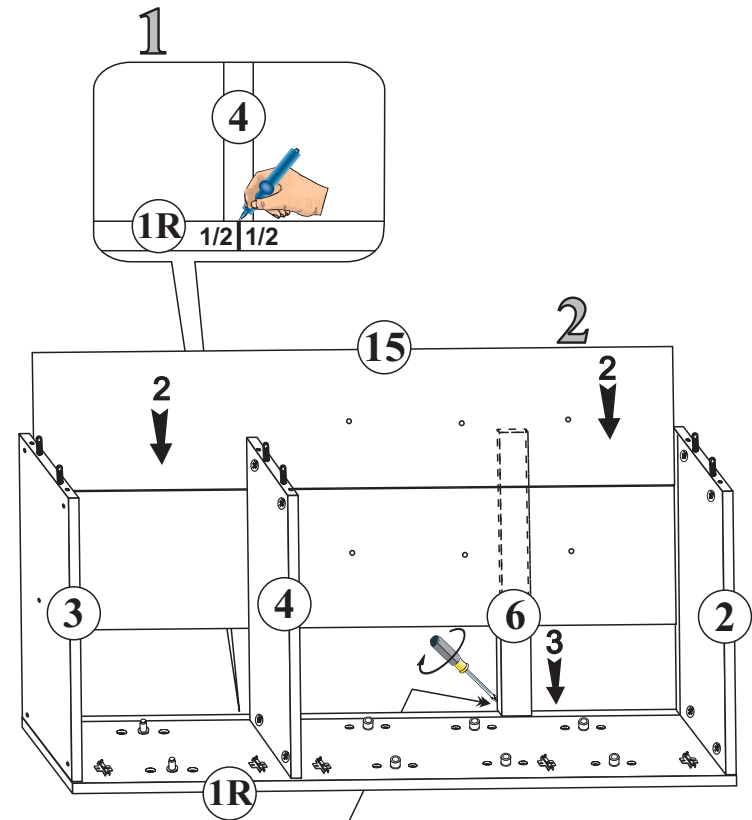

7

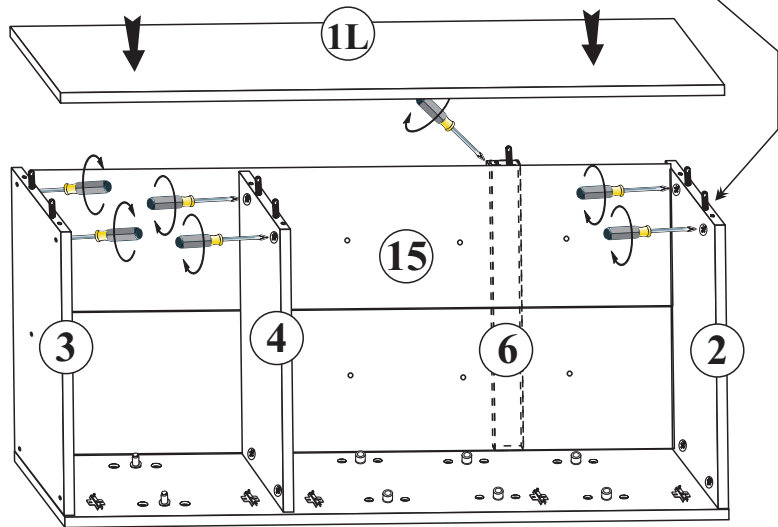
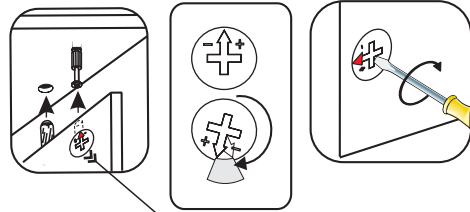

8

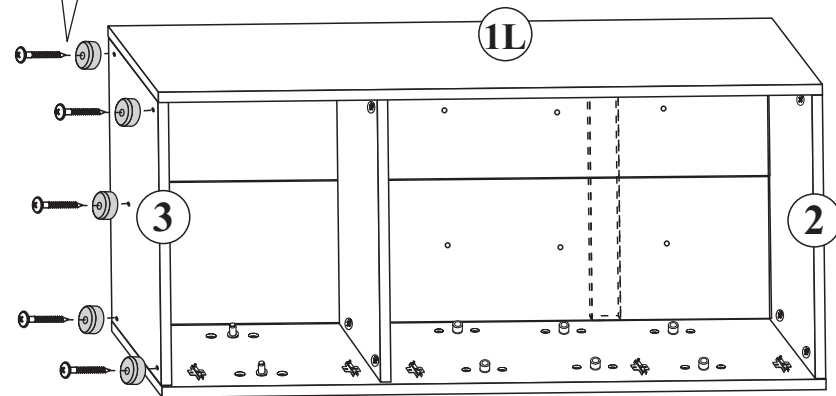
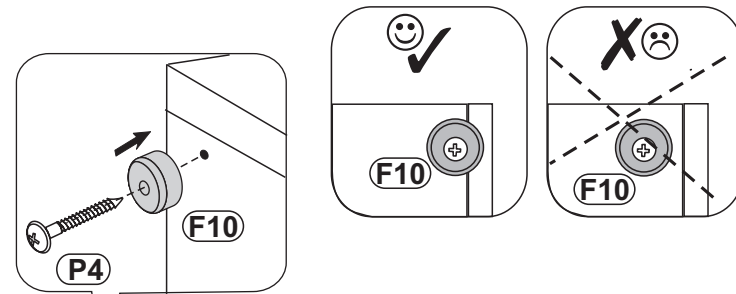
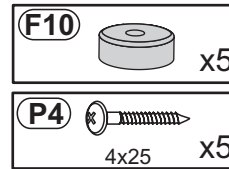

9

P2  3x20 x6 **J23**  x28

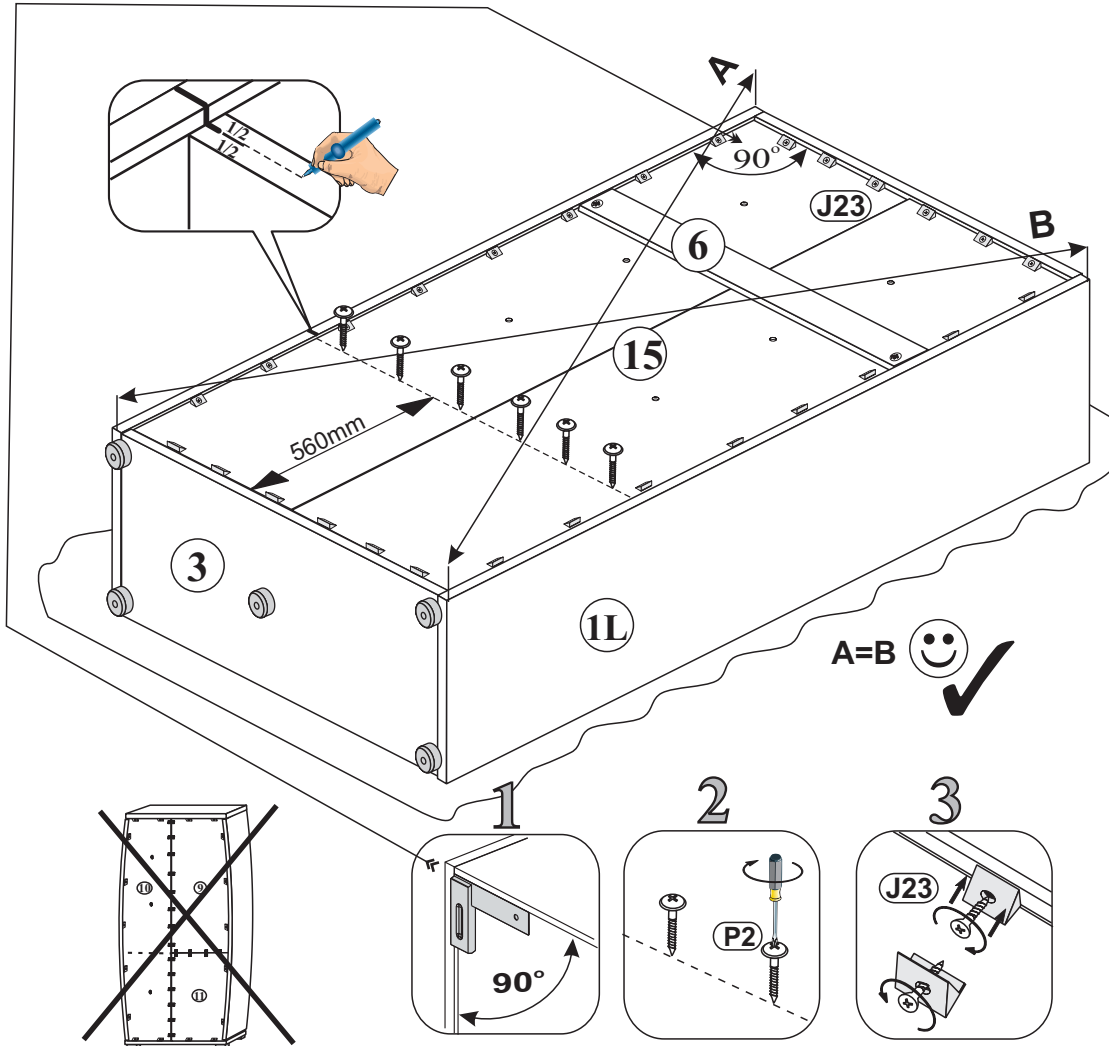
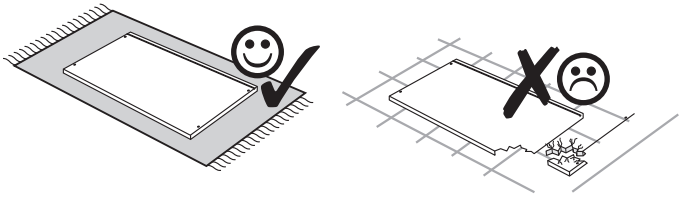

10

O22TC  x6

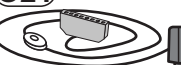
O21  MAX 6 W x1

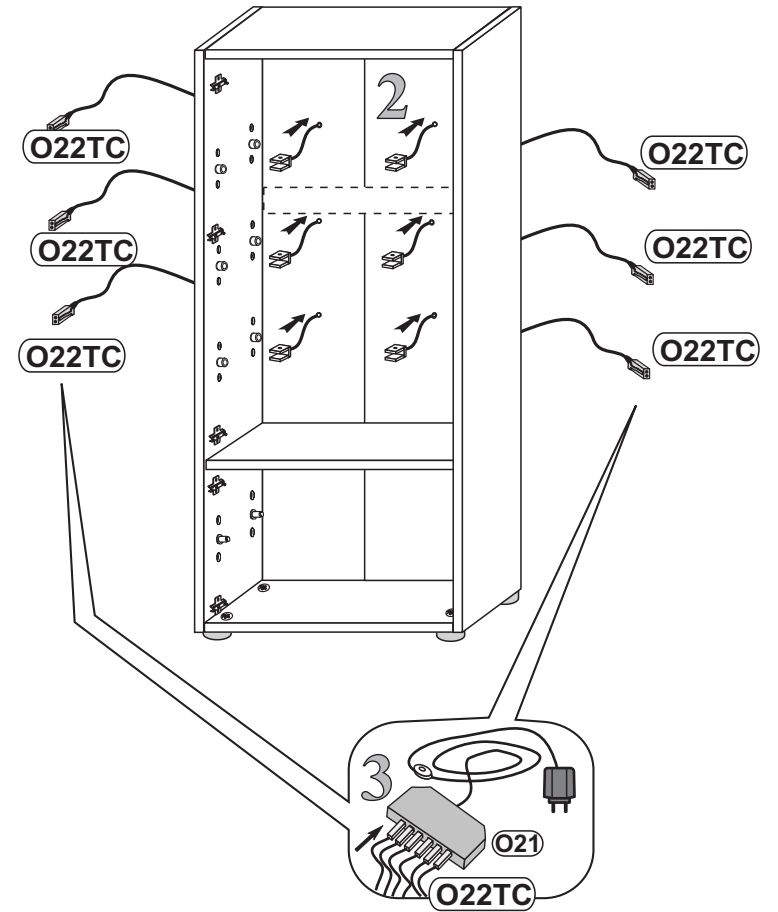
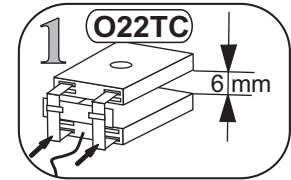

11

- J11** x2
- P13** 3,5x13 x4
- T13** 8x50 mm x2
- T14** 6x50 mm x2

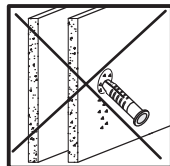
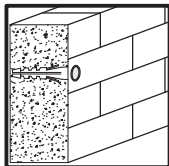
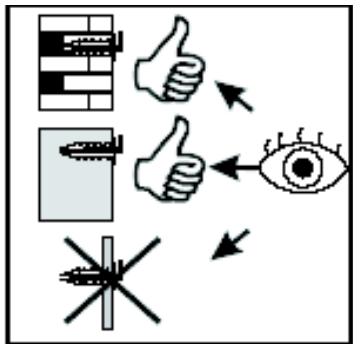
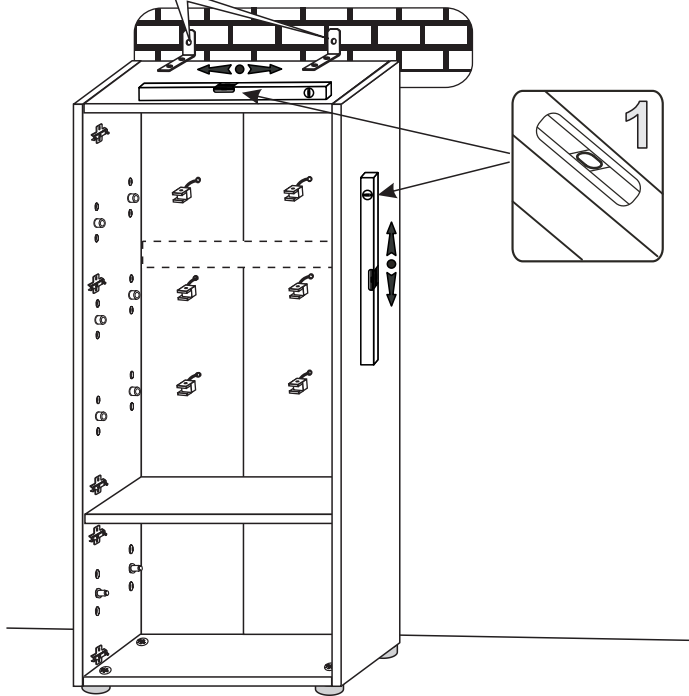
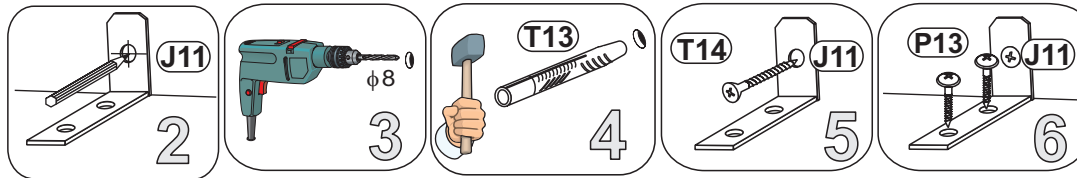

12

- C14** $\phi 20$ mm x12

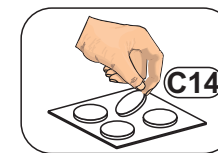
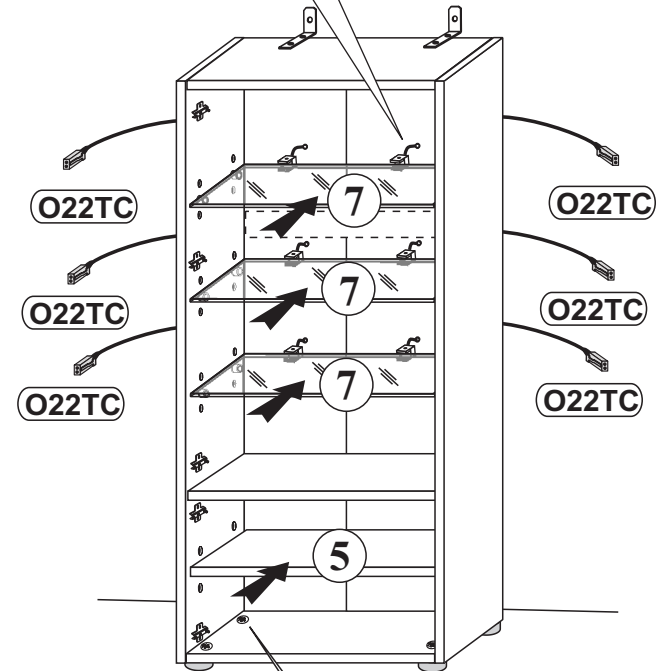
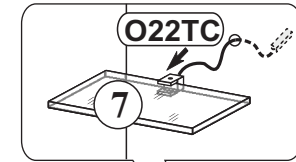

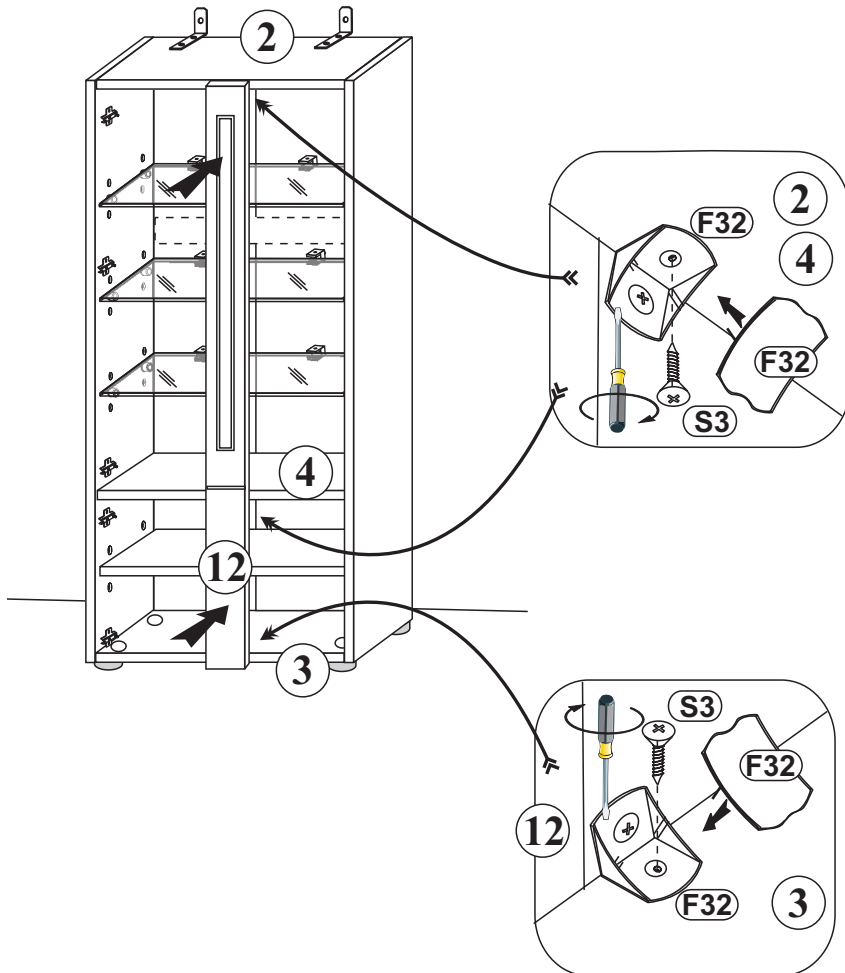
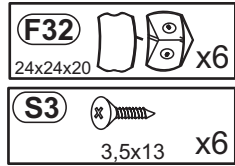

13

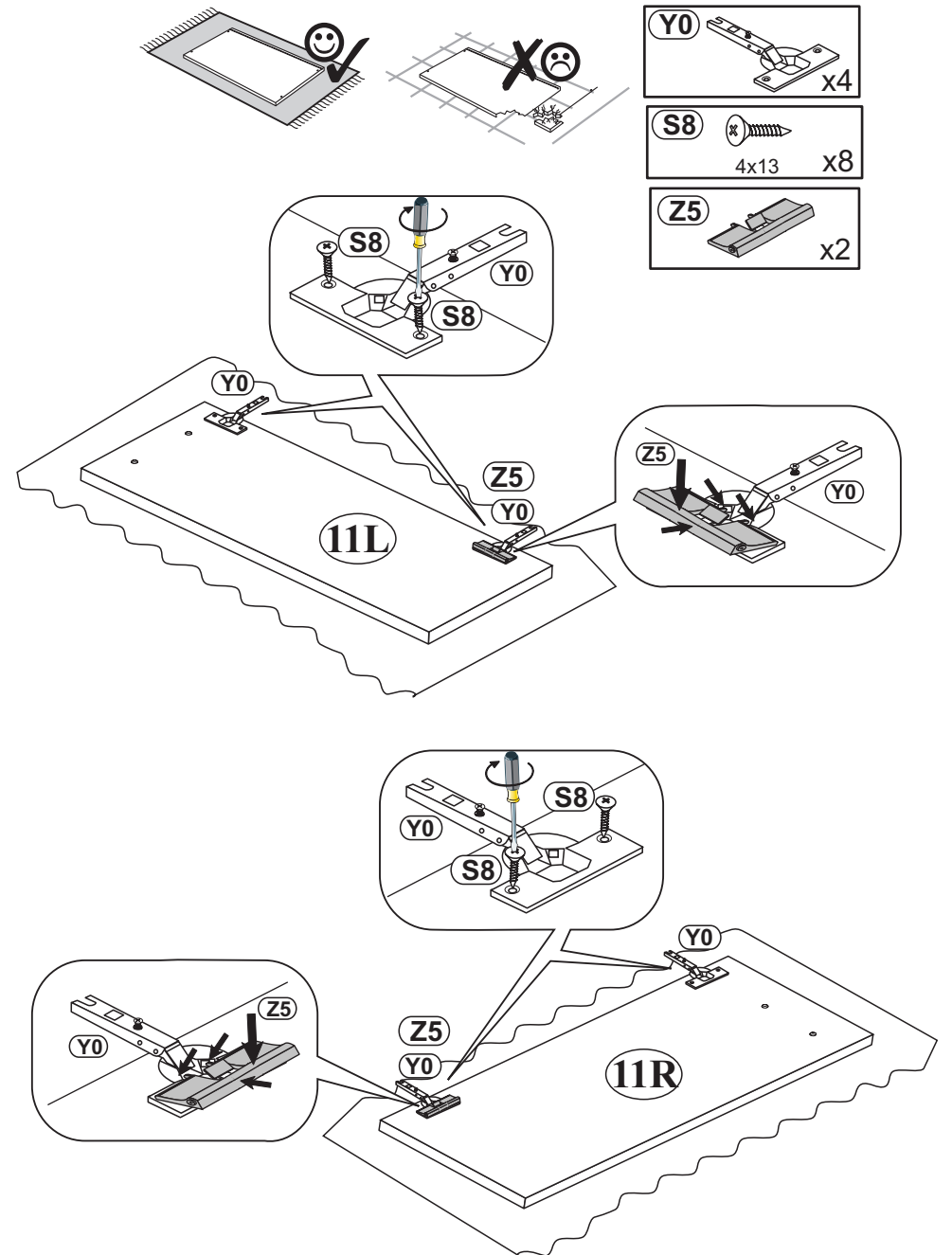

14



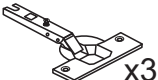
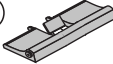

15

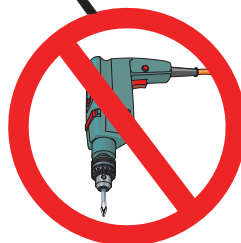
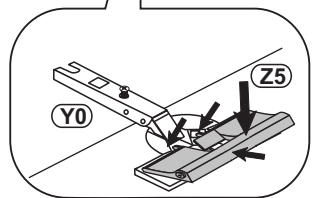
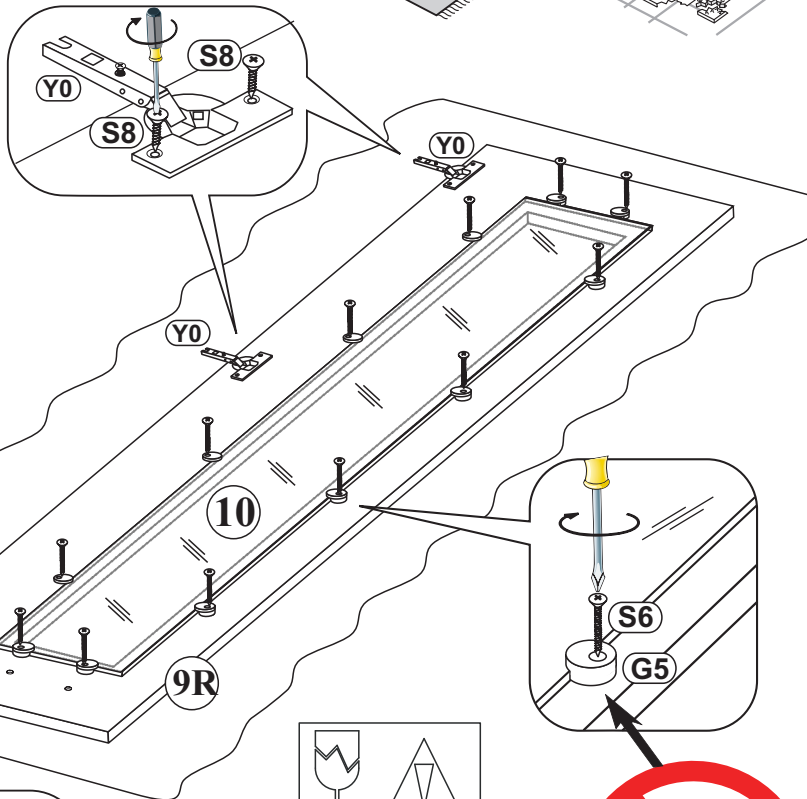
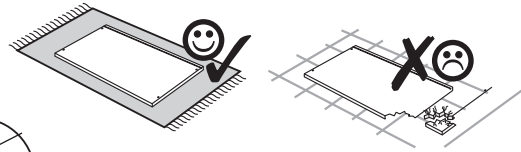
- G5**  x12
- Y0**  x3
- Z5**  x1
- S6**  3x20 x12
- S8**  4x13 x6

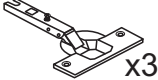

16

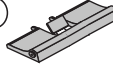
- G5**  x12
- Y0**  x3
- S6**  3x20 x12
- S8**  4x13 x6
- Z5**  x1

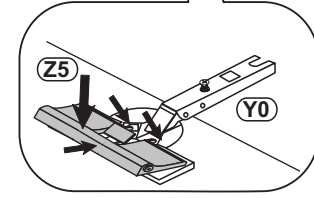
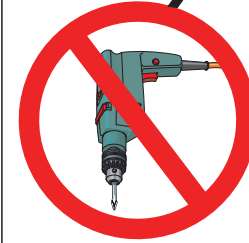
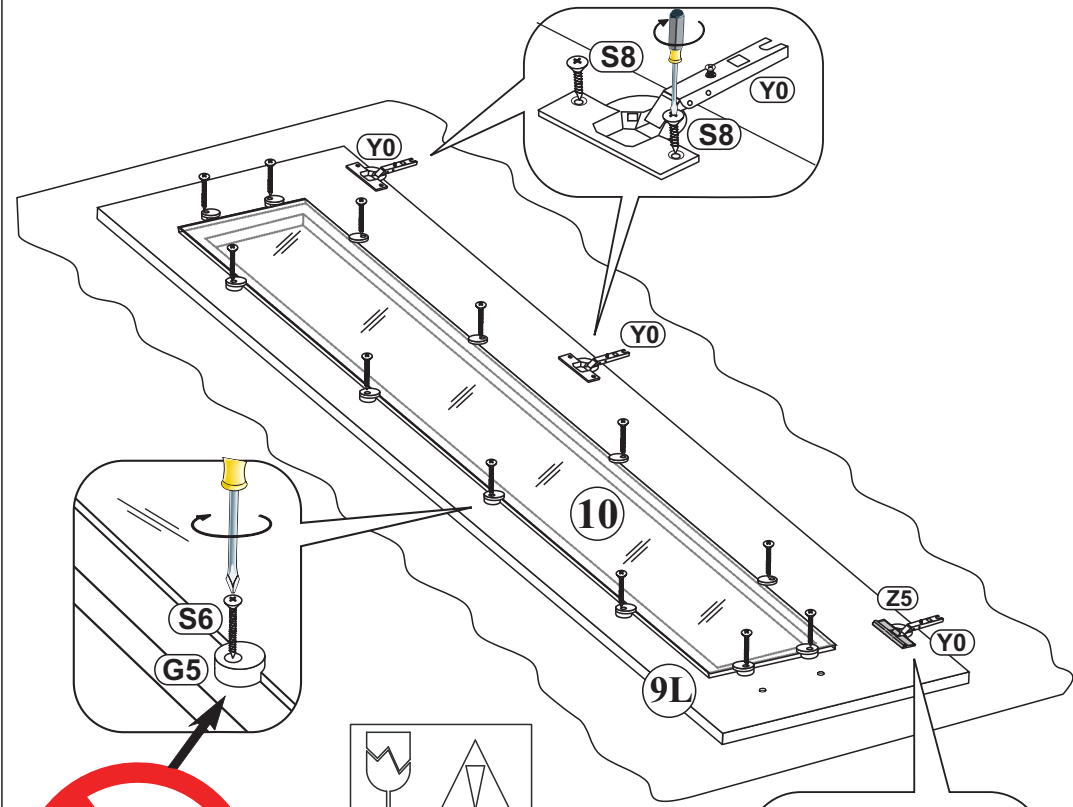
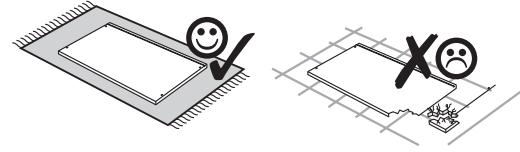

17

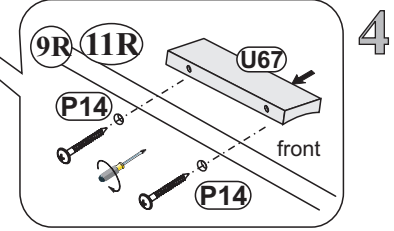
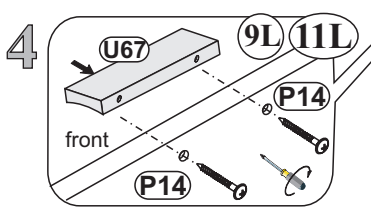
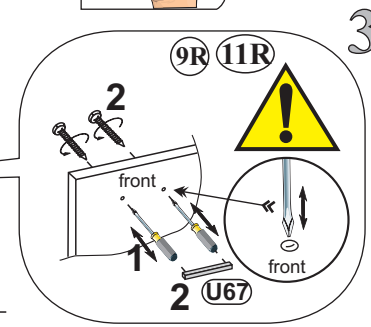
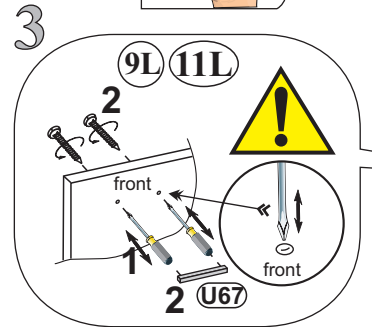
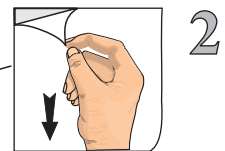
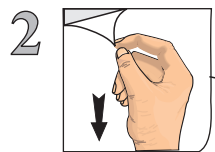
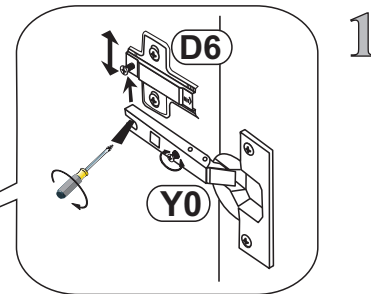
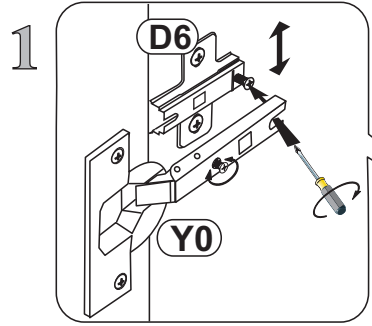
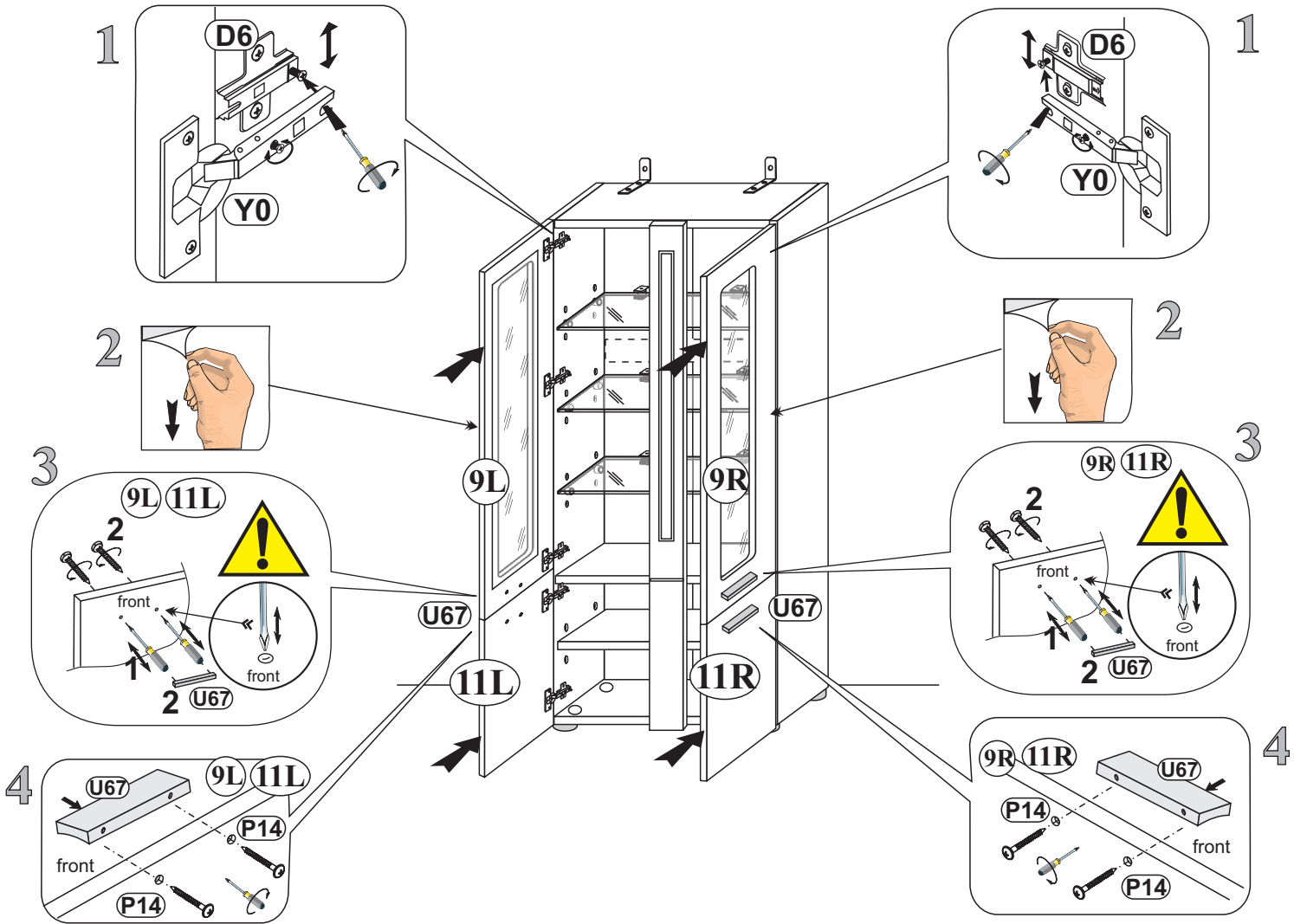
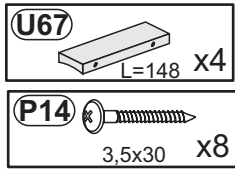

18

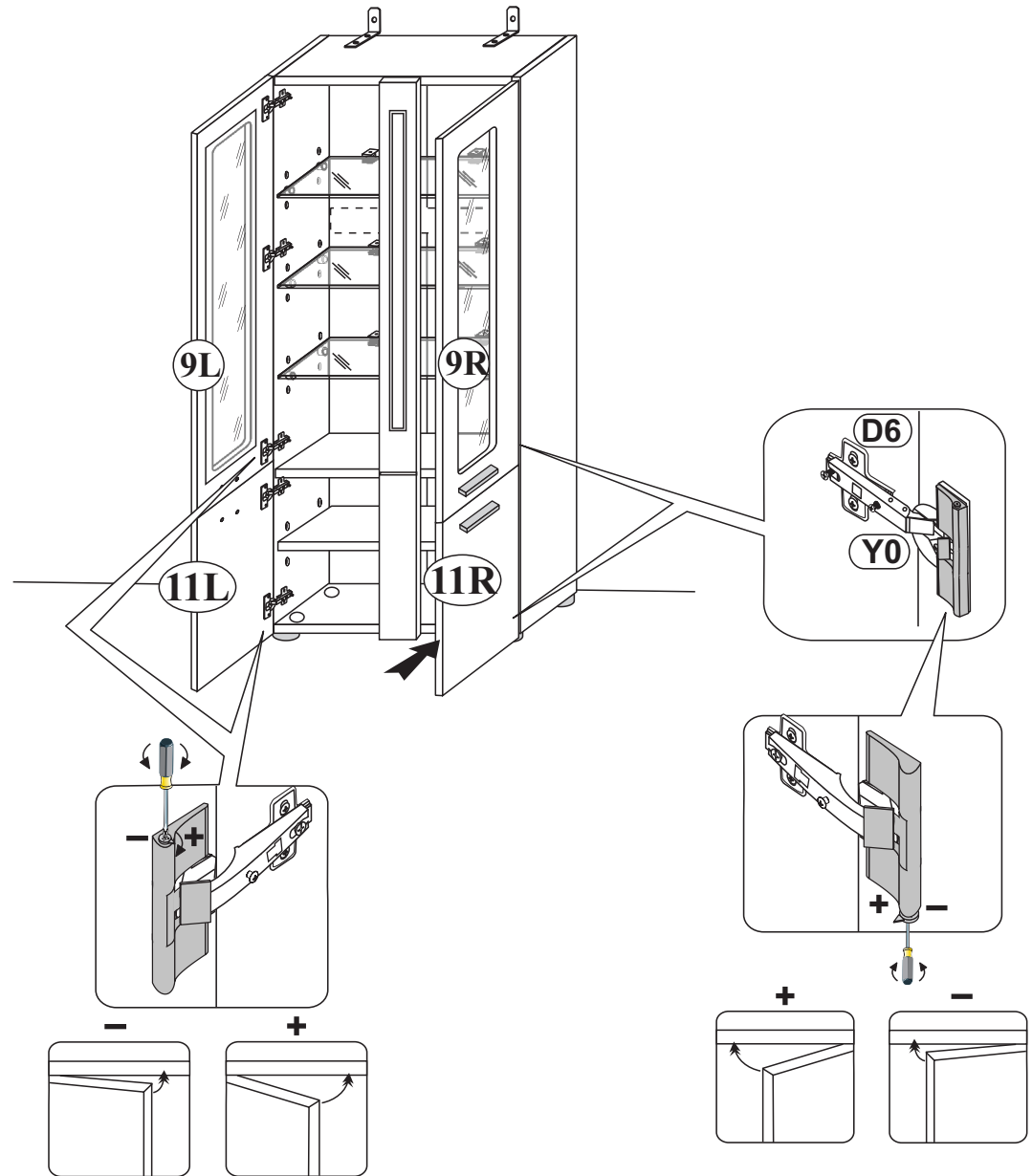
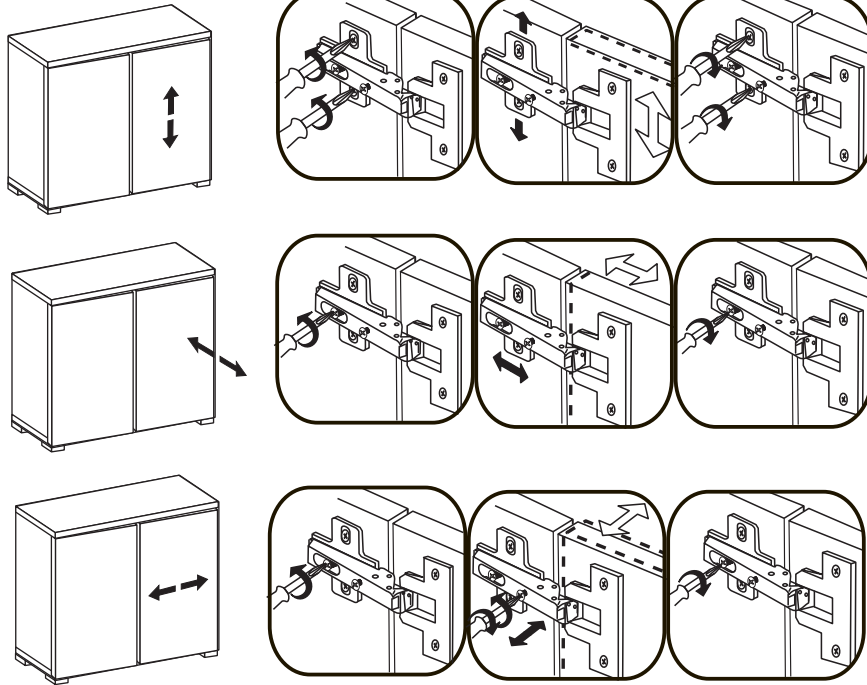

D CH AT LI LU Kleinstele und Verpackungsfolien bei der Möbelmontage von Kindern fernhalten!
GB US Keep small parts and plastic film out of the reach of children!
FR BE NC Tenir les petites pièces et les films plastiques hors de la portée des enfants!
NL Hou de kleine onderdelen en de plastic folie uit de buurt van kinderen!
IT Tenere i componenti di piccole dimensioni e le pellicole di plastica fuori dalla portata dei bambini!
SI Malhni delov i foliju za pakovanje priklom montaži pohištna priane izven dosega otrok!
XS HR BA Mahe dijelove i foliju za pakovanje priklom montaže namještaja držite dalje od djece
HU Bútorészeket közbden a kis alkatrészek és a csomagoló fóliák gyerekektől távol tartandók!
BG Дребни детайли и опаковъчни фолиа да се държат далеч от деца при монтажа на мебелите!
CZ SK Vid montáži nábytku uchovávejte drobné díly a obalové fólie z dosahu dětí!
SE Vid möbelföringen ska smådelar och förpackningsfolien hållas oåtkomliga för barn!
RO Țineți departe de copil piesele mici și folia de ambalat la montarea mobiliei!
ES ¡Durante el montaje, mantenga alejados de los niños las piezas pequeñas y el material plástico de embalaje!

D CH AT LI LU Möbelmontage muss auf ebennem Untergrund erfolgen. Bei Wandmontagen immer geeignetes Befestigungsmaterial verwenden.
GB US Furniture must be assembled on a flat surface. For assembly to the wall only use suitable fixing materials.
FR BE NC Le meuble doit être monté sur une surface plane. Pour le montage mural, utilisez des accessoires de fixation adaptés au type de mur.
NL De meubels dienen op een vlakke ondergrond te worden gemonteerd. Voor wandmontage moeten geschikte bevestigingsmaterialen worden gebruikt.
IT Il montaggio dei mobili deve avvenire su un fondo piano. Per il montaggio si prega di utilizzare solo materiali adatti.
SI Pohištvo je treba montirati na ravni podlagi. Pri stenski montaži vedno uporabite pritrilveni material.
XS HR BA Namještaj se mora montirati na ravnoj podlozi. Kod montaže na zid uvijek koristite prikladan materijal za pričvršćivanje.
HU A bútorcszerelési silk felületen kell végezni. Falra szereléshez mindig megfelelő rögzítianyagot kell használni.
BG Материалът на мебелите да се извършва на равна основа. При стенен монтаж винаги да се използва подходящ крепежен материал.
CZ SK Montáž nábytku provádějte na rovném podkladu. Při montáži na stěnu používejte vždy vhodný příslušenací materiál.
SE Monteringen av möbeln måste göras på jämnt underlag. Vid väggmontering ska lämpligt uppfästingsmaterial användas.
RO Montarea mobiliei trebuie să se realizeze pe o pardoseală dreaptă. La montarea la perete utilizați întotdeauna material de fixare adecvat.
ES El montaje debe efectuarse sobre una superficie uniforme. En el montaje mural emplee siempre el material de fijación adecuado.

D CH AT LI LU Bitte beachten Sie die Montageanleitung. Halten Sie immer die angegebene Wattzahl ein. Verhindern Sie einen Hitzestau.
GB US Please observe the assembly instructions. Do not exceed the max. given wattage. Ensure that the heat is not allowed to build up.
FR BE NC Veuillez respecter la notice de montage. Respectez impérativement le nombre des watts maximal. Veillez à éviter toute accumulation de chaleur.
NL Lees a.u.b. de montagehandleiding door. Hou de beslist aan het max. opgegeven wattage. Zorg ervoor dat geen hittehuwning onstaat.
IT Attenersi alle istruzioni di montaggio. Rispettarsi rigorosamente il numero di watt max. indicato. Assicurarsi che non si verifichi un accumolo di calore.
SI Upoštevajte navodila za montažo. Vedno upoštevajte navedeno število vatov. Preprečite zastoj vročine.
XS HR BA Obratite pažnju! Vas pozor na uputu za montažu. Uvijek se pridržavajte navedenog broja vai. Izbjegavajte zastoj vrućine.
HU Vegye figyelembe a szerelési útmutatót. Mindig tartsa be a megadott wattszámot. Akadályozza meg a hőelődést.
BG Моля, вземете под внимание ръководството за монтаж. Спазвайте винаги посочените ватове. Избягвайте акумулиране на топлина.
CZ SK Dodržujte prosím návod k montáži. Vždy dodržujte uvedenou hodnotu výkonu (watt). Zabráňte tak přehřívání.
SE Följ monteringsanvisningen. Följ alltid angivet watttal. Undvik att hetta uppstår.
RO Respectați instrucțiunile de montaj. Respectați întotdeauna numărul de watt impus. Evitați acumularea de căldură.
ES Le rogamos que tenga presente las instrucciones de montaje. Respete siempre el número indicado de vatios. Evite la acumulación de calor.

D CH AT LI LU Halten Sie die max. zulässigen Belastungswerte der Möbelteile ein. Details siehe Montageanleitung
GB US Comply with the max. permissible loads. For details, please refer to the assembly instructions
FR BE NC Respectez les valeurs de charge max. admissibles des parties de meubles. Pour plus de détails, cf. la notice de
NL Hou de maximaal geoorloofde belastingswaarden van de meubeldelen aan. Voor details verwijzen wij naar de montagehandleiding
IT Rispettare la portata max. permessa degli elementi del mobile. Per dettagli si vedano le istruzioni di montaggio e si vada
SI Upoštevajte največjo dovoljeno obremenitev delov pohištna. Podrobnosti najdete v navodilih za montažo in na
XS HR BA Tartsa be a bútorelemek max. megengedett terhelési értékét. A részleteket lásd a szerelési útmutatóban
HU Snaazáйте мак. допустимите стойности на натоварване на мебелите. За подробности виж ръководството за монтаж
BG Додръжте макс. prípustné hodnoty zaťaženi nábytkových dií. Podrobnosti viz návod k montáži
CZ SK Dodržujte max. přípustné hodnoty zatížení nábytkových dílů. Podrobnosti viz návod k montáži
SE Följ max. tillåten belastning av möbeldelarna. Mer information finns i monteringsanvisningen
RO Respectați valorile de solicitare max. admise pentru corpurile de mobilier. Pentru detalii consultați instrucțiunile de montaj
ES Respete los valores máximos de carga admisibles para las piezas de los muebles. Consulte los detalles en las instrucciones

D CH AT LI LU Zur Möbelföringung ein mit Wasser befeuchtetes, fusselfreies Baumwolltuch verwenden. Geeignigte Flächen immer trockenreiben!
GB US To clean the furniture only use a water dampened lint-free cotton cloth. Once cleaned, always wipe the surfaces dry.
FR BE NC Utilisez un chiffon en coton non pelucheux humidifié avec de l'eau pour nettoyer les meubles. Séchez systématiquement les surfaces
NL nettoyées en les frottant!
IT Gebuik een met water bevochtigde, pluusvrije katoenen doek om de meubels te reinigen. Wrijf gereinigde oppervlakken altijd droog!
SI Per pulire il mobile utilizzare un panno di cotone inumidito d'acqua e che non perde pelucchi. Asciugare sempre le superfici che si sono
XS HR BA upuše!
HU Za čišćenje pohištva uporabljajte vlažno bombažno krpo, ki ne pušča vlaken. Očišćene površine vedno obrišite do suhnega!
BG Za čišćenje namještaja koristite sa vodom navlaženu pamučnu krpu koja ne ispušta vlakna. Očišćene površine uvijek obrišite suhom
CZ SK K čištění nábytku používejte bavlněný hadr neuvolňující vlákna, navlhčený ve vodě. Učištěné plochy vždy utřete do sucha!
SE För möbelföring används en luddfri bomullsduk fuktad med vatten. Rengjorda ytor ska alltid torkas torra!
RO Pentru curățarea mobiliei utilizați o lavetă din bumbac fără scame umezită cu apă. Suprafețele curățate se șterg întotdeauna până se usucă!
ES Emplee un paño de algodón humedecido con agua y libre de pelusa para la limpieza de los muebles. ¡Seque siempre las superficies que ha limpiado!