

Ar.Nr.

IKANO

21046835, 36195428, 37592052,
38014866, 39453266, 43050253,
68408448, 72372030, 75695314,
78392949, 97100308, 97540209

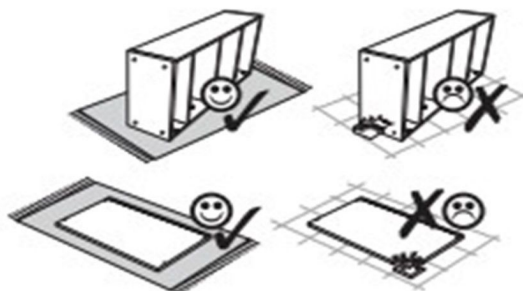
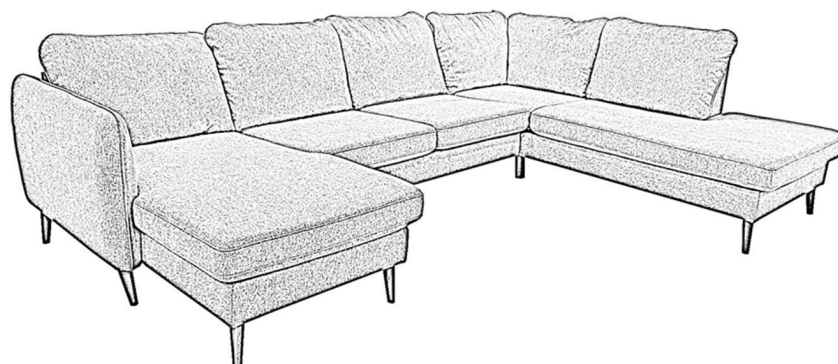

- | | |
|---|-------------------------------------|
| (D) Montageanleitung | (GB) Assembly instructions |
| (FR) Notice de montage | (IT) Istruzioni di montaggio |
| (NL) Handleiding voor de montage | (PL) Instrukcja montażu |
| (CZ) Montážní návod | (SK) Návod na montáž |
| (HU) Szerelési útmutató | (RO) Instrucțiuni de montaj |
| (TR) Montaj talimatı | (RU) Инструкция по монтажу |
| | (HR) Shema montaže |

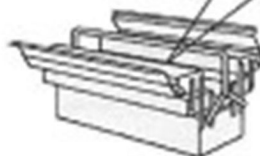
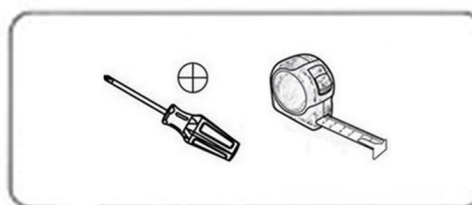
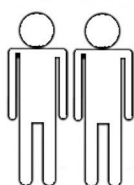

LKZ-40834

Service • Assistenza • Dienstverlening • Serwis
 Servis • Szerviz • Сервисная служба

Name • Nom • Nome • Naam •
 Nazwa • Jméno • Názov • Név •
 Denimire • İsim • Имя
 No. • No. • No. • No. •
 № • № • № • № •
 847.10319753.79996637.53390023.52115367.5
 7332725
 Typ • Type • Tip •
 Típus • Típo • Тип

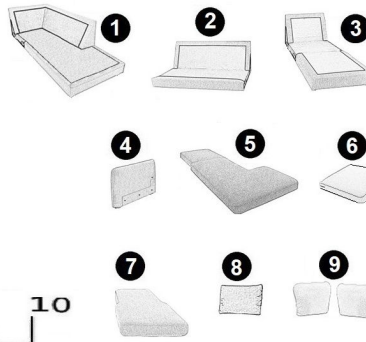
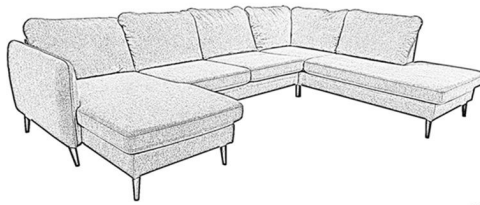

	↙	↘	↗	PCS	♻️
1	2000	810	540	x1	1/3
2	1340	800	540	x1	2/3
3	1380	680	540	x1	3/3
4	850	540	130	x1	3/3
5	1820	910	130	x1	1/3
6	820	470	130	x1	2/3
7	1160	770	130	x1	3/3
8	680	620	130	x4	1/3-x1 2/3-x2 3/3-x1
9	730	470	130	x2	1/3

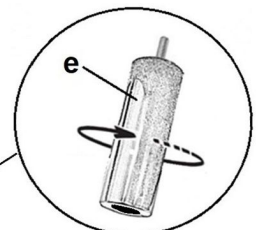
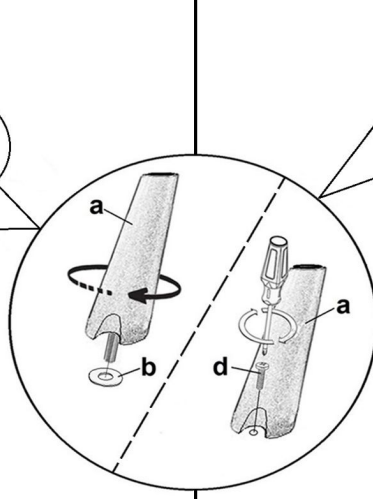
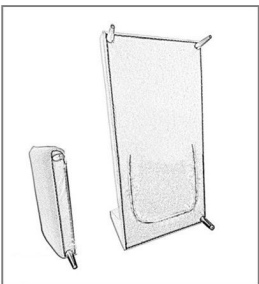
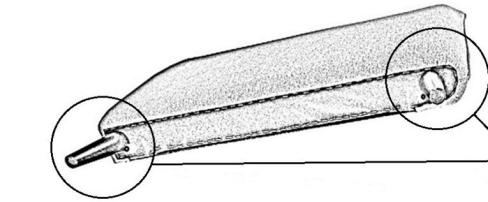
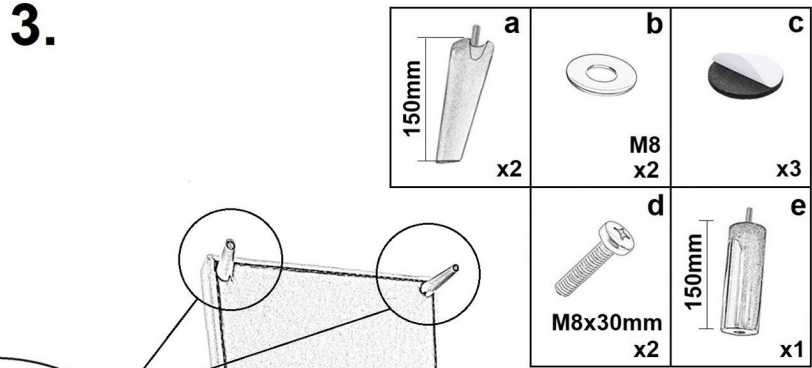
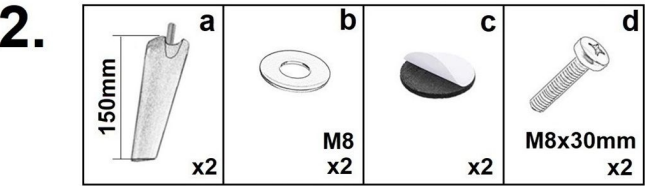
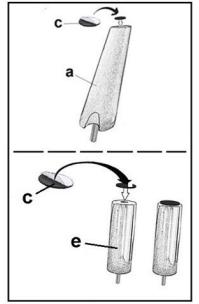
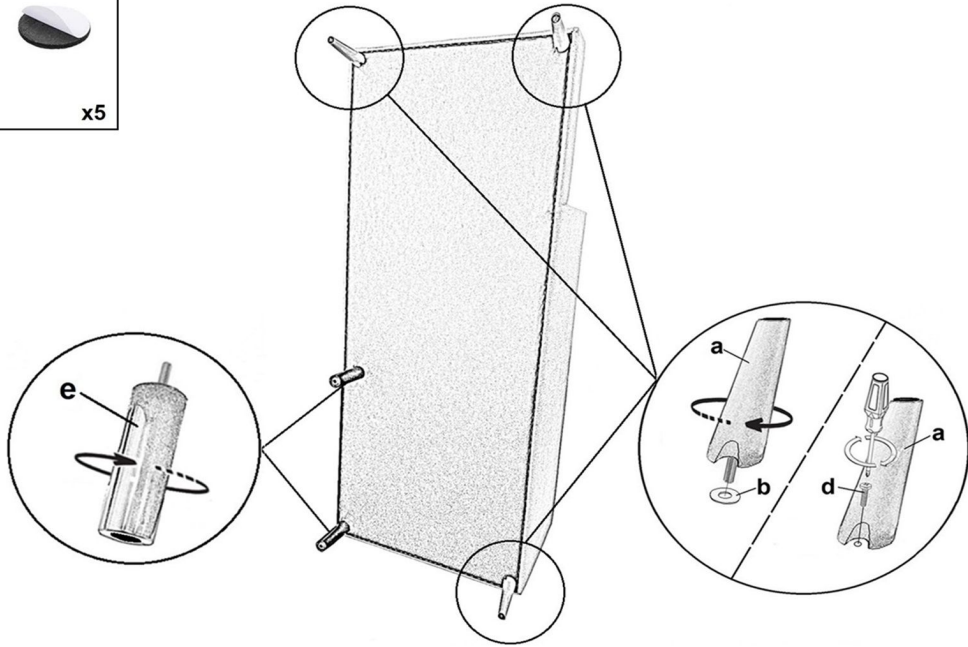
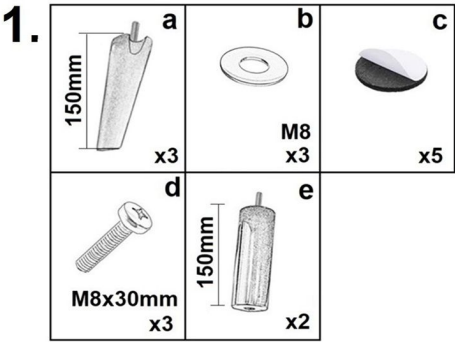
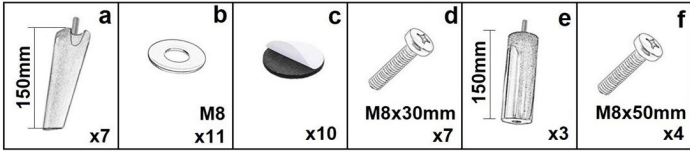

4.

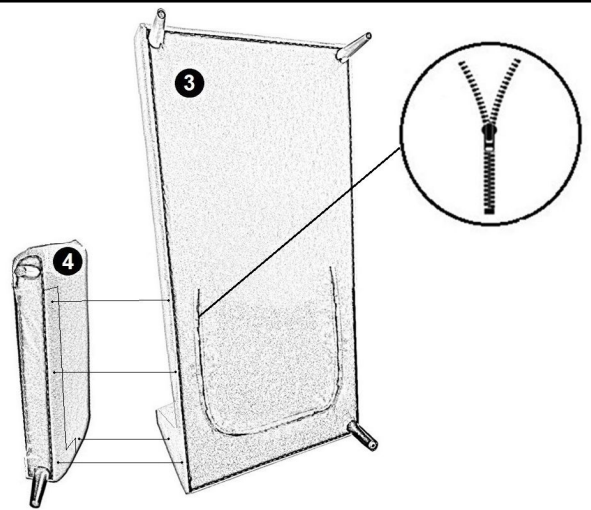
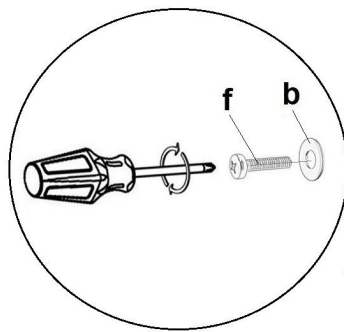
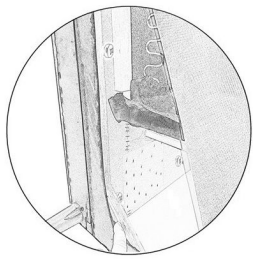
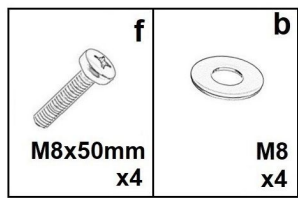

5.

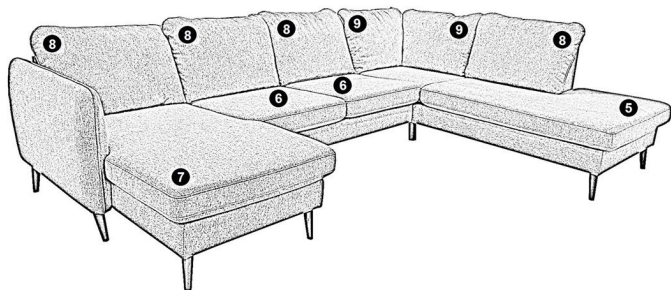
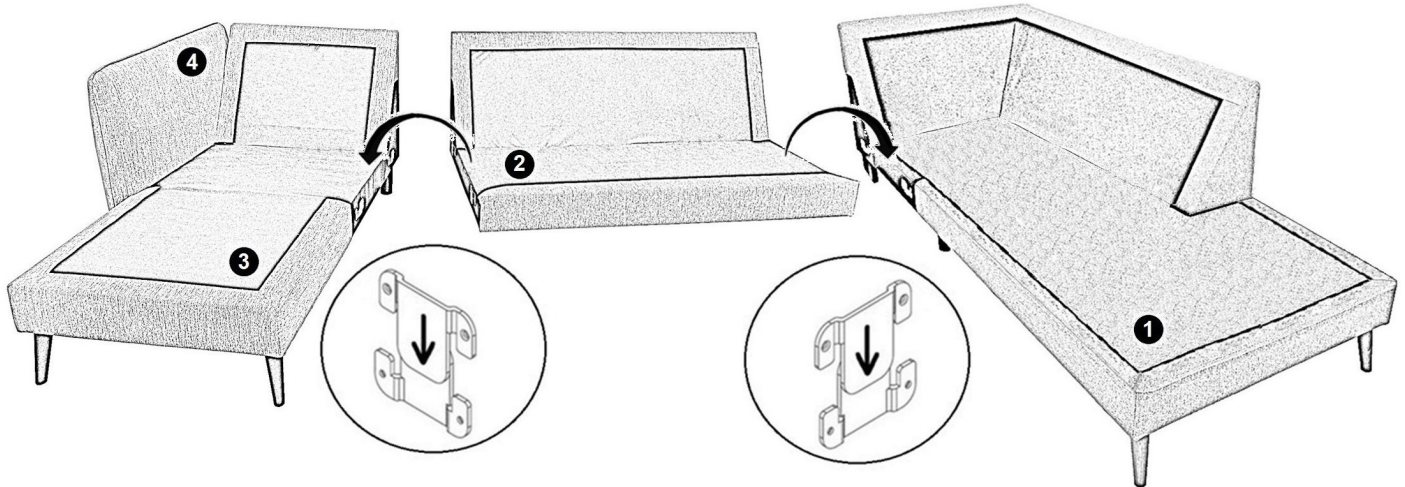

- D Allgemeiner Sicherheitshinweis:**
Nicht mehr benötigte Verpackungsmaterialien und Kleinteile von Kindern fernhalten!
- GB General safety instructions:**
Package material you do not need any more take far away from children.
- F Consigne de sécurité:**
Ecarter les matériaux d'emballage et petites pièces inutiles de la portée des enfants.
- PL Ogólne zasady bezpieczeñstwa:**
Nie potrzebne opakowania i małe części chronić przed dziećmi!
- RU Общие указания по безопасности:**
Неиспользуемые упаковочные материалы и мелкие детали следует хранить в недоступном для детей месте!
- NL Algemene veiligheidsinstructie:**
Verpakkingsmaterialen die u niet meer nodig heeft en kleine onderdelen uit de buurt van kinderen houden!
- TR Genel güvenlik uyarısı:**
Kullanılmayan ambalaj malzemeleri ve küçük parçaları çocuklardan uzak tutun!
- RO Indicațiile generale de siguranță:**
Ambalajele care nu mai sunt necesare și piesele de mici dimensiuni nu vor fi lăsate la îndemâna copiilor!
- IT Indicazioni generali per la sicurezza:**
Tenere lontano da bambini materiali di imballaggio non più necessari e minuscoli!
- SK Všeobecné bezpečnostné upozornenie:**
Nepotrebný baliaci materiál a malé diely uchovávať mimo dosahu detí!
- CZ Všeobecné bezpečnostní upozornění:**
Obalové materiály a malé díly, které už nepotřebujete, udržujte mimo dosah dětí!
- HU Általános biztonsági tudnivaló:**
Ha már nincs szüksége a csomagolóanyagokra és apró darabokra, tegye őket olyan helyre, ahol nem férhetnek hozzá gyermekek!

