

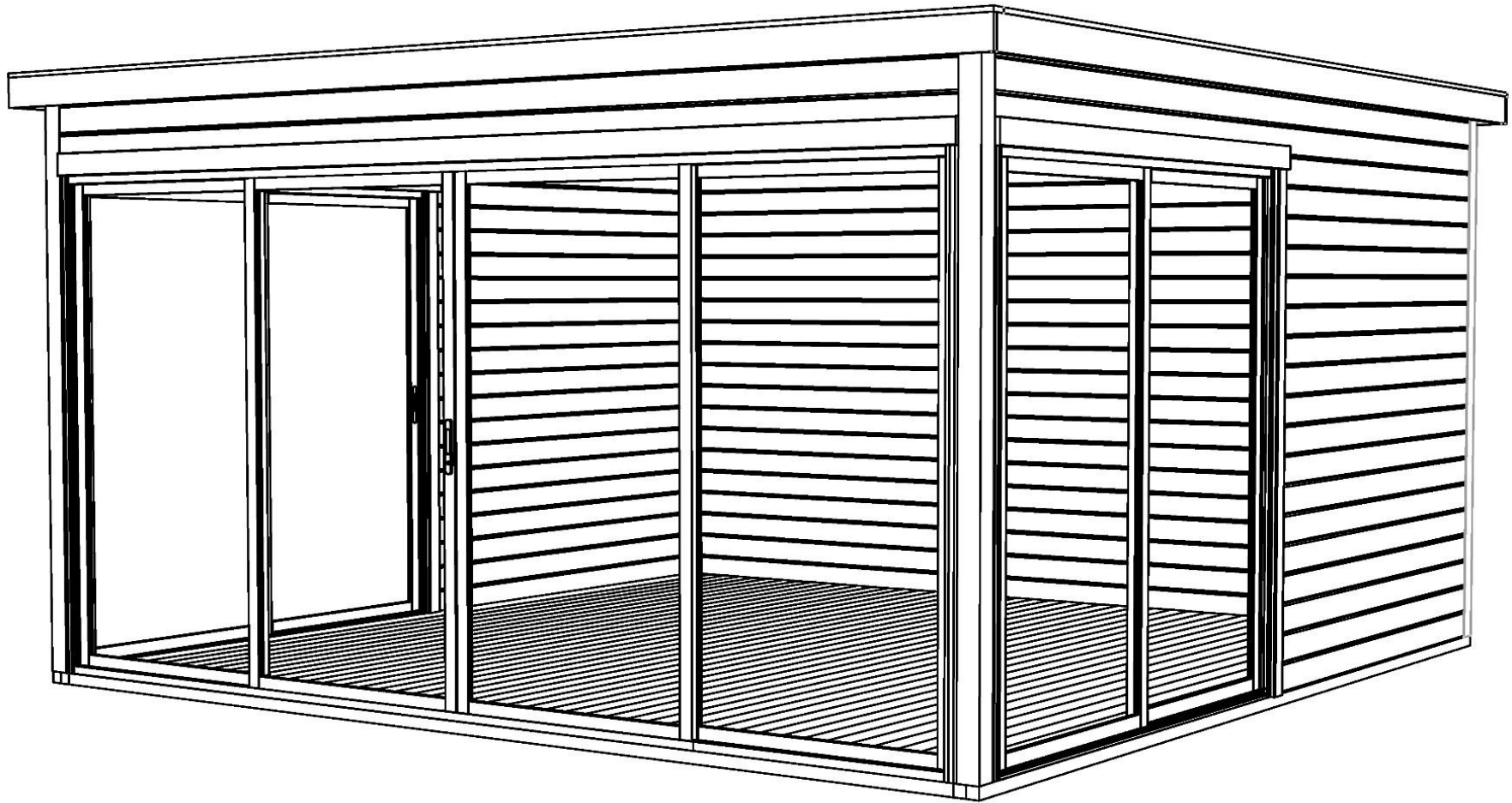

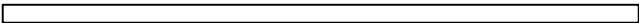







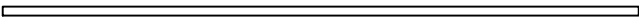

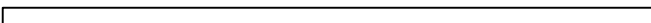
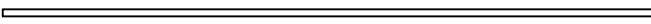
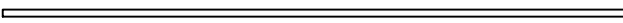

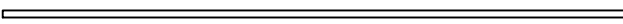
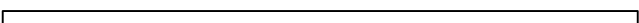





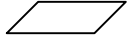

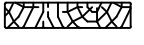
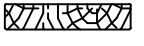
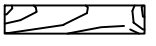
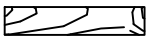

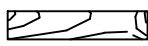
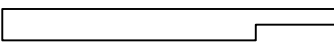

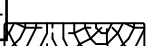
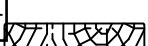









*Domeo 5*  
*Art. Nr. 4424119*  
*1/24*



Pos	11.09.2019	Piece list - Stückliste - Liste des pièces - Elementi - Stuklijst - Tükítabel Art.Nr. 4424119	2/24	Q	P (mm)	L (mm)
001				21	44x114	4092
002				2	44x114	4092
003				1	44x57	4092
004				36	44x114	2026
005				4	44x114	4180
006				2	44x114	4180
IAR1		Foundation - Fundament - Fondation - Fondamenta - Fundering - Immutatud alusraam 		4	45x70	4180
IAR3		Foundation - Fundament - Fondation - Fondamenta - Fundering - Immutatud alusraam 		10	45x70	4000
IAR2		Foundation - Fundament - Fondation - Fondamenta - Fundering - Immutatud alusraam 		2	45x70	100
RV1		Lath - Pfetten - Liteau - Piccola asse - Gordingen - Roov 		1	44x44	4000
A-PR1		Roof beam - Dachbalken - Panne de toit - Perlina del tetto - Gordingen / dakbalk - Pärlin 		5	70x140	4084
FB		Floor boards - Fussbodenbretter - Lame de plancher - Pavimento - Vloerhout - Põrandataud 		46	90x18	4072
DB		Roof boards - Dachbretter - Voliges - Perlina per tetto - Dakhout - Katuselaud 		46	90x18	4200
		Floor fillet - Fussbodenteiste - Corniere de finition du plancher - Finitura per pavimento (battisco pa) - Vloerafwerkljst - Põrandaliist 			18x18	16.32
DPL1		Roofing felt fillet - Dachpappenleiste - Baquette de fixation du feutre bitumeux - Asse per fissaggio guaina bituminosa - Afdeklijt asfaltpapier - Katusepapiiliist 		2	18x58	4318
DPL2		Roofing felt fillet - Dachpappenleiste - Baquette de fixation du feutre bitumeux - Asse per fissaggio guaina bituminosa - Afdeklijt asfaltpapier - Katusepapiiliist 		1	18x58	4376
TP1		Diagonal support batten - Hilfsleiste - Tasseau - Listelli per rinforzare - Timmerhout - Tugitaud 		4	18x90	350
TP2		Diagonal support batten - Hilfsleiste - Tasseau - Listelli per rinforzare - Timmerhout - Tugitaud 		8	18x90	1200
RS2		Railing strip - Begrenzungsleiste - Rembarde - Sbarra - Afscheidingslijst - Piirdetaud 		2	18x70	1982
RS4		Railing strip - Begrenzungsleiste - Rembarde - Sbarra - Afscheidingslijst - Piirdetaud 		2	18x70	2000
RS7		Railing strip - Begrenzungsleiste - Rembarde - Sbarra - Afscheidingslijst - Piirdetaud 		2	18x90	2116
RS8		Railing strip - Begrenzungsleiste - Rembarde - Sbarra - Afscheidingslijst - Piirdetaud 		2	18x90	2126
RS9		Railing strip - Begrenzungsleiste - Rembarde - Sbarra - Afscheidingslijst - Piirdetaud 		1	18x90	4000

Pos	11.09.2019	Piece list - Stückliste - Liste des pièces - Elementi - Stuklijst - Tükítabel Art.Nr. 4424119	B/24	Q	P (mm)	L (mm)
RS10		Railing strip - Begrenzungsleiste - Rembarde - Sbarra - Afscheidingslijst - Päärdetaud		1	18x90	4020
P1		Post - Pfosten - Poteau - Piede registrabile - Stijl - Post		2	88x88	2330
P2		Post - Pfosten - Poteau - Piede registrabile - Stijl - Post		2	44x44	2260
P3		Post - Pfosten - Poteau - Piede registrabile - Stijl - Post		2	90x90	2220
GL2		Fascia board - Traufbrett - Bandeau de toit - Finitura lati tetto - Gevellijst - Räästataud		2	18x120	4340
GL1		Fascia board - Traufbrett - Bandeau de toit - Finitura lati tetto - Gevellijst - Räästataud		2	18x120	4376
DRV-1		Roof edge reinforcement - Dachrandverstärkung - Corniere de renfort de bord de toit - Rinforzo x tetto - Dakrand versterking - Räästafugevdus		2	80x44	4180
DRV-2		Roof edge reinforcement - Dachrandverstärkung - Corniere de renfort de bord de toit - Rinforzo x tetto - Dakrand versterking - Räästafugevdus		2	80x44	4340
FF2		Fixing fillet - Fixierungsleiste - Profil de fixation - Massello di fissaggio - Bevestiging lijstwerk - Tenderliist		4	15x45	2025
FF		Fixing fillet - Fixierungsleiste - Profil de fixation - Massello di fissaggio - Bevestiging lijstwerk - Tenderliist		2	18x44	2030
FF3		Fixing fillet - Fixierungsleiste - Profil de fixation - Massello di fissaggio - Bevestiging lijstwerk - Tenderliist		2	38x46	1980
FF4		Fixing fillet - Fixierungsleiste - Profil de fixation - Massello di fissaggio - Bevestiging lijstwerk - Tenderliist		2	38x46	2026
FF5		Fixing fillet - Fixierungsleiste - Profil de fixation - Massello di fissaggio - Bevestiging lijstwerk - Tenderliist		1	38x46	3960
HS32		Screw for door jamb - Schraube für Türrahmen - Vis de fixation partie haute avec montants du cadre de porte - Viti x fissaggio montanti porte - Schroef voor deurkozijn - Kruvi ukse lengile		8	4x25	
HS14		Screw for wall details - Schraube für wand details - Vis pour mur details - Viti per elementi della porta - Schroef voor wand details - Kruvi seinte montaaziks		300	4.5x80	
HS12		Screw for doorstep - Schrauben für swelle - Vis pour fixation barre de seuil - Vite per soglia della porta - Schroef voor deurdorpel - Kruvi lävepakute		12	4x40	
HS12		Screw for metal corner - Holzschraube für metallwinkel - Vis de fixation des cornieres en métal - Viti per fissare quadretta di metallo di giunzione - Schroef voor metalen hoek - Kruvi nurgikute		40	4x40	
HS12		Screw for covering moulding - Schrauben für deckungsprofil - Vis de fixation profils horizontaux haut intérieur et extérieur d'encadrement de porte - Vite per cornice di copertura - Schroef voor afdekprofiel - Kruvi piirdetaude		58	4x40	
HS12		Screw for diagonal support batten - Schraube für dachlatte - Vis de tasseau - Vite per listelli per rinforzare - Schroef voor timmerhout - Kruvi tugilauate		16	4x40	
HS12		Screw for fascia boards - Schrauben für traufbretter - Vis pour fixation bandeau de toit - Viti x striscia del tetto - Schroef voor gevellijst - Kruvi räästataude		36	4x40	
HS12		Screw for beam holder - Schrauben für balkenhalter - Vis de fixation support "u" galvanisé - Vite per trave di sostegno - Schroef voor bevestiging balkhouder (gordingschoen) - Kruvi talakingate		120	4x40	
HS12		Screw for fixing fillet of door and window - Schrauben für fixierungsleiste - Vis pour profil vertical de fixation pour ouvertures des fenetres et portes - Viti per massello di fissaggio - Schroeven voor bevestiging van deur en raam lijsten - Kruvi tenderliistudele		36	4x40	
HS12		Screw for diagonal support batten - Schraube für dachlatte - Vis de tasseau - Vite per listelli per rinforzare - Schroef voor timmerhout - Kruvi tugilauate		24	4x40	



Groundplan - Grundplan - Plan de masse - Planimetria -  
Plattegrond - Põhiptaan

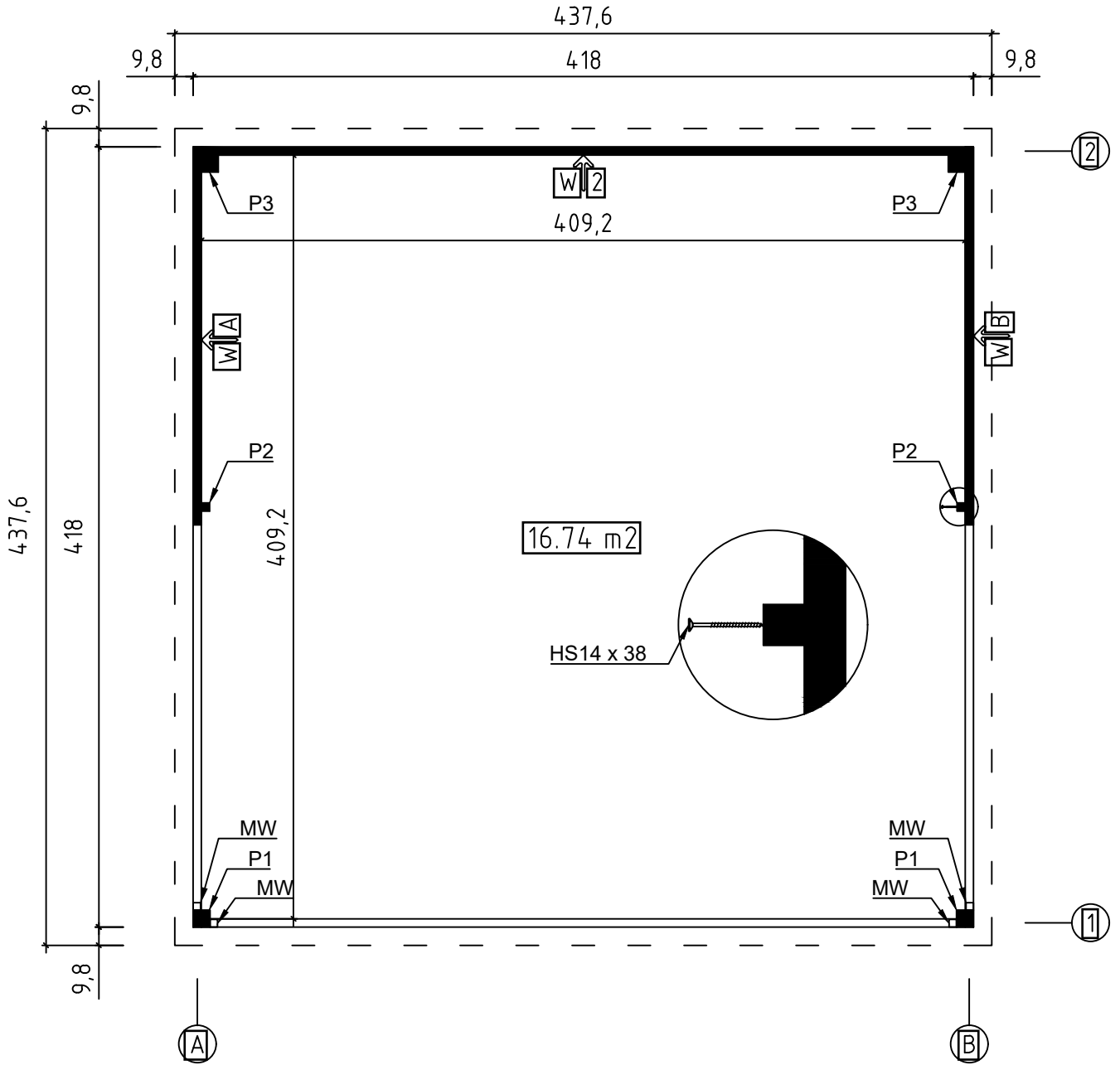

Art.Nr. 4424119

Foundation - Fundament - Fondation - Fundamenta -  
Fundering - Immutatud alusraam

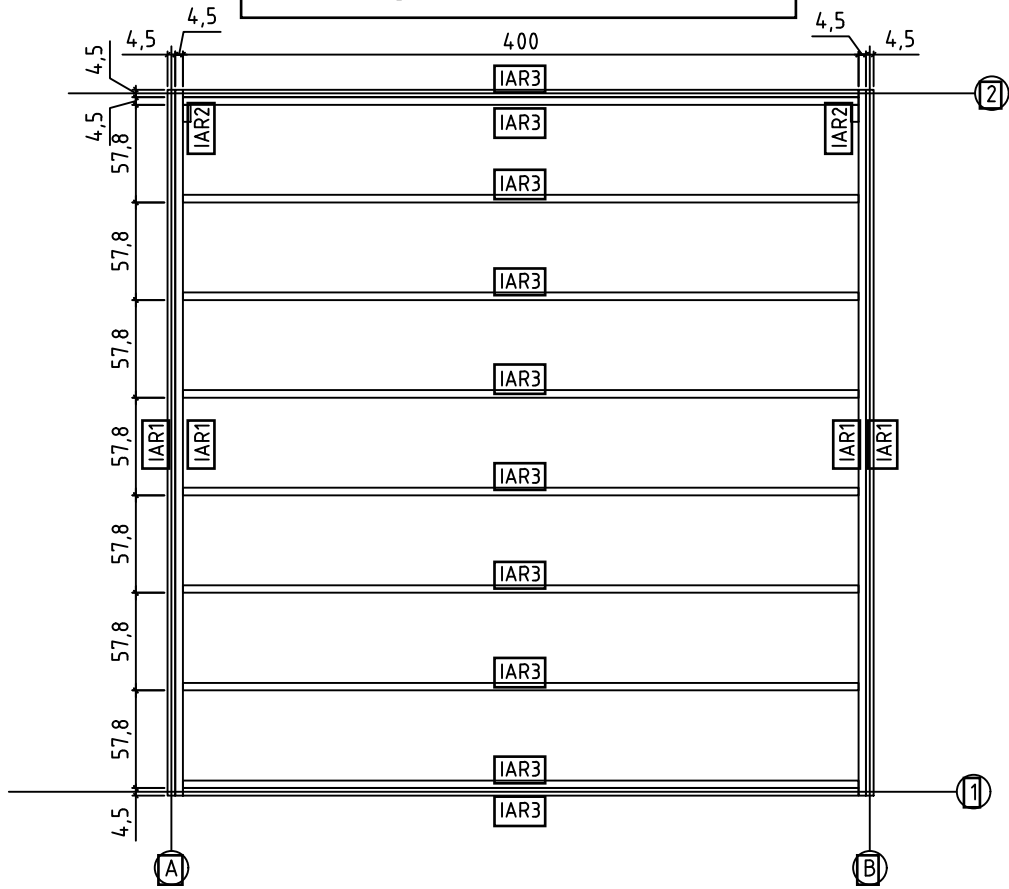

Floor boards - Fussbodenbretter - Plan pose  
plancher - Pavimento - Vloerhout - Põrandataudis

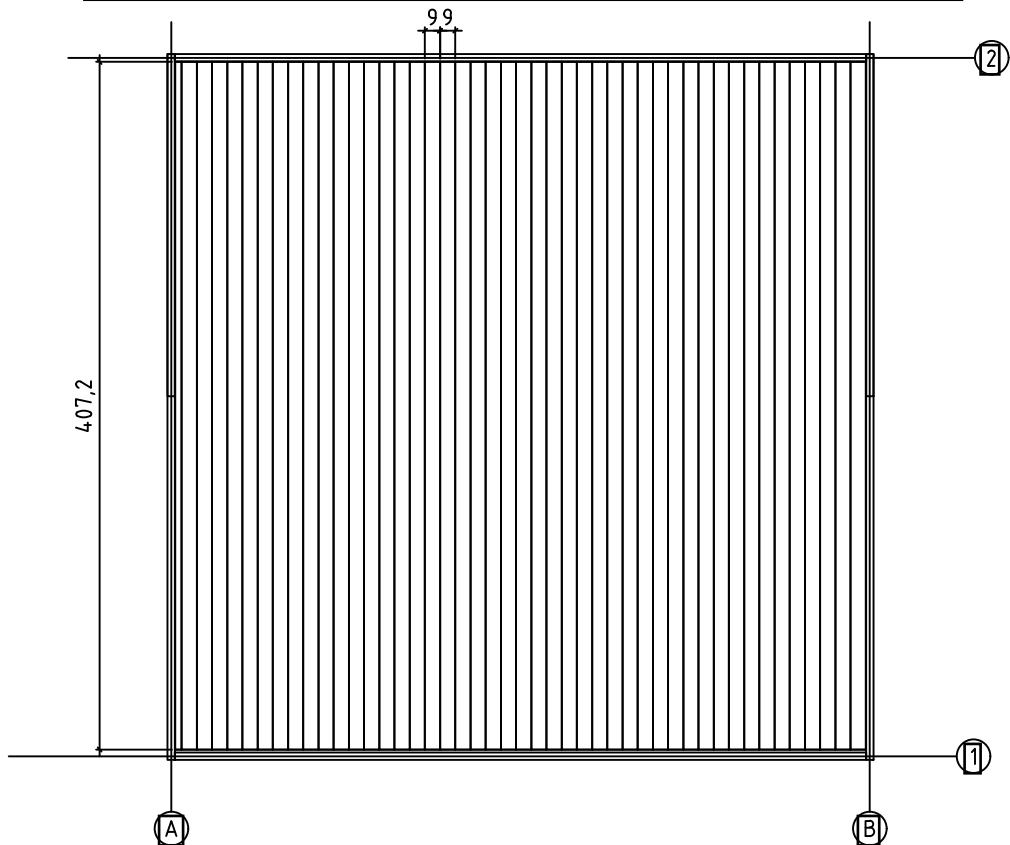

11.09.2019

6/24

Art.Nr. 4424119

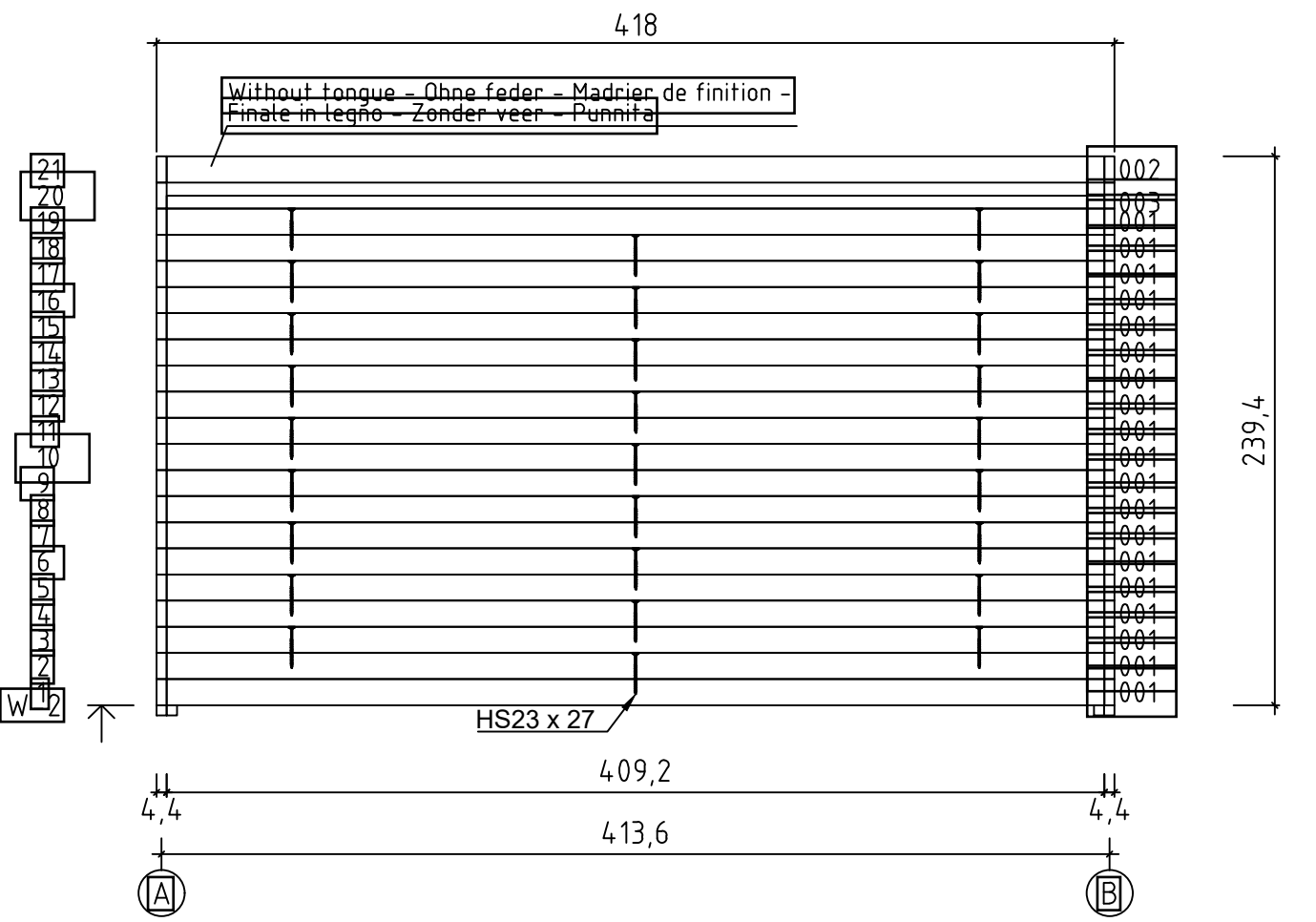
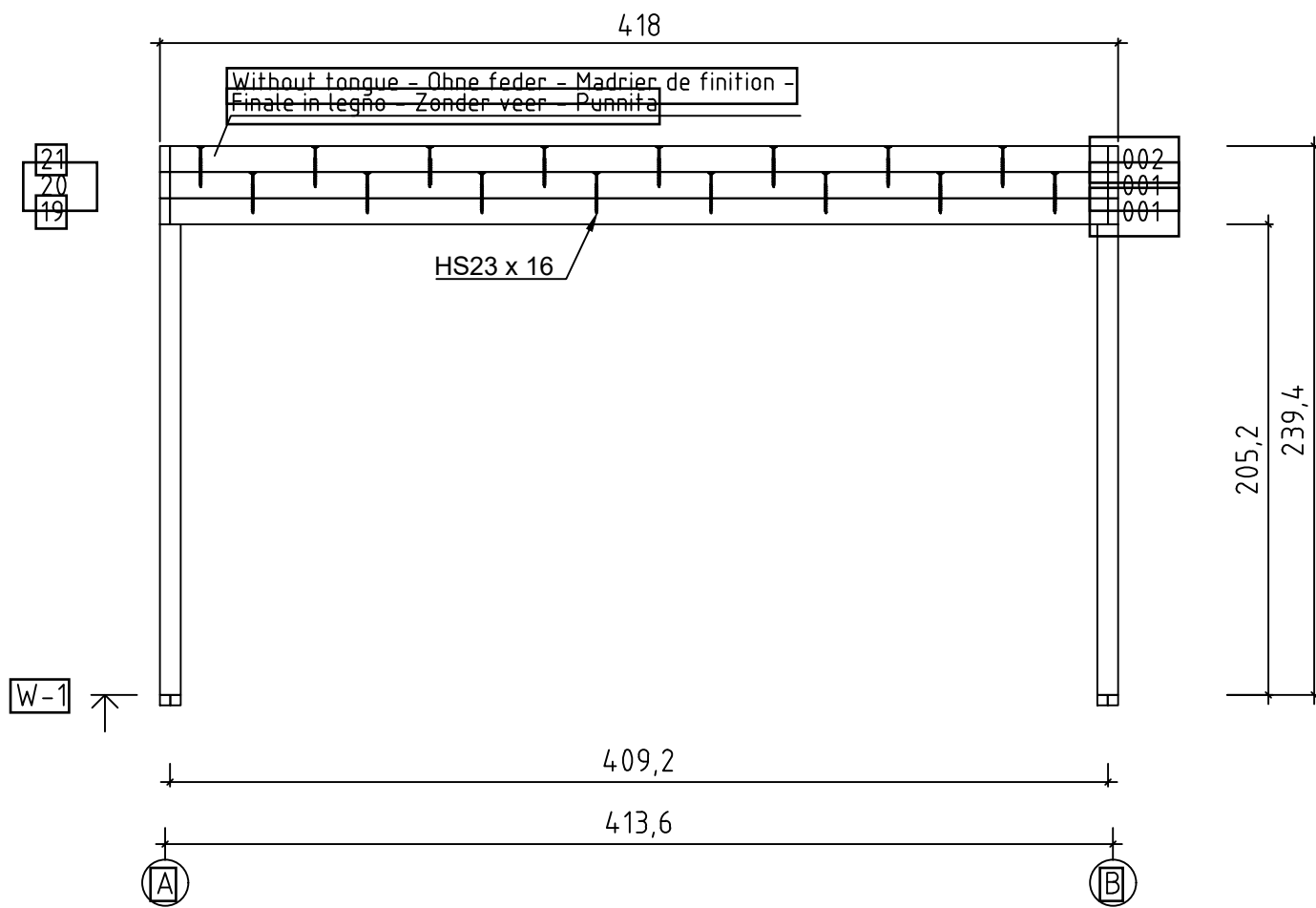

11.09.2019

7/24

Art.Nr. 4424119

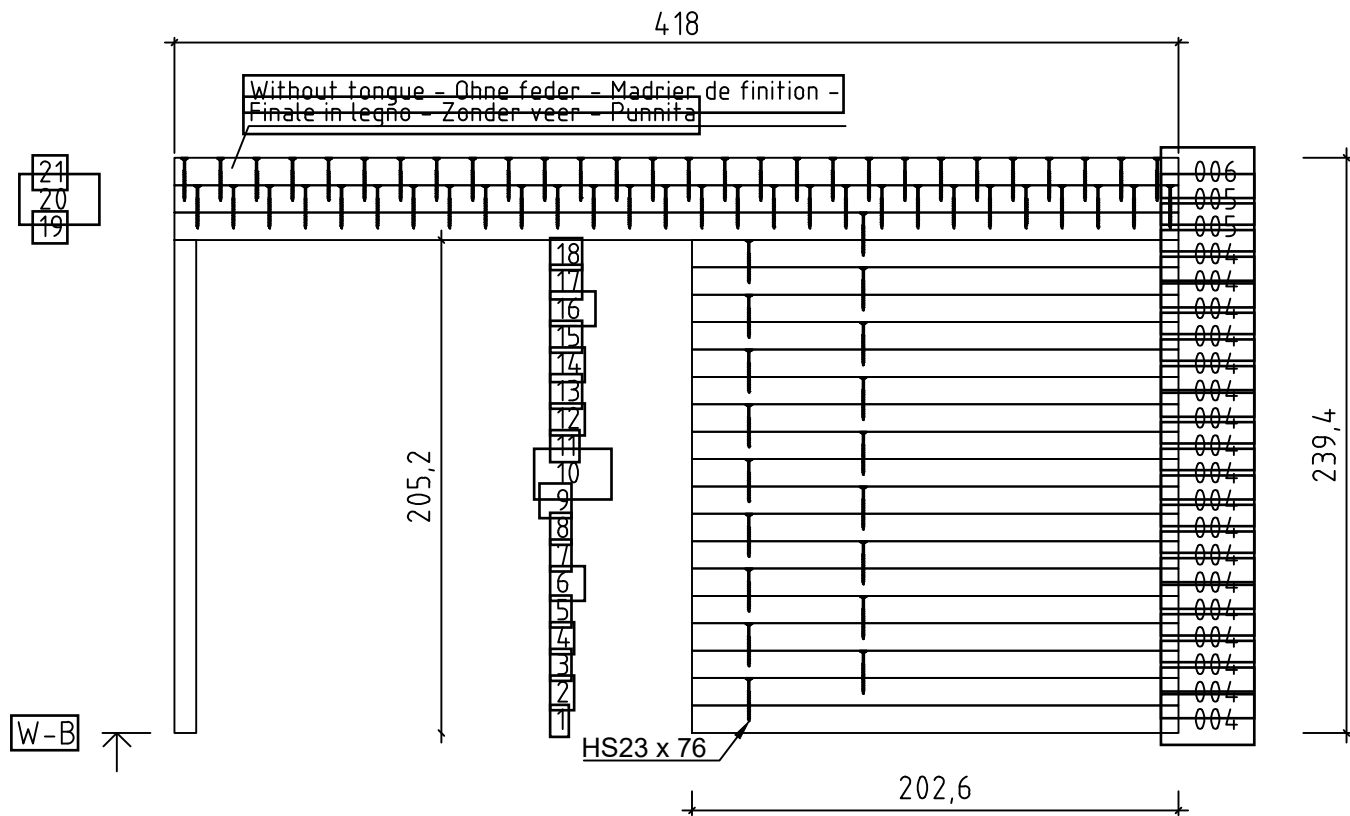
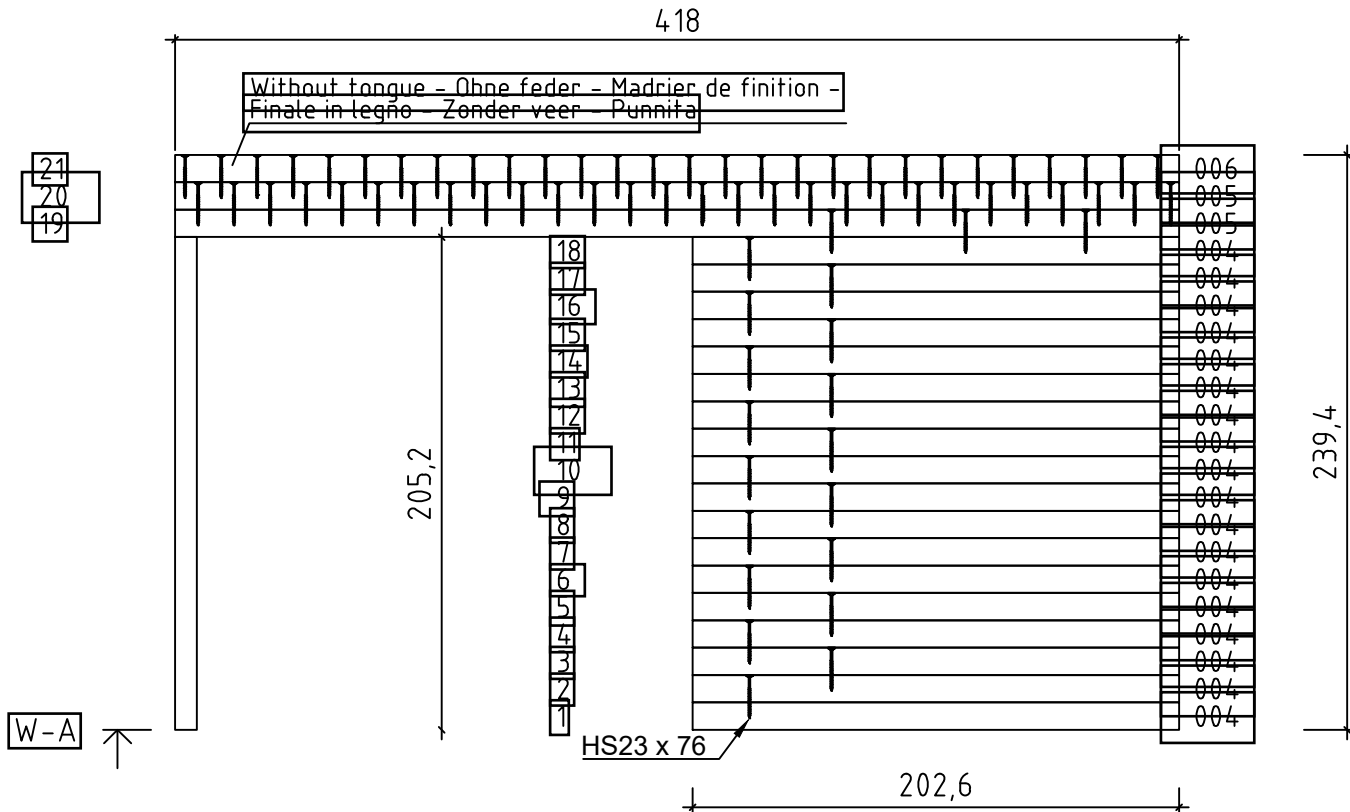



Art. Nr. 4424119

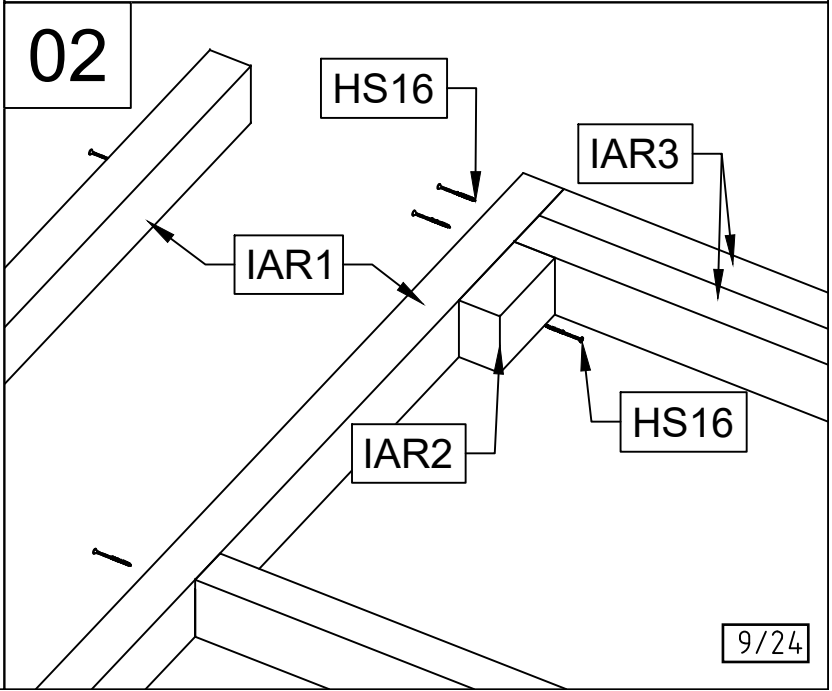
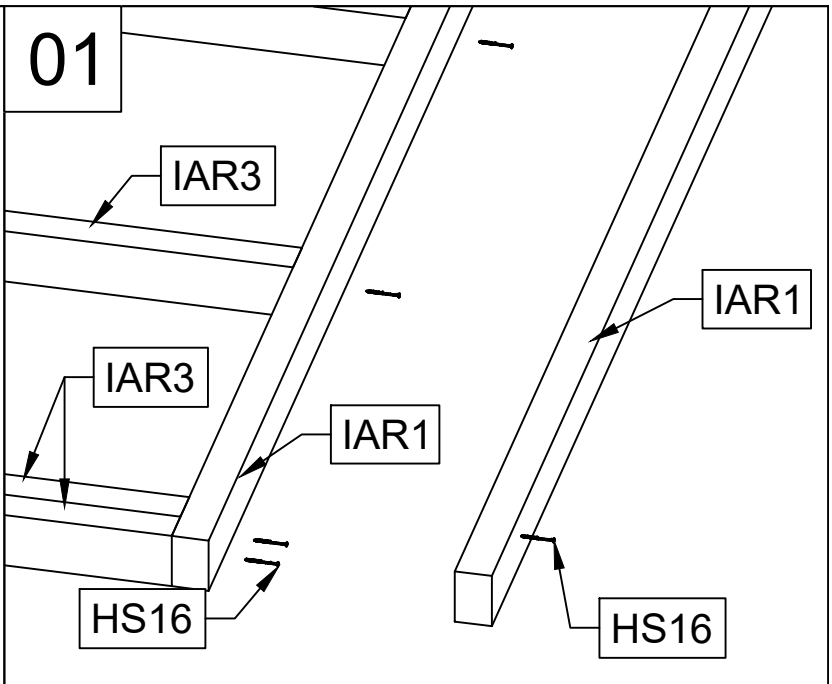
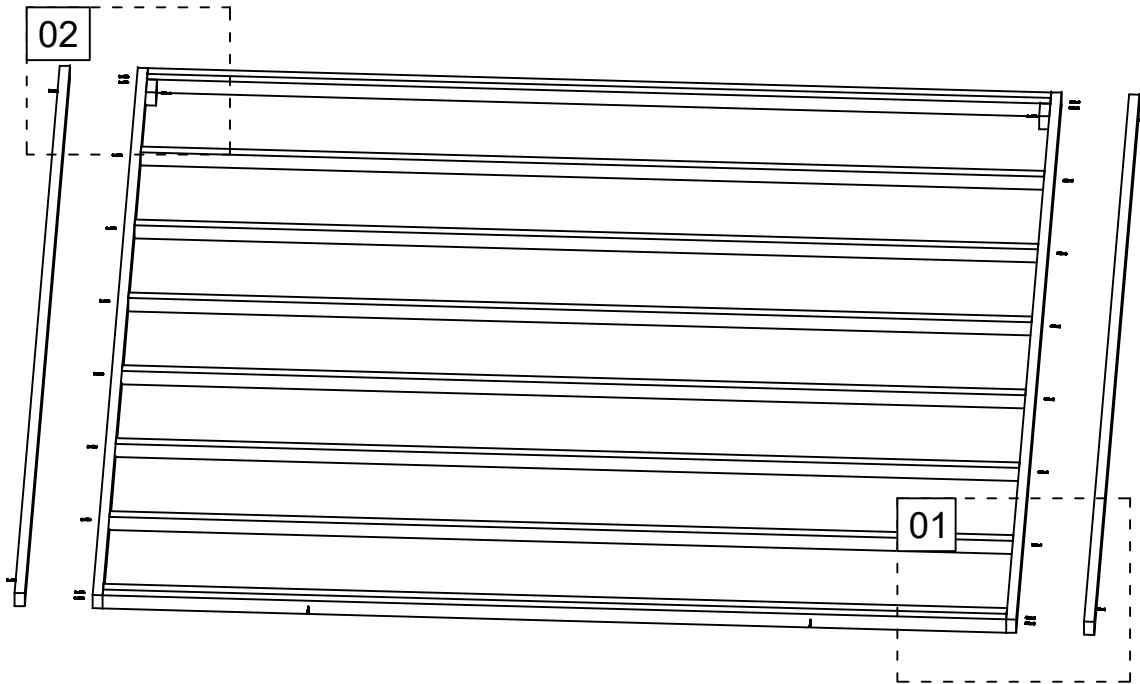

11.09.2019

9/24

Art. Nr. 4424119

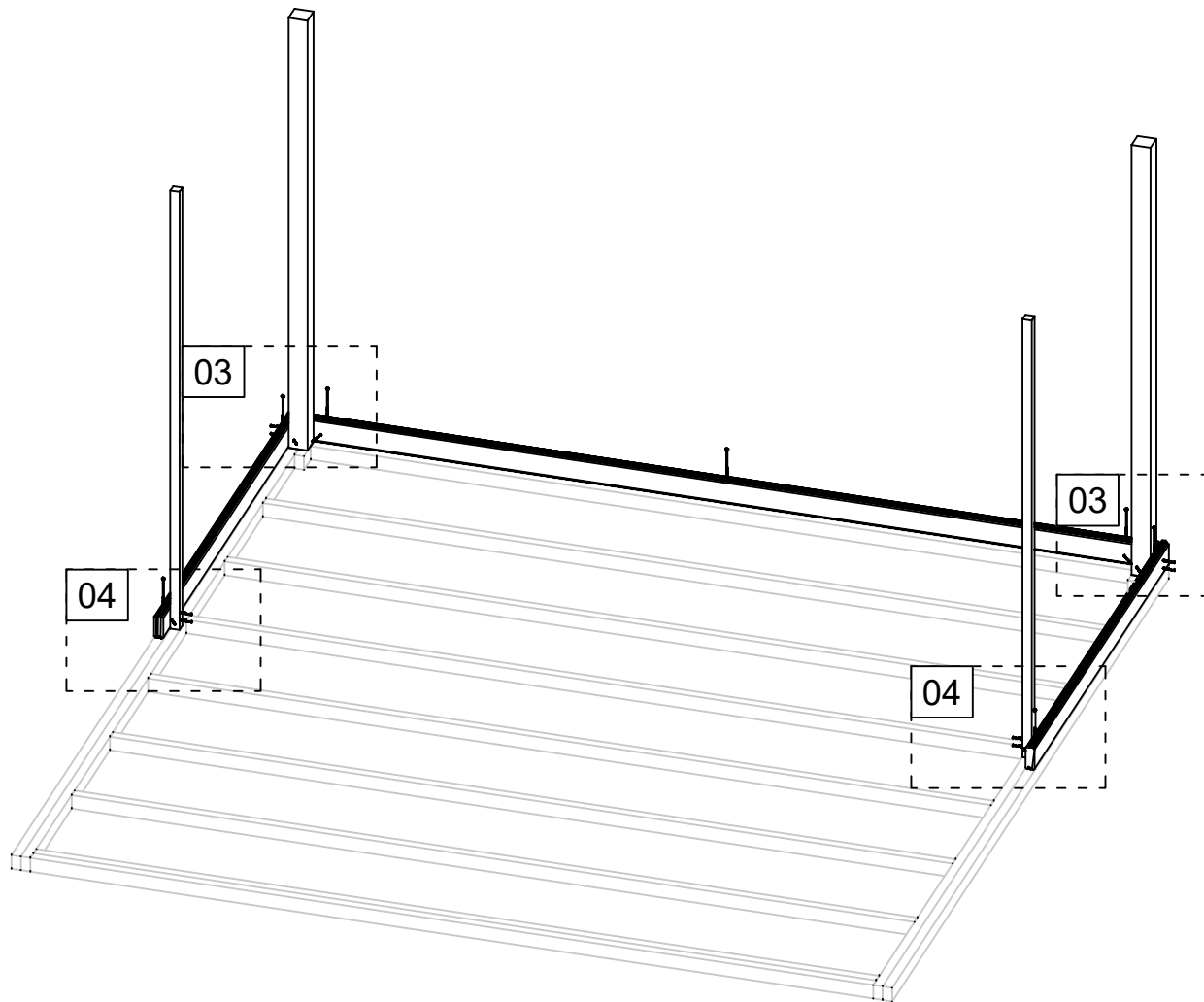

11.09.2019

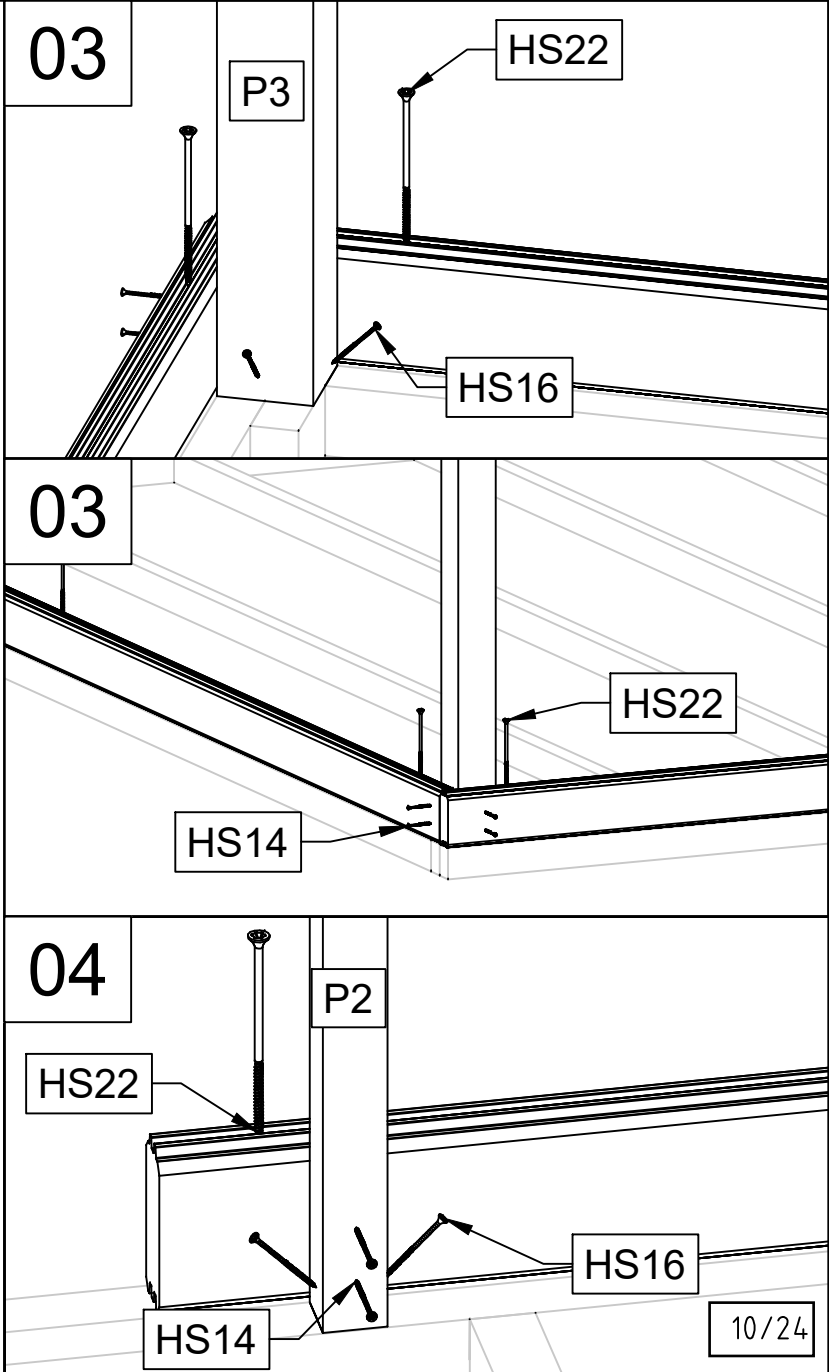

10/24

Art. Nr. 4424119

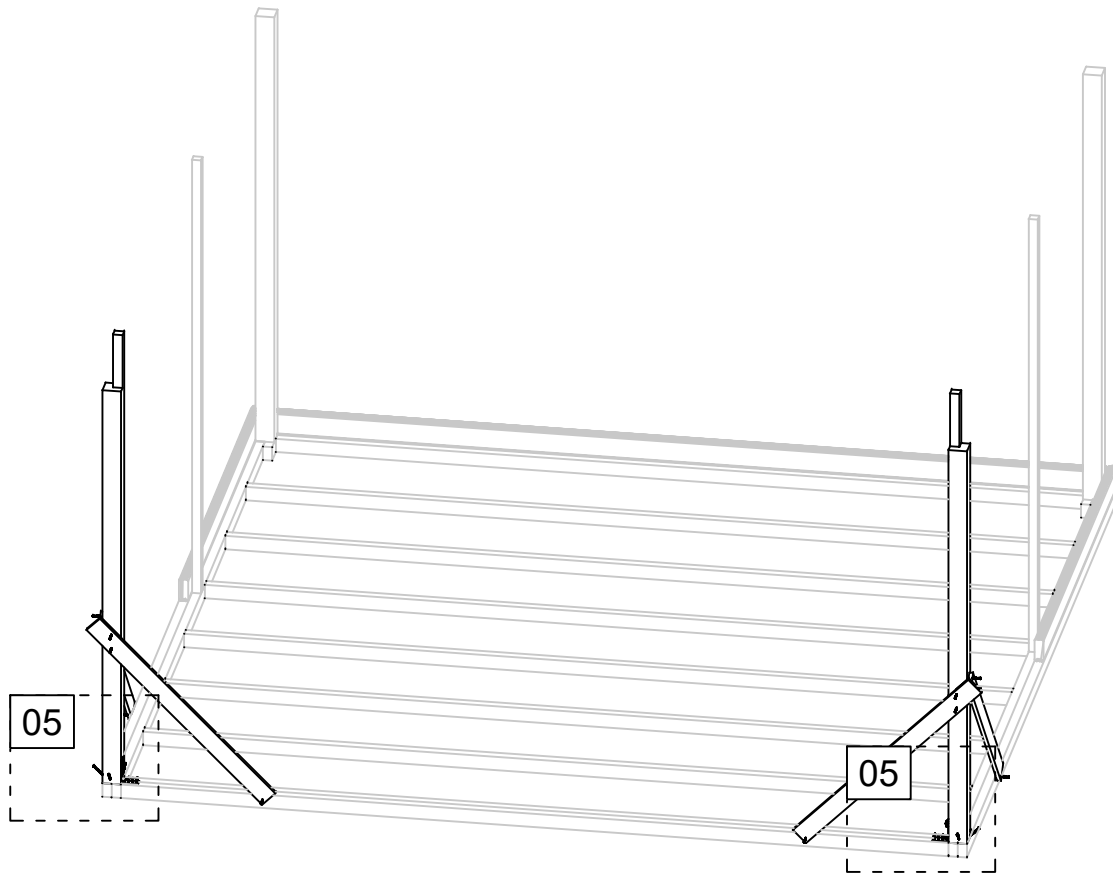

05

TP2

HS12

90°

90°

HS16

05

MW

HS12  
10 pcs.

11.09.2019

11/24

Art. Nr. 4424119

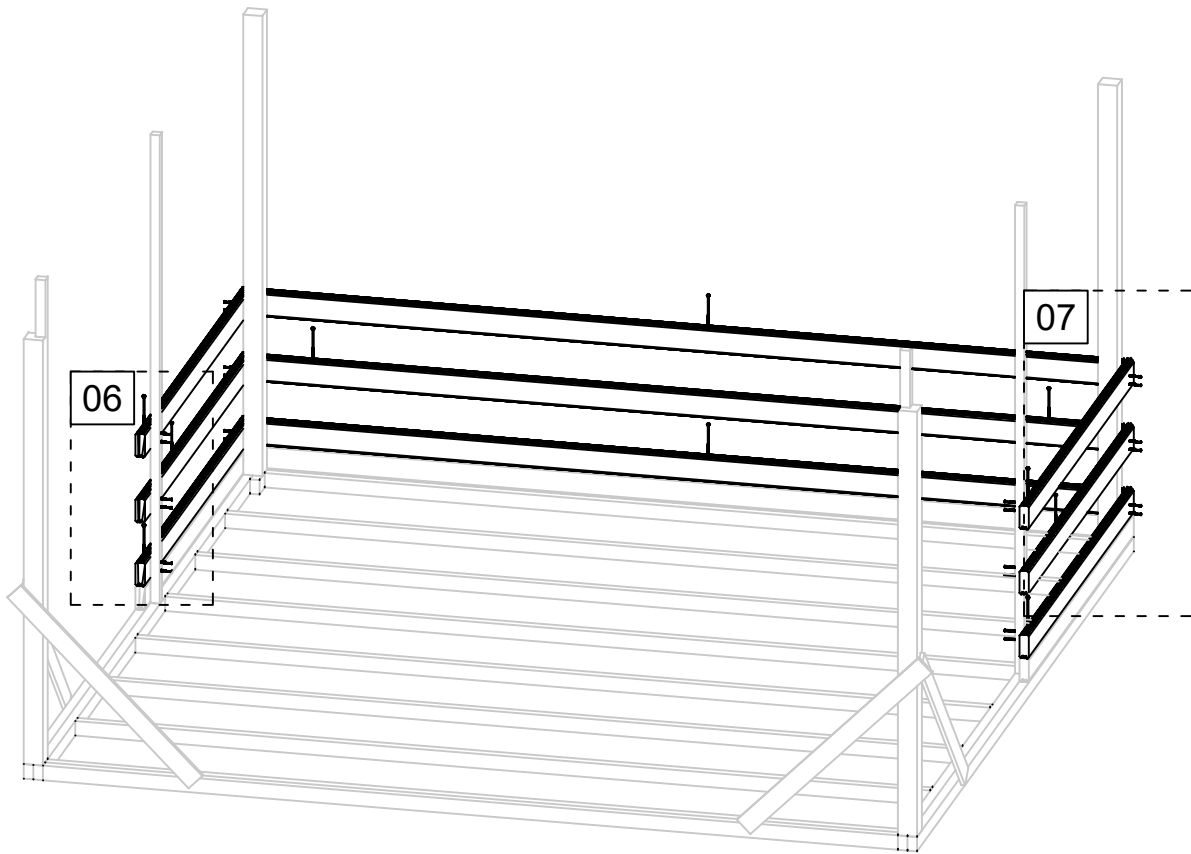

06

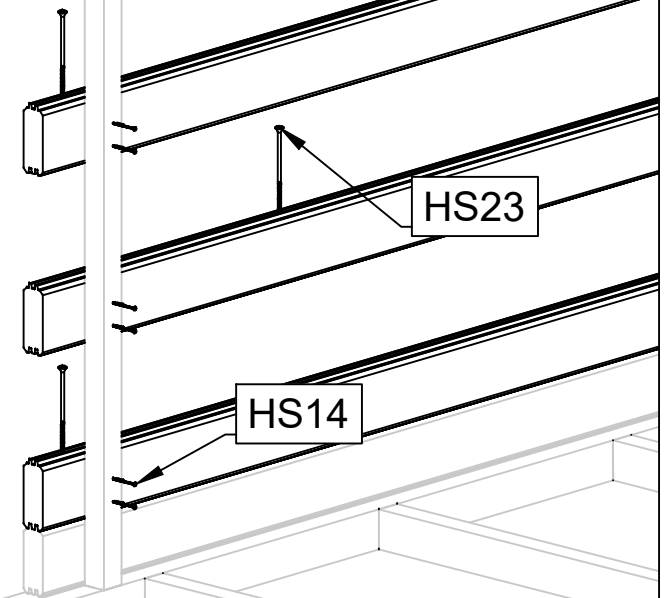

07

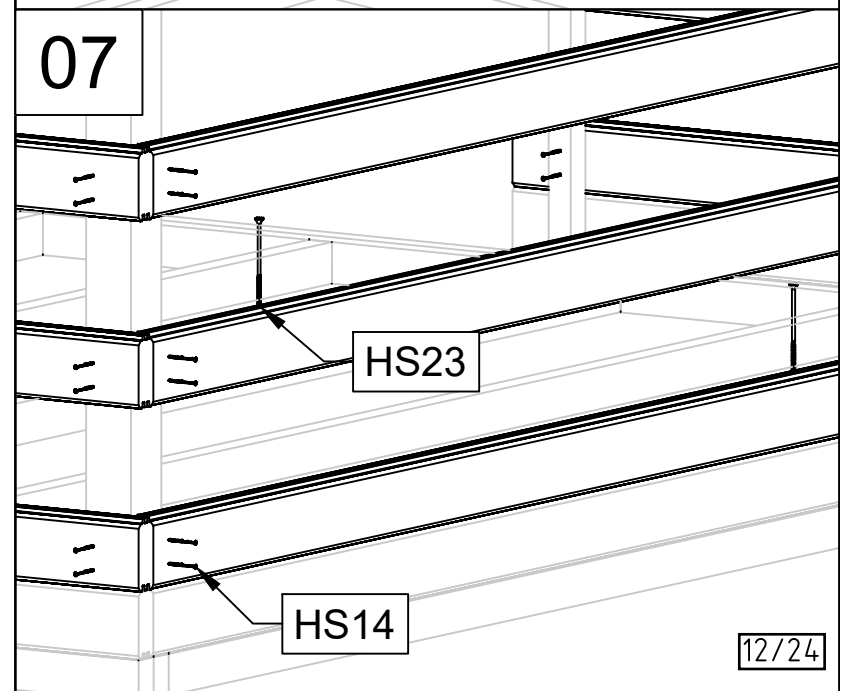

11.09.2019

12/24

Art. Nr. 4424119

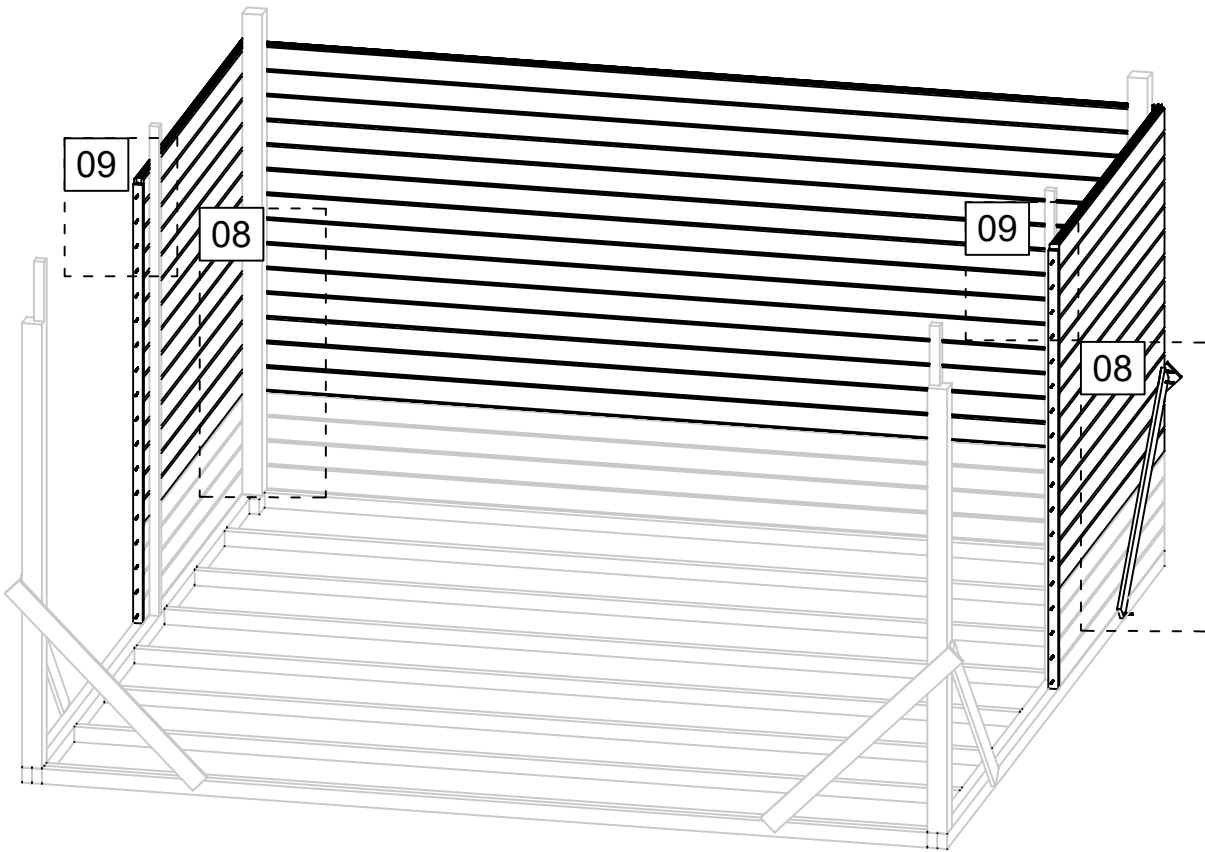

08

TP2

HS12

90°

90°

09

HS12

FF

11.09.2019

13/24

Art. Nr. 4424119

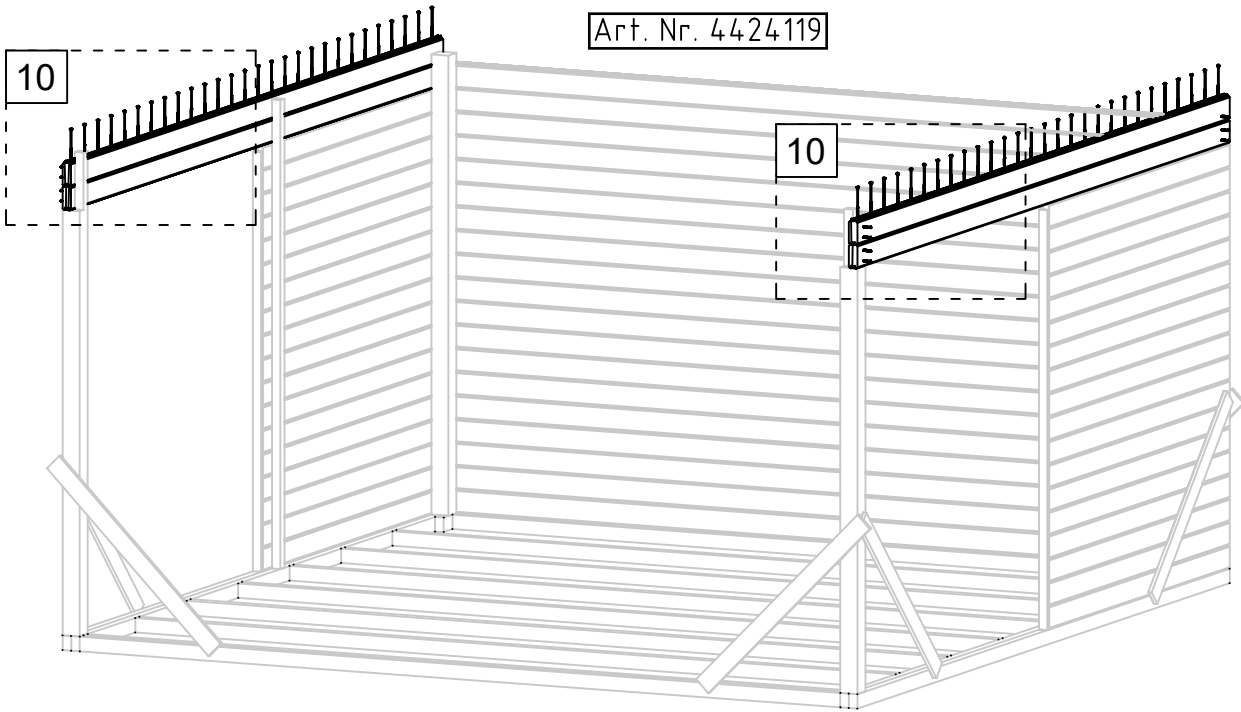

10

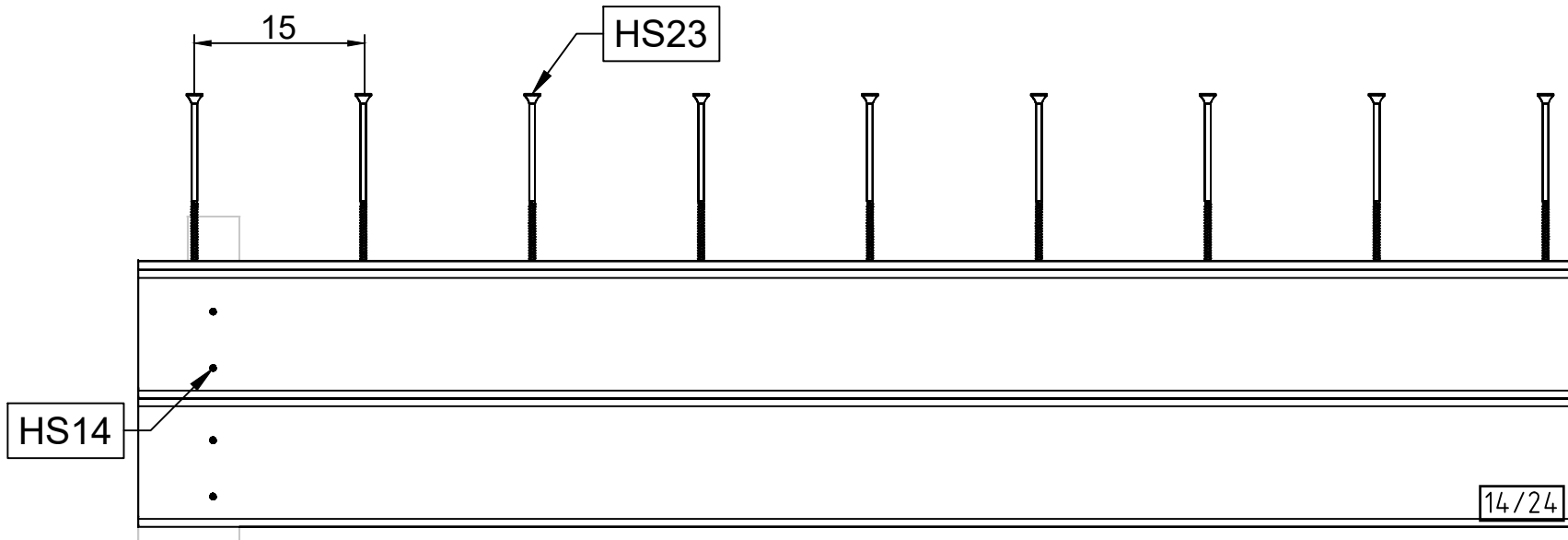

11.09.2019

14/24

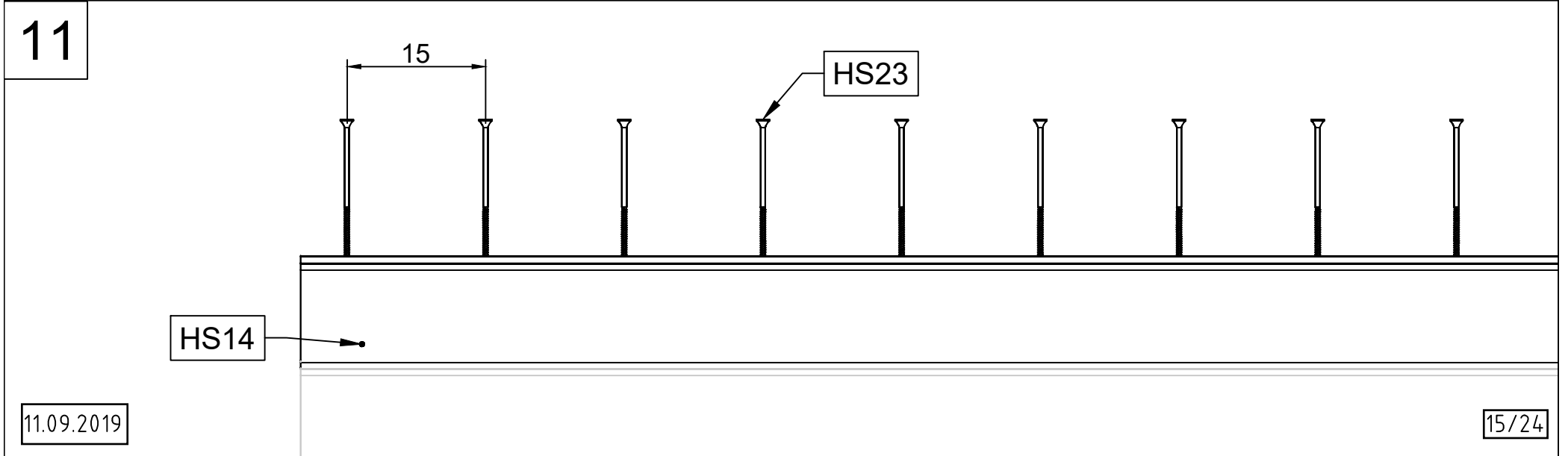
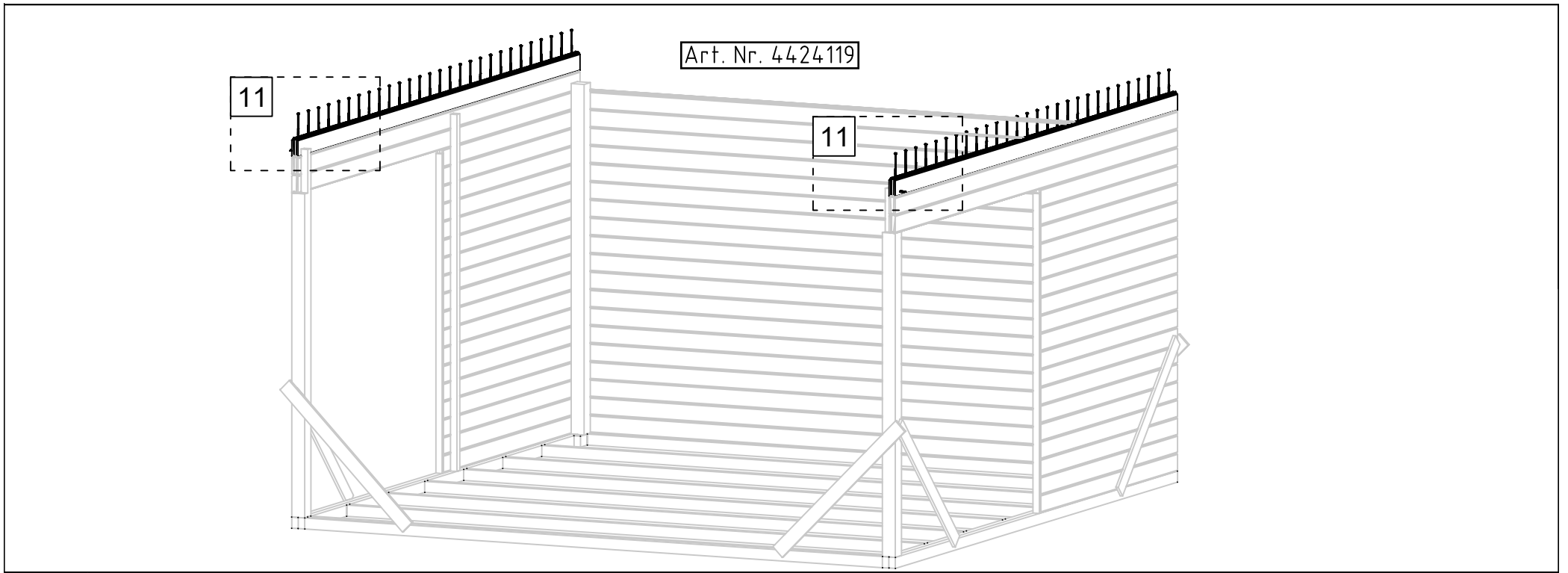

Art. Nr. 4424119

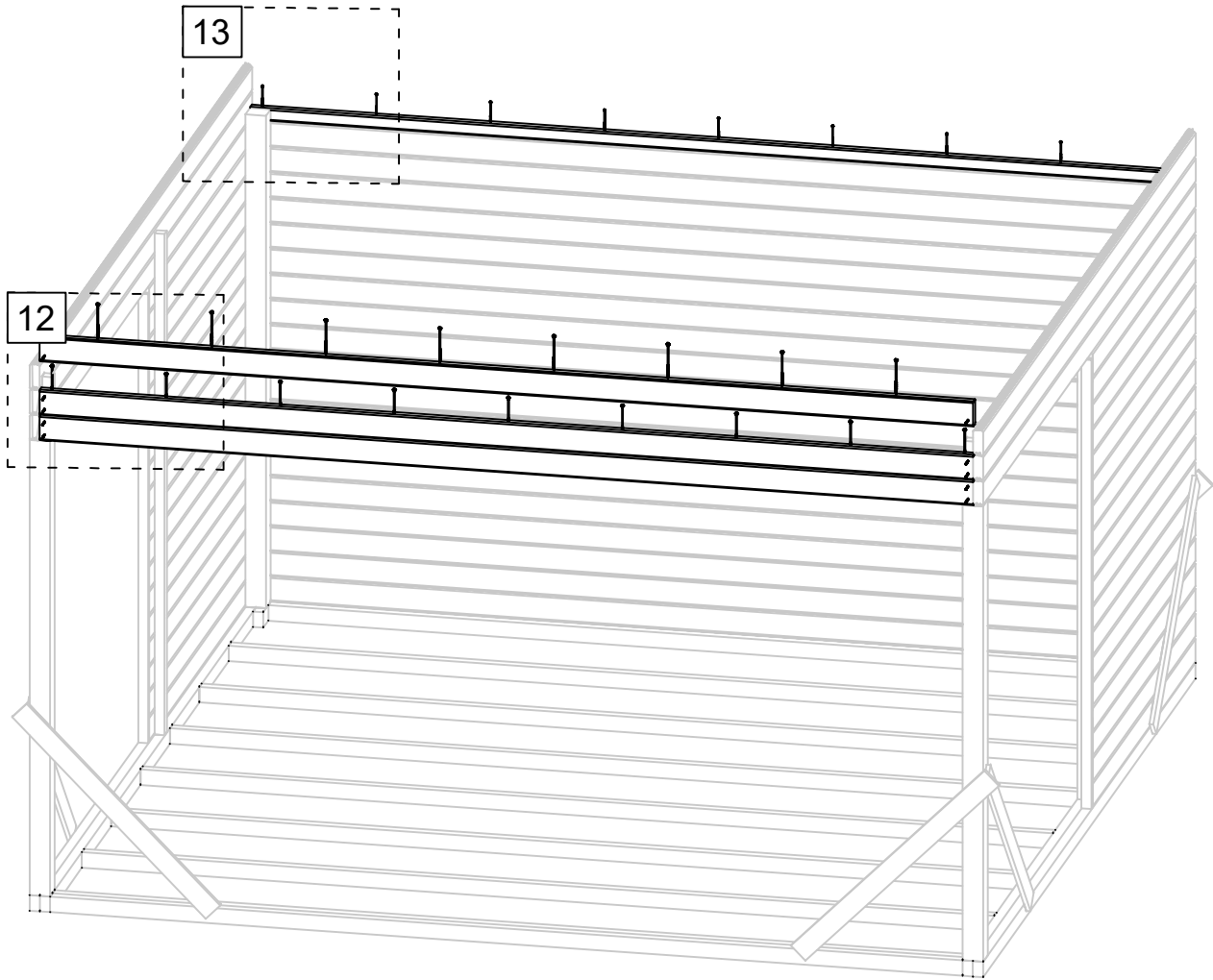

12

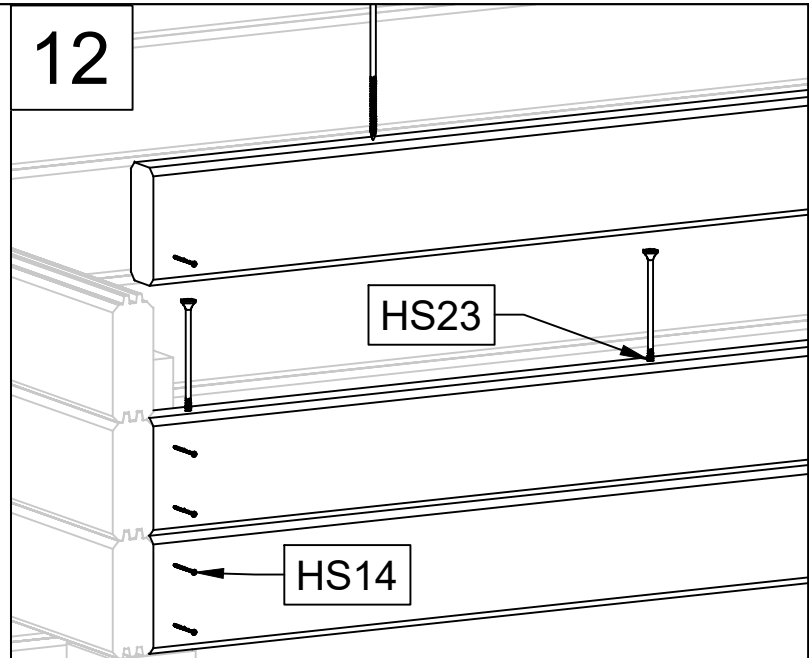

13

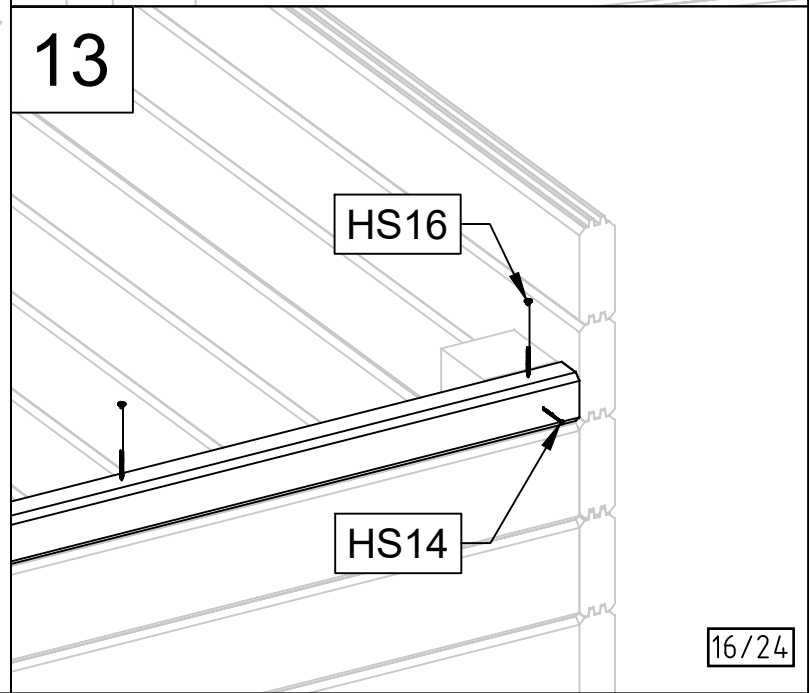

11.09.2019

16/24



Art. Nr. 4424119

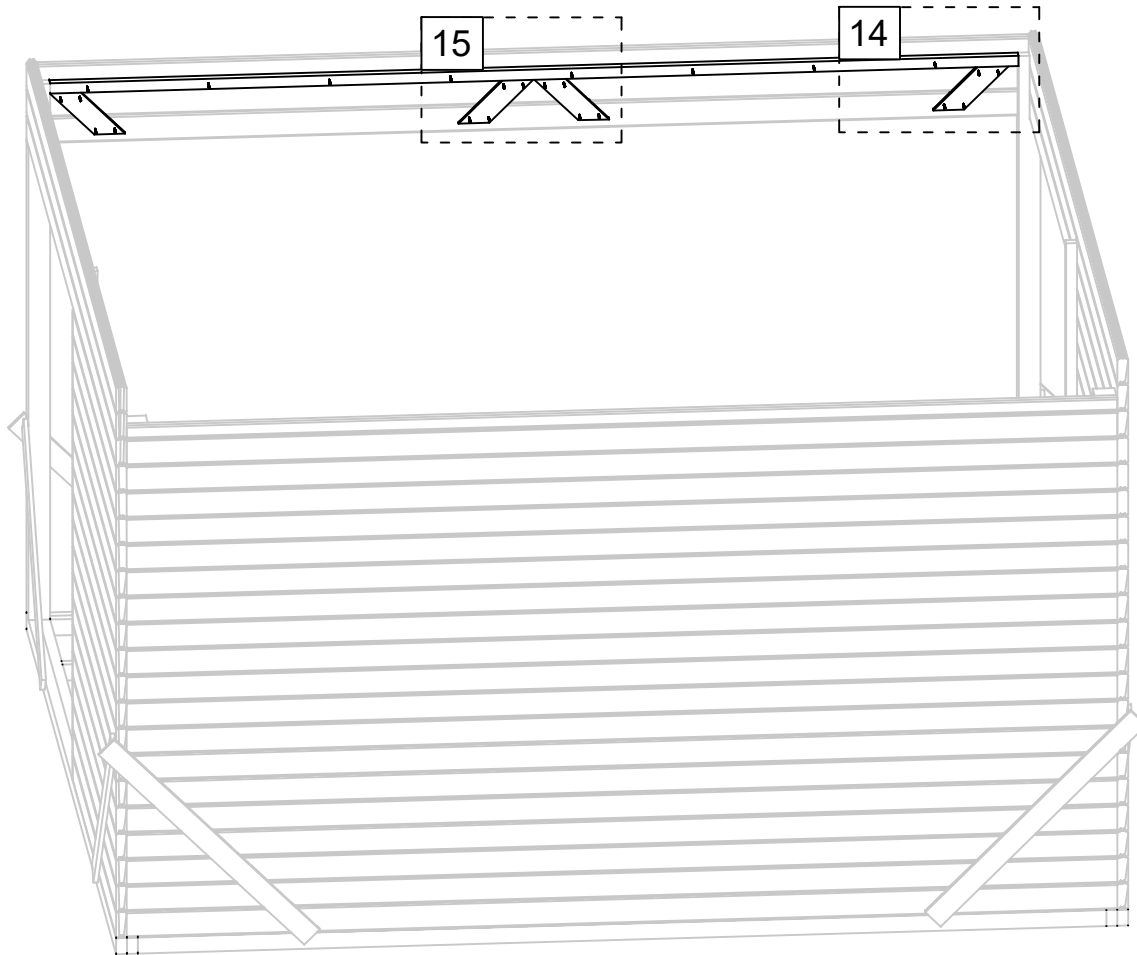

11.09.2019

14

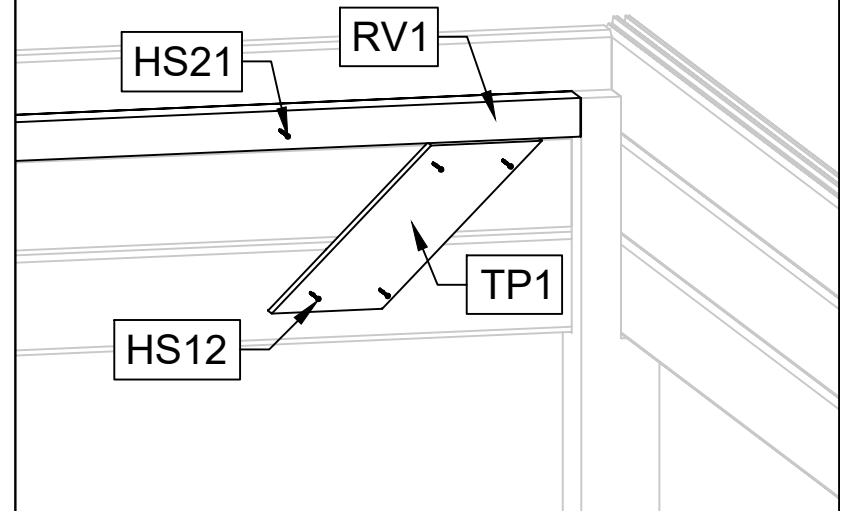

15

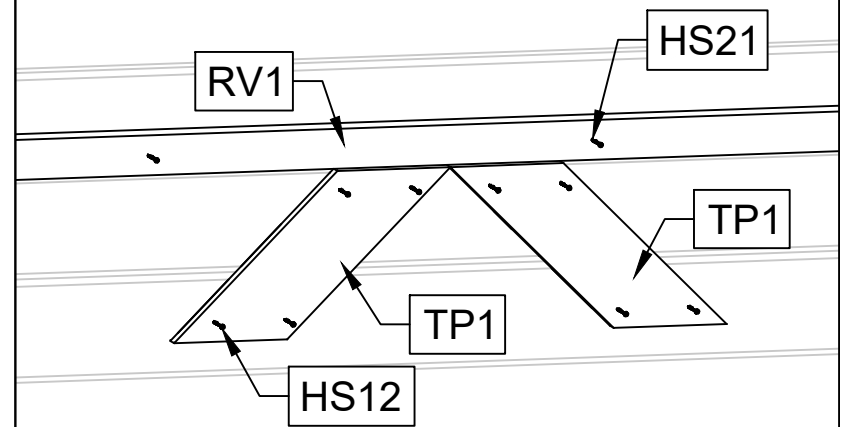

17/24

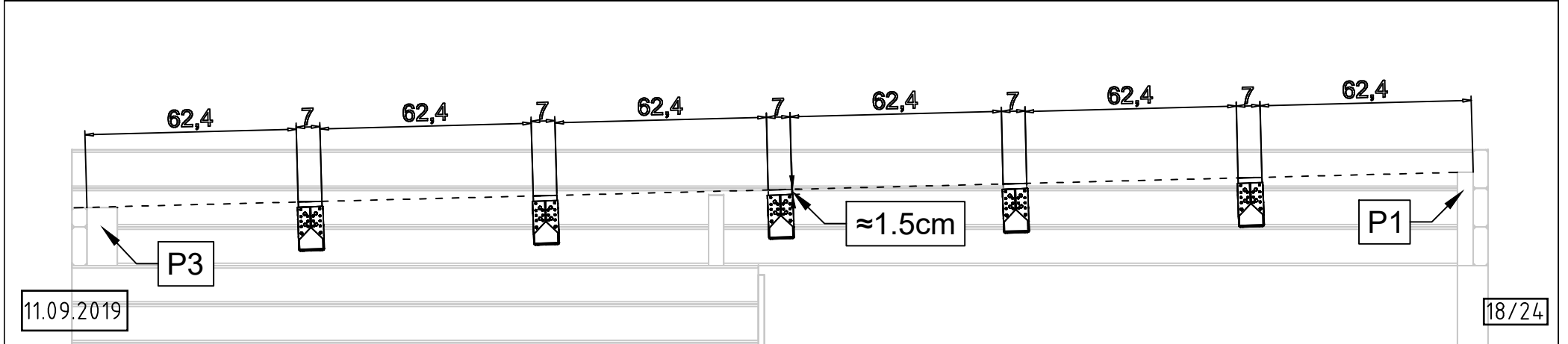
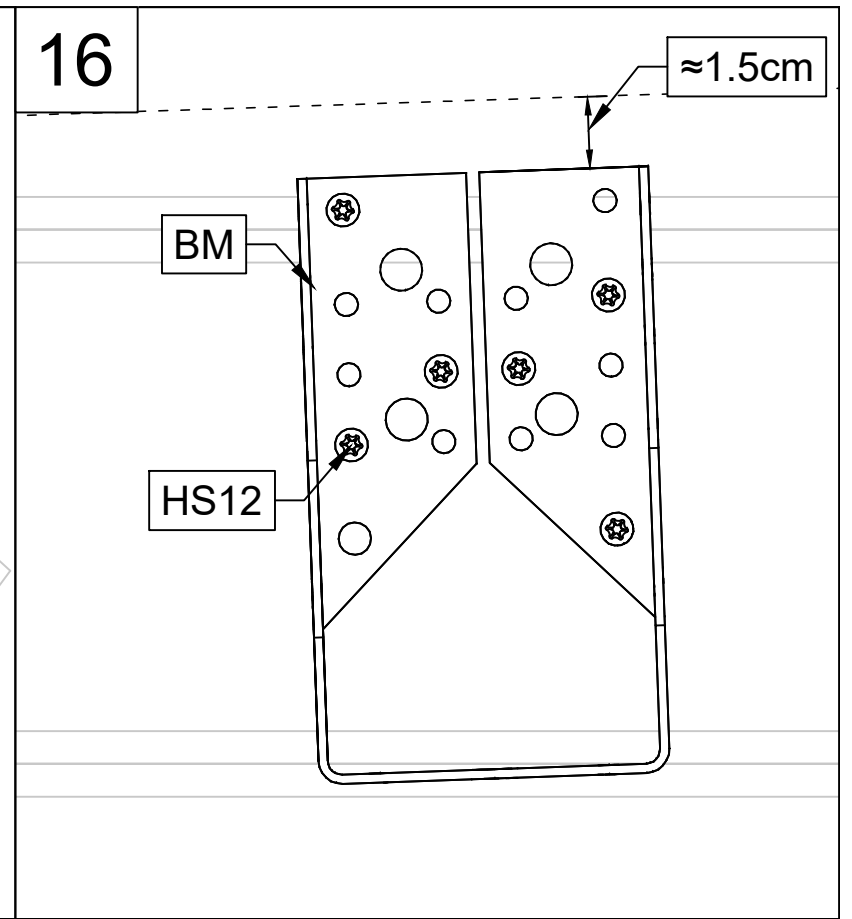
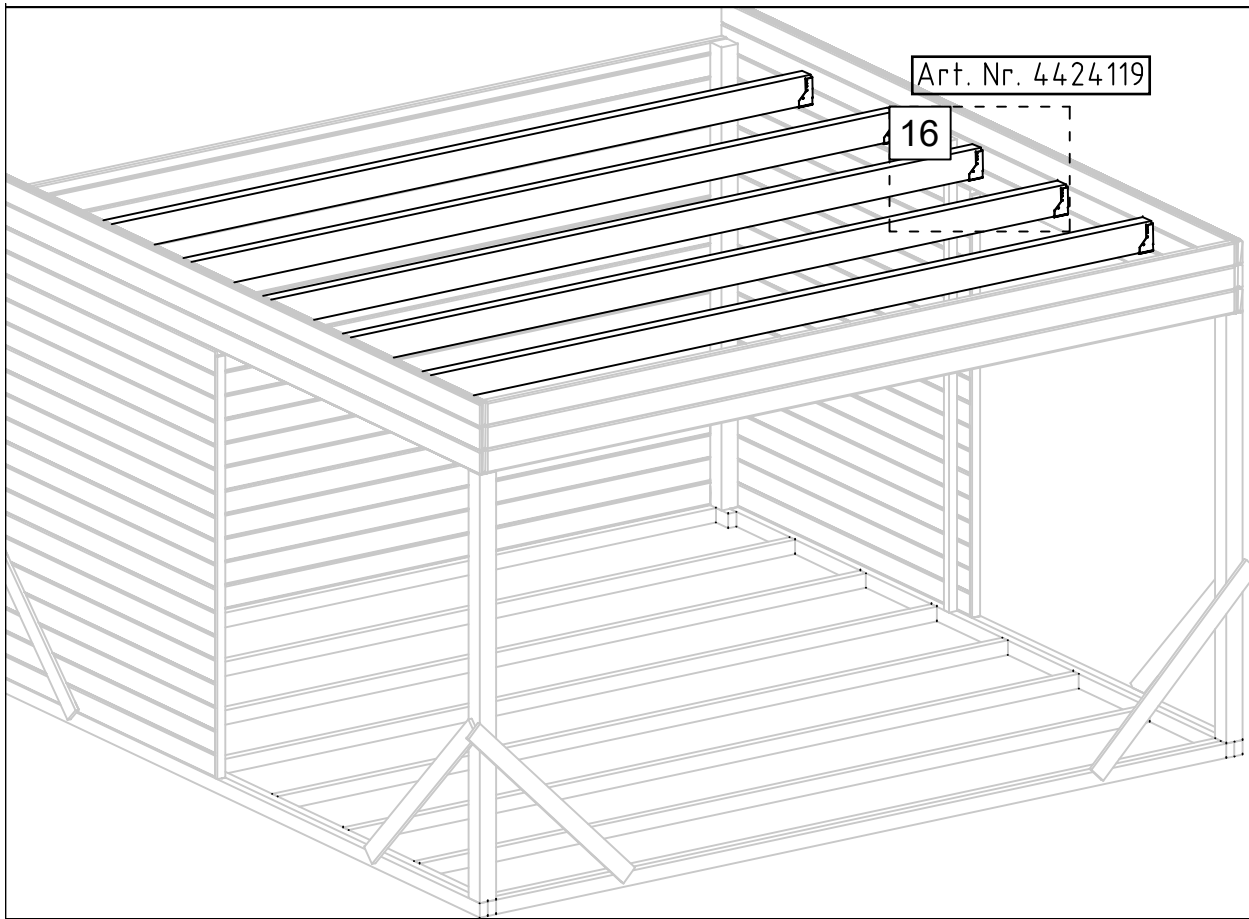

Art. Nr. 4424119

17

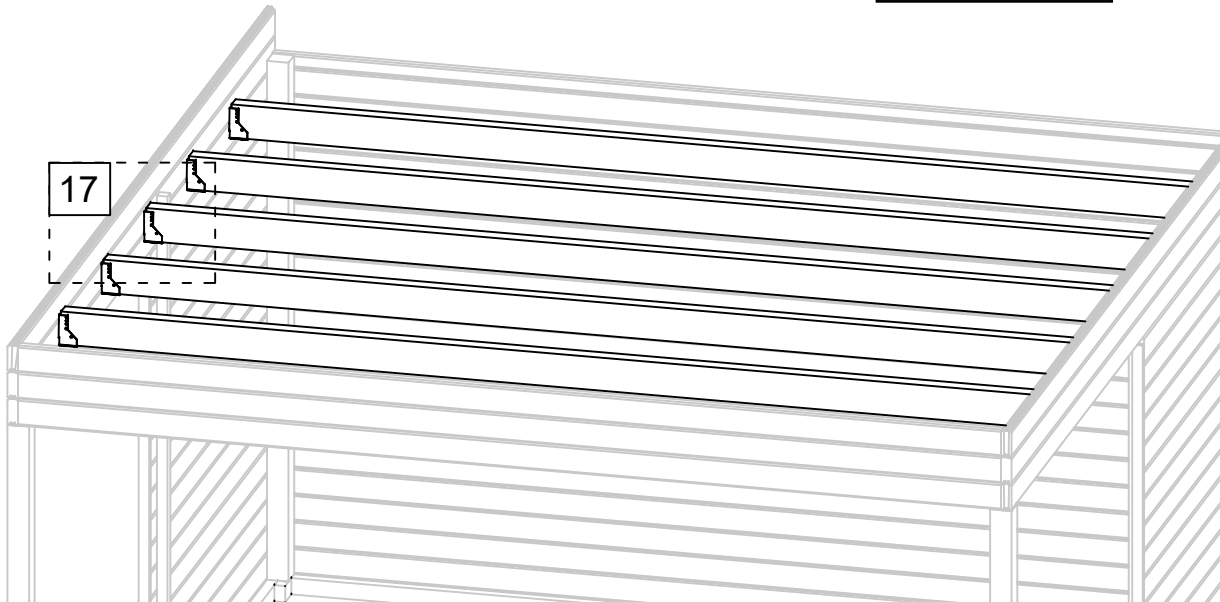

17

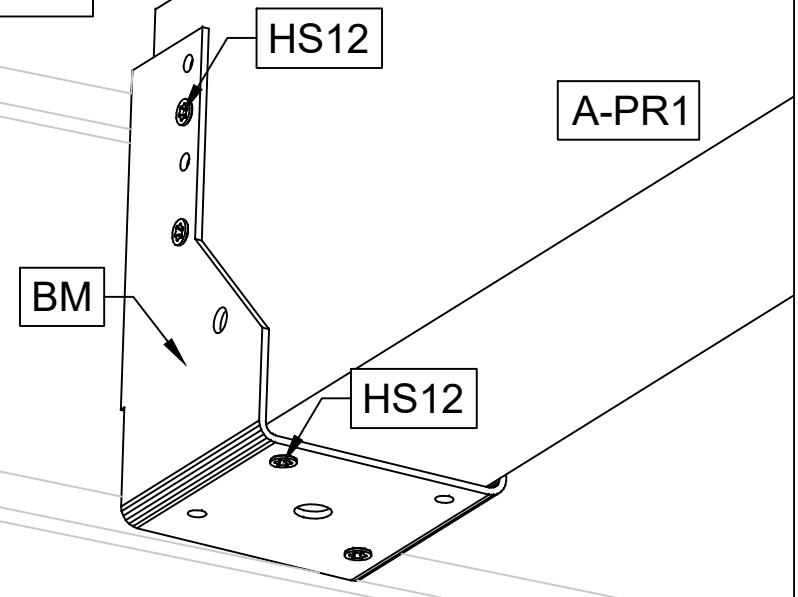

18

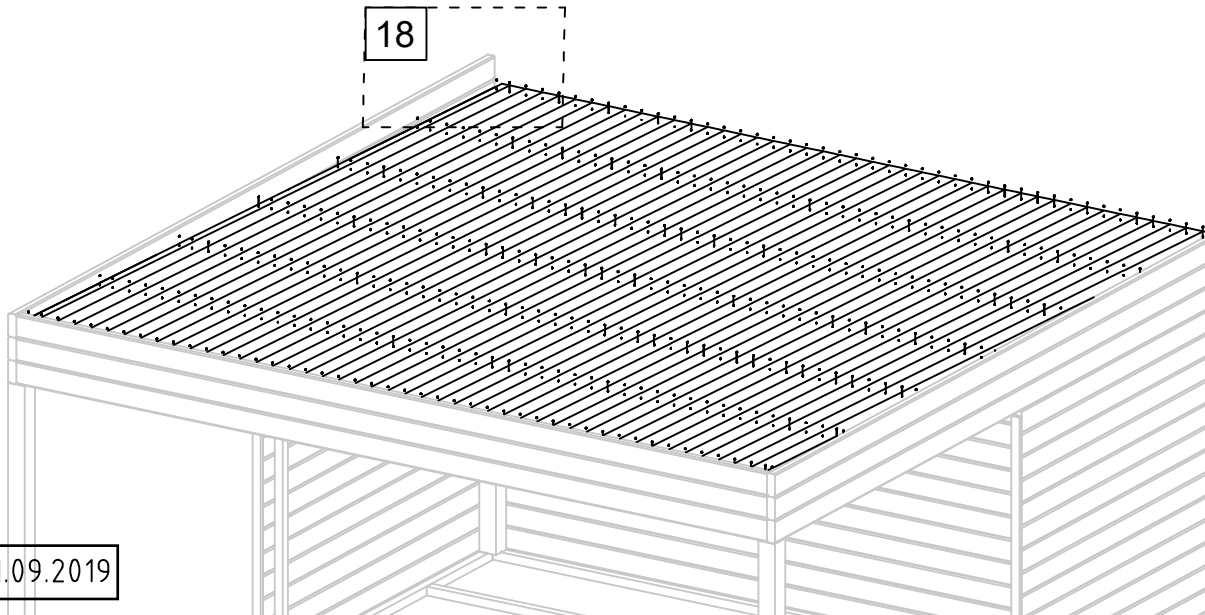

18

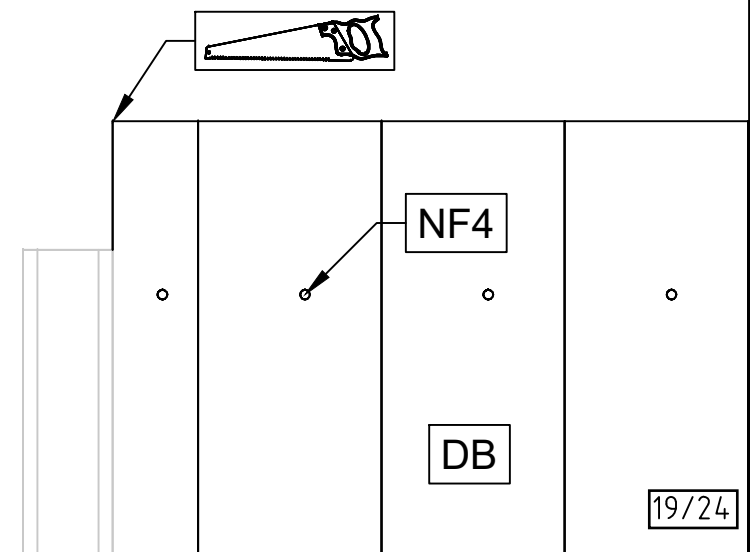

11.09.2019

19/24

Art. Nr. 4424119

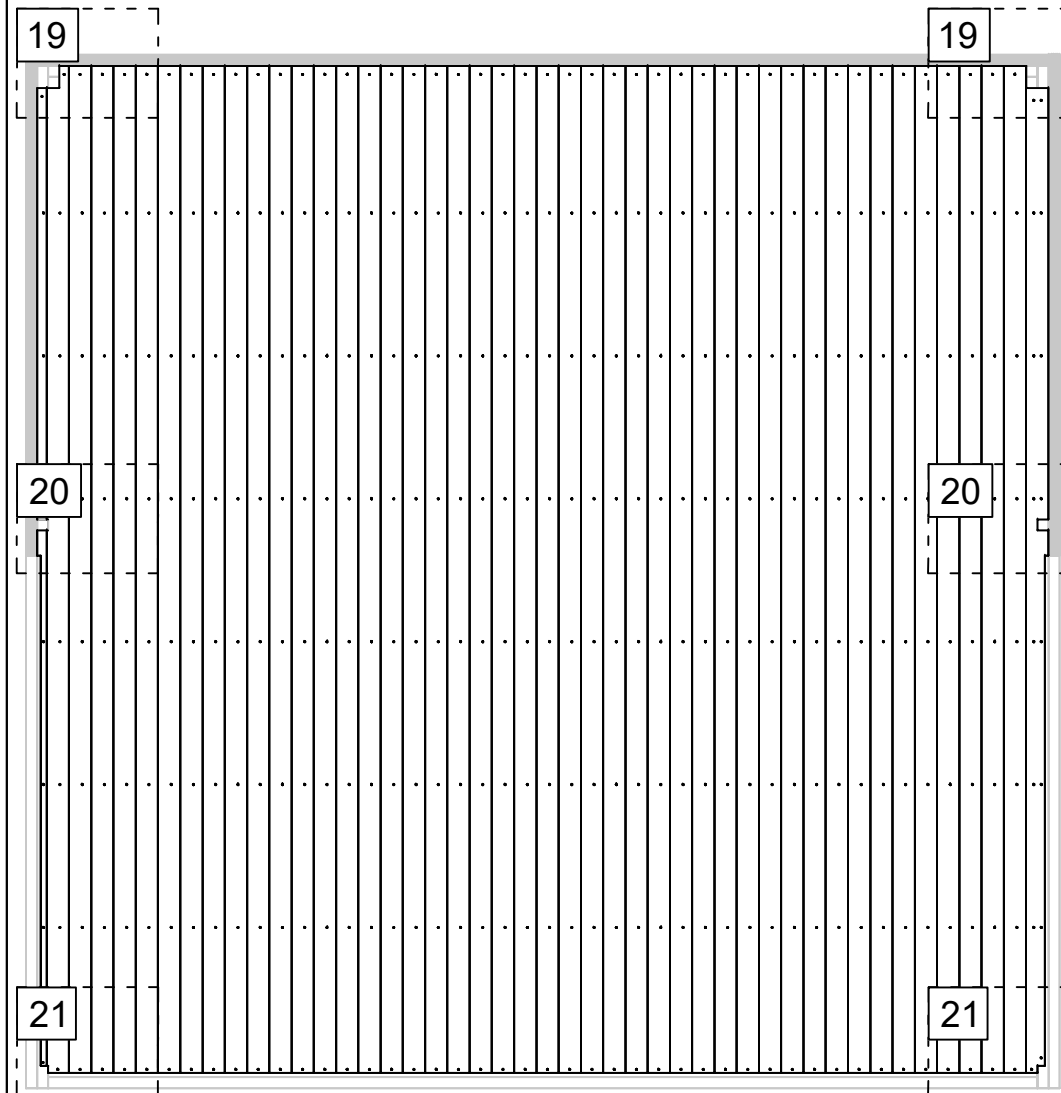
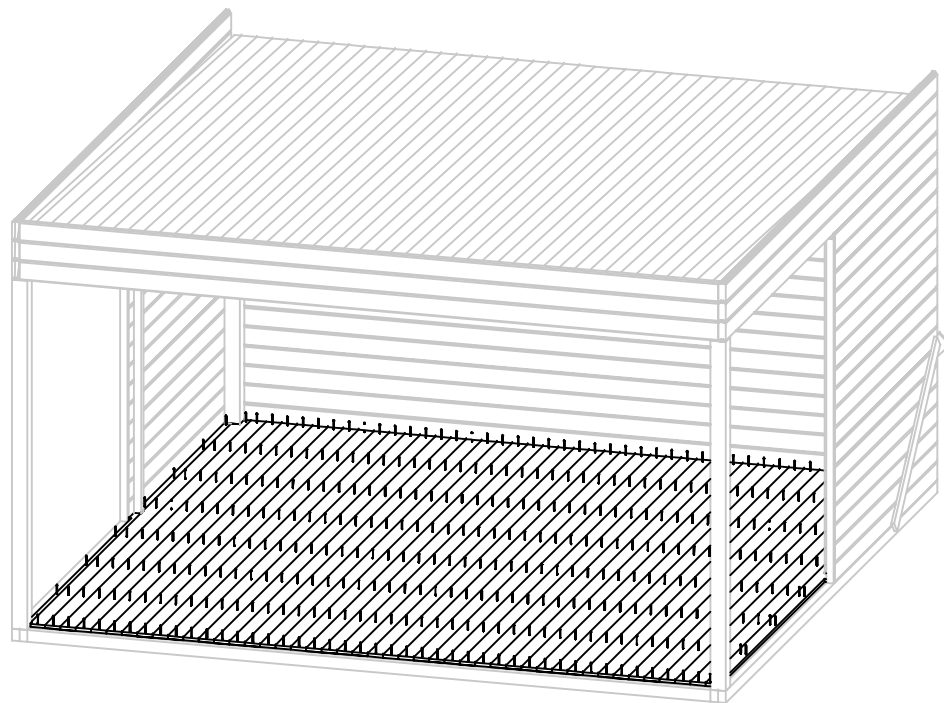

11.09.2019

20/24

19

Art. Nr. 4424119

20

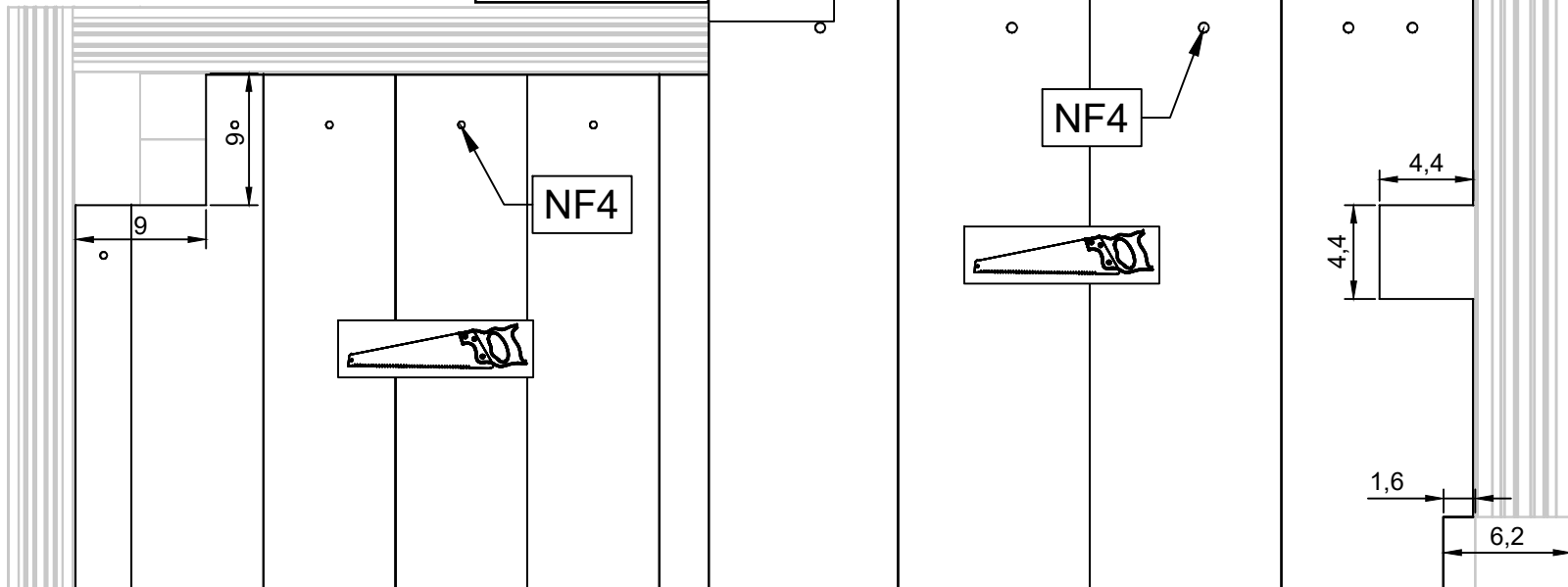

21

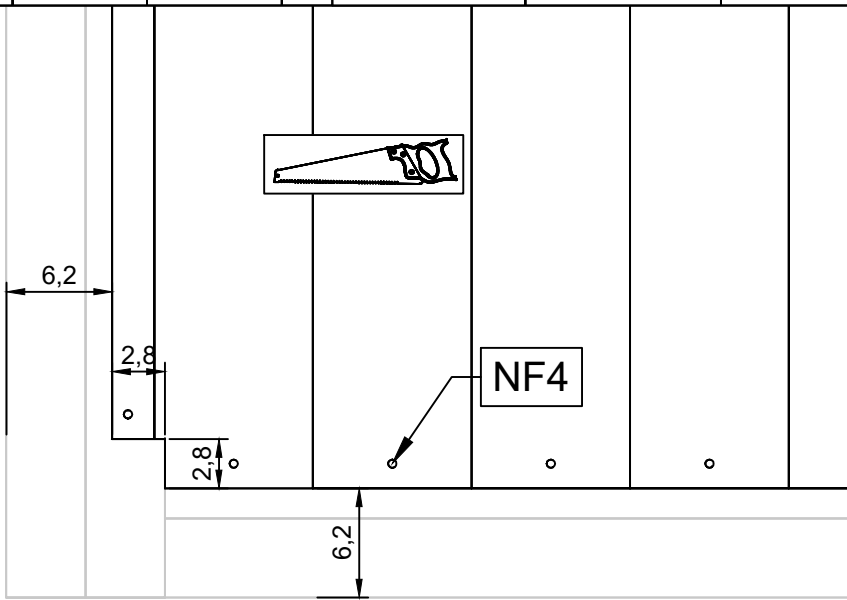

11.09.2019

21/24

Art. Nr. 4424119

22

22

22

HS14

23

AL-1

HS29

11.09.2019

22/24

23

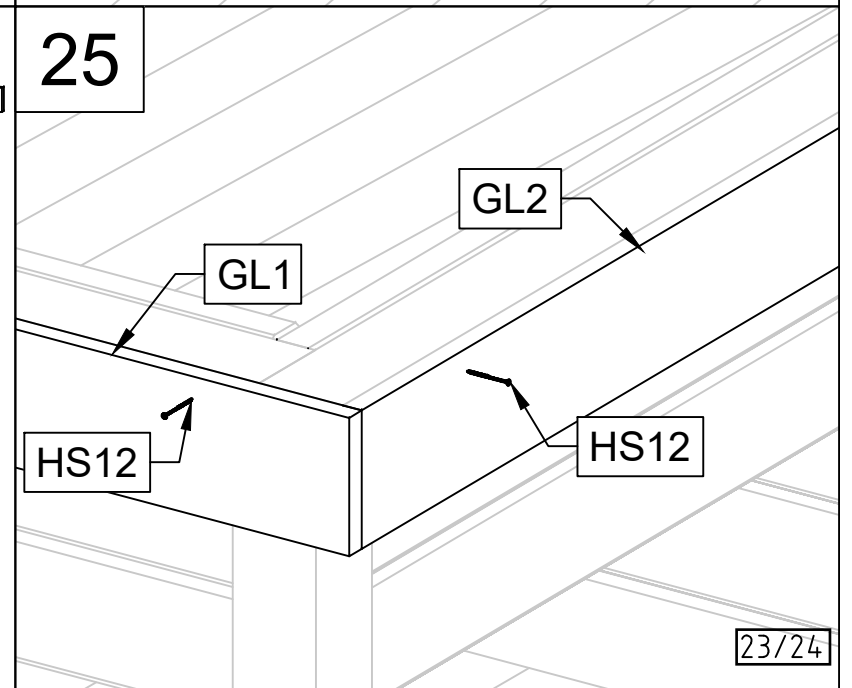
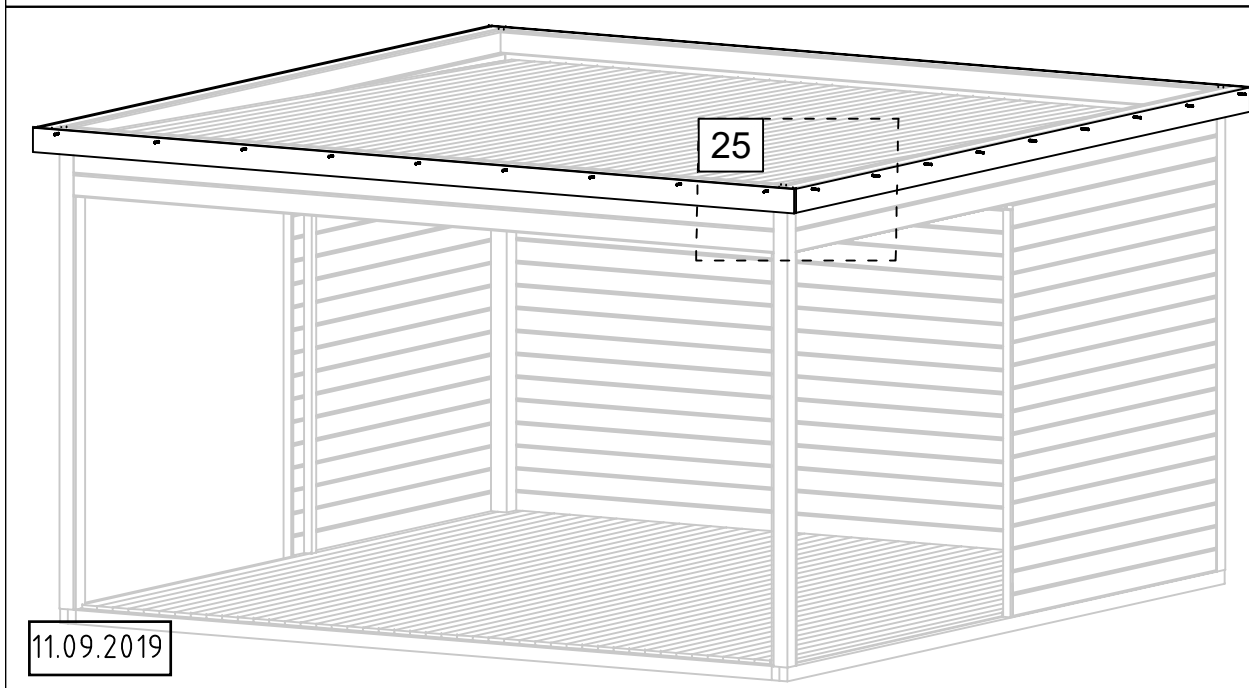
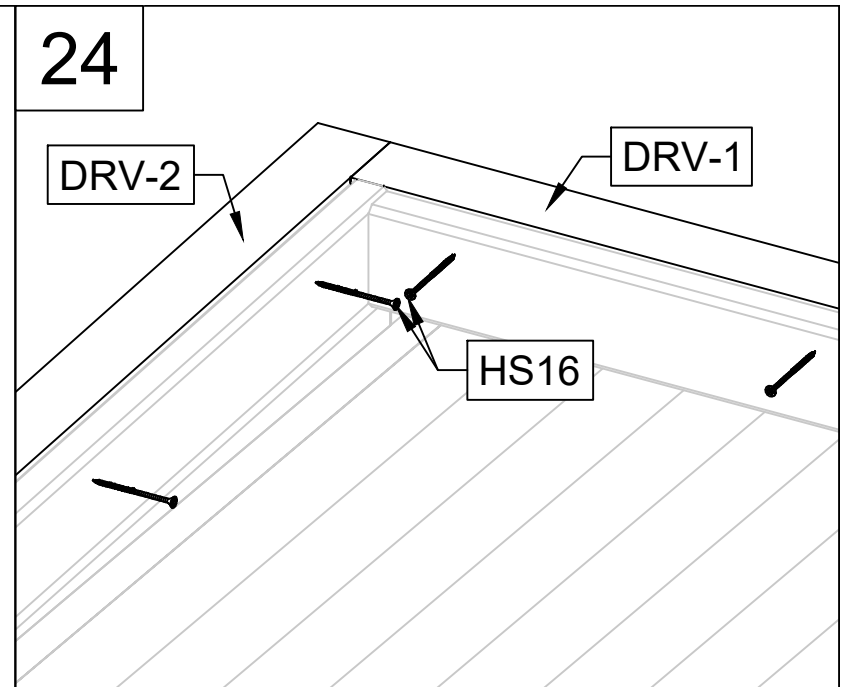
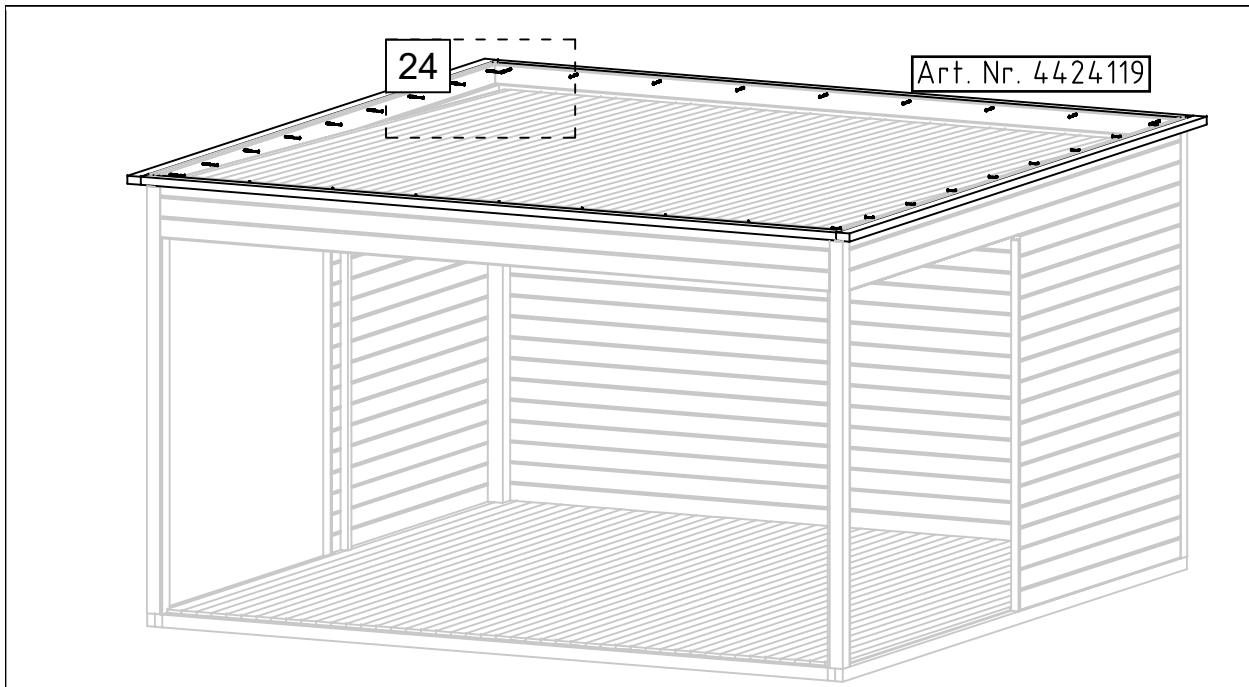

Art. Nr. 4424119

26

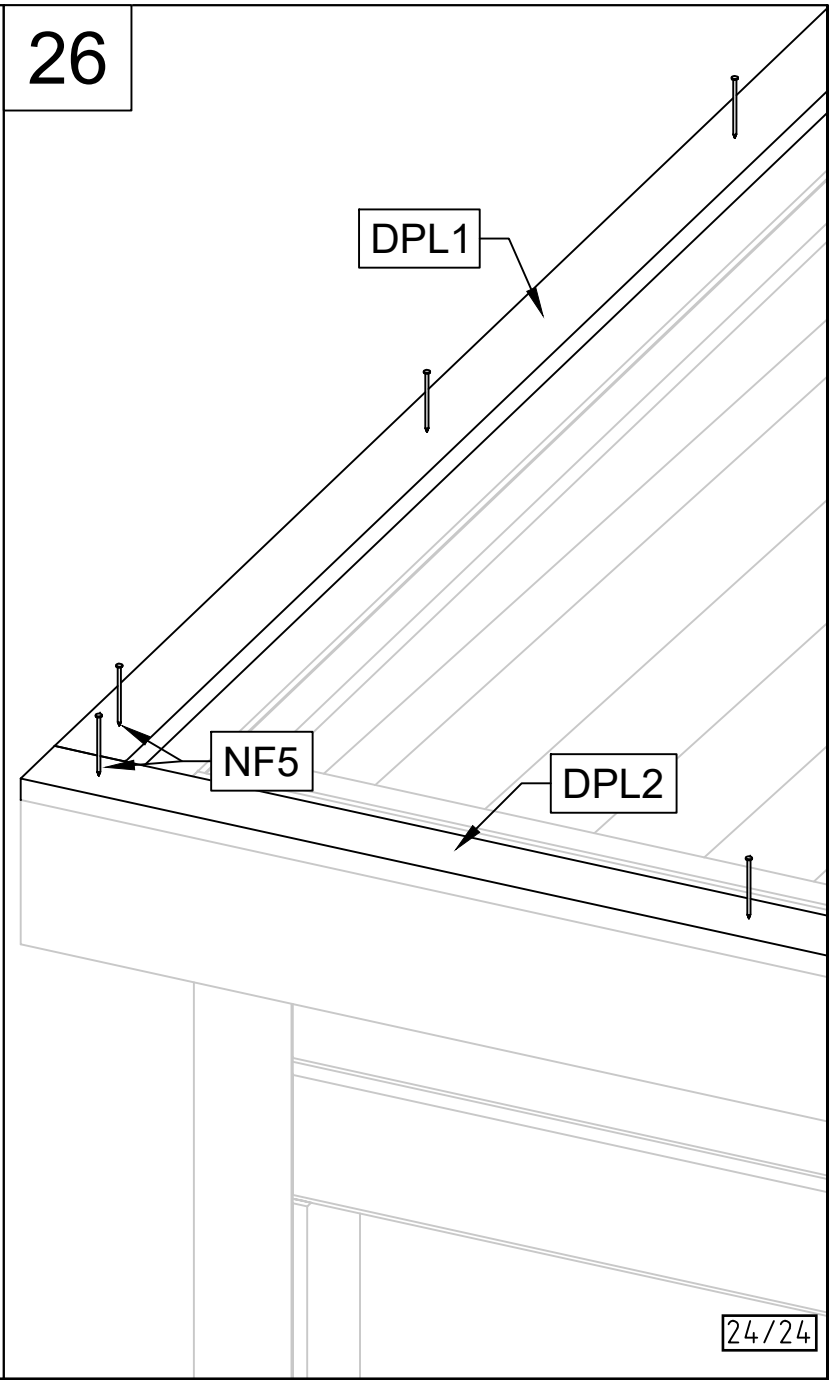
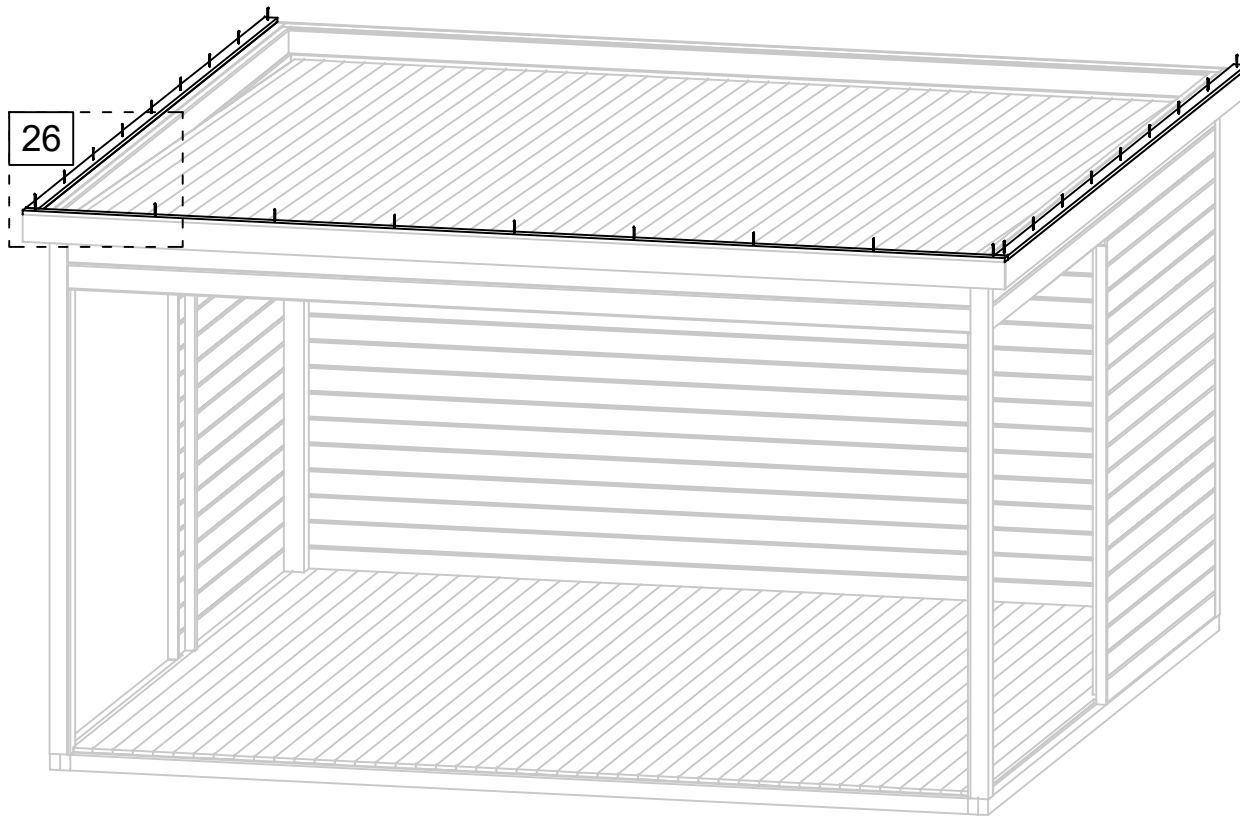

11.09.2019

24/24





Pos	18.02.2018	Piece list - Stückliste - Liste des pièces - Elementi - Stuklijst - Tükítabel 2041x2026 AL.2S.2R. RAL7016	1/1	Q	P (mm)	L (mm)
-----	------------	--	-----	---	-----------	-----------



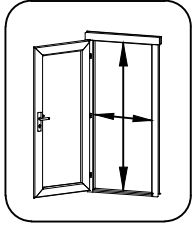

Glass size - Glasgröße - Taille de la vitre - Misura del vetro - Glas afmeting - Klaasi mõõt: 926x1859 mm

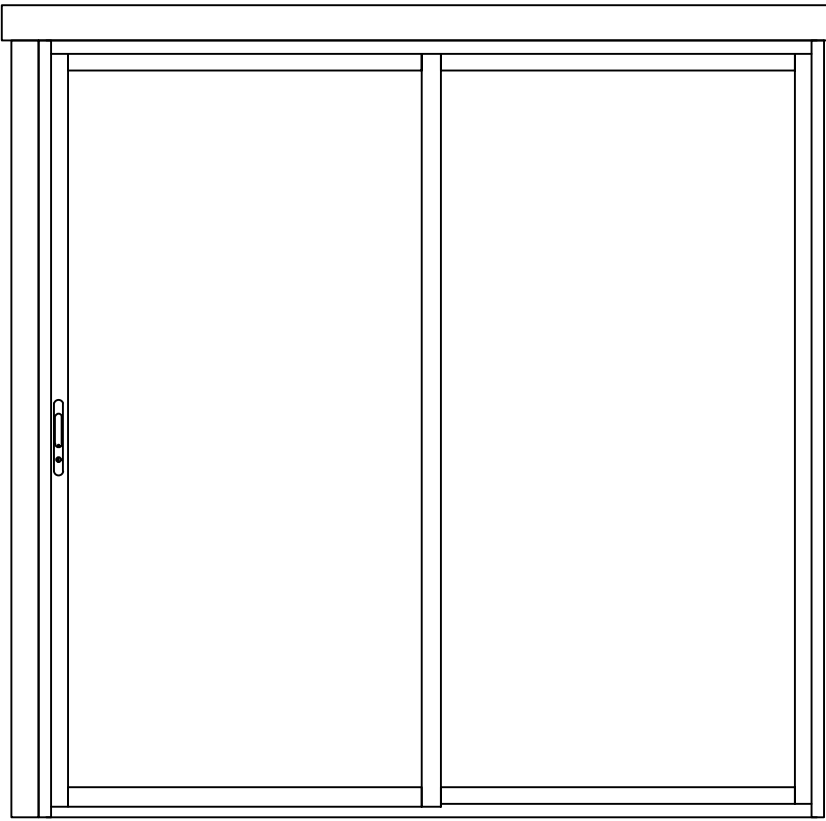

950x1930 mm

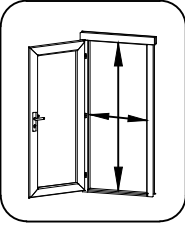
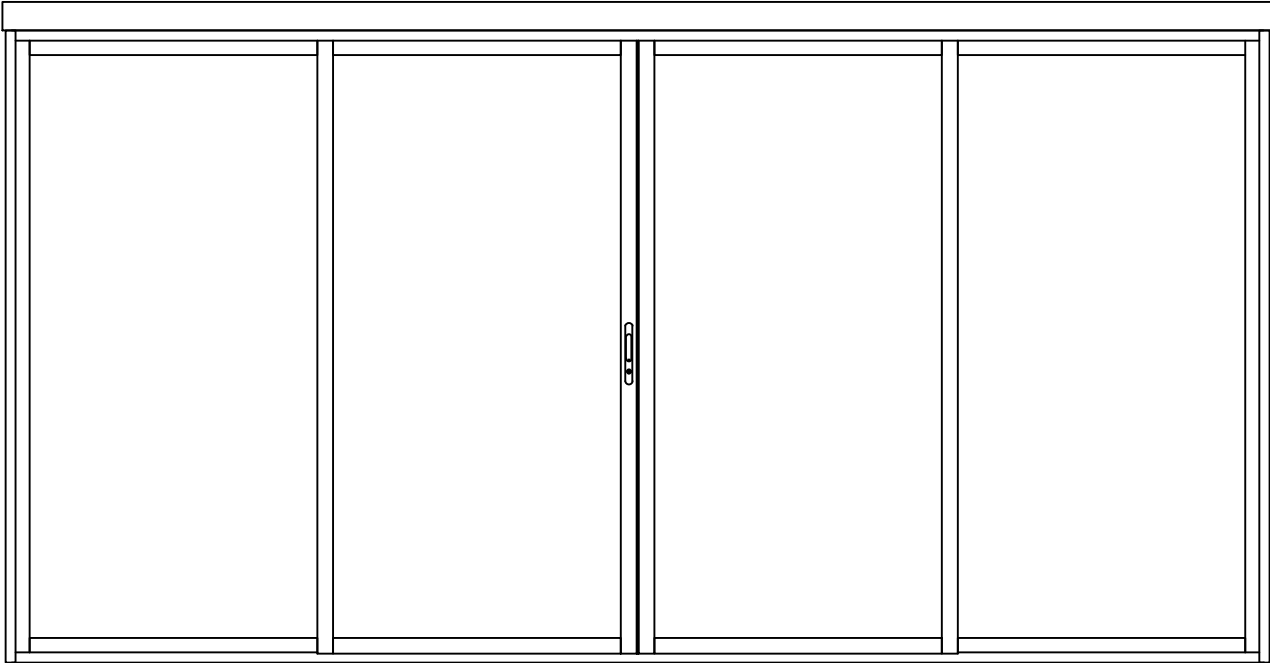
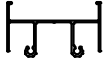

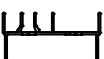
12	Upper door jamb - Türrahmen oben - Cadre de porte supérieur - Telaio superiore della porta - Bovendorpet - Ükse ütemine teng		1	35x60	1982
9	Doorstep - Swelle - Seuil de porte - Callare - Drempel - Lävepakk ukseavale		1	35x60	1982
10-11	Door jamb - Türrahmen - Cadre de porte - Telaio montante della porta - Deurframe - Ükse teng		2	32x63	2000

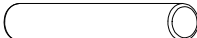
Pos	07.02.2019	Piece list - Stückliste - Liste des pièces - Elementi - Stuklijst - Tükitalabel 4000x2026 AL.2S.4R. RAL 7016	1/1	Q	P (mm)	L (mm)
Glass size - Glasgröße - Taille de la vitre - Misura del vetro - Glas afmeting - Klaasi mõõt: 926x1859 mm					 1900x1930 mm	
						
4	Upper door jamb - Türrahmen oben - Cadre de porte supérieur - Telaio superiore della porta - Bovendorpel - Ukse ütemine teng			2	35x60	1980
1	Doorstep - Swelle - Seuil de porte - Callare - Drempel - Lävepakki ukseavale			2	35x60	1980
3	Left door jamb - Türrahmen links - Cadre de porte gauche - Telaio montante sinistro della porta - Linkerstijl deurframe - Ukse vasak teng			1	32x63	2000
2	Right door jamb - Türrahmen rechts - Cadre de porte droit - Telaio montante destro della porta - Rechterstijl deurframe - Ukse prem teng			1	32x63	2000
	Pin - Pin - Épingle - Perno - Pin - Tihvt			4		

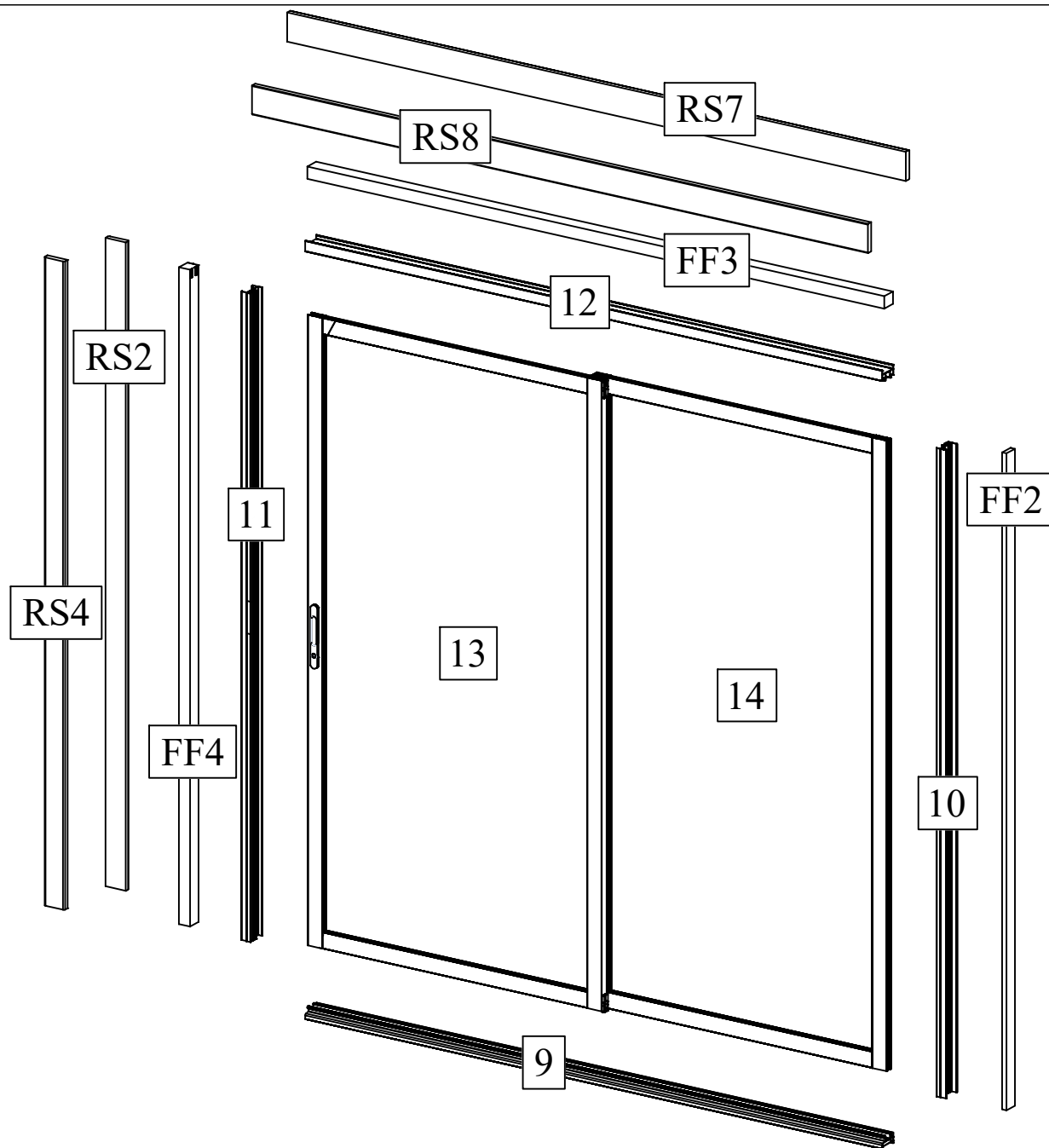

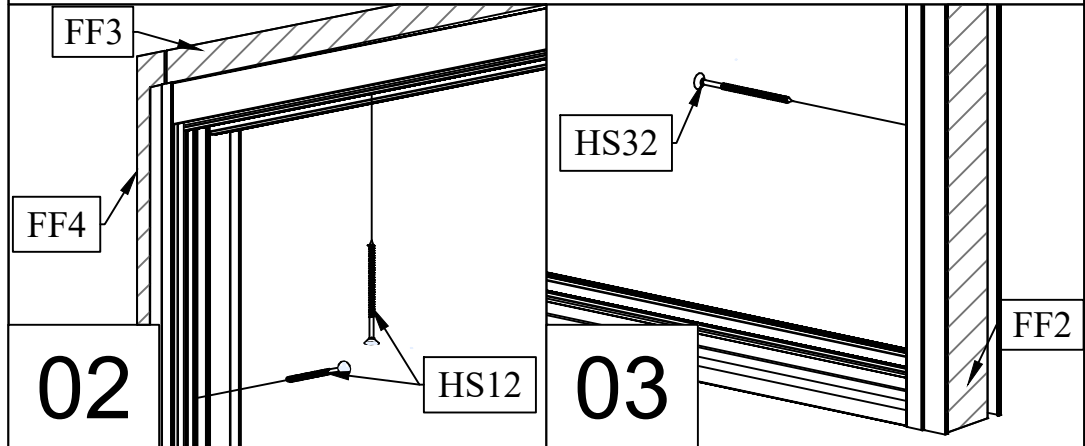
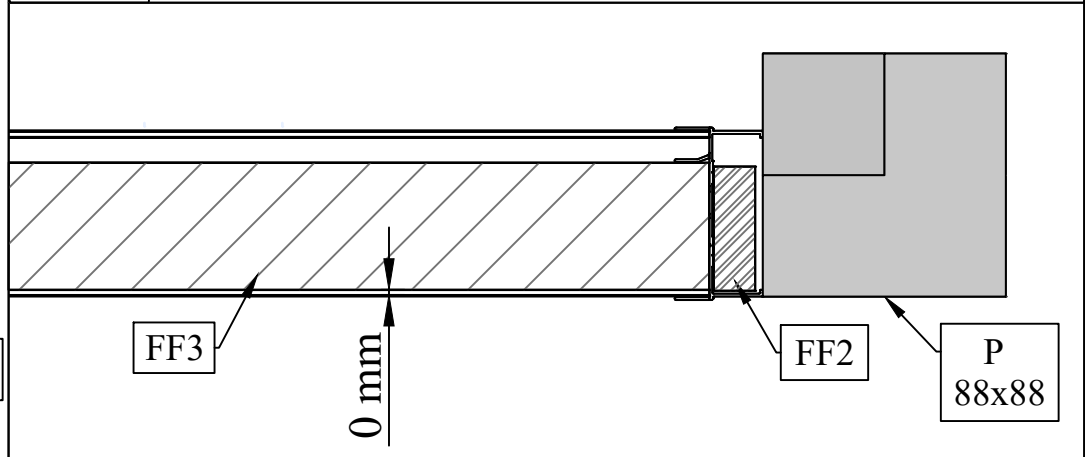
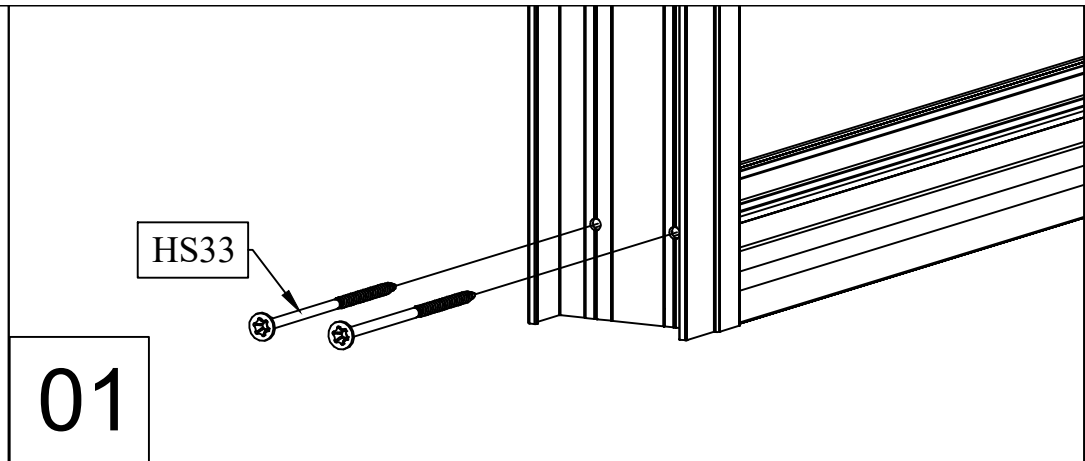
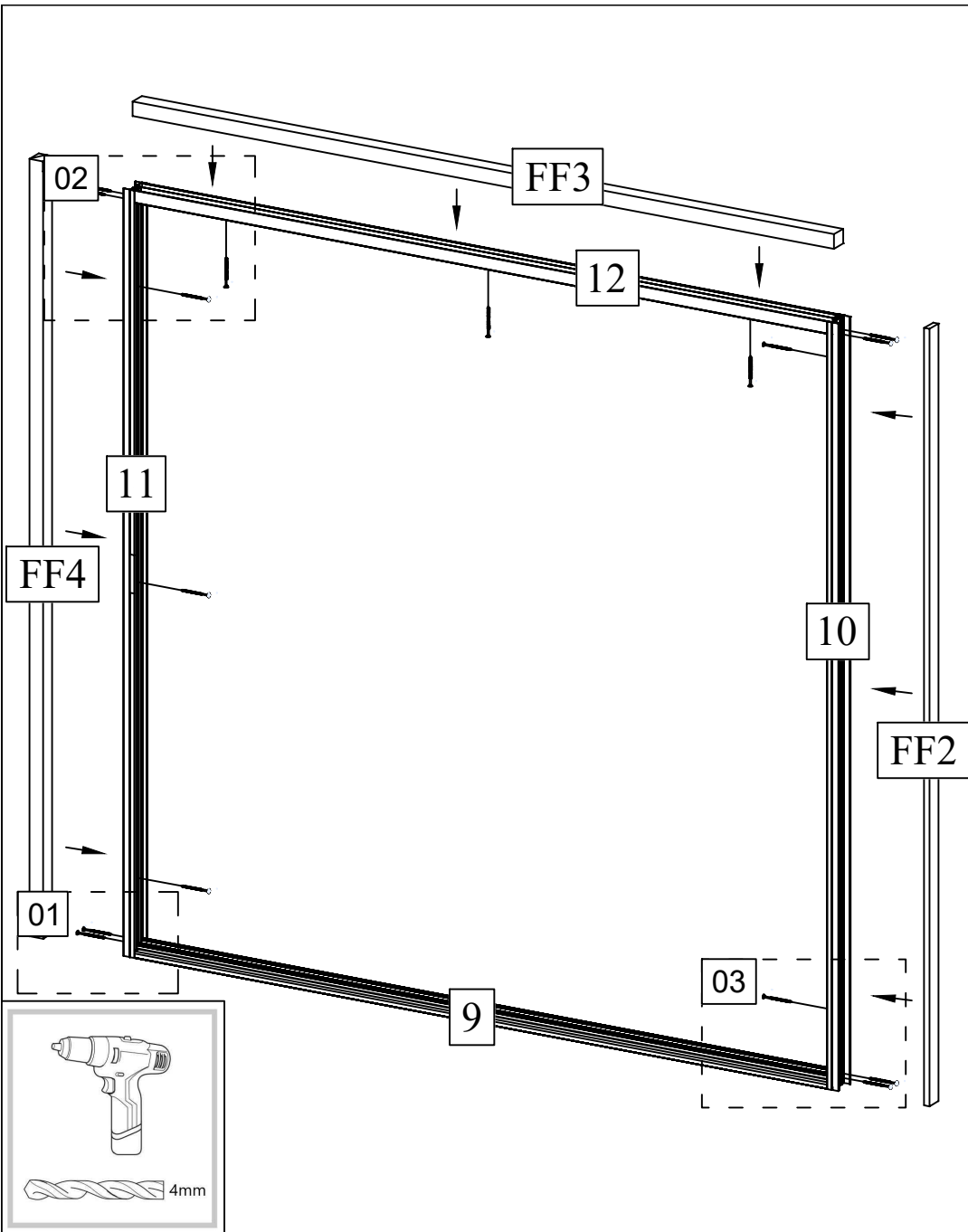

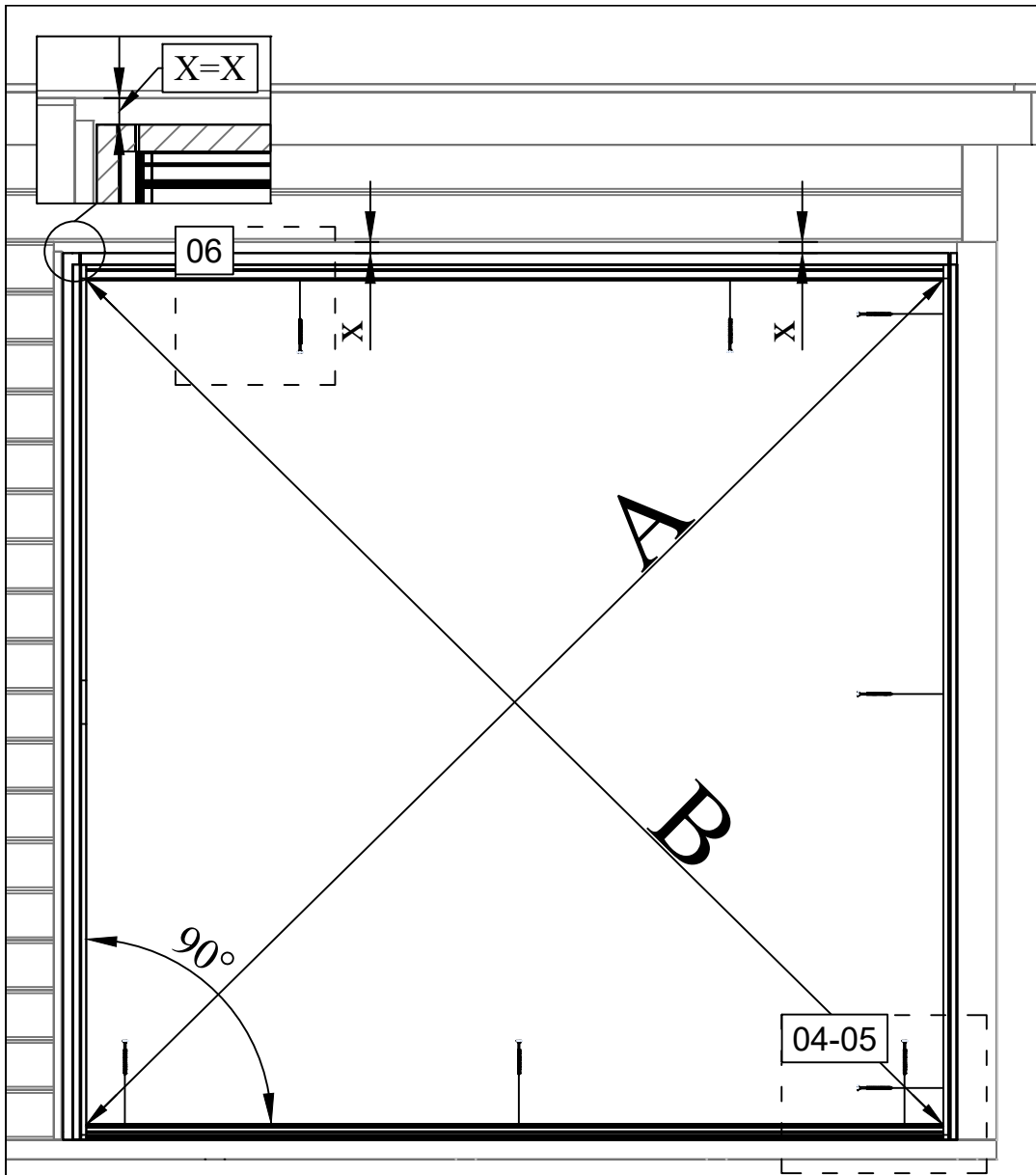

**A=B**

**04**

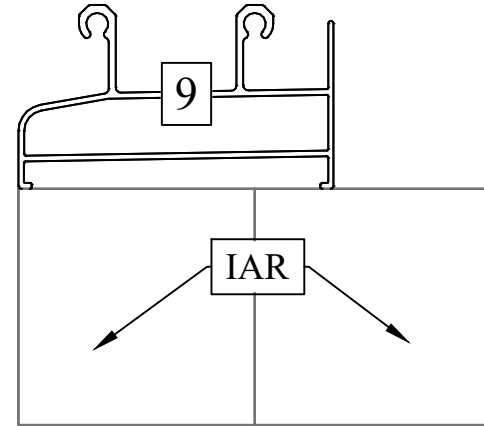

**05**

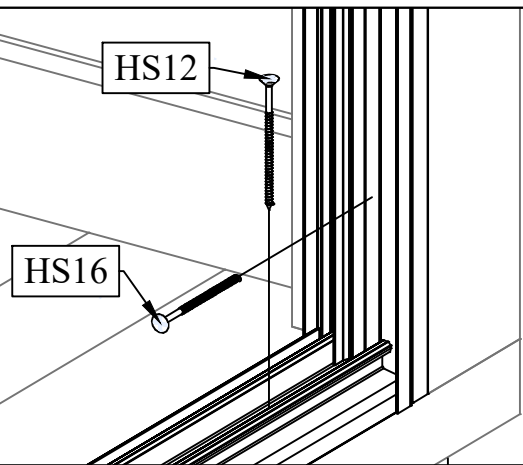

**06**

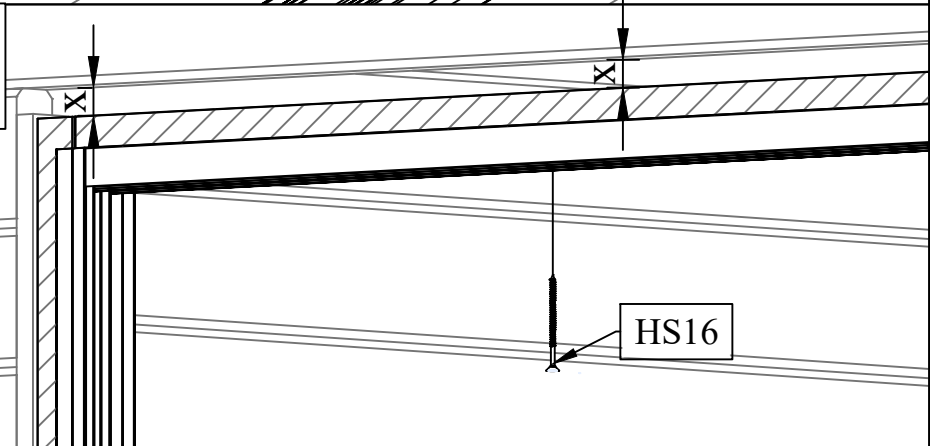

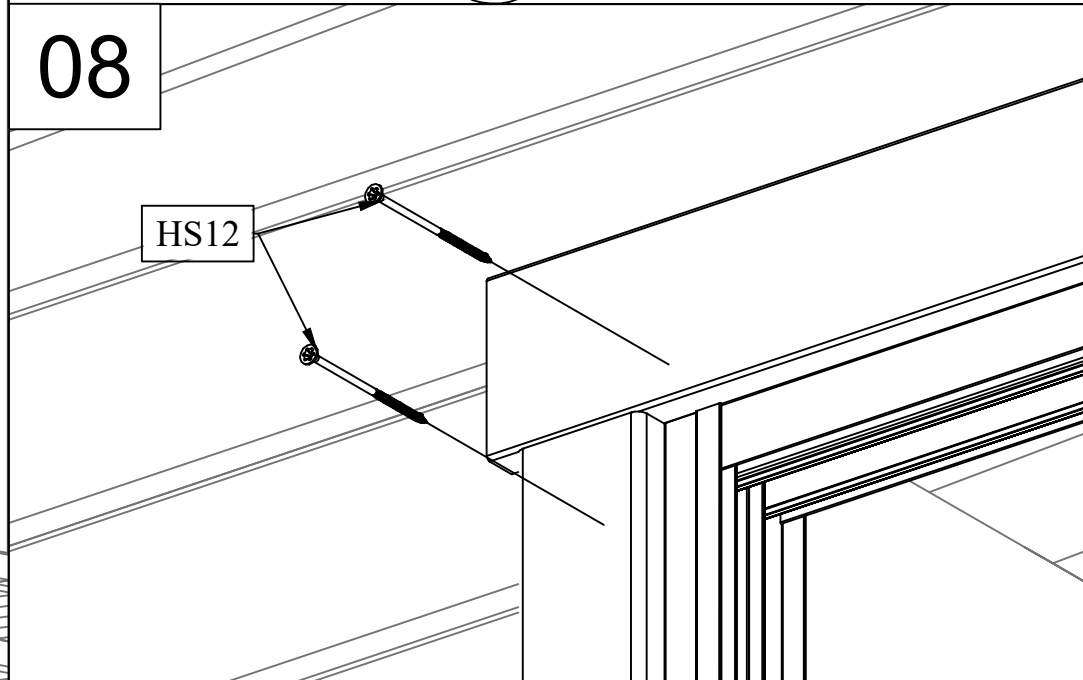
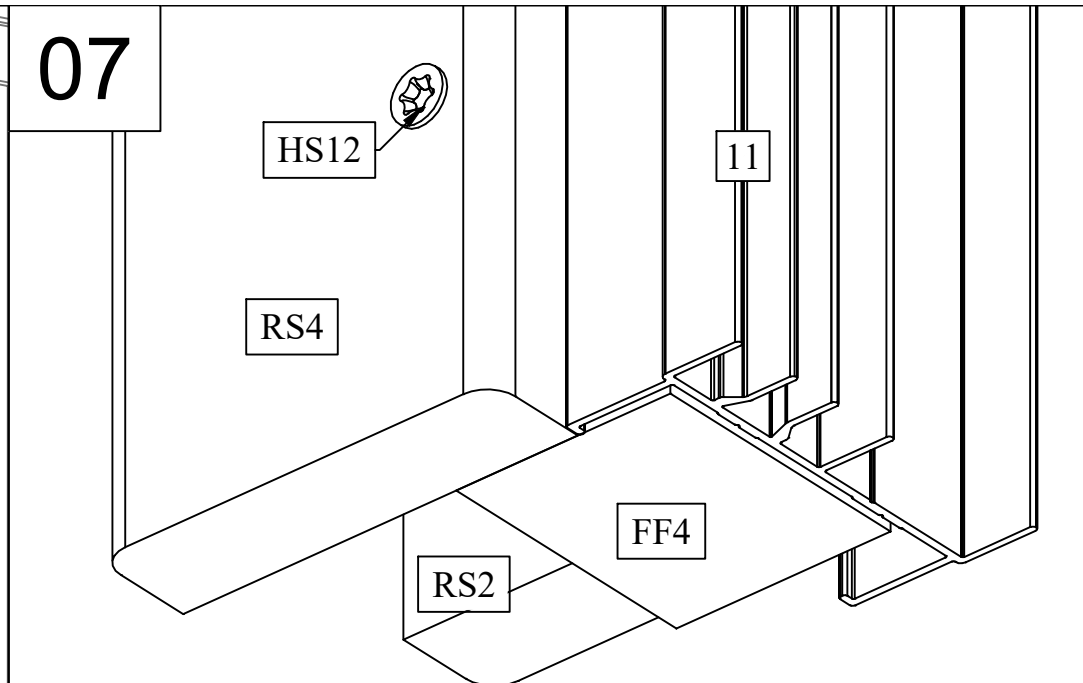
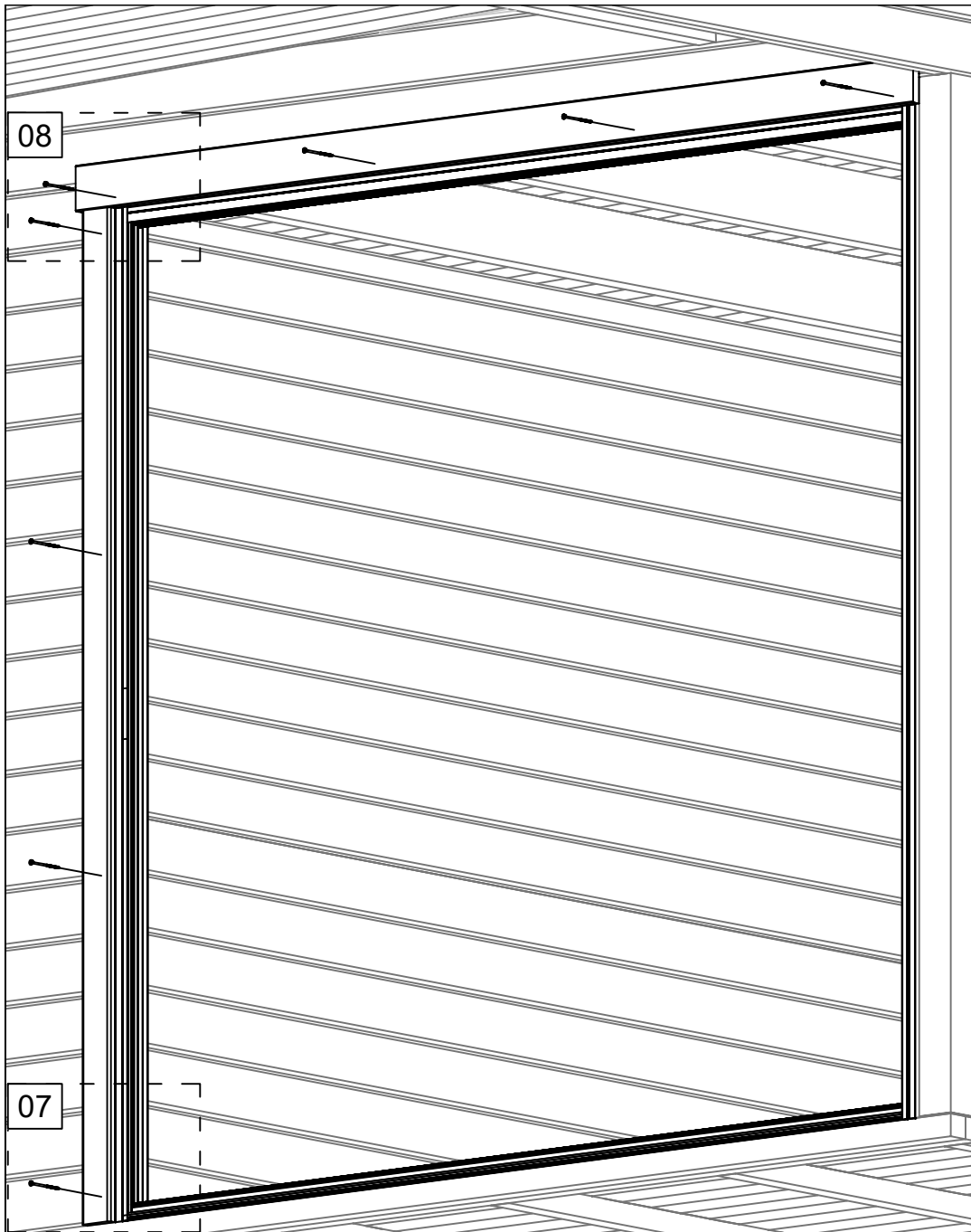

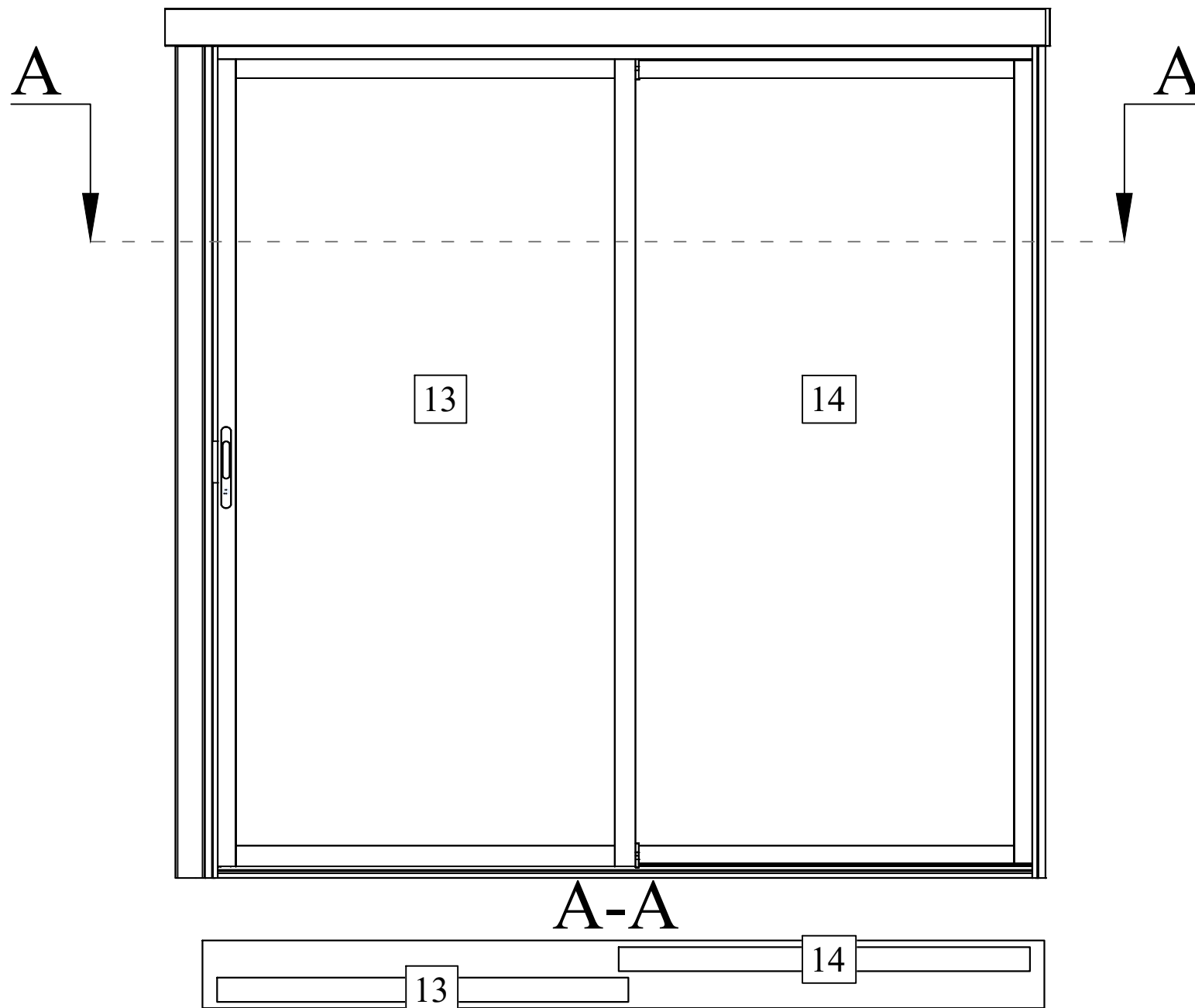



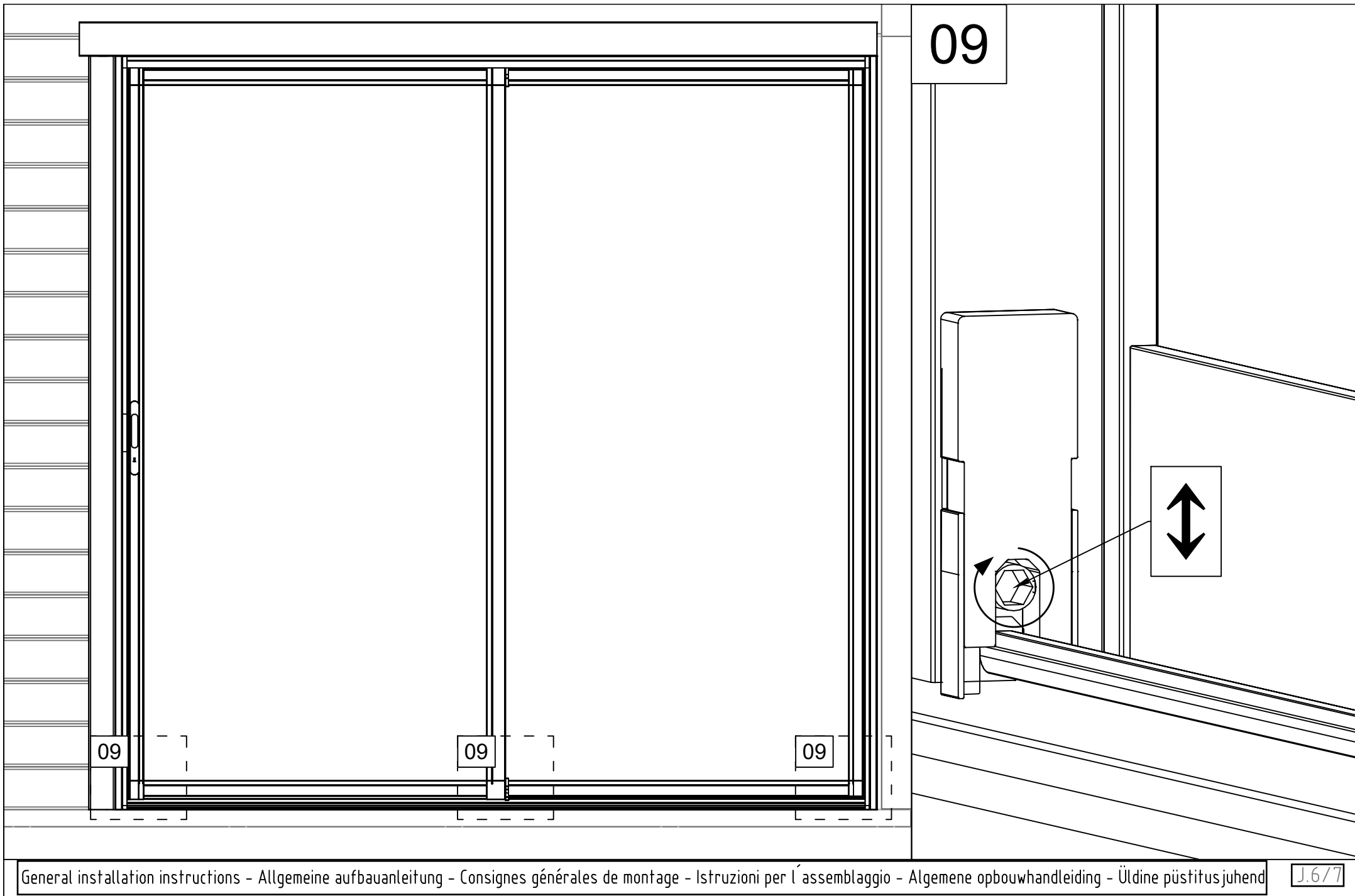

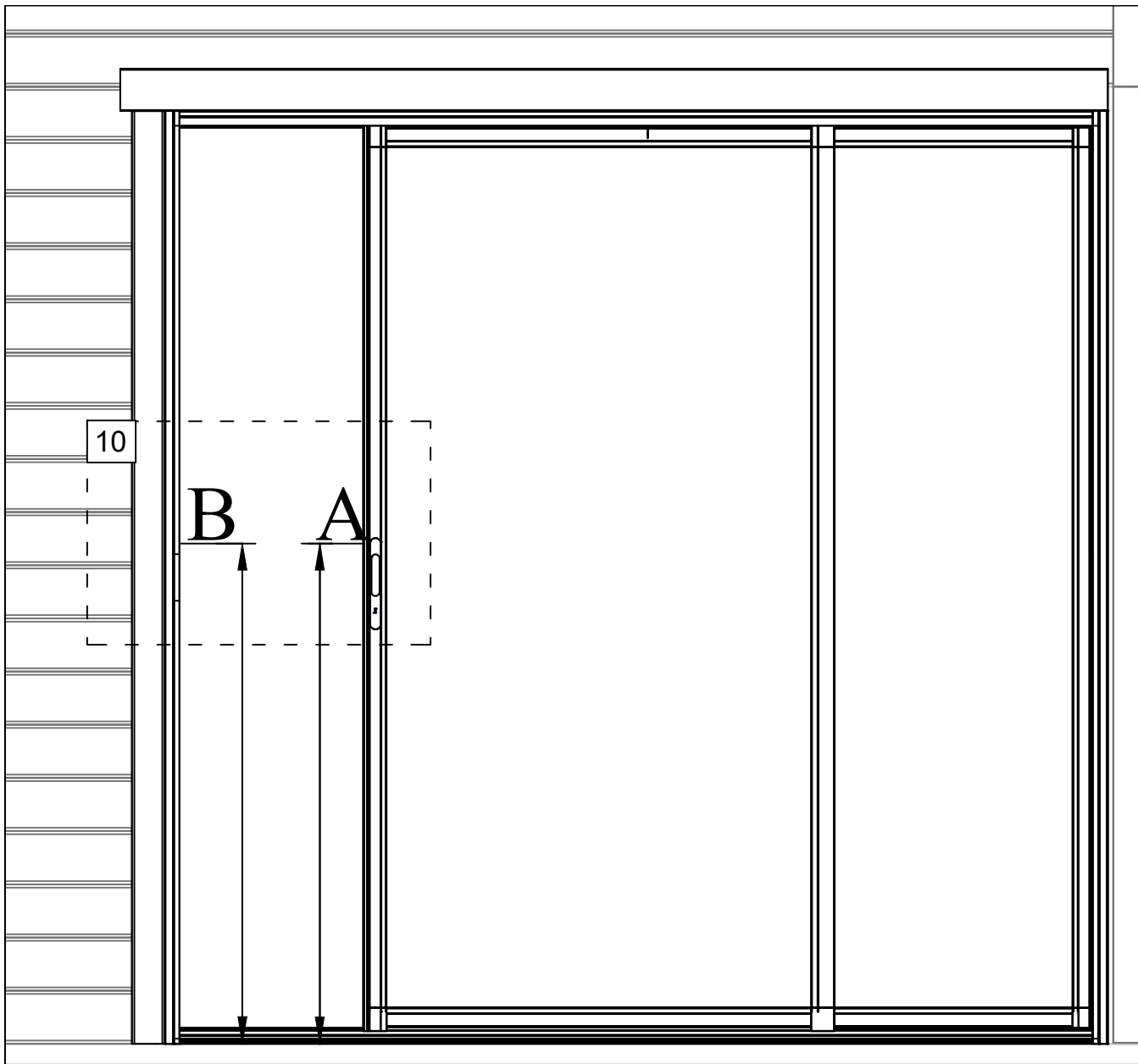

$$A=B$$

10

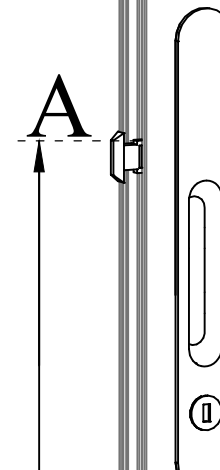

10

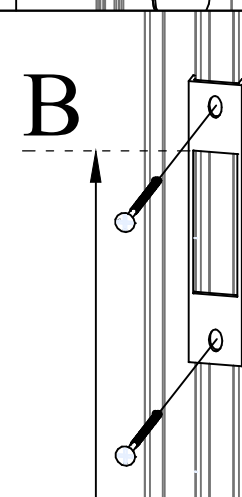

B



A

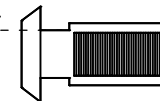

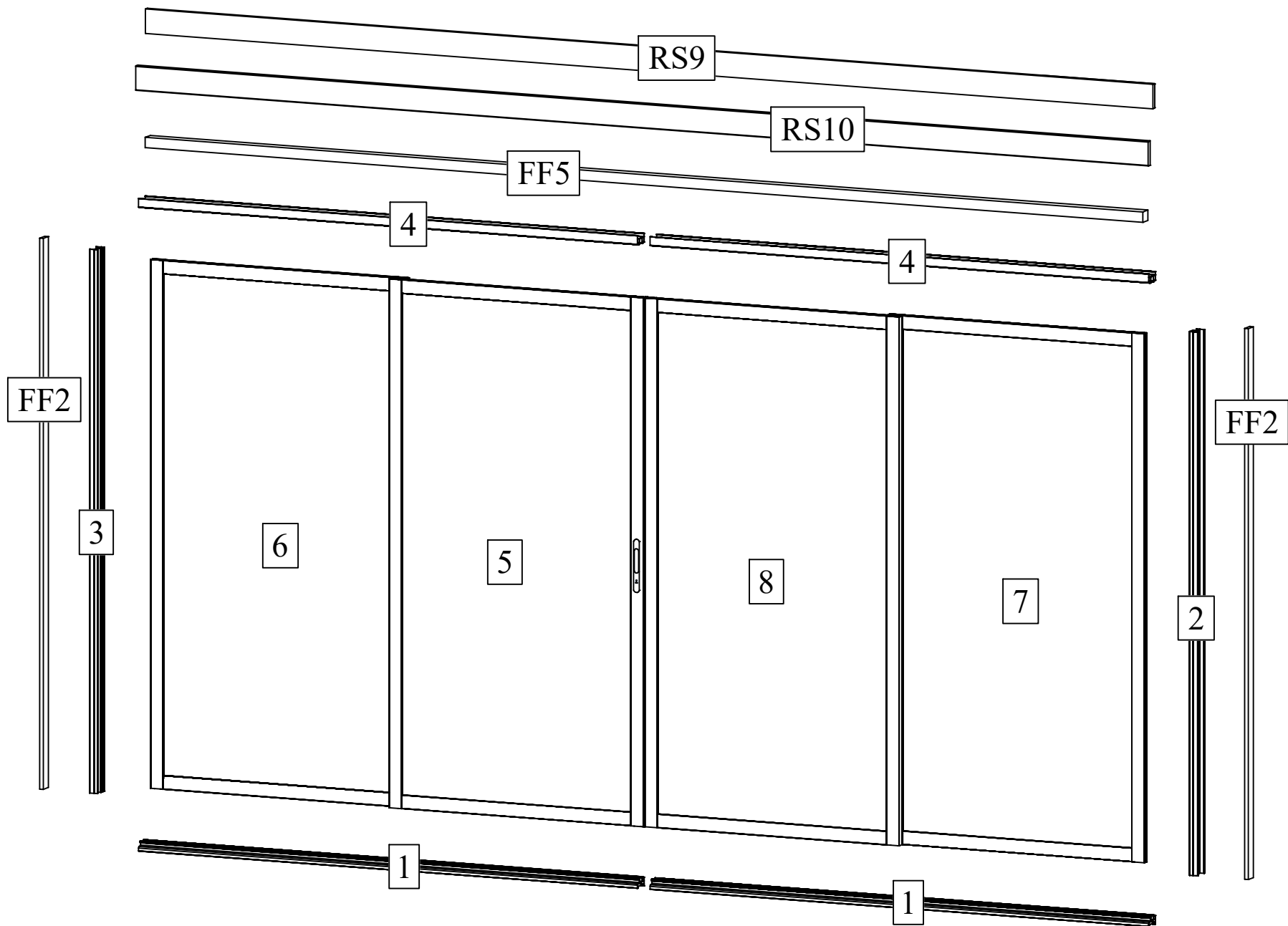

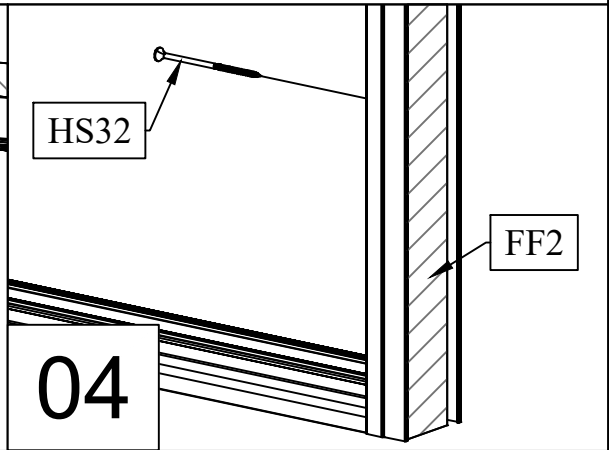
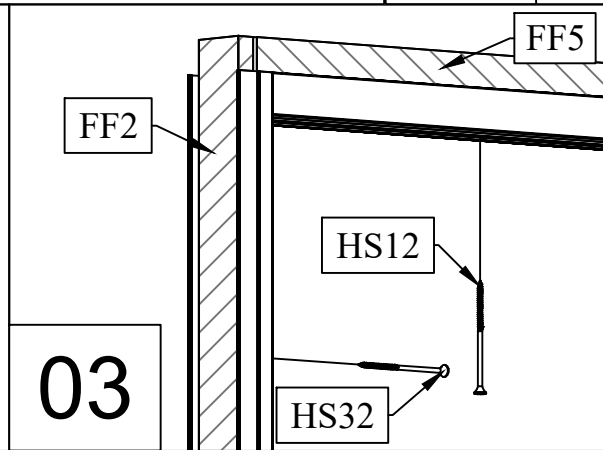
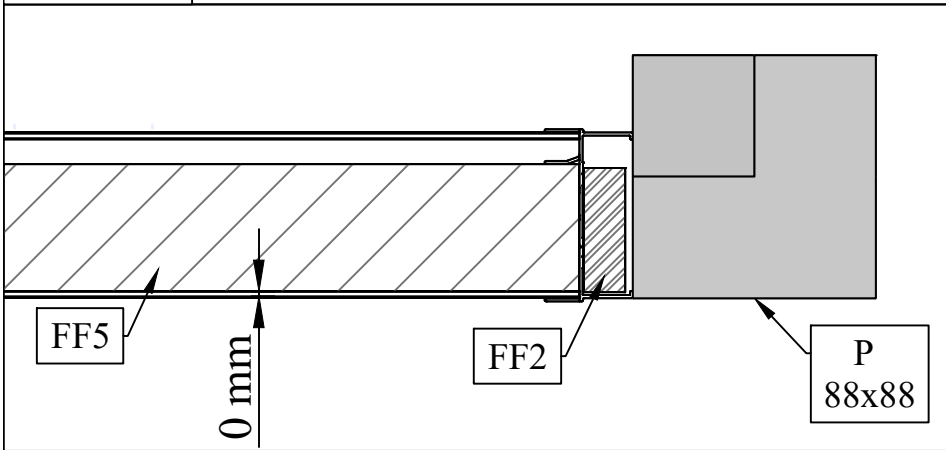
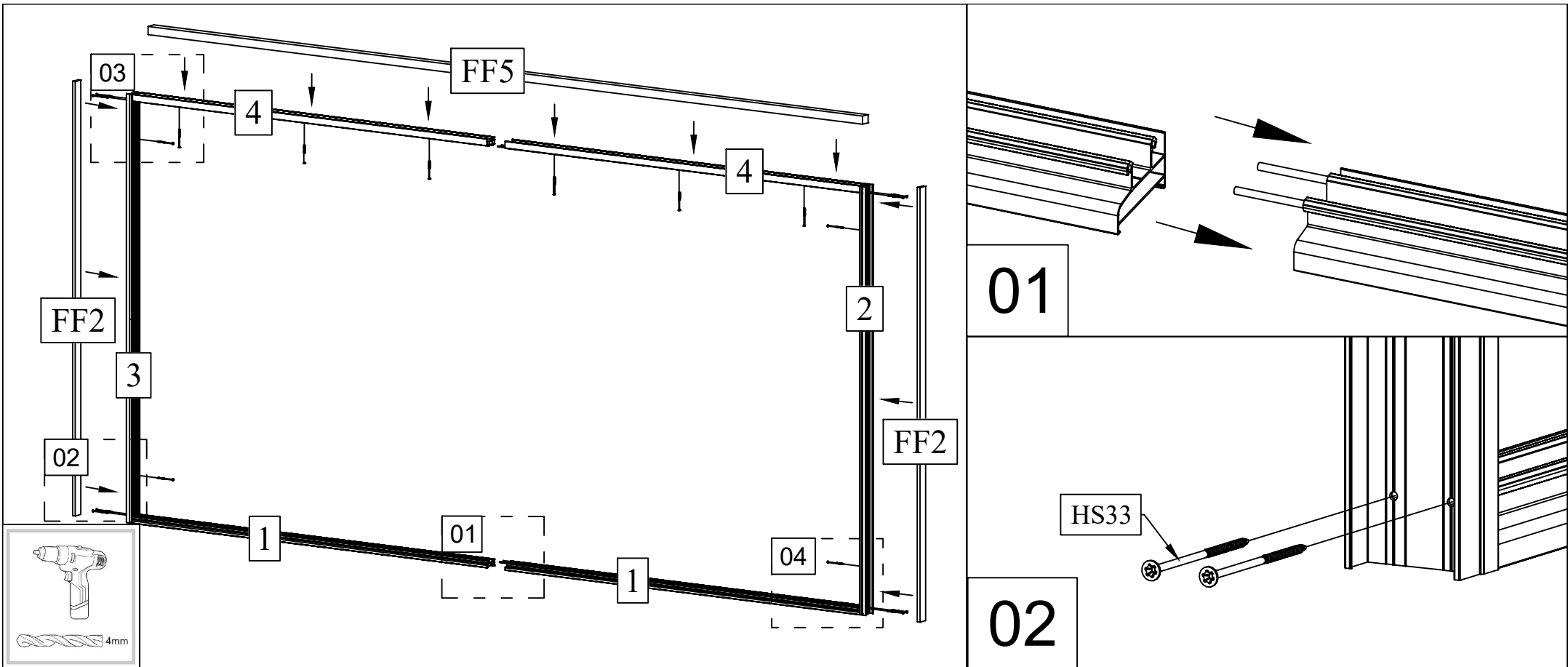

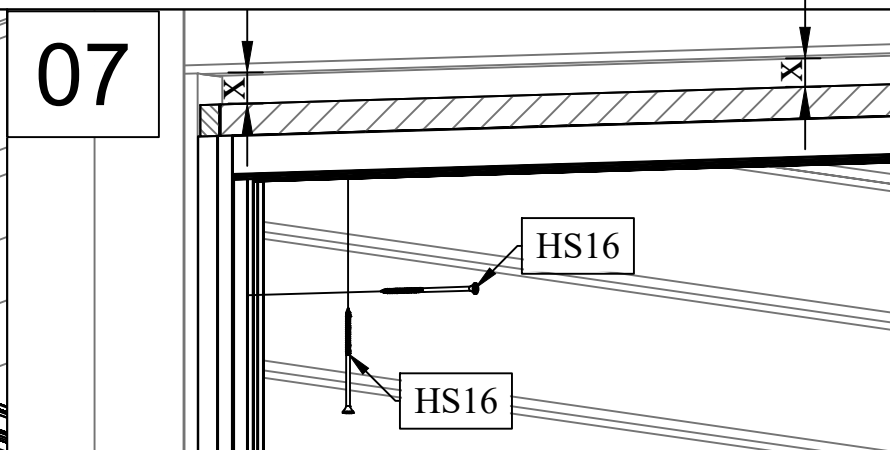
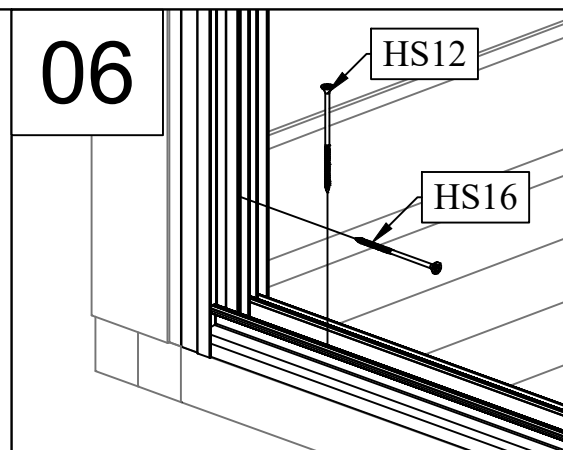
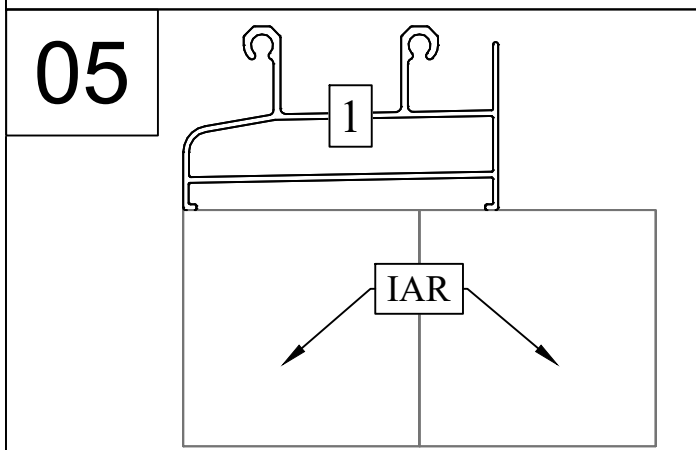
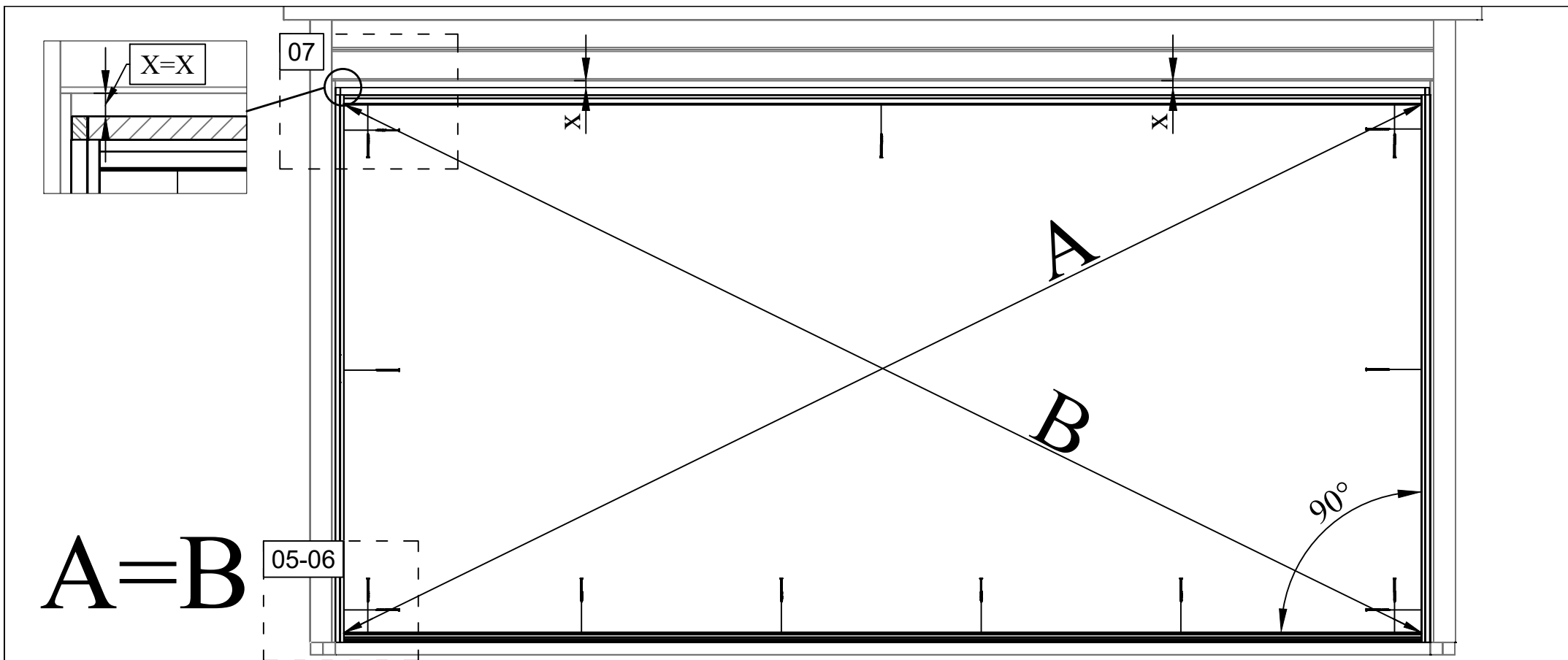

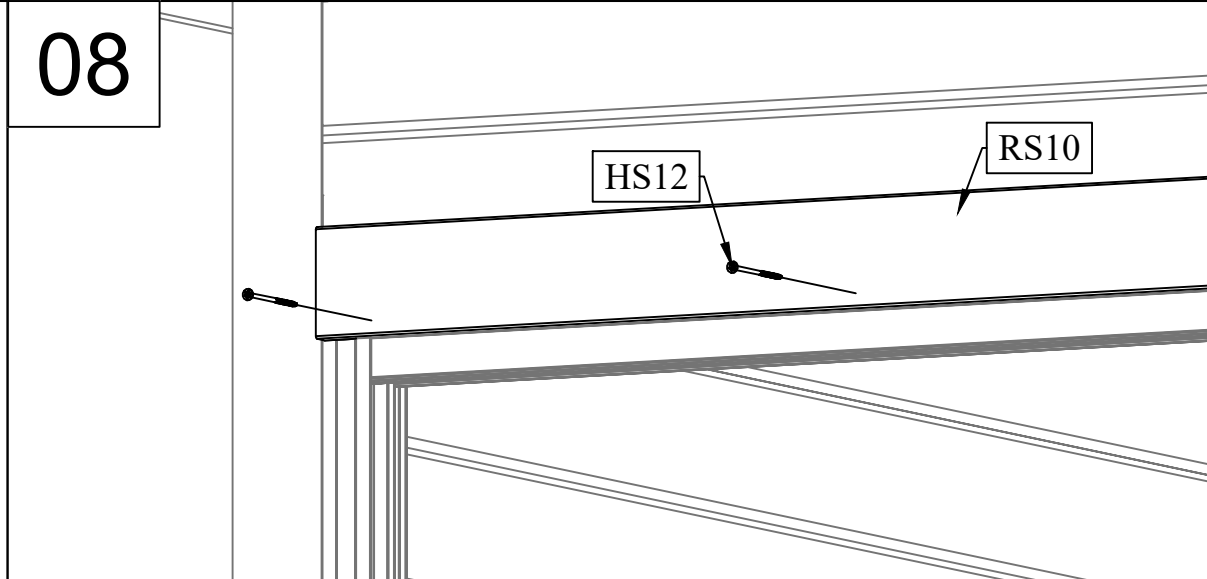
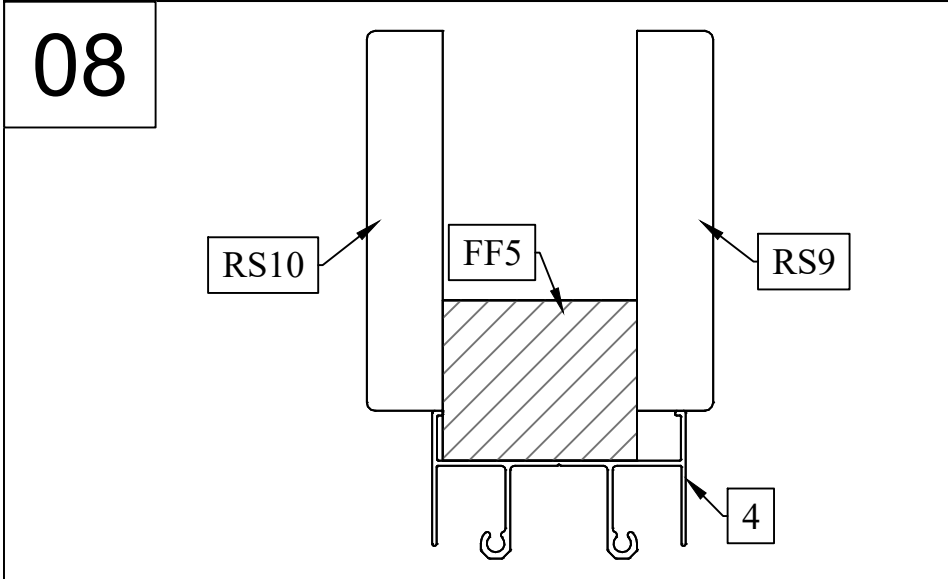
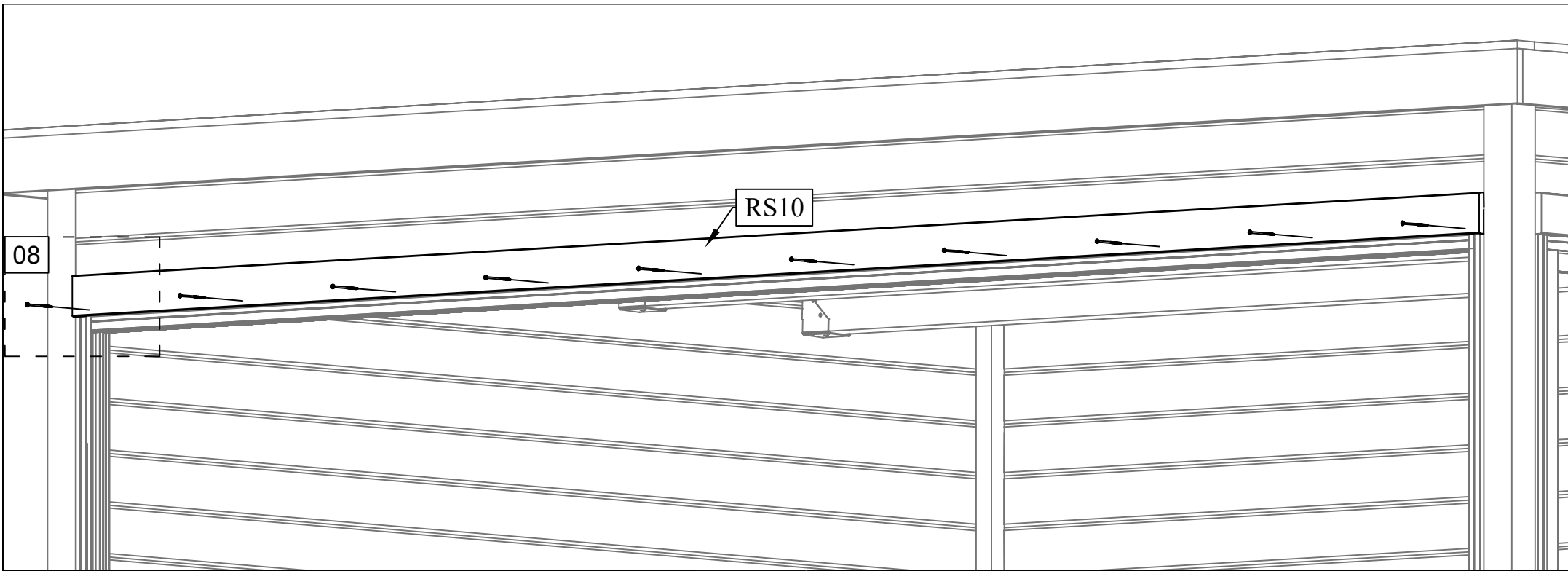

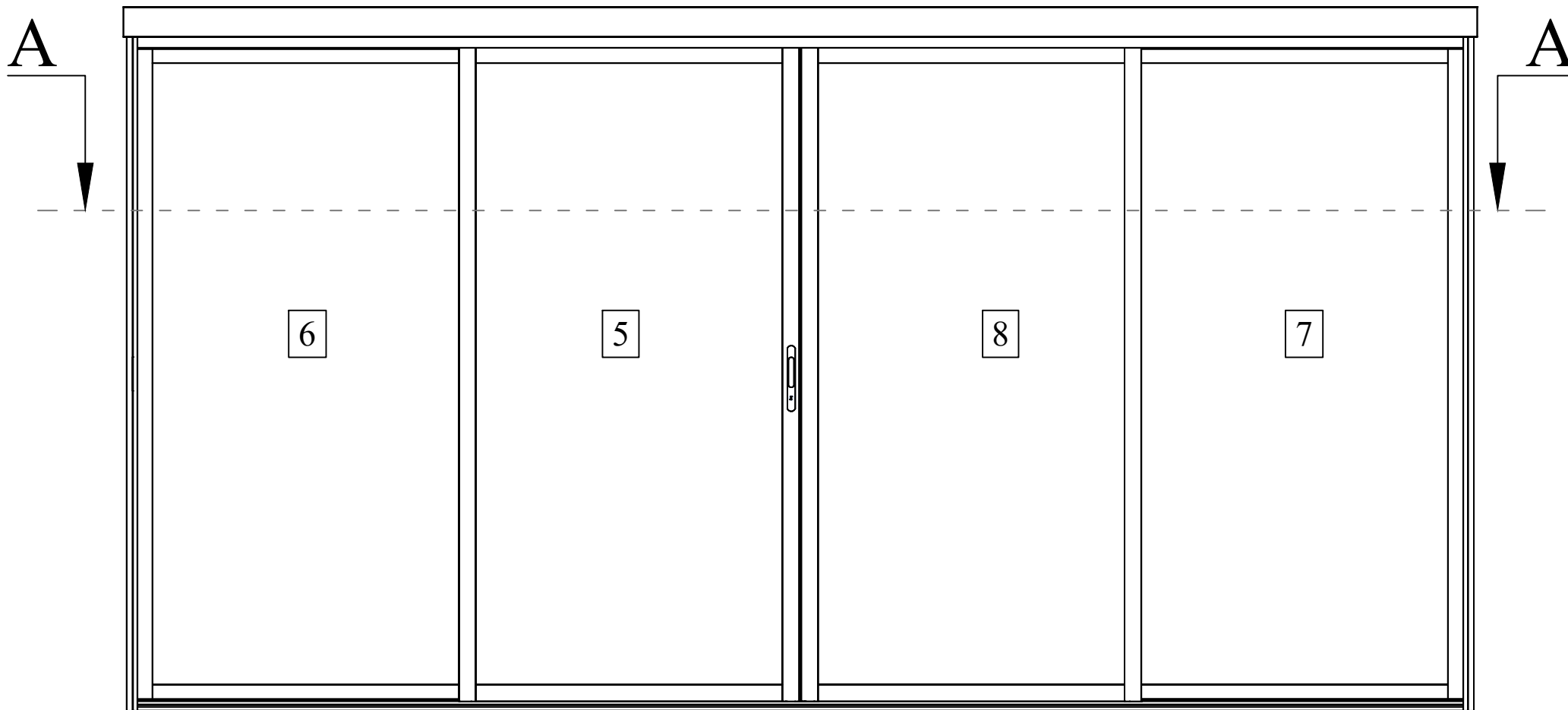

A-A

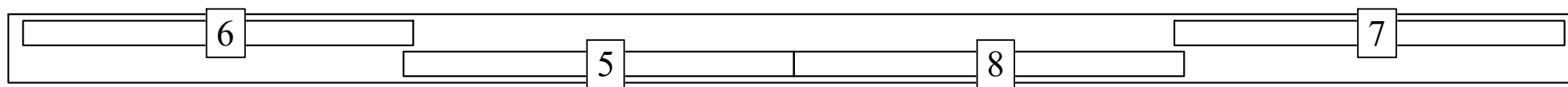

09

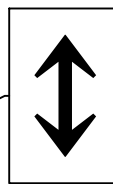
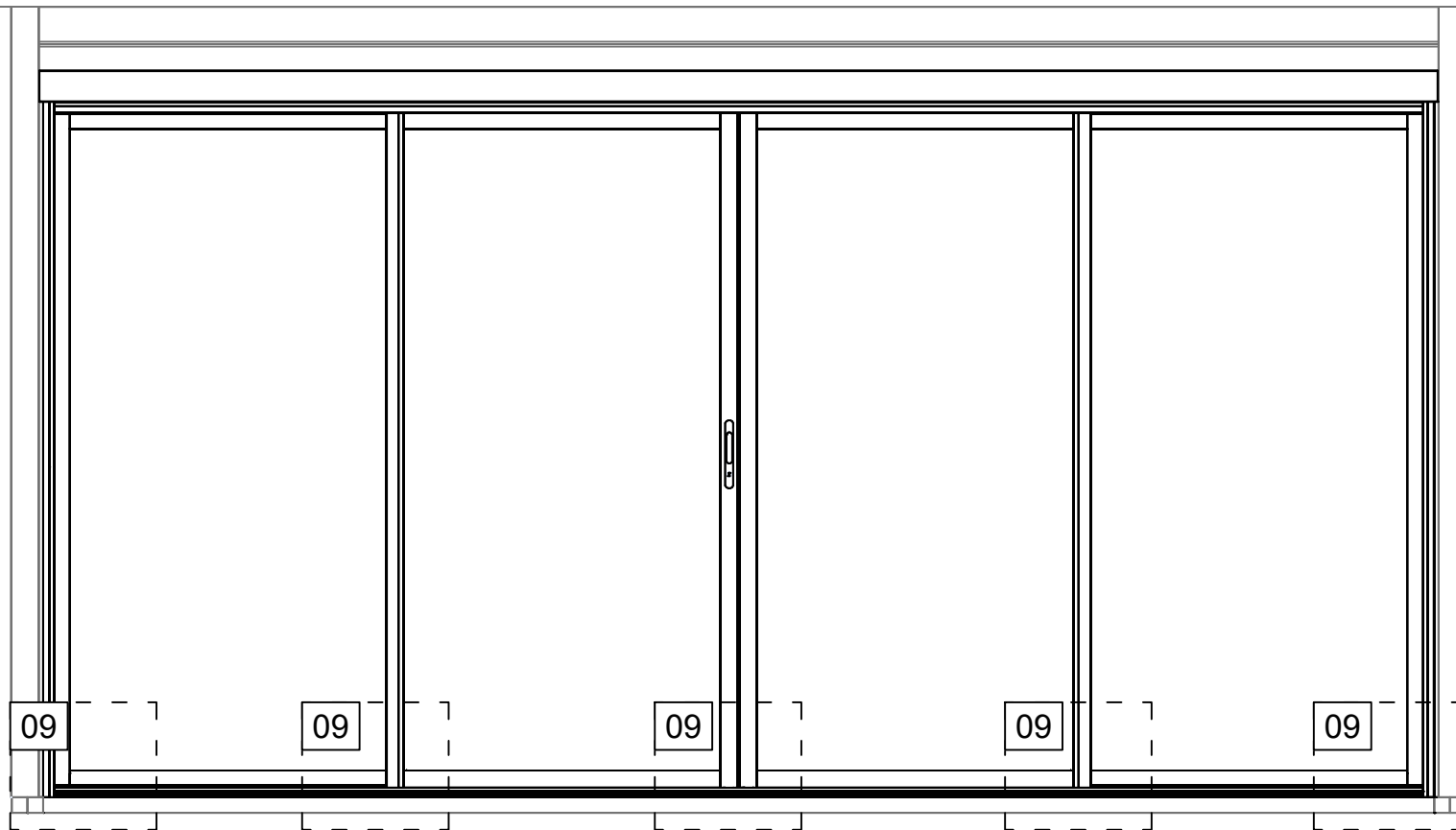





$$A=B$$

