

980721

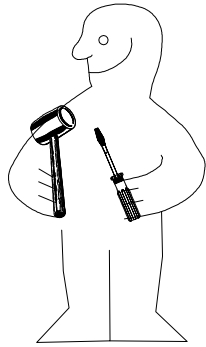

1.



2.

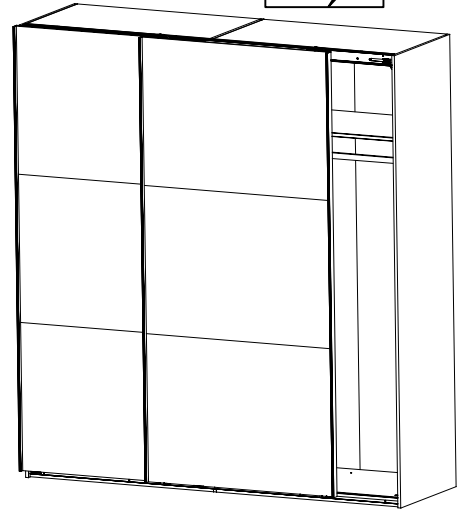
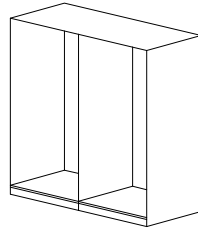



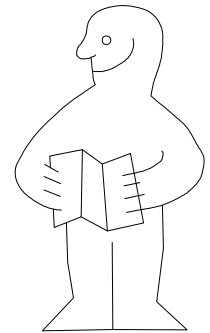
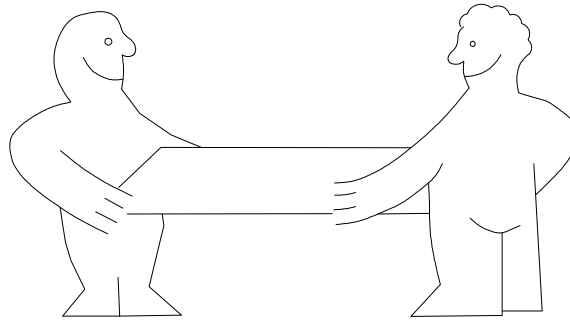
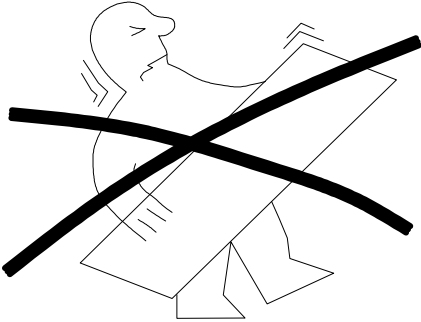

HSP 200

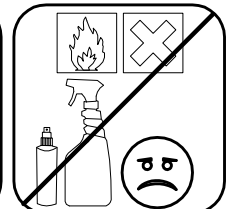
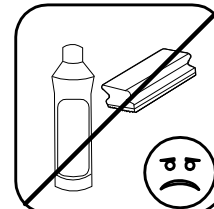
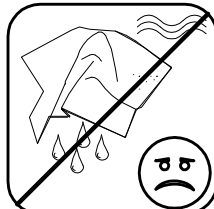
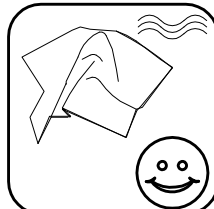
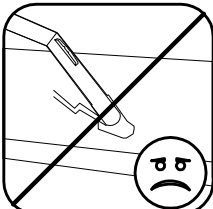
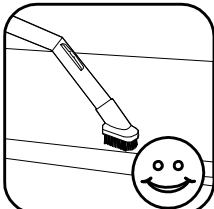
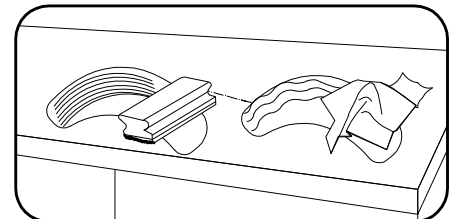
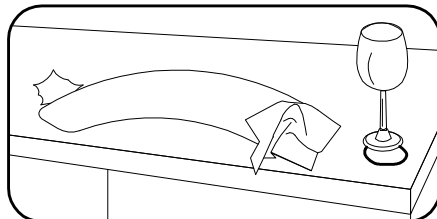
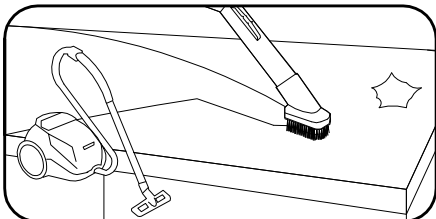
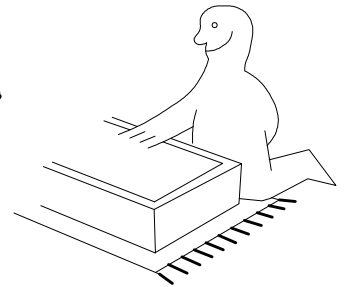
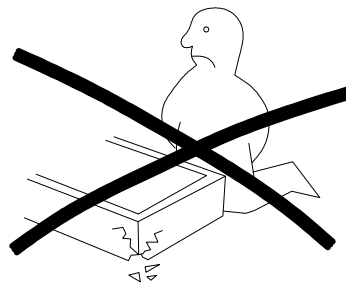
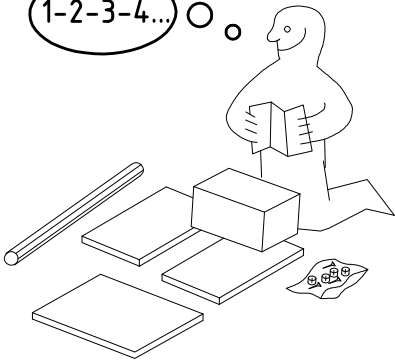

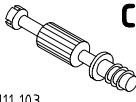



1-2-3-4... ○



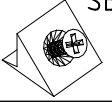

 111 xxx	A1	16x
 111 103	C	8x
	F3	4x

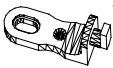
 111 xxx	S0	10x
 111 xxx ø12	V12	10x
 121 370 3,5 x 15 mm	G1	28x



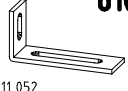

 117 002	K2	4x
 100cm	SBV	16x
 112 400	K10	2x

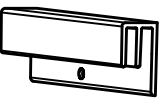

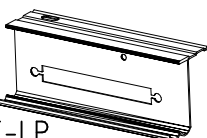
 111 611	J2	6x
 112 055 6,3 x 10,5 mm	T1	24x
 111 607	L8	8x

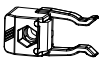
 111 052	o10	1x
 121 120 4 X 15mm	SP15	3x

1x   
FPK  
1453/1940/2430/2920/3408

1x   
SWT-LP  
1453/1940/2430/2920  
/3410 SY

 121 xxx	SWT-ST	2x
 121 xxx M4 x 13 mm	SWT-SM5 GH13	2x
 121 xxx M4 x 10 mm	G43	4x
 121 xxx 3,5 x 35 mm	G14	4x
 121 375	G14	2x

 121 004	SWH-SKL	1x
 121 004 3,5 x 22 mm	SWH-SKR	1x
	G24	7x

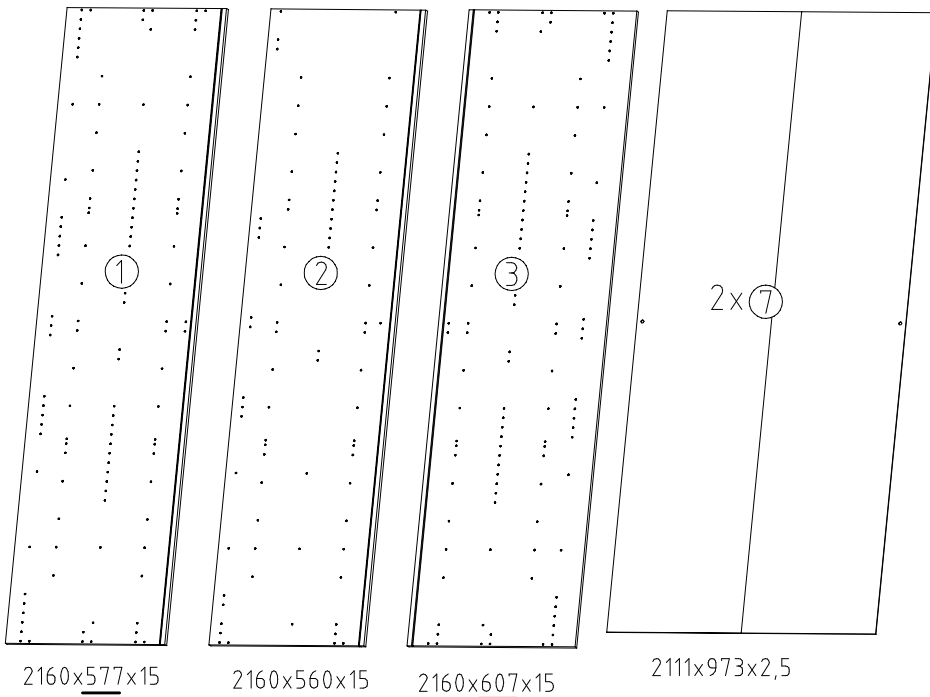
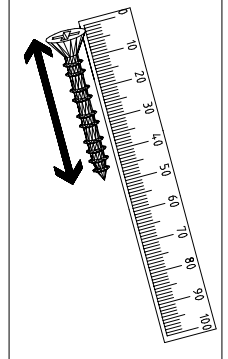
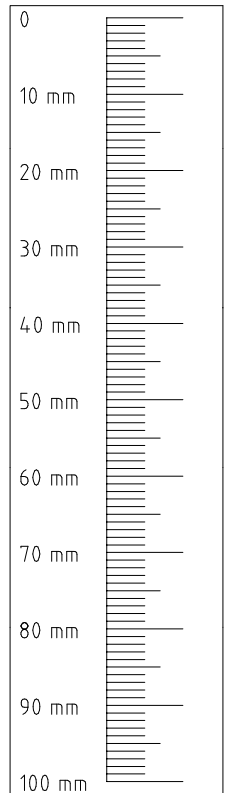
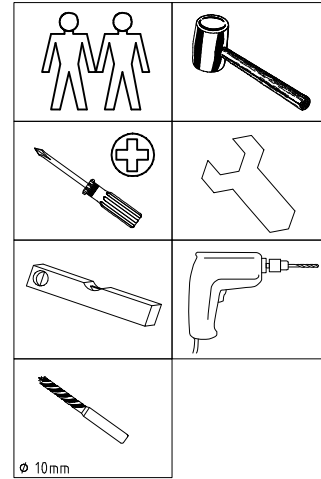

1

3,5 x 15 mm

G1

S0

A1

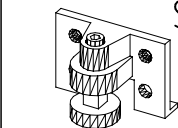
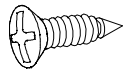

121 370

111 xxx

111 xxx

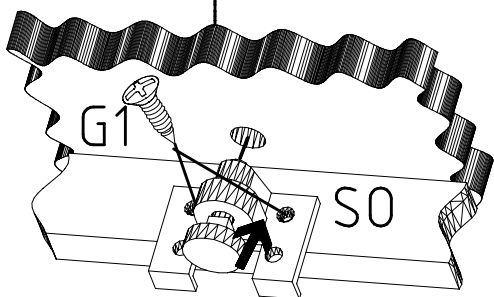
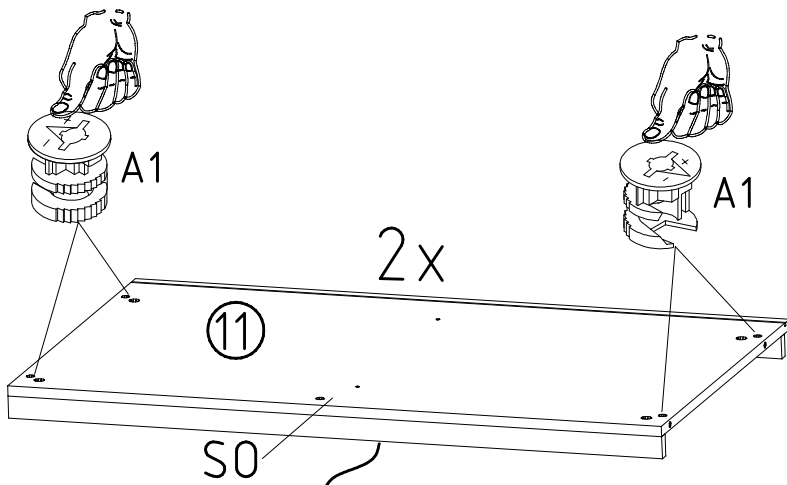

3

F3

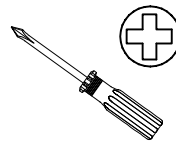

6,3 x 10,5 mm T1

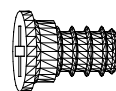

112 055

3,5 x 15 mm

G1

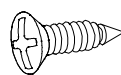

121 370

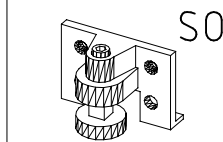

111 xxx

F3

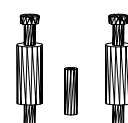

2

A1

111 xxx

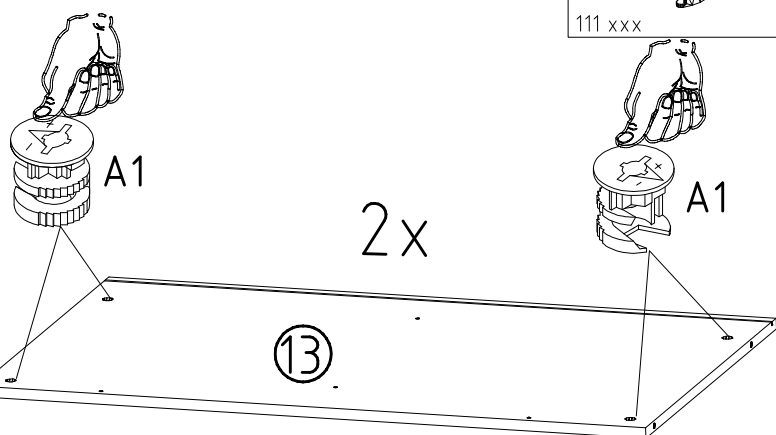

S0

S0

F3

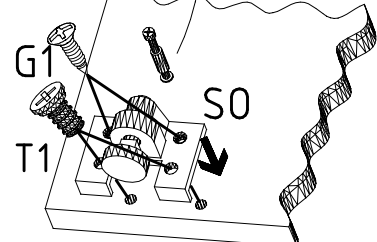
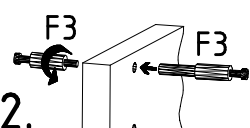
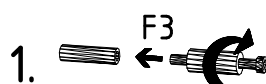

4

SWH-SKL

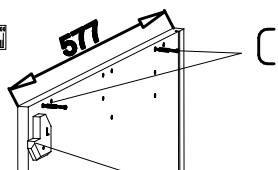
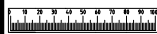
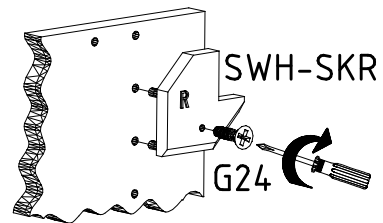
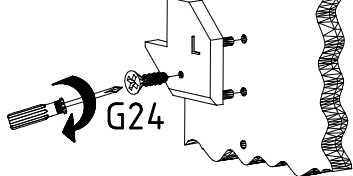

SWH-SKL + G24

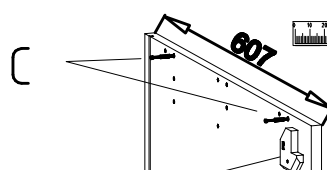
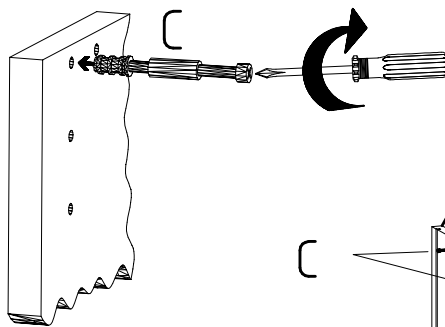

SWH-SKR + G24

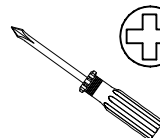
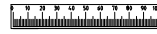

SWH-SKL

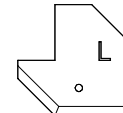

SWH-SKR

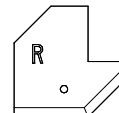

3,5 x 22 mm G24

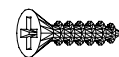

121 004

6,3 x 10,5 mm T1

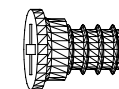

112 055

3,5 x 15 mm G1

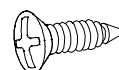

121 370

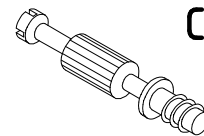

111 103

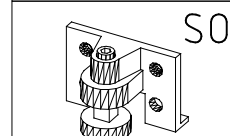

111 xxx

1

3

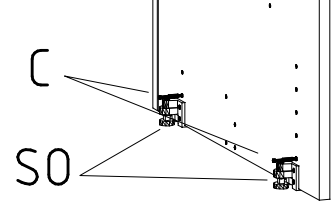
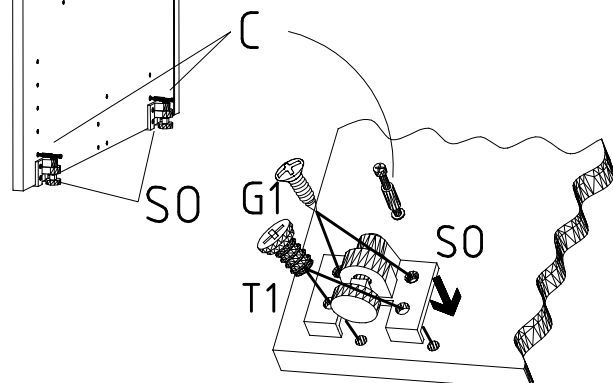

5

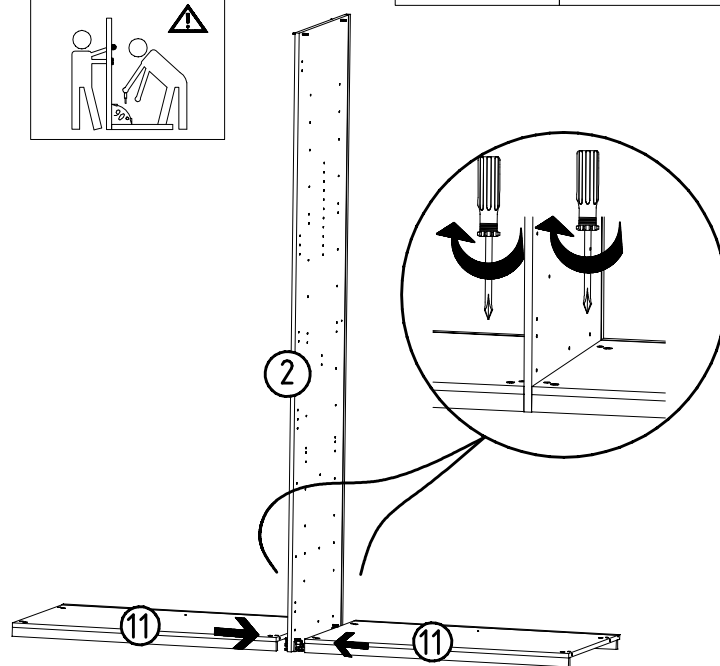
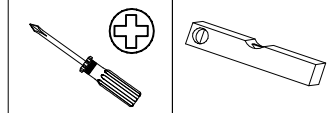

6

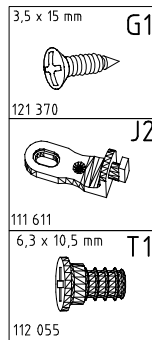
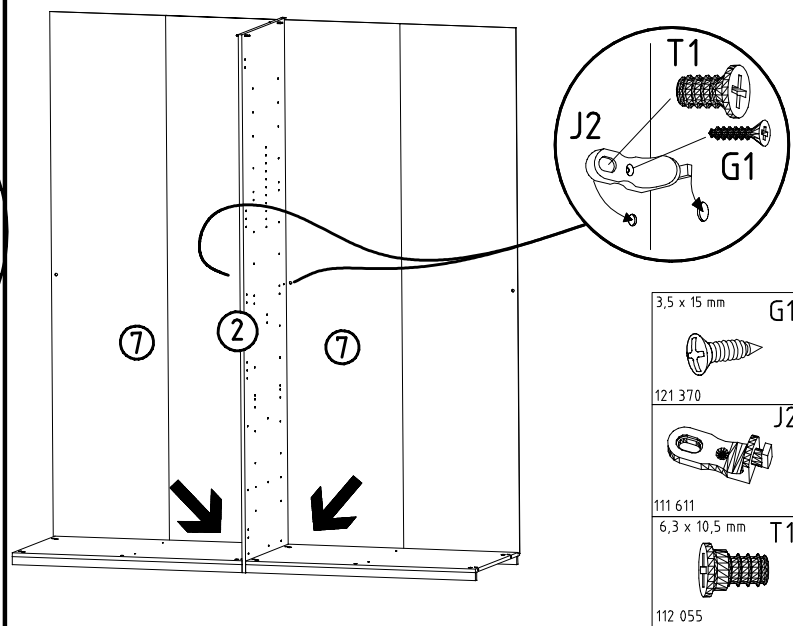
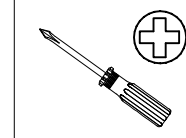

7

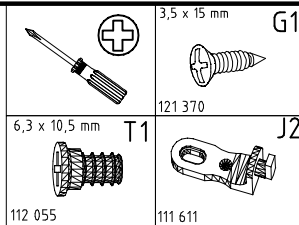

8

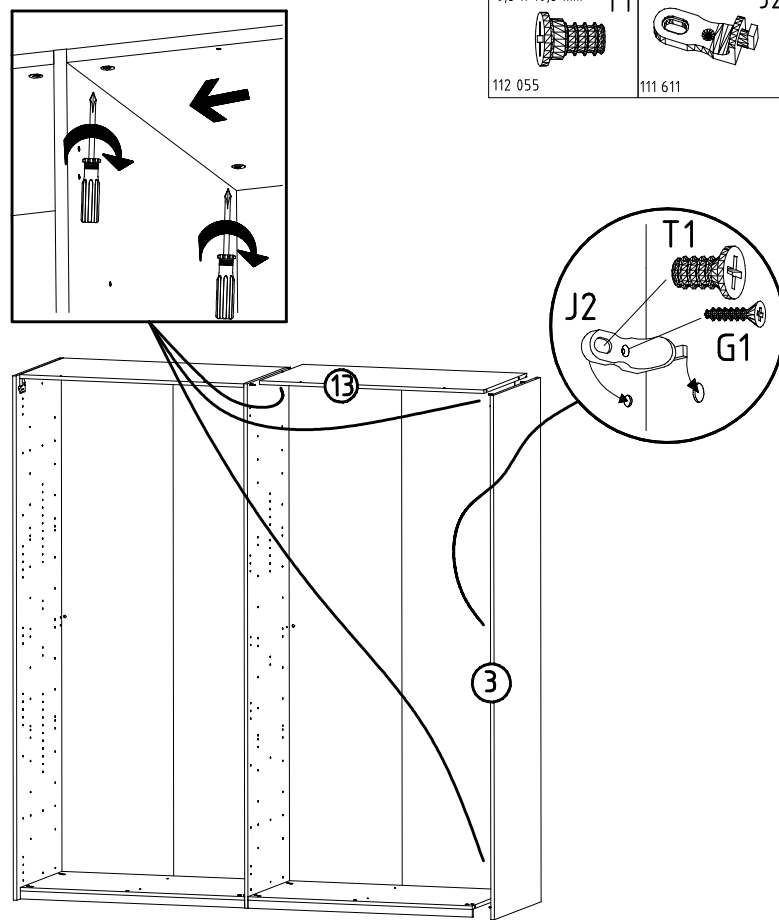
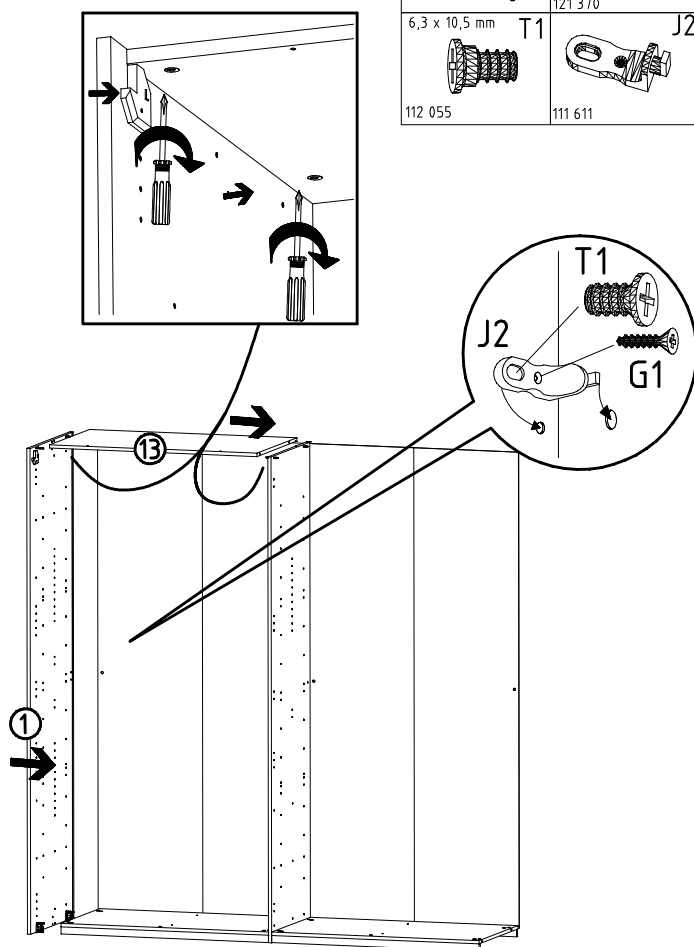
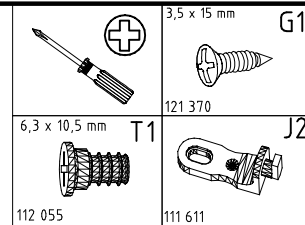

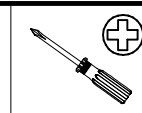

111 607



117 002

3,5 x 15 mm

K2

G1

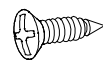

121 370

K10

100cm

112 400

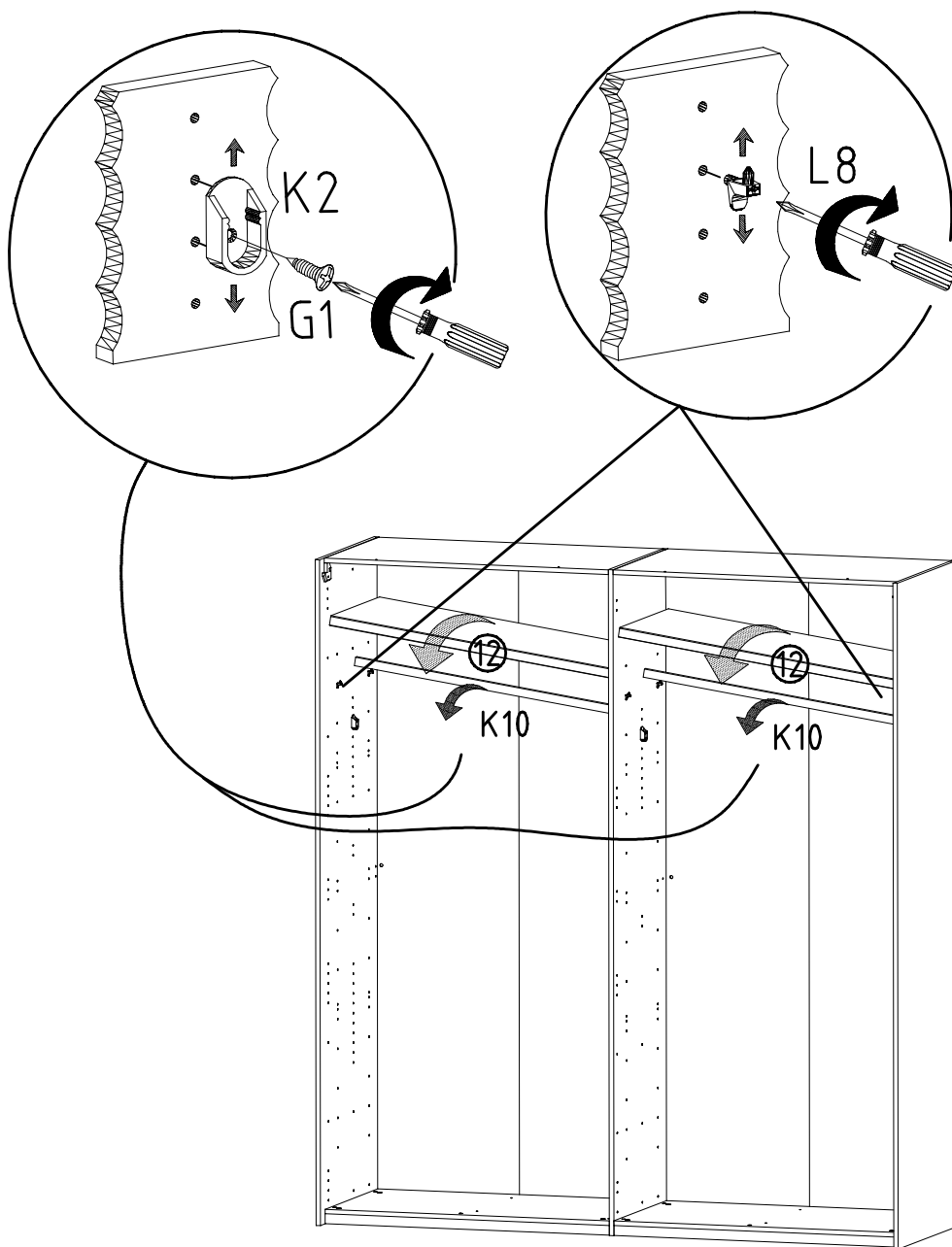

10

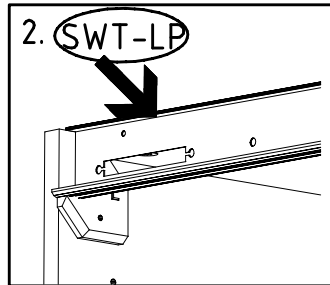
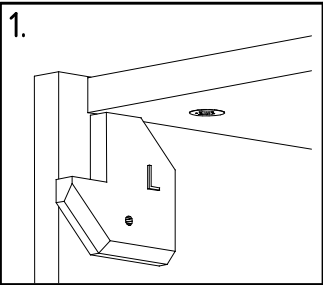

M4 x 10 mm G43 121 xxx	M4 x 13 mm GH13 121 xxx	3,5 x 35 mm G14 121 375	SWT-ST 	SWT-SM5 
------------------------------	-------------------------------	-------------------------------	------------	-------------

SWT-LP  
1453/1940/2430/2920  
/3410 SY

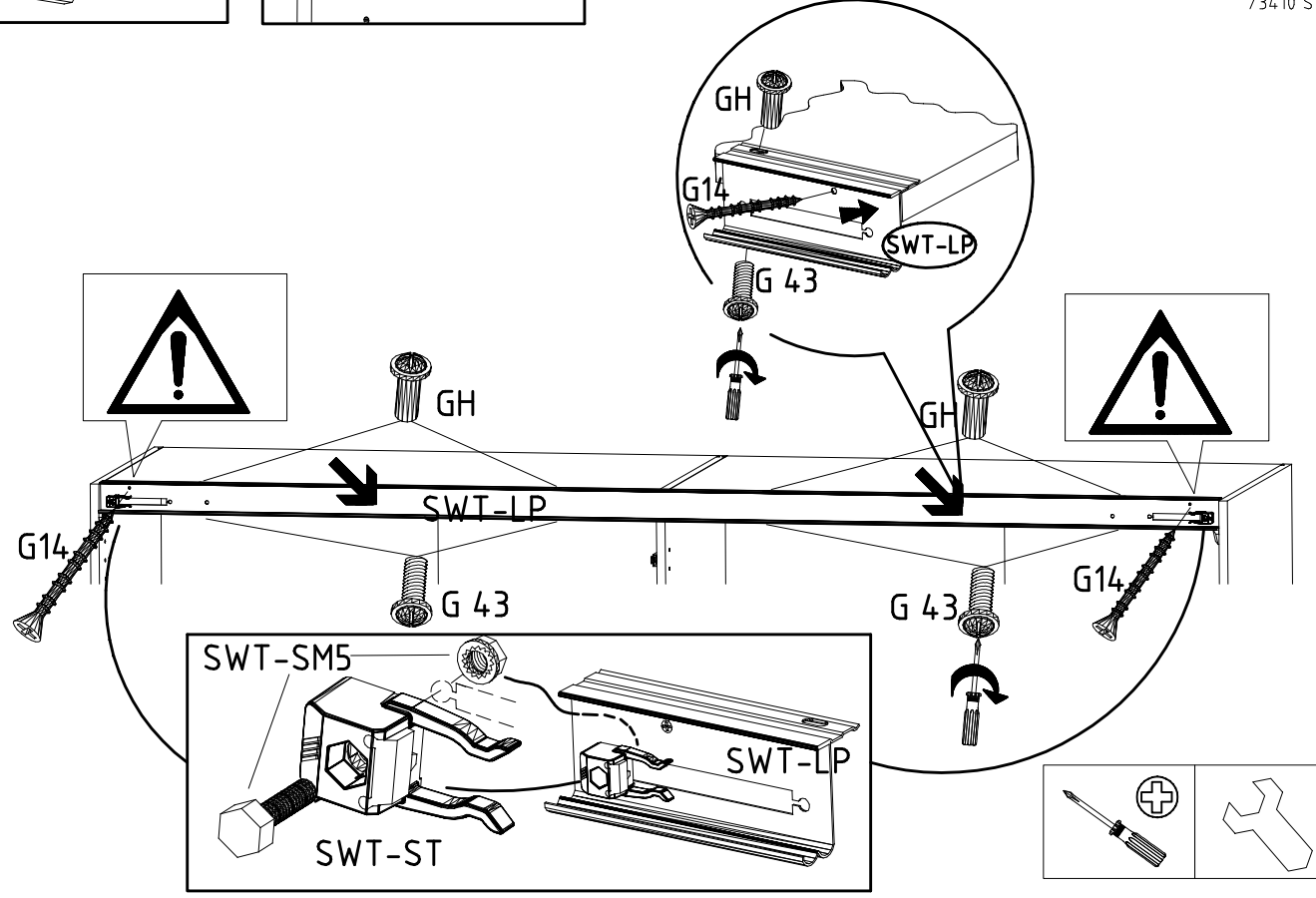

11

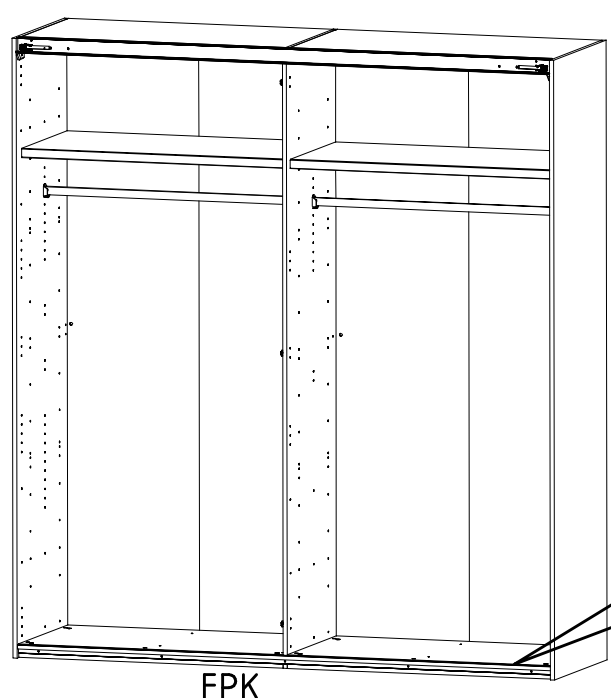

**FPK**  
1453/1940/2430/2920/3408

3,5 x 22 mm **G24**  
121 004

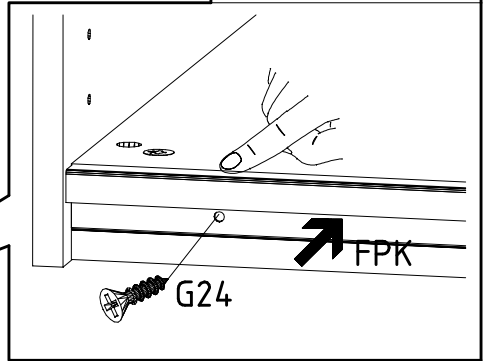

12

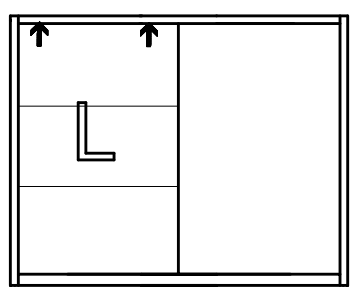
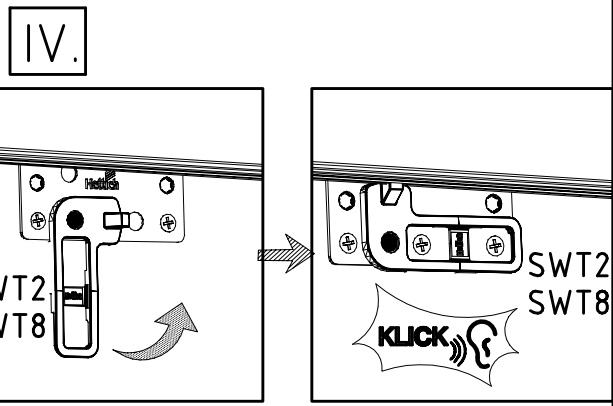
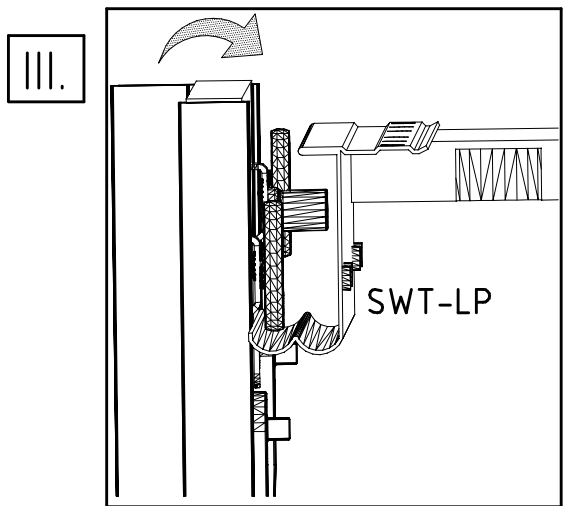
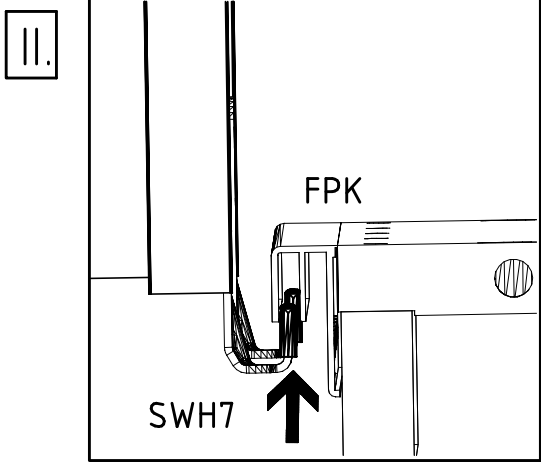
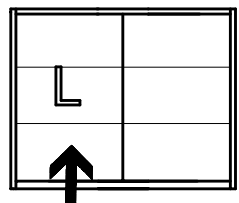
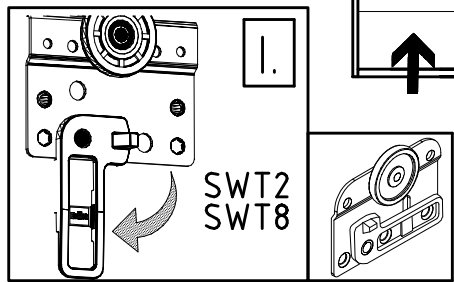

13

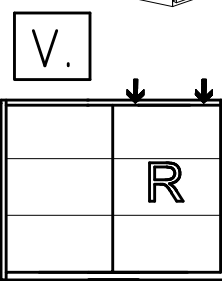
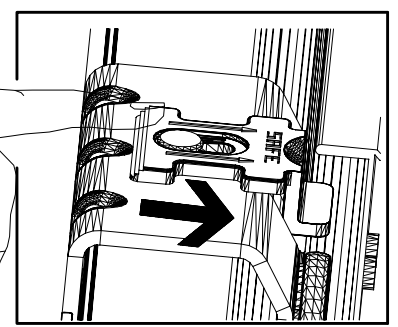
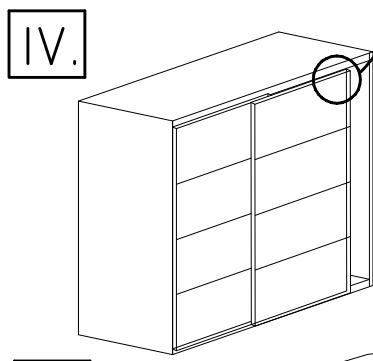
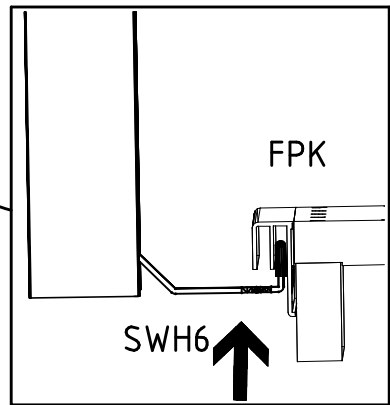
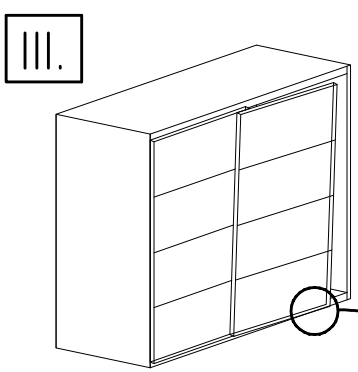
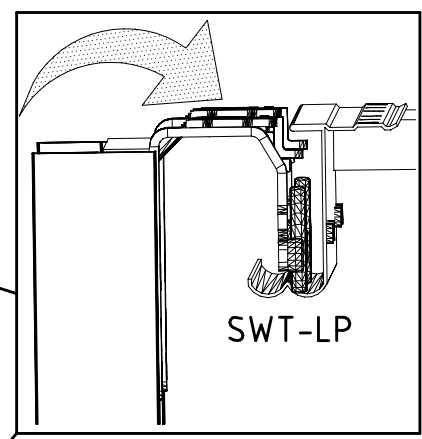
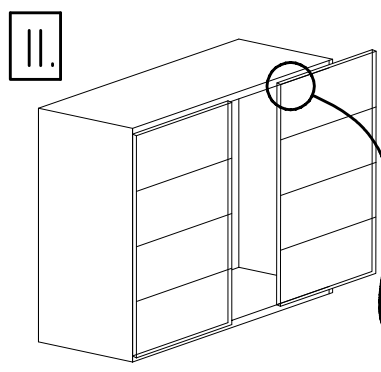
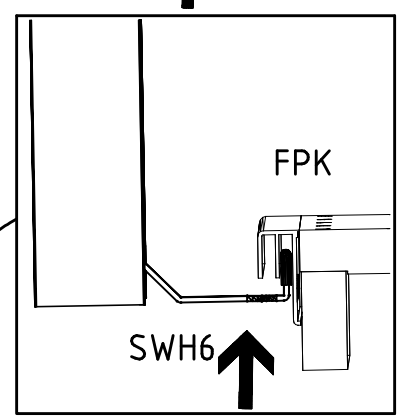
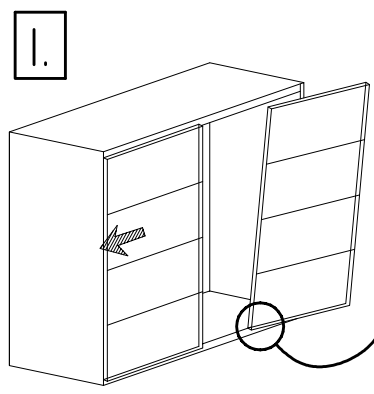
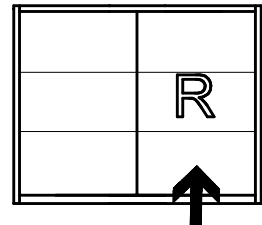
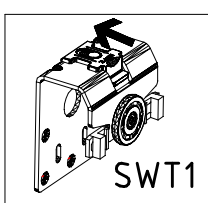



14

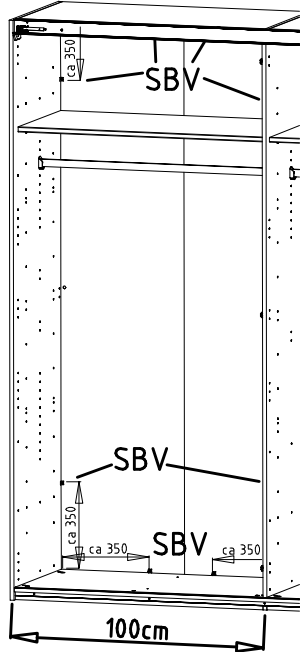
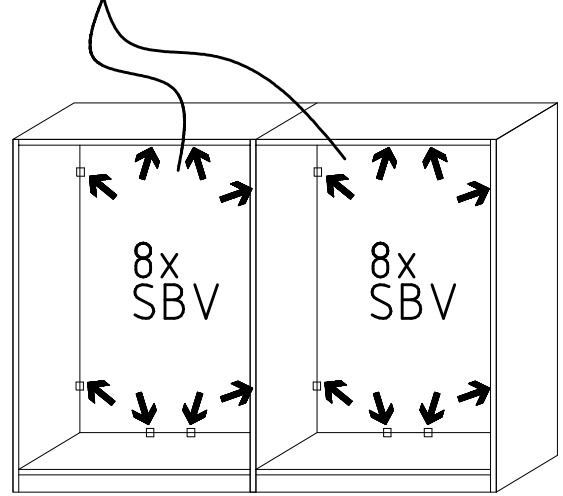
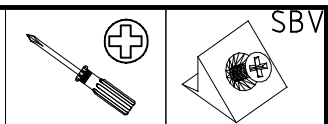
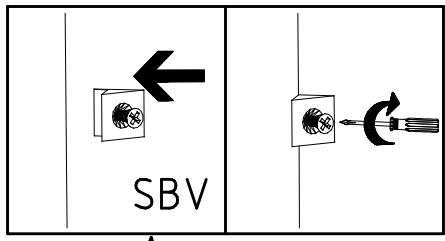

15

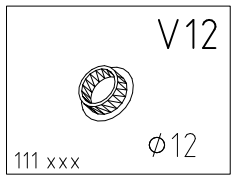
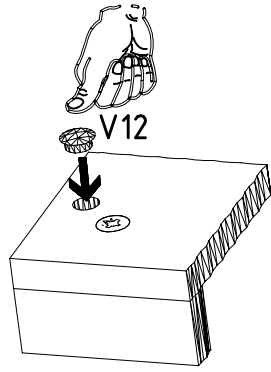
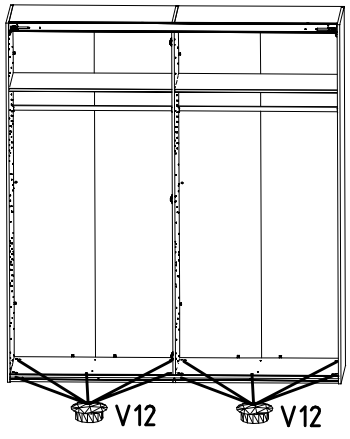

16

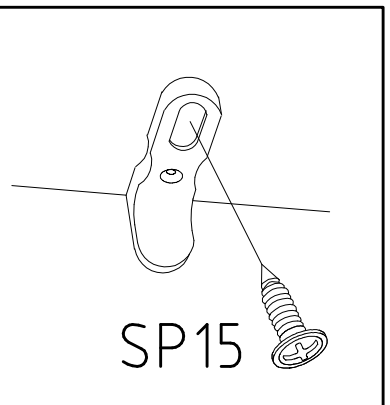
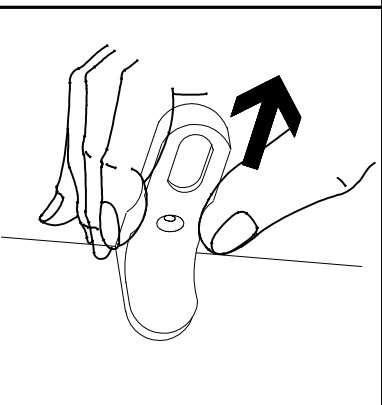
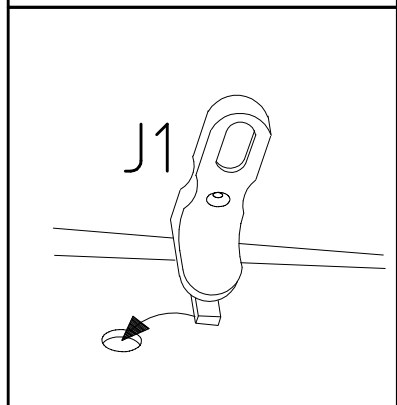
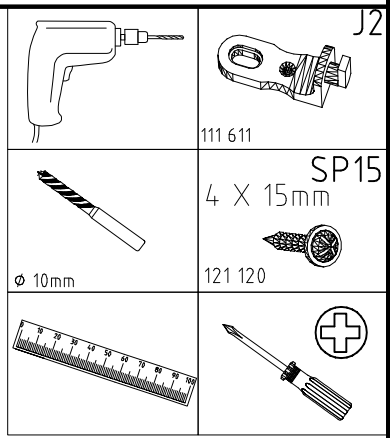
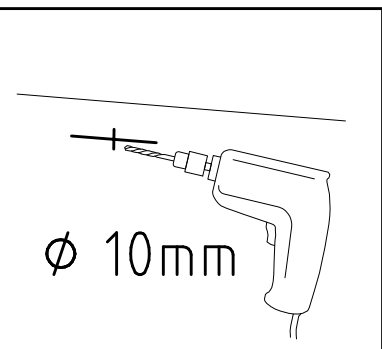
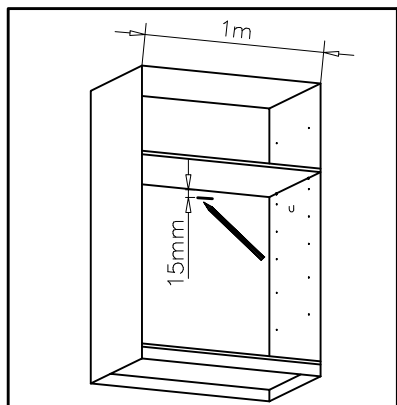

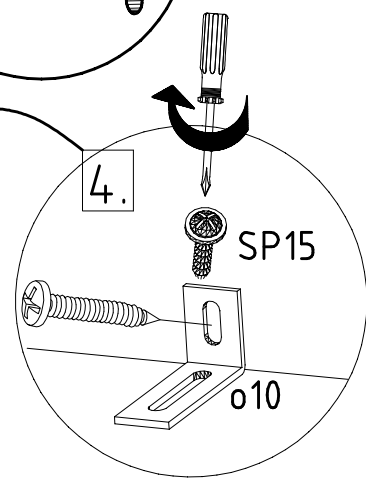
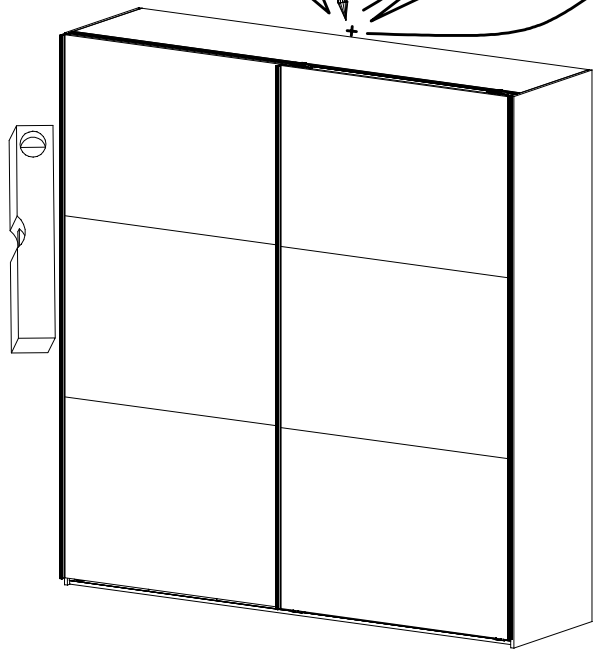
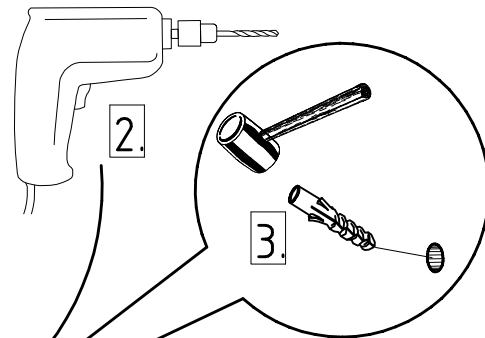
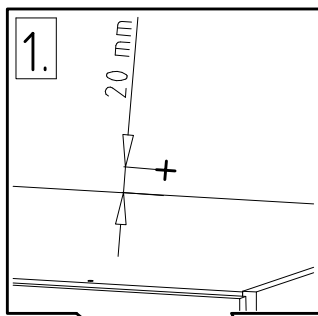
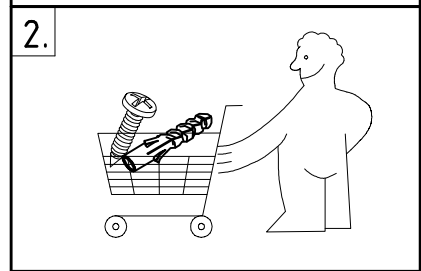
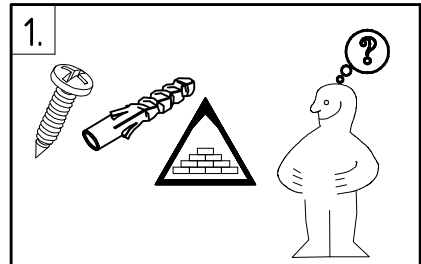
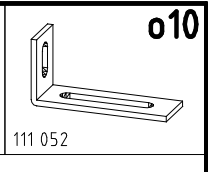
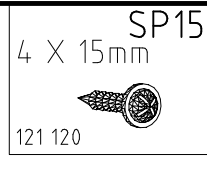
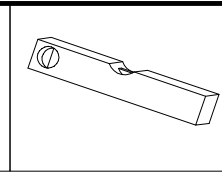
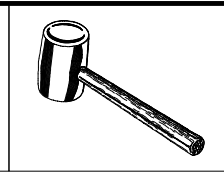
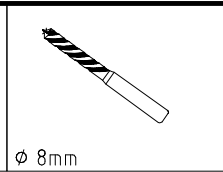
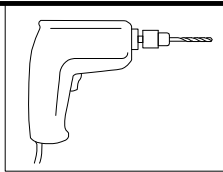

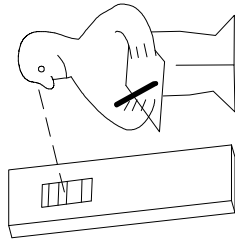
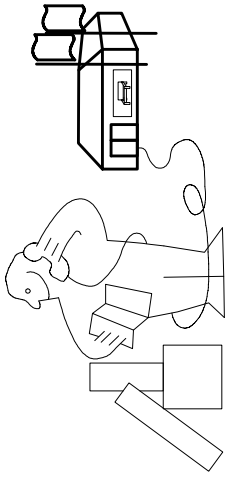
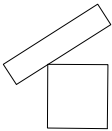
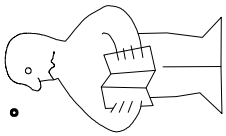

Modell/Model/Modèle

\_\_\_\_\_  
\_\_\_\_\_  
\_\_\_\_\_



\_\_\_\_\_  
\_\_\_\_\_  
\_\_\_\_\_  
\_\_\_\_\_  
\_\_\_\_\_

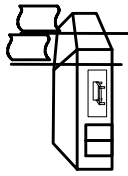

\_\_\_\_\_  
\_\_\_\_\_  
\_\_\_\_\_  
\_\_\_\_\_

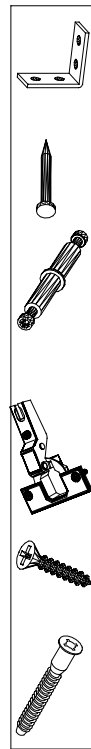

{121 370}	{ G 1 }	{4x}

Änderungen die dem technischen Fortschritt geschuldet sind, behalten wir uns vor !

Bei nicht vorschriftsmäßiger und/ oder nicht fachmännischer Montage wird bei Personen- und/ oder Sachschäden keinerlei Haftung übernommen.

WIMEX Wohnbedarf/ Import Export Handels GmbH/ Postfach 1407/ 49112 Georgsmarienhütte/ Germany  
Tel.:(+49) 054-01 8598 16/17 Fax.:(+49) 054-01 8598 33 Mail: service\_H@wimex-online.com

104P-Nr. / 104P-No.    150X-Nr. / 150X-No.    Auftrag/Order-No. / No. de Commande

**23203**    **30110XY**    104

Kunde    MAX MUSTERMANN  
Customer  
Client

Kommission / your order reference / votre reference

**3377 MINDEN**

---

Dekor / Decor    Decor / Modell / Modele

**F99**    **SAMPLE**

F99842    SCHWEBETUERENSCHRANK 250 CM H 216CM  
PLANKENEICHE NB + RAH STEEL  
PLANKENEICHE NACHBILDUNG

202320301107241476000001

Paket / Package / Paquet

**414760**

SOCKEL

Paket 1 von 8    Colli Kommission 10

HSP-SHT BOD 50 TEXT/TEX SOCKEL 32 FRESH    TV / LF 104  
SO-BOD TEXT RASTEX/ ZNBOD D18MM TX KLSTA

Montage - Anleitung    Laenge ..... 520,0    OBEREN  
KS-64    Breite ..... 568,0    OBEREN

**SOCKEL32 KLEB**

En cas de dommage, veuillez retourner le carton avec le produit. / En cas de dommage, veuillez retourner le carton avec le produit.



OBEREN 5 30/19 HAUT 23.08.19 OBEREN 1 1. JABOVE OBEREN

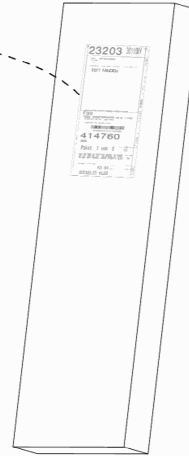

**WIMEX Wohnbedarf**  
Import Export Handelsges mbH & Co. KG  
Werner-von-Siemens-Str. 35  
D-49124 Georgsmarienhütte - Germany

**SAMPLE**    **23.08.19**  
Modellname    Produktionsdatum  
Model    Date of manufacture

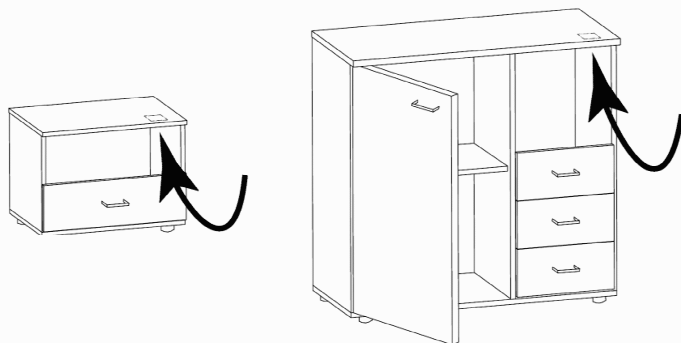
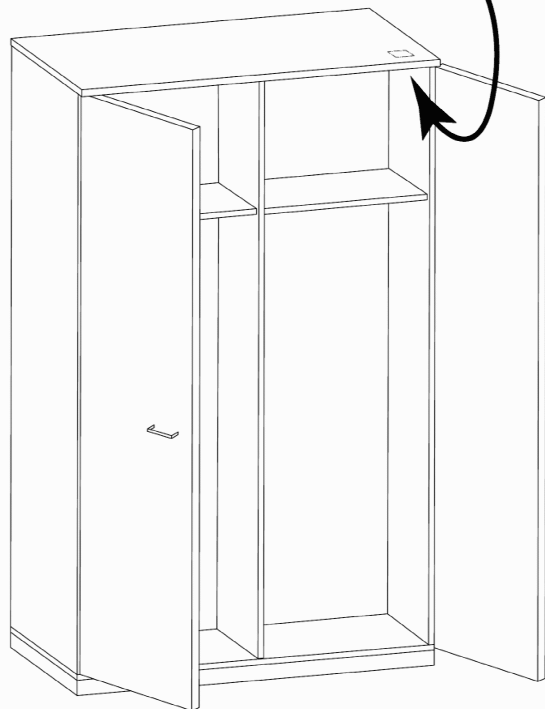
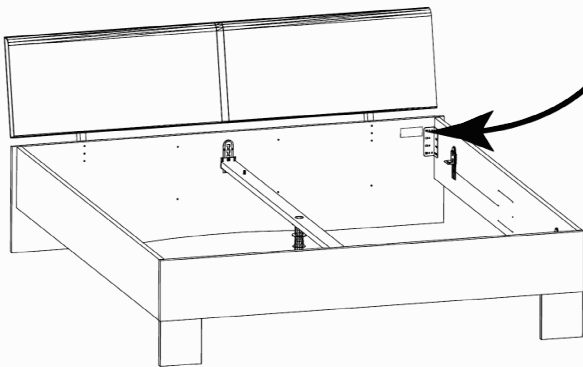

980830



1.

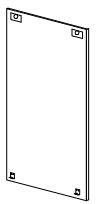

2.

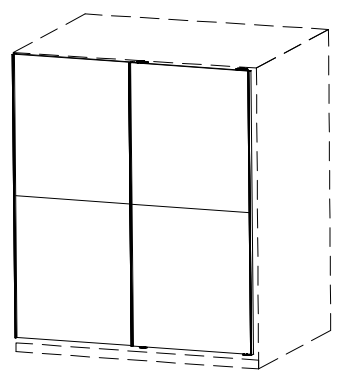
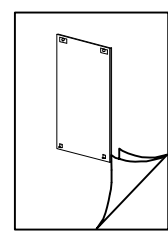
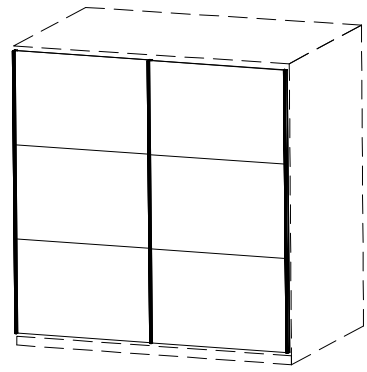
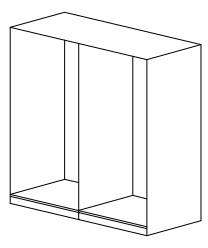
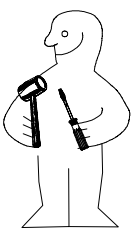

150/200/250/300 HSP

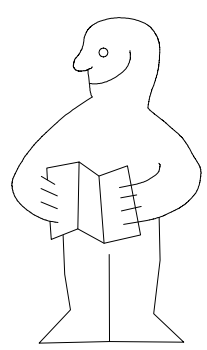
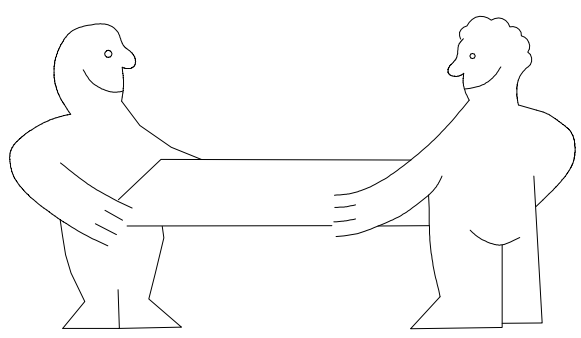
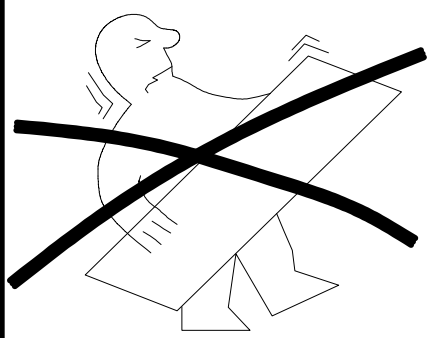

1-2-3-4... ○

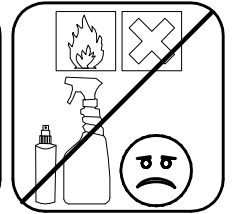
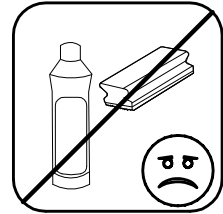
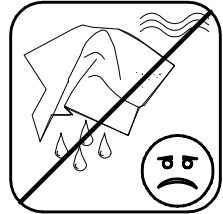
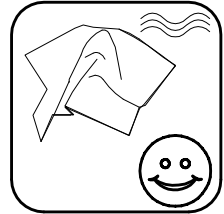
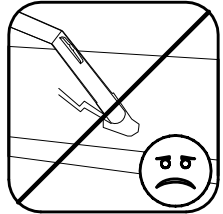
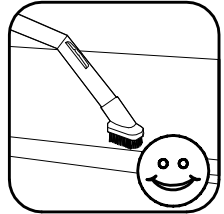
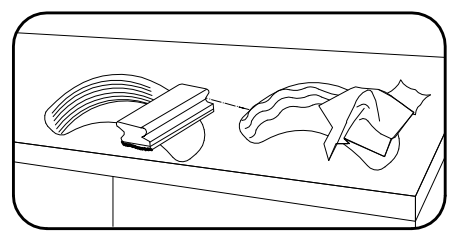
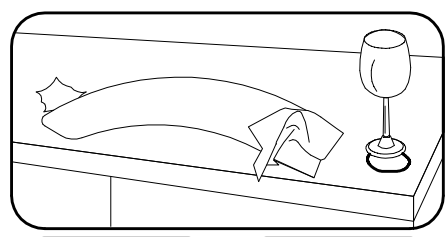
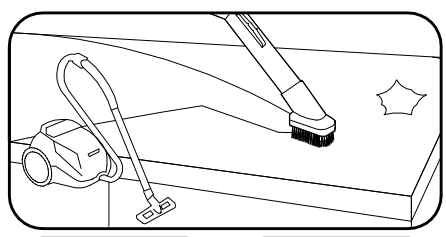
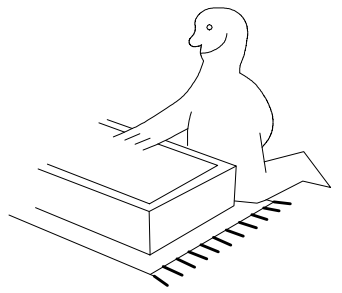
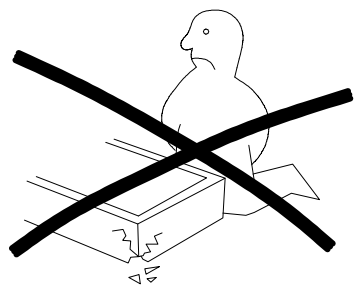
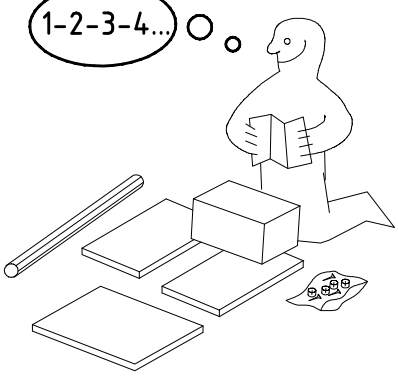



980830

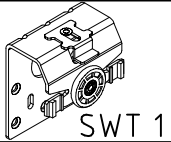
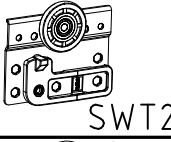
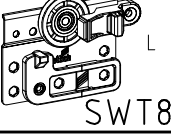

26.11.16 / -

11 16

1/11

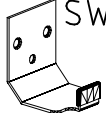
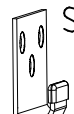
 SWT 1	2x
 SWT 2	1x
 SWT 8	1x

3,5 x 15 mm  G1 121 370	1x
 SWH 6	2x
 SWH 7	2x

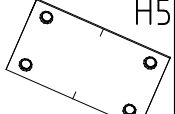
4 X 13mm  SP13 121 122	60x 68x
6,3 x 10,5 mm  T2 111 030	24x
 H5 114 183	2x 4x

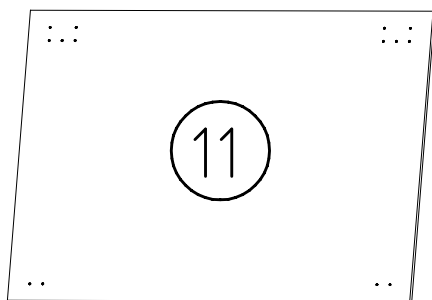
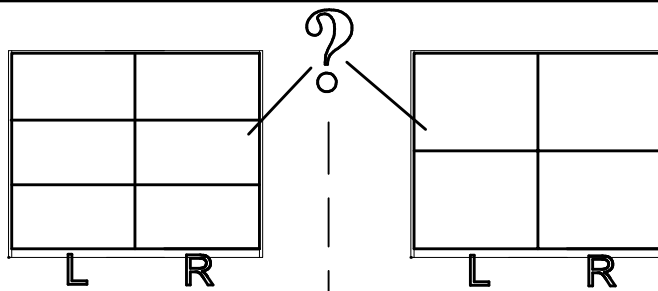
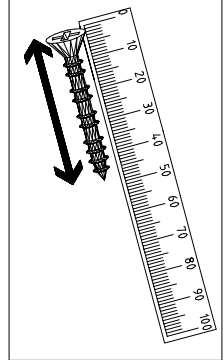
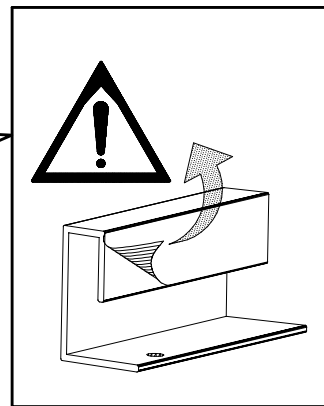
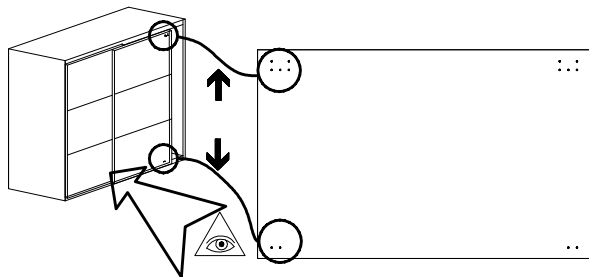
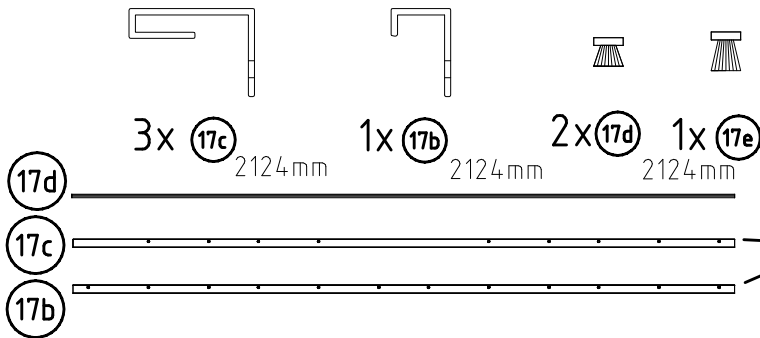
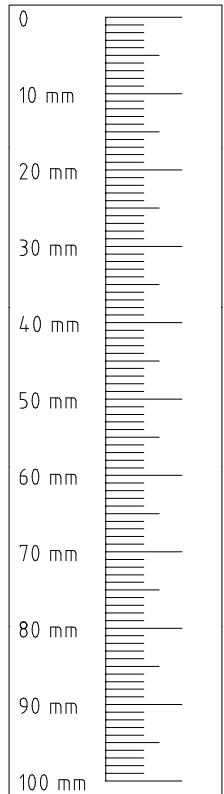
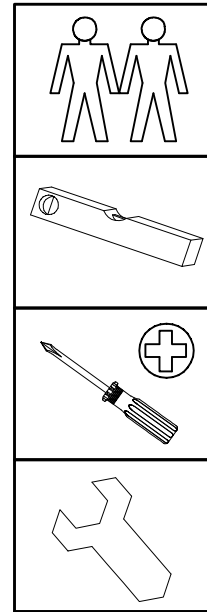

6x 745/990/1235/1485 x 708 x 15

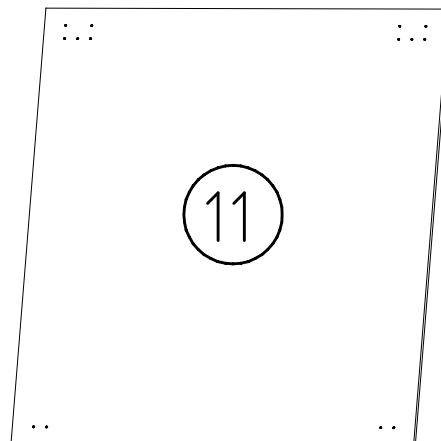
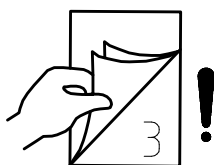

4x 745/990/1235/1485 x 1062 x 15

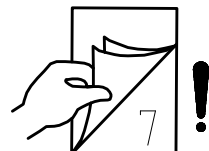

1

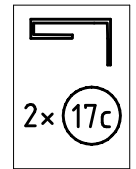
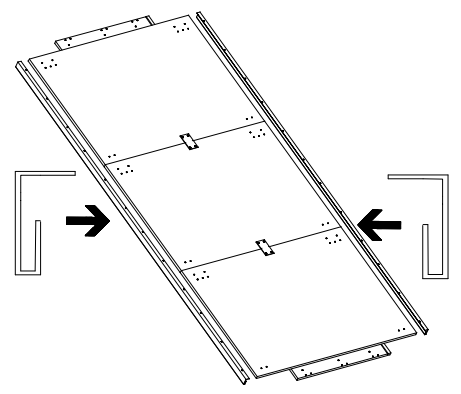
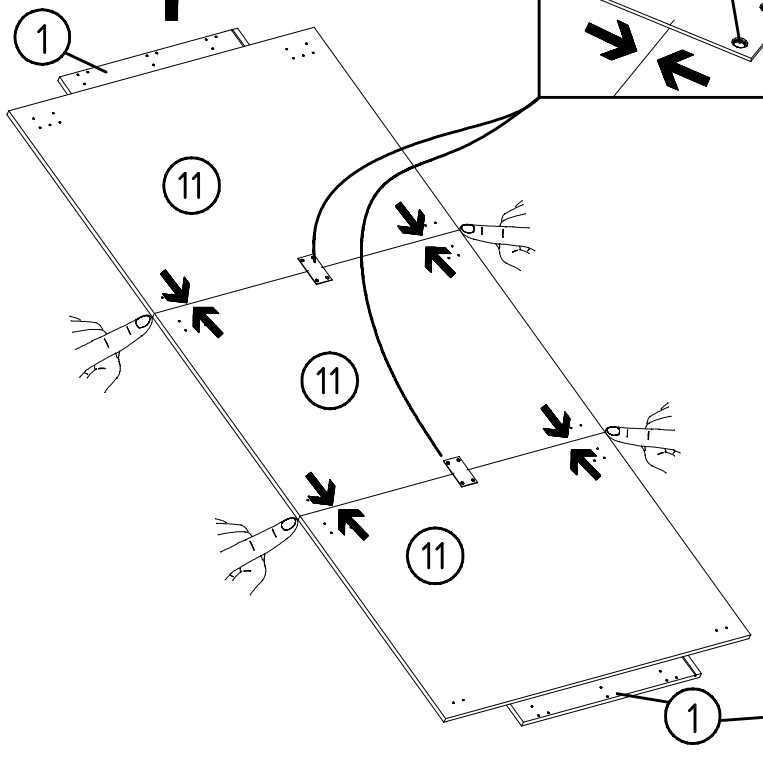
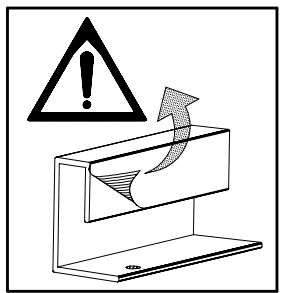
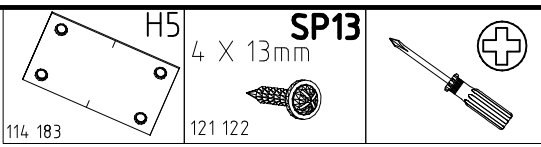
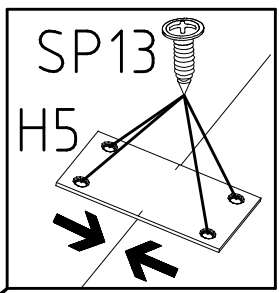
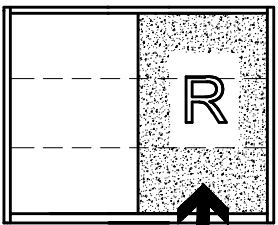

2

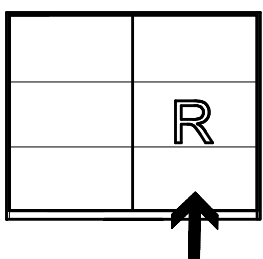
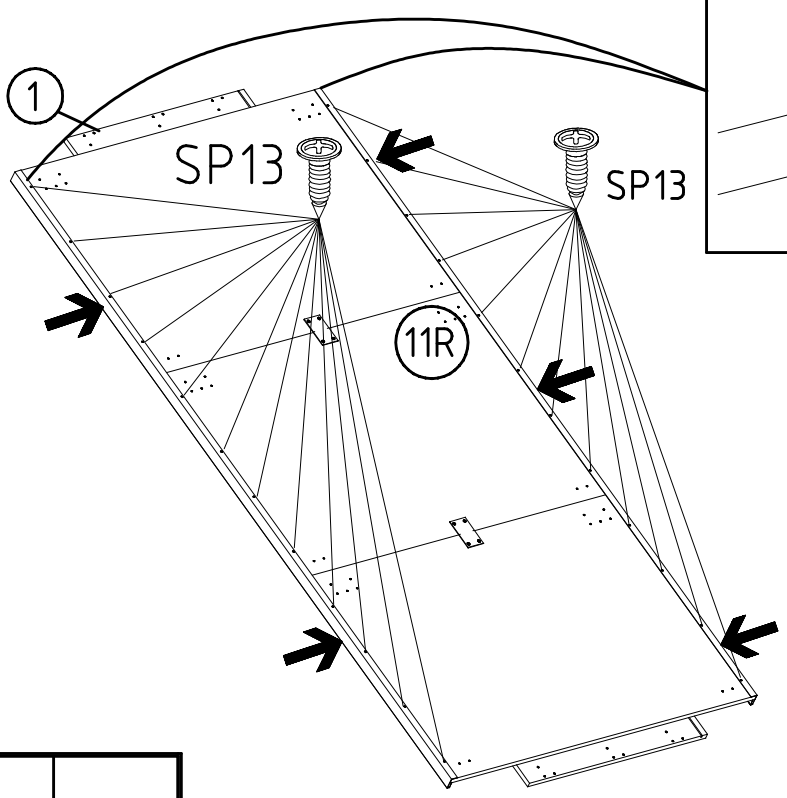
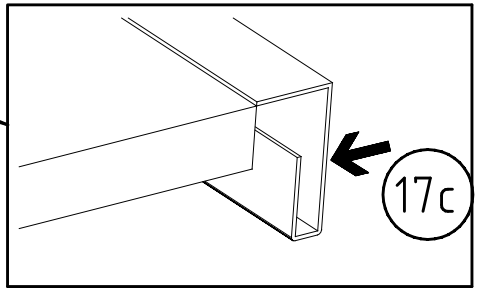
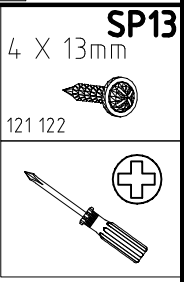

3

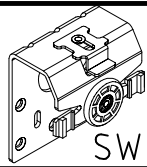

SWT 1

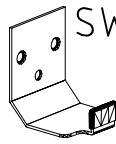

SWH 6

4 X 13mm

121 122

SP13



6,3 x 10,5 mm T2

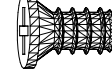

111 030

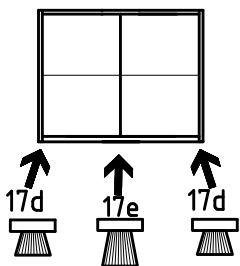
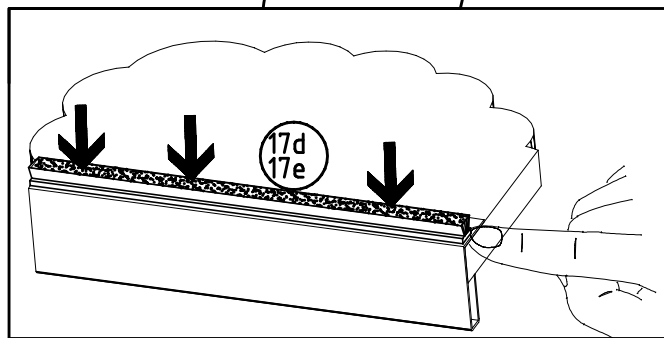
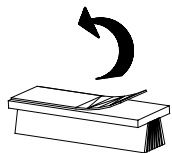
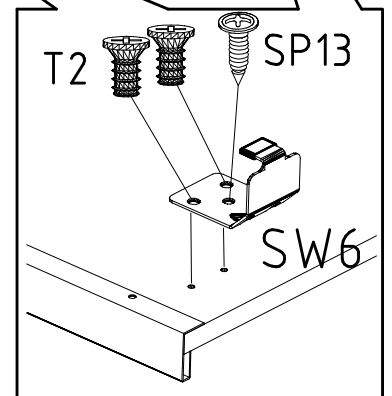
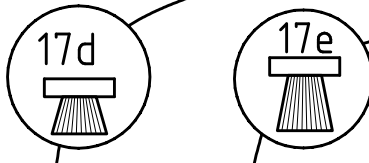
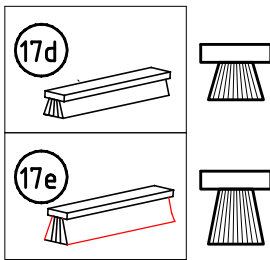
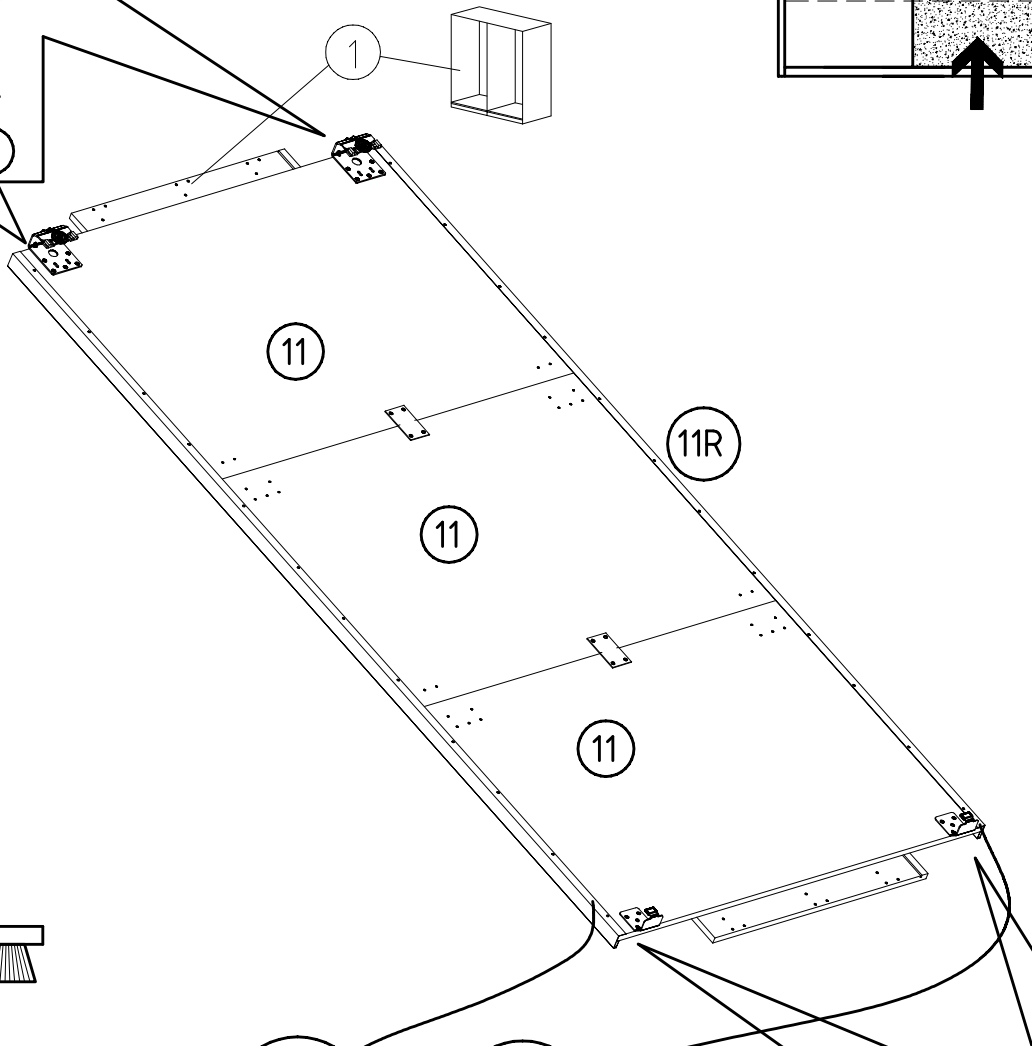
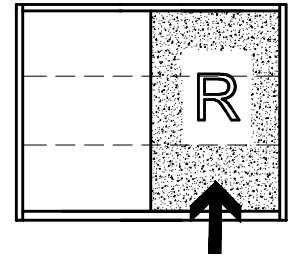
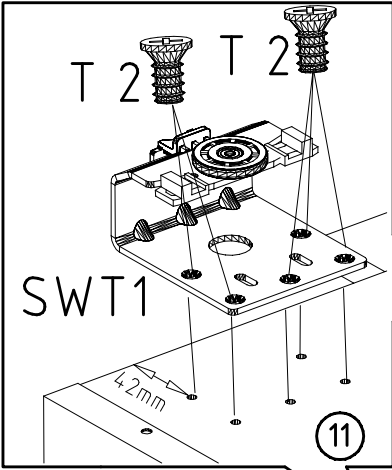
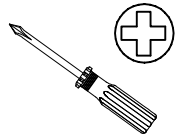



4

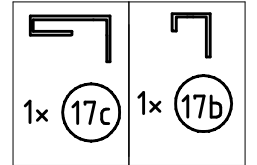
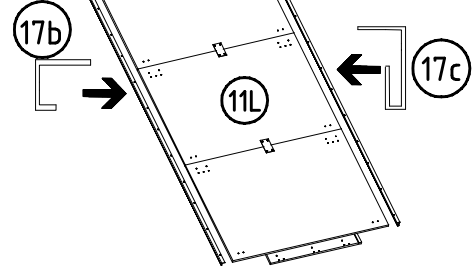
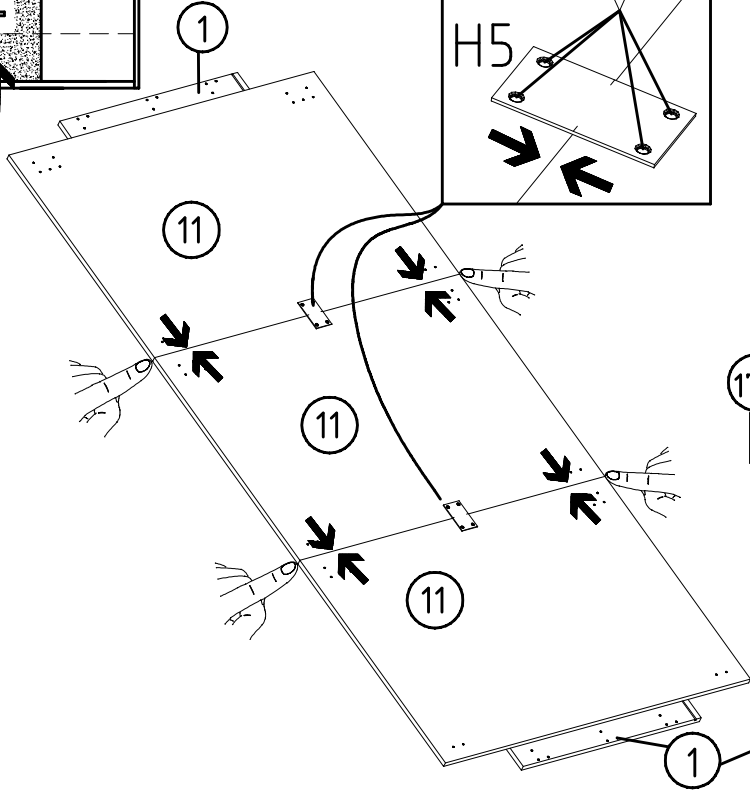
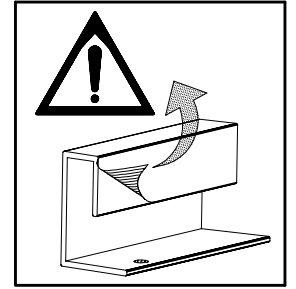
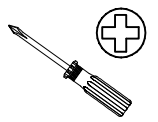
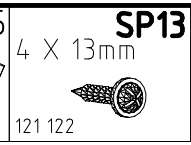
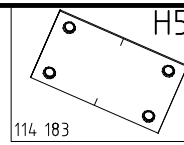
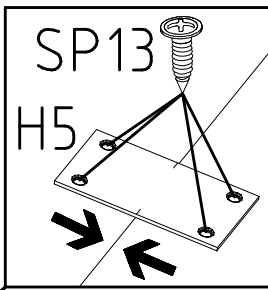
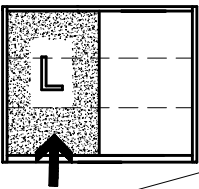

5

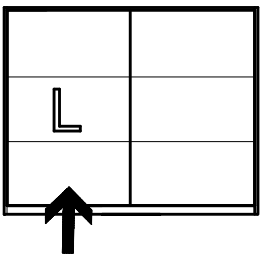
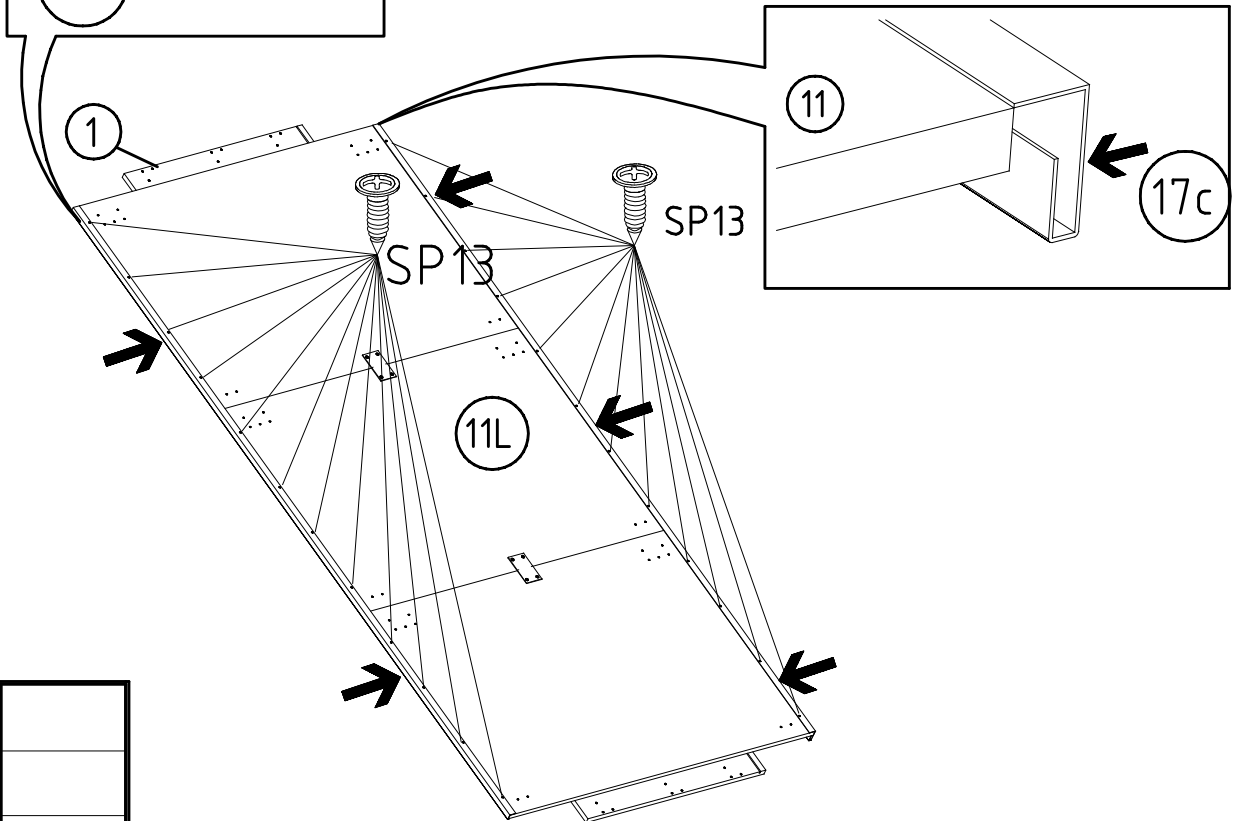
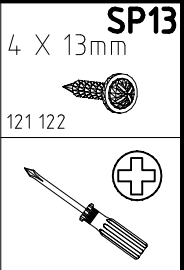
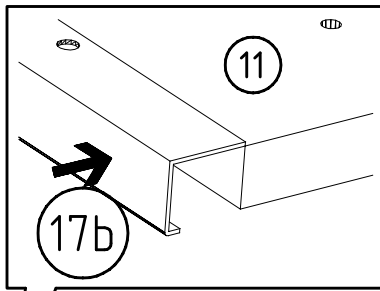

6

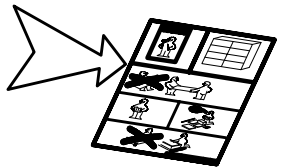
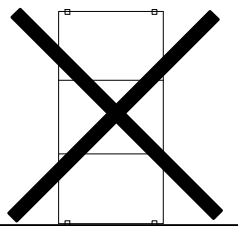
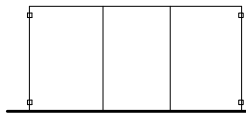
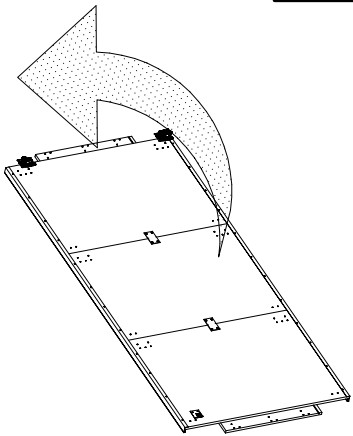
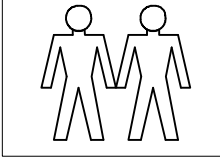
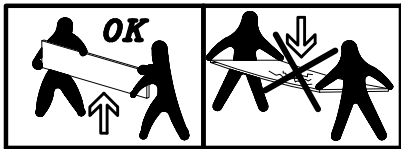
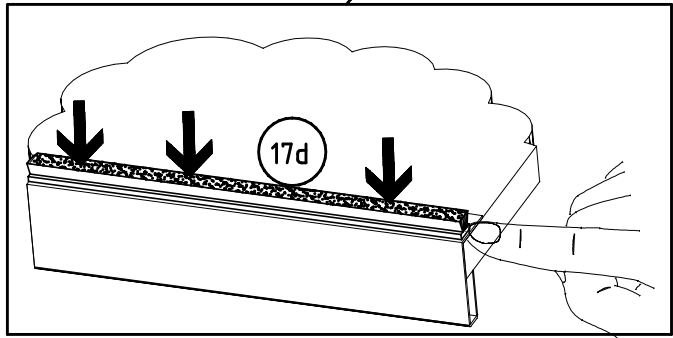
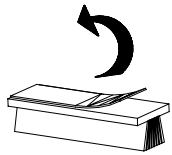
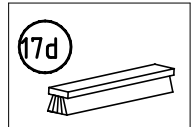
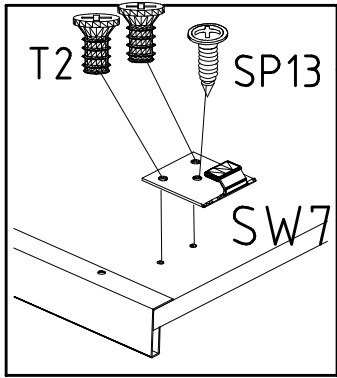
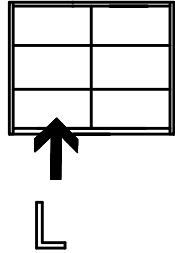
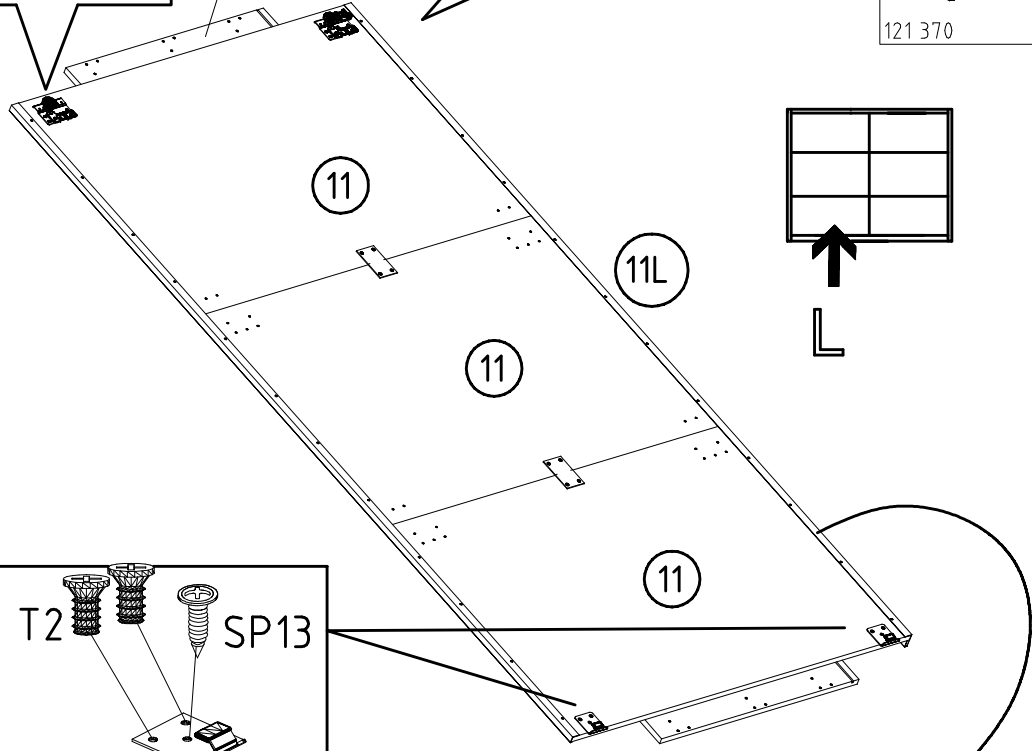
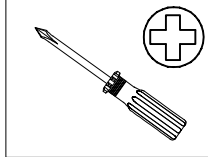
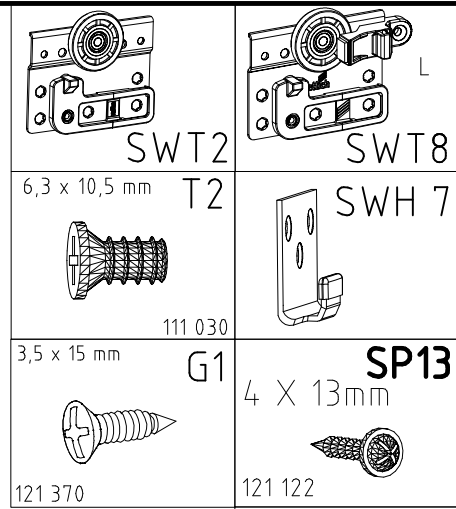
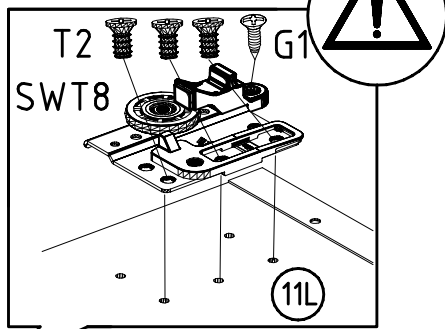
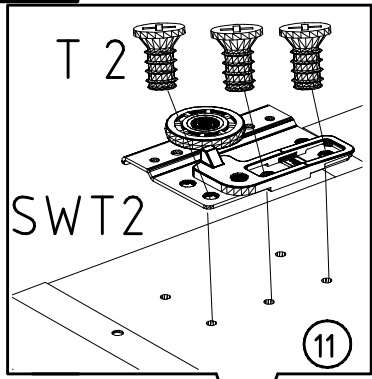

1

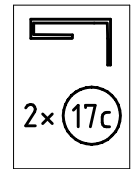
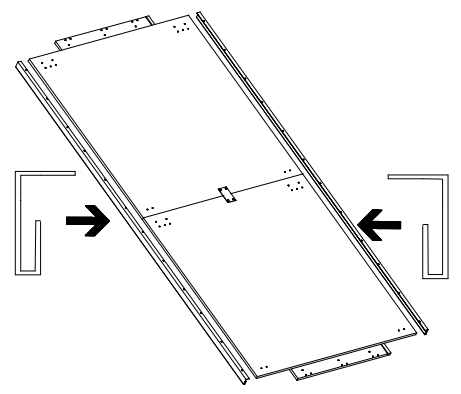
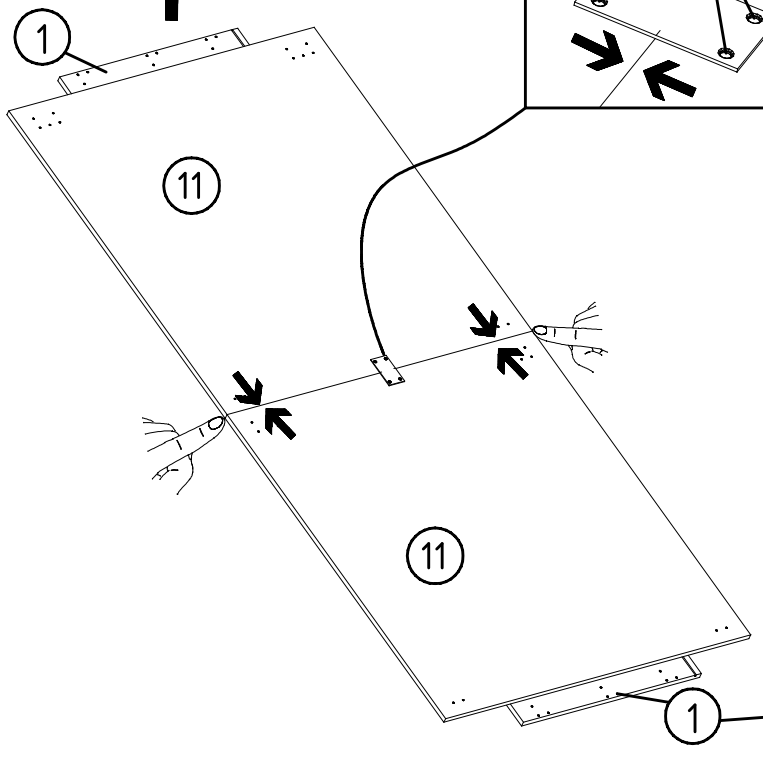
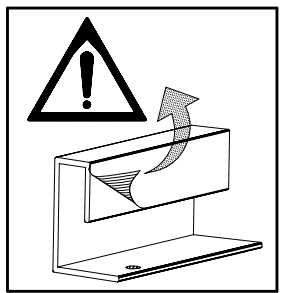
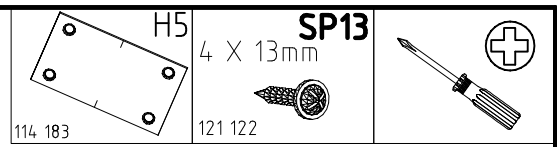
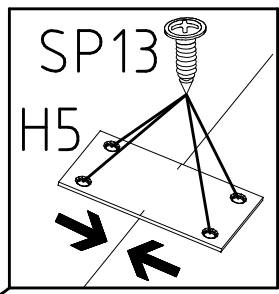
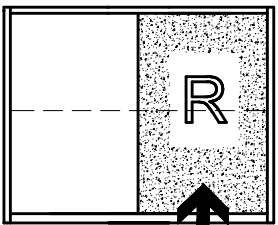

2

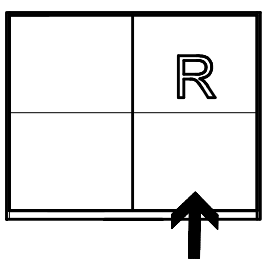
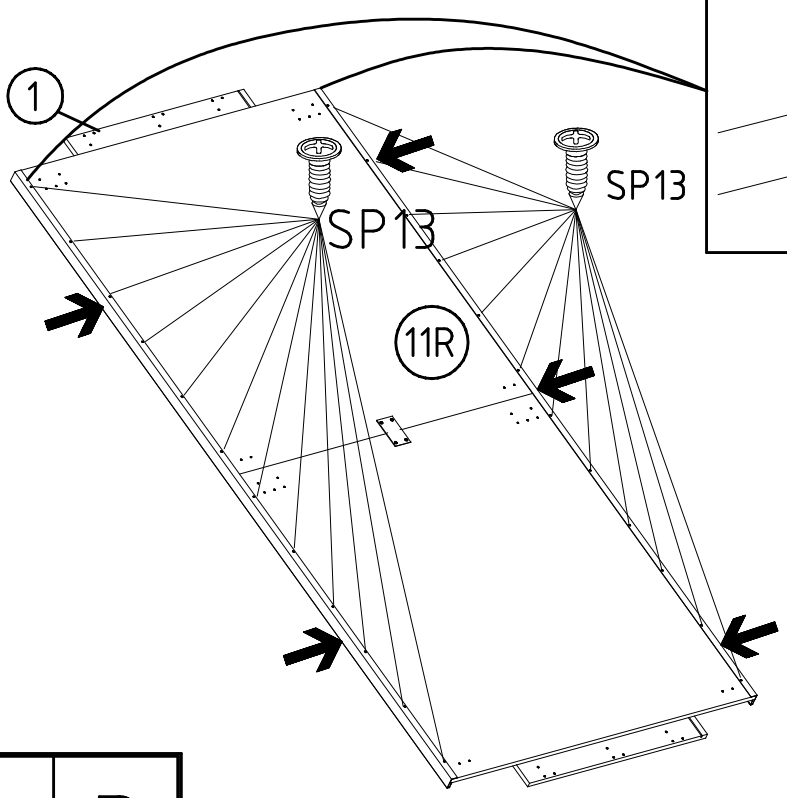
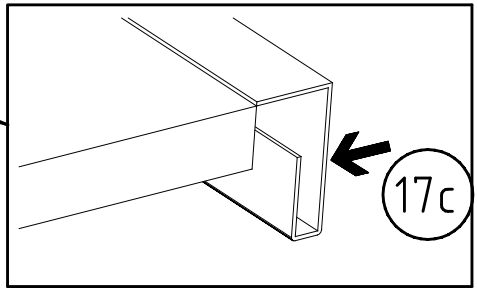
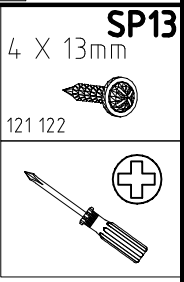

3

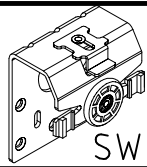

SWT 1

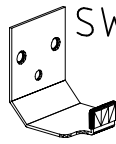

SWH 6

4 X 13mm

SP13

121 122



6,3 x 10,5 mm T2

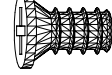

111 030

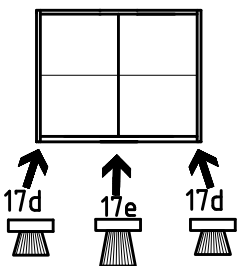
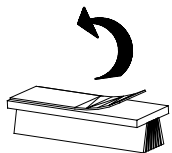
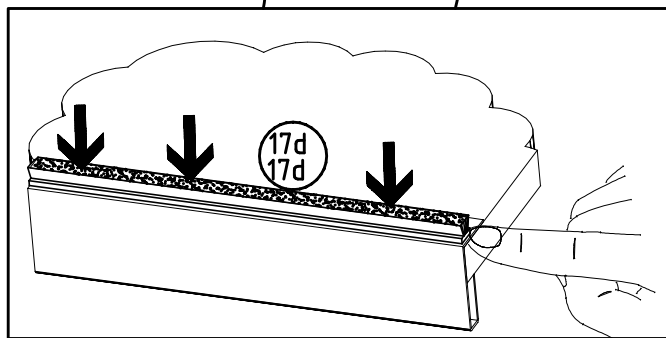
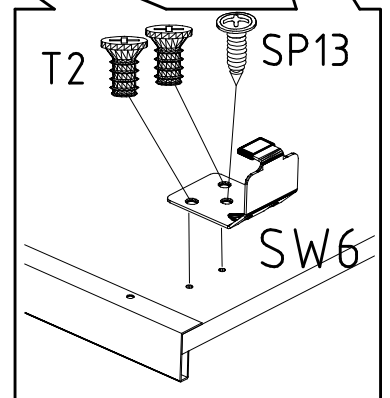
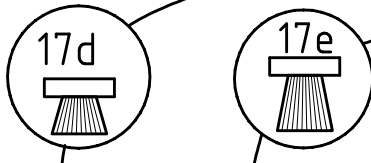
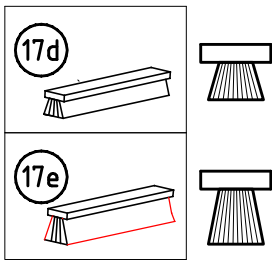
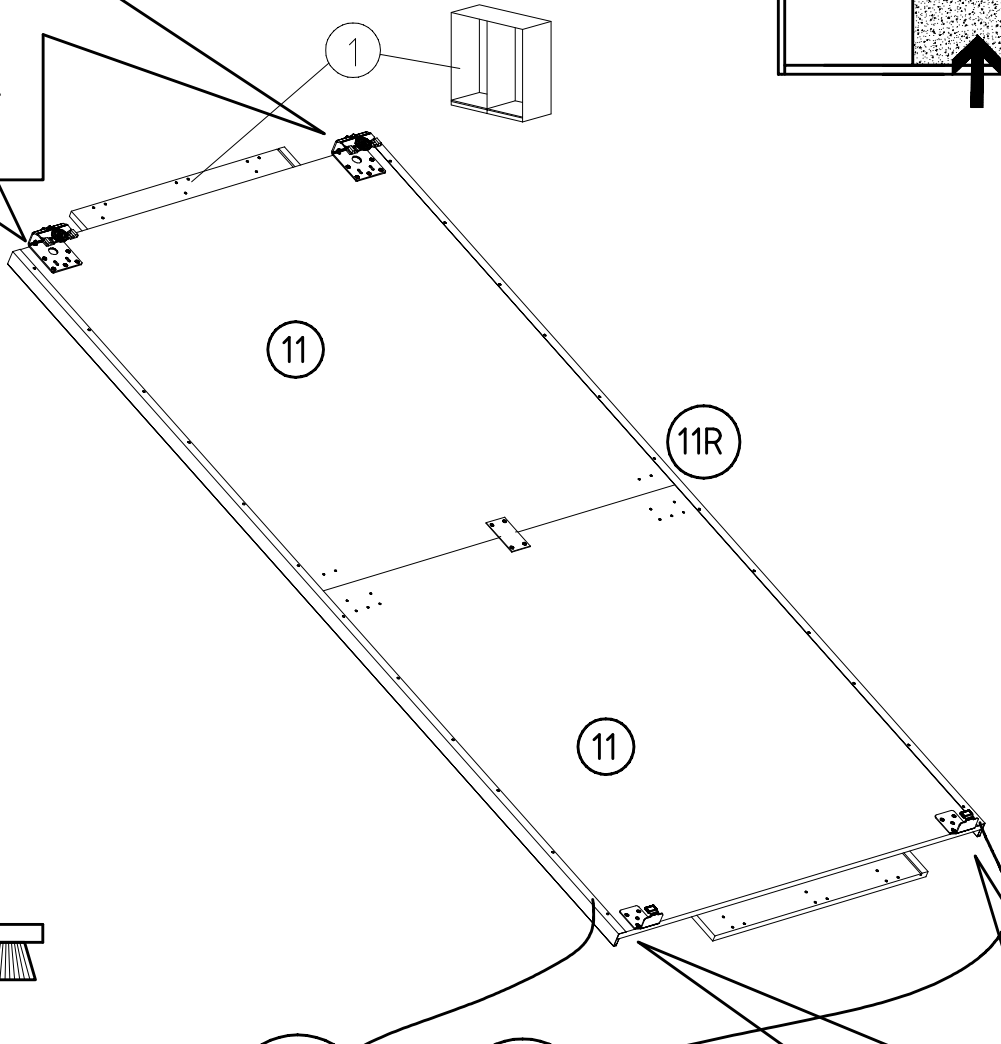
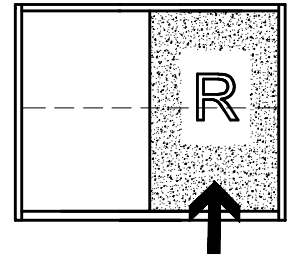
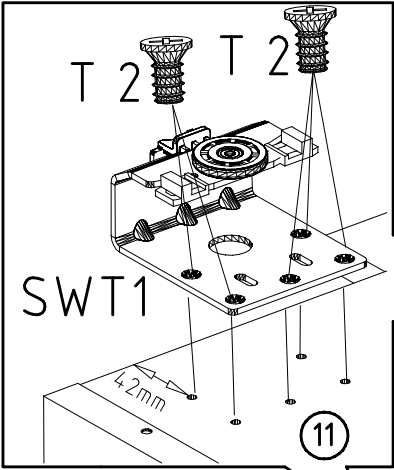
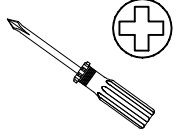

4

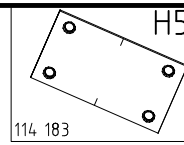
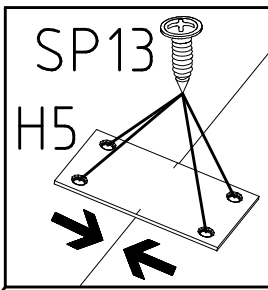
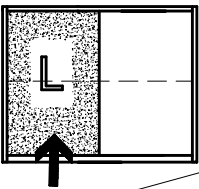

H5  
4 X 13mm  
SP13  
121 122

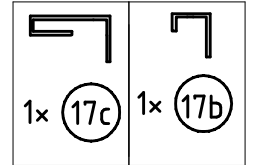
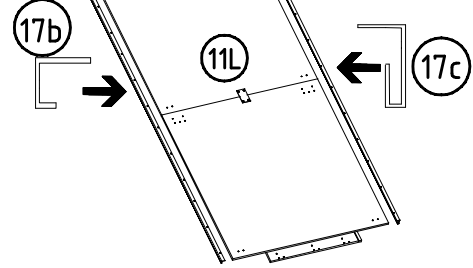
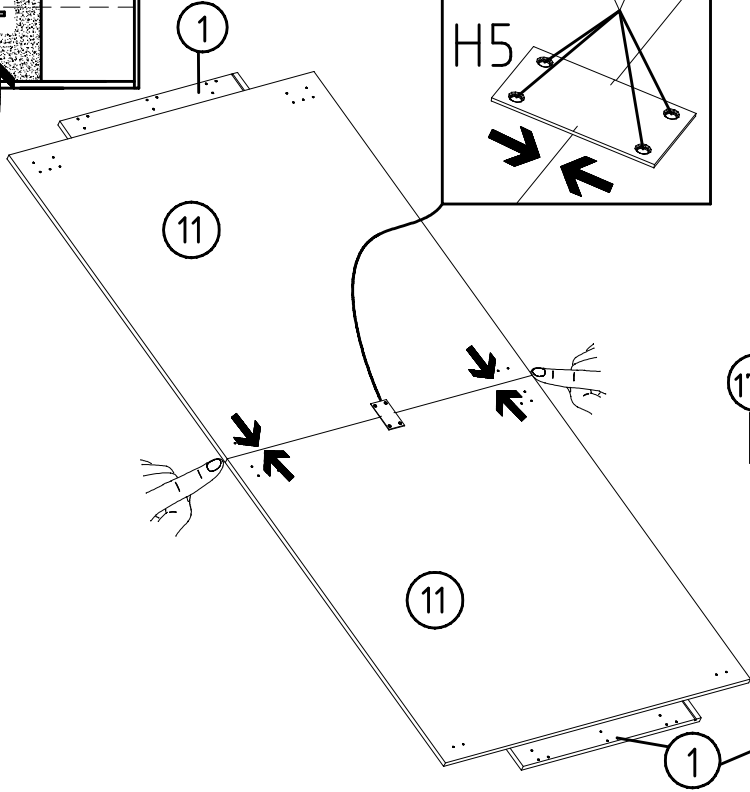
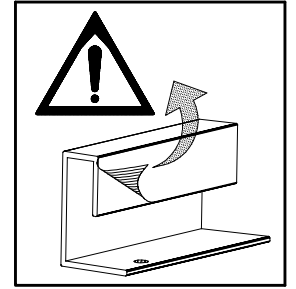
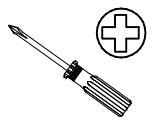

5

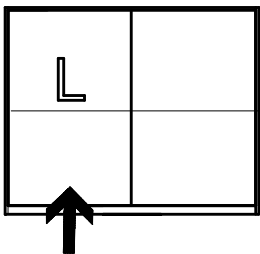
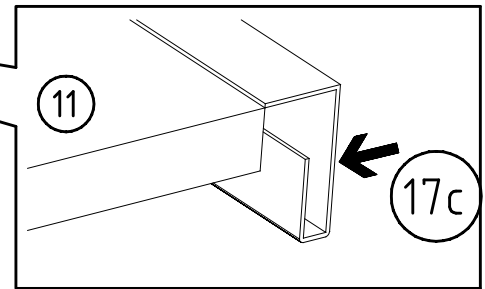
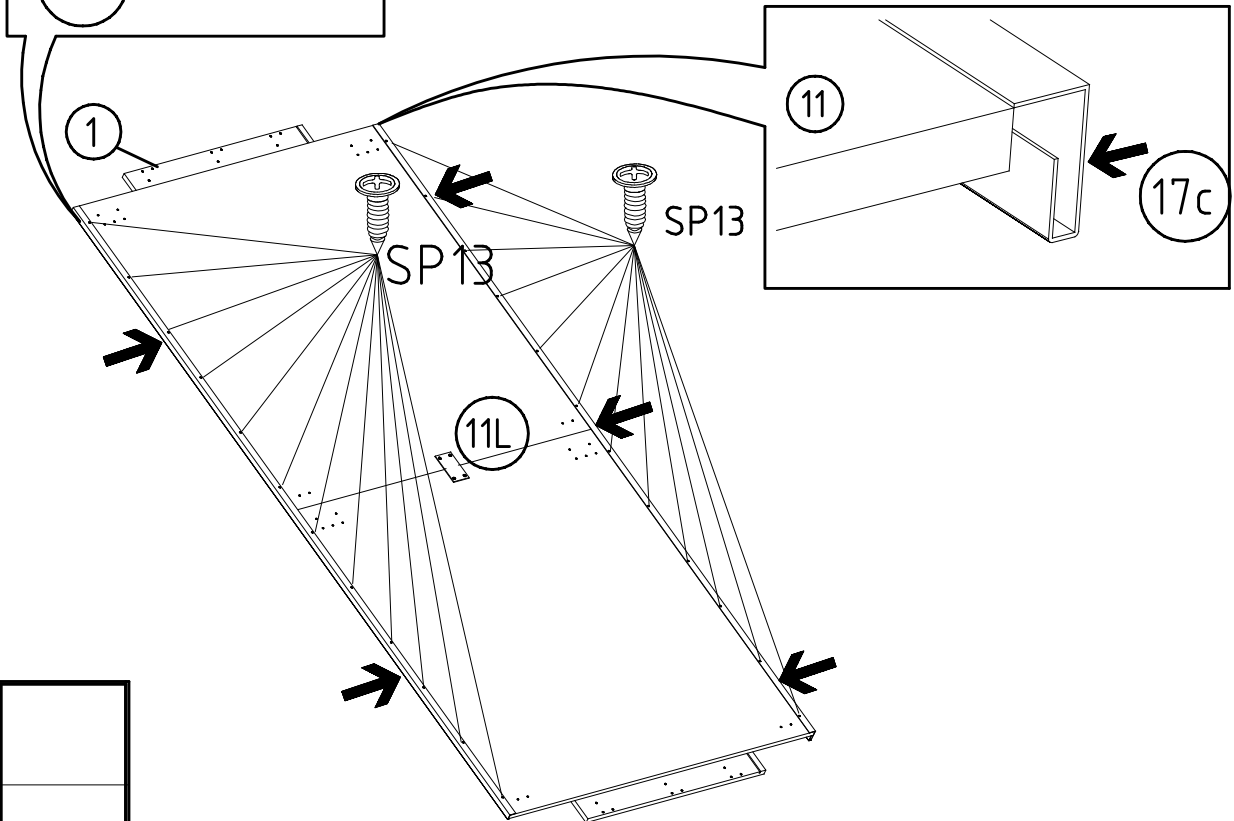
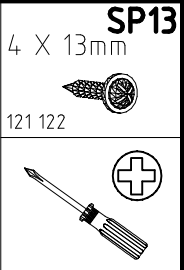
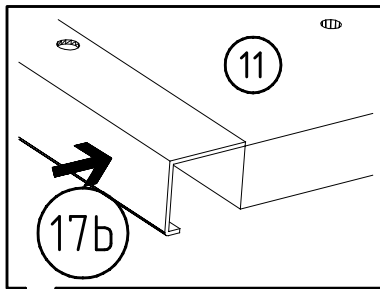

6

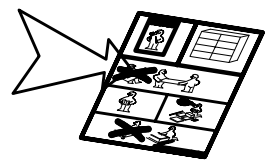
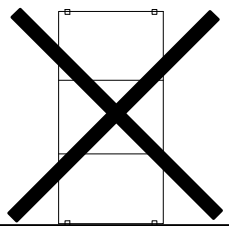
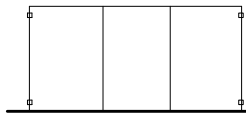
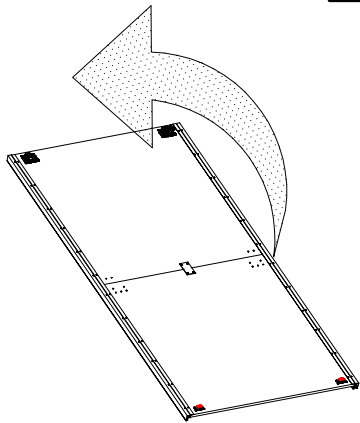
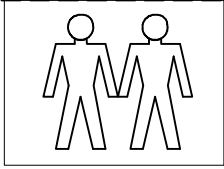
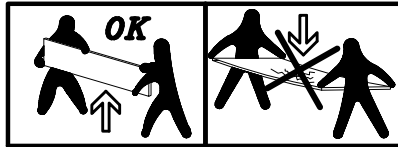
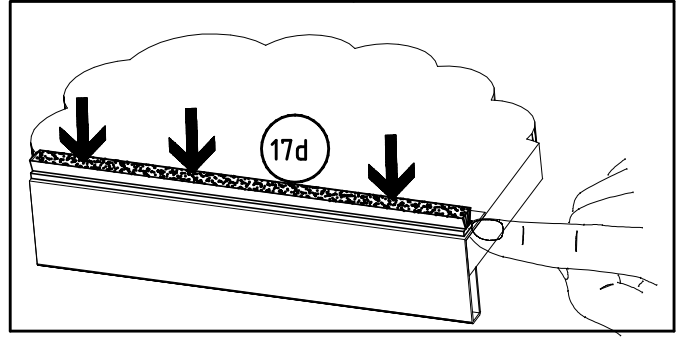
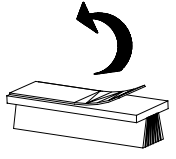
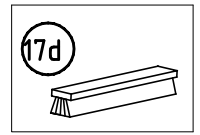
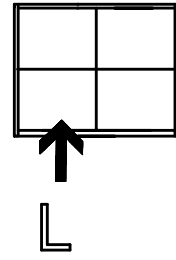
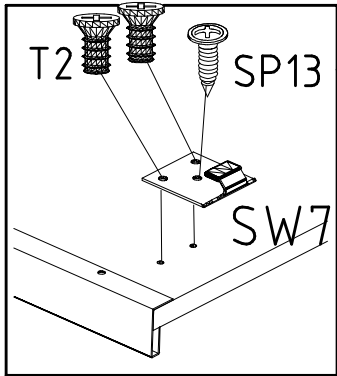
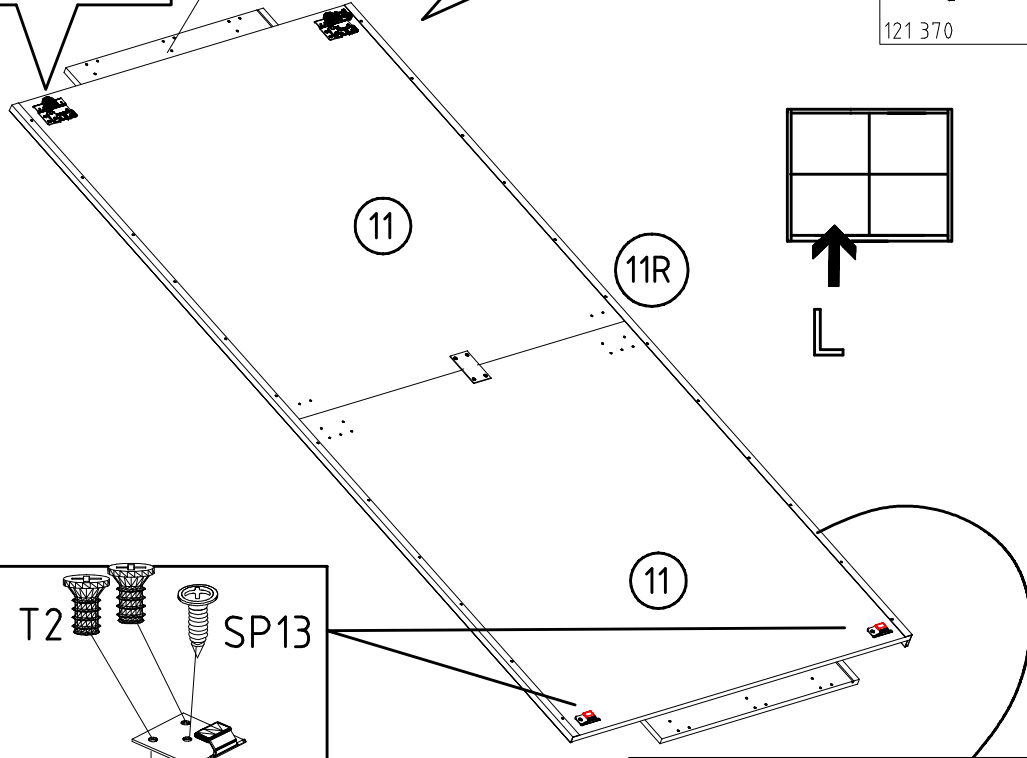
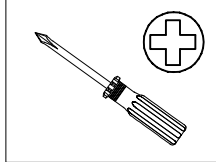
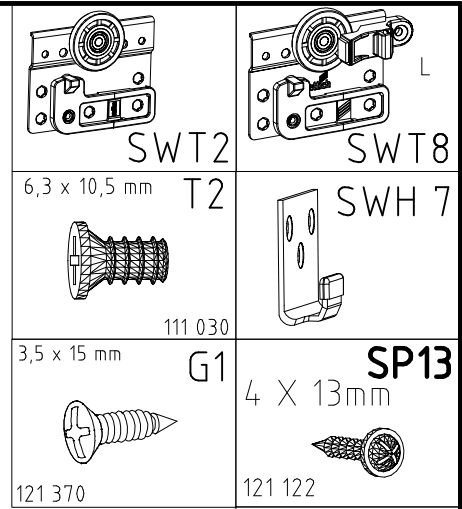
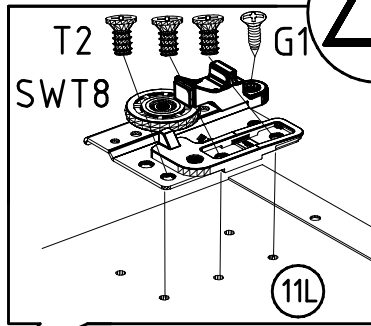
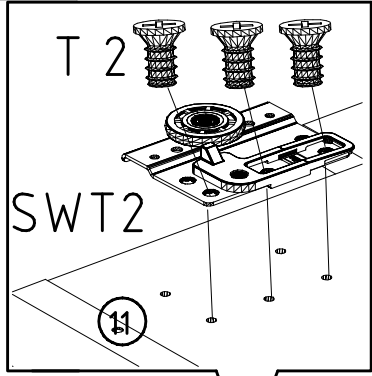

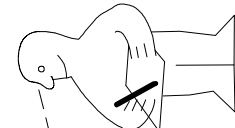
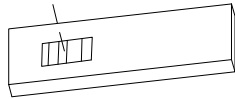
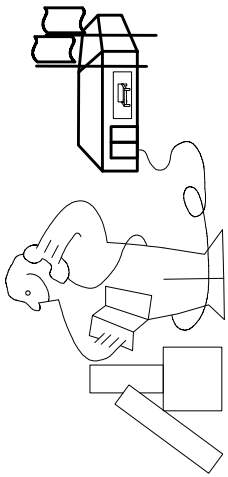
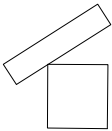
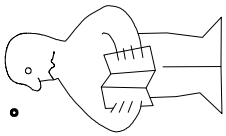

Modell/Model/Modèle

\_\_\_\_\_

\_\_\_\_\_

\_\_\_\_\_



\_\_\_\_\_

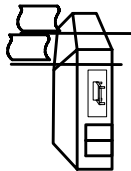

\_\_\_\_\_

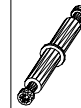
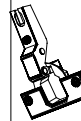
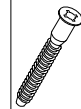

{121 370}

{ G 1 }

{4x}

980830

26.11.16 / -

11 16

11/11

Änderungen die dem technischen Fortschritt geschuldet sind, behalten wir uns vor !

Bei nicht vorschriftsmäßiger und/ oder nicht fachmännischer Montage wird bei Personen- und/ oder Sachschäden keinerlei Haftung übernommen.

WIMEX Wohnbedarf/ Import Export Handels GmbH/ Postfach 1407/ 49112 Georgsmarienhütte/ Germany  
Tel.:(+49) 054-01 8598 16/17 Fax.:(+49) 054-01 8598 33 Mail: service\_H@wimex-online.com

104P-NR. / 104P-NO.    150X-NR. / 150X-NO.    Auftrag/Order-No. / No. de Commande

**23203**    **30110XY**    104

Kunde    MAX MUSTERMANN  
Customer  
Client

Kommission / your order reference / votre reference

**3377 MINDEN**

---

Dekor / Decor    Decor / Modell / Modele

**F99**    **SAMPLE**

F99842    SCHWEBETUERENSCHRANK 250 CM H 216CM  
PLANKENEICHE NB + RAU STEEL  
PLANKENEICHE NACHBILDUNG

202320301107241476000001

Paket / Package / Paquet

**414760**

SOCKEL

Paket 1 von 8    Colli Kommission 10

HSP-SMT BOD 50 TEXT/TEX SOCKEL 32 FRESH    TV / LF 104  
SO-BOD TEXT RASTEX/ ZNBOD D18MM TX KLSTA

Montage - Anleitung    Laenge ..... 520,0    OBEREN  
KS-64    Breite ..... 568,0

**SOCKEL32 KLEB**

Bei Warenauslieferung für Rückgabe beachten.  
En cas de livraison de marchandises veuillez retourner le bordereau d'envoi.



OBEREN 5 30/19 HAUT 23.08.19 OBEREN 1 1. JABOVE OBEREN

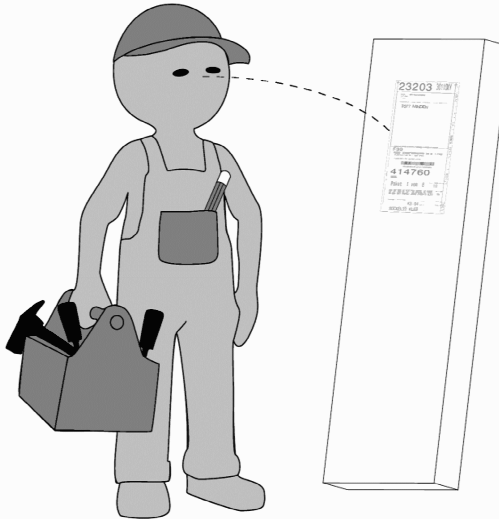

**WIMEX Wohnbedarf**  
Import Export Handelsges mbH & Co. KG  
Werner-von-Siemens-Str. 35  
D-49124 Georgsmarienhütte - Germany

**SAMPLE**    **23.08.19**  
Modellname    Produktionsdatum  
Model    Date of manufacture

