



IMPORT VERTRIEBSGESELLSCHAFT MBH

Käthe-Kruse-Str. 5
26160 Bad Zwischenahn
Germany

- | | | | |
|----|--------------------------|-----|------------------------|
| D | Montageanleitung | GB | Assembly Instructions |
| NL | Montagehandleiding | PL | Instrukcja montażu |
| TR | Montaj rehberi | RUS | Руководство по монтажу |
| E | Instrucciones de montaje | F | Notice de montage |
| I | Istruzioni di montaggio | CZ | Návod k montáži |
| SK | Návod na montáž | RO | Instrucțiuni de montaj |
| H | Szerelési útmutató | SLO | Montaža |

LOS ANGELES

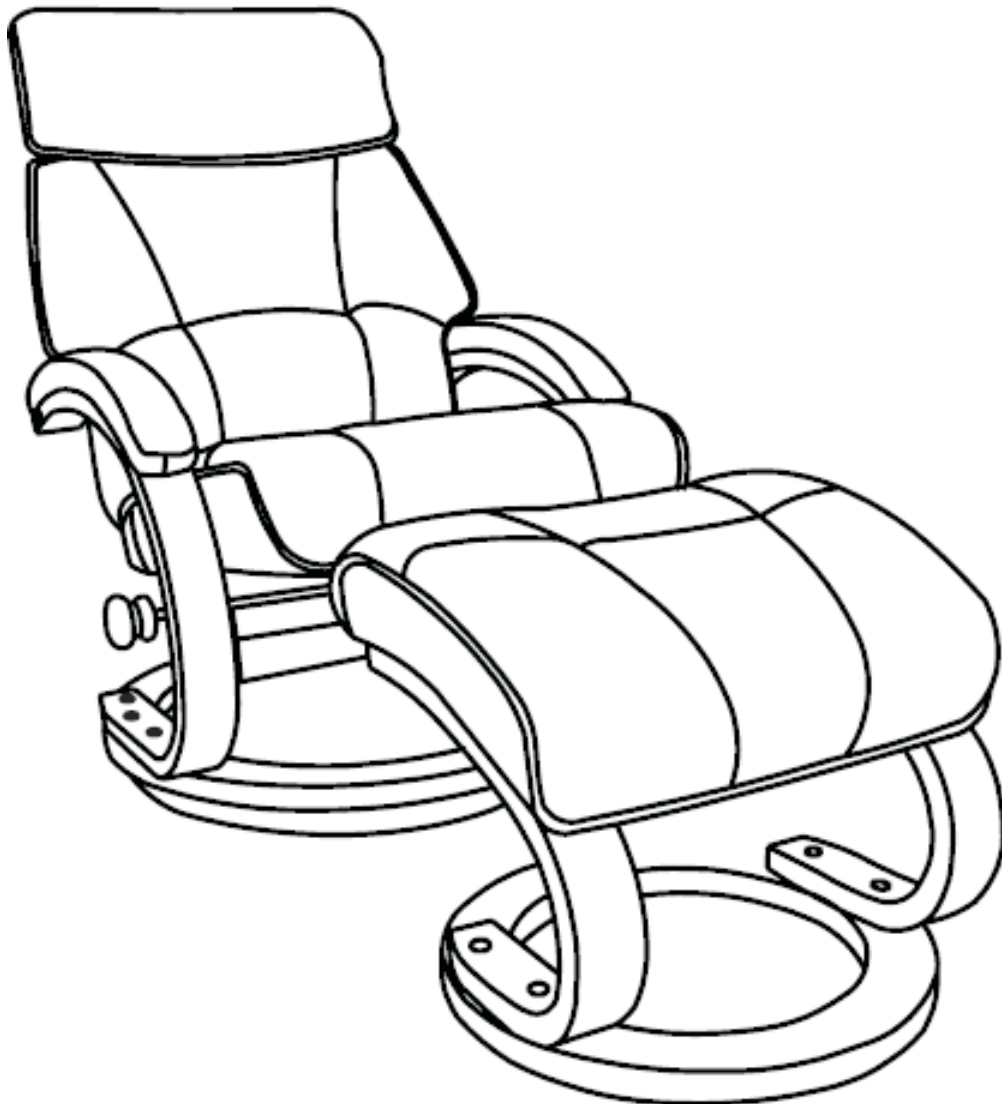



- | | | | |
|------|---------------------------------------------|-------|---------------------------------------------------|
| (D) | Sicherheits- und Gebrauchshinweise | (GB) | Safety instructions and usage information |
| (NL) | Veiligheids- en gebruiksrichtlijnen | (PL) | Wskazówki dotyczące bezpieczeństwa i eksploatacji |
| (TR) | Güvenlik ve Kullanım Talimatları | (RUS) | Инструкции по безопасности и использованию |
| (E) | Instrucciones de seguridad y uso | (F) | Consignes de sécurité et d'utilisation |
| (I) | Istruzioni di sicurezza e utilizzo | (CZ) | Bezpečnostní pokyny a pokyny k použití |
| (SK) | Bezpečnostné pokyny a pokyny pre používanie | (RO) | Instrucțiuni de siguranță și utilizare |
| (H) | Biztonsági és használati utasítások | (SLO) | Varnostna opozorila in navodila za uporabo |

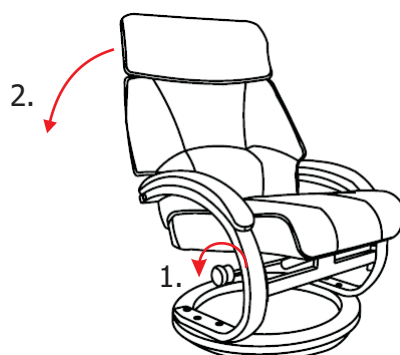



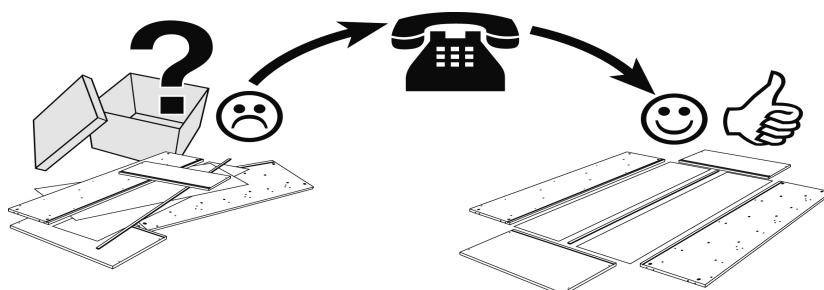
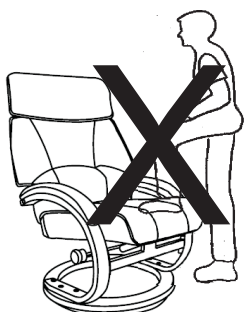

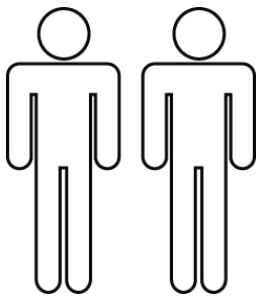

- | | | | |
|-------|-----------------------------------------|------|-----------------------------------|
| (D) | Nach 5 Wochen nachziehen | (F) | Resserrer après 5 semaines |
| (NL) | Na 5 weken aandraaien | (I) | Serrare dopo 5 settimane |
| (TR) | 5 hafta sonra tekrar sıkın | (CZ) | Po 5 týdnech dotáhněte |
| (GB) | Retighten after 5 weeks | (SK) | Po 5 týždňoch dotiahnuť |
| (PL) | Dokręćcić po 5 tygodniach | (RO) | Strângeți după 5 săptămâni |
| (RUS) | Через 5 недель подтянуть | (H) | 5 hét elteltével utána kell húzni |
| (SLO) | Vijake je treba po petih tednih priviti | (E) | Reapretar después de 5 semanas |

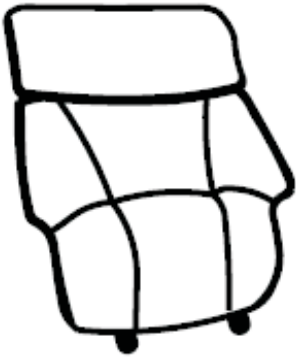



LOS ANGELES

<p>①</p> 	<p>②</p> 	<p>③</p> 	<p>④</p> 
<p>⑤</p> 	<p>⑥</p> 		

(7) 4x

(8) 4x

(9) 2x

(10) 2x

(11) 4x

(12) 2x

(13) 2x

(14) 2x

(15) 1x

(16) 1x



M6x40mm

M8x50mm

M8x75mm

M8x25mm

M8x22x2mm

M6

M8

