

MAXIME

3-sitzer

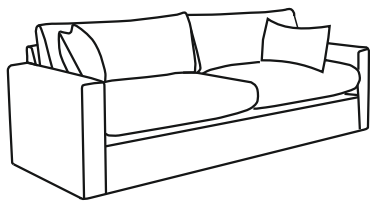

20 min

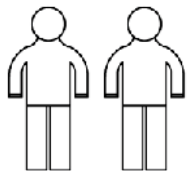

- | | |
|----------------------------------|------------------------------|
| (D) Montageanleitung | (GB) Assembly instructions |
| (FR) Notice de montage | (IT) Istruzioni di montaggio |
| (NL) Handleiding voor de montage | (PL) Instrukcja montażu |
| (CZ) Montážní návod | (SK) Návod na montáž |
| (HU) Szerelési útmutató | (RO) Instrucțiuni de montaj |
| (TR) Montaj talimatı | (RU) Инструкция по монтажу |

1

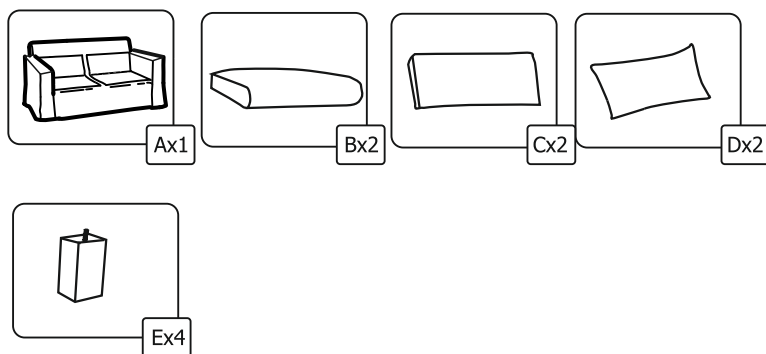
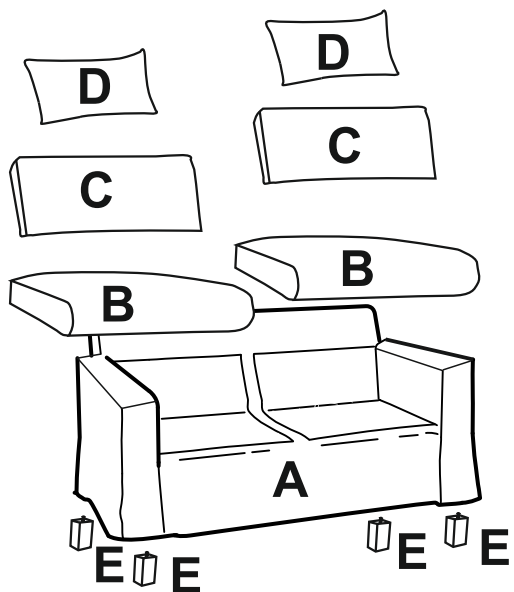

2

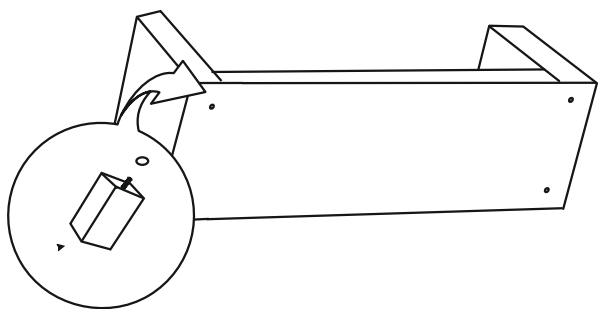

3

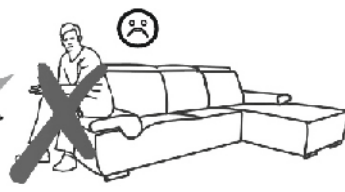
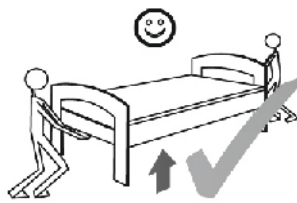
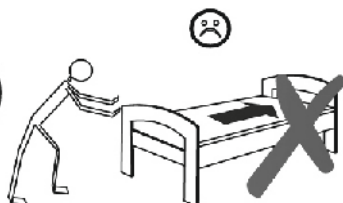

**Service • Assistenza • Dienstverlening • Serwis
Servis • Szerviz • Сервисная служба**

Name • Nom • Nome • Naam •
Nazwa • Jméno • Názov • Név •
Denumire • Isim • Название **MAXIME**

Nr • No. • N° • Номер • Č • Sz **3-sitzer**

Typ • Type • Tip • Típus • Tipo •
Тип

