

Art. Nr. 2839950

1/6



06.10.2017

Art.Nr. 2839950



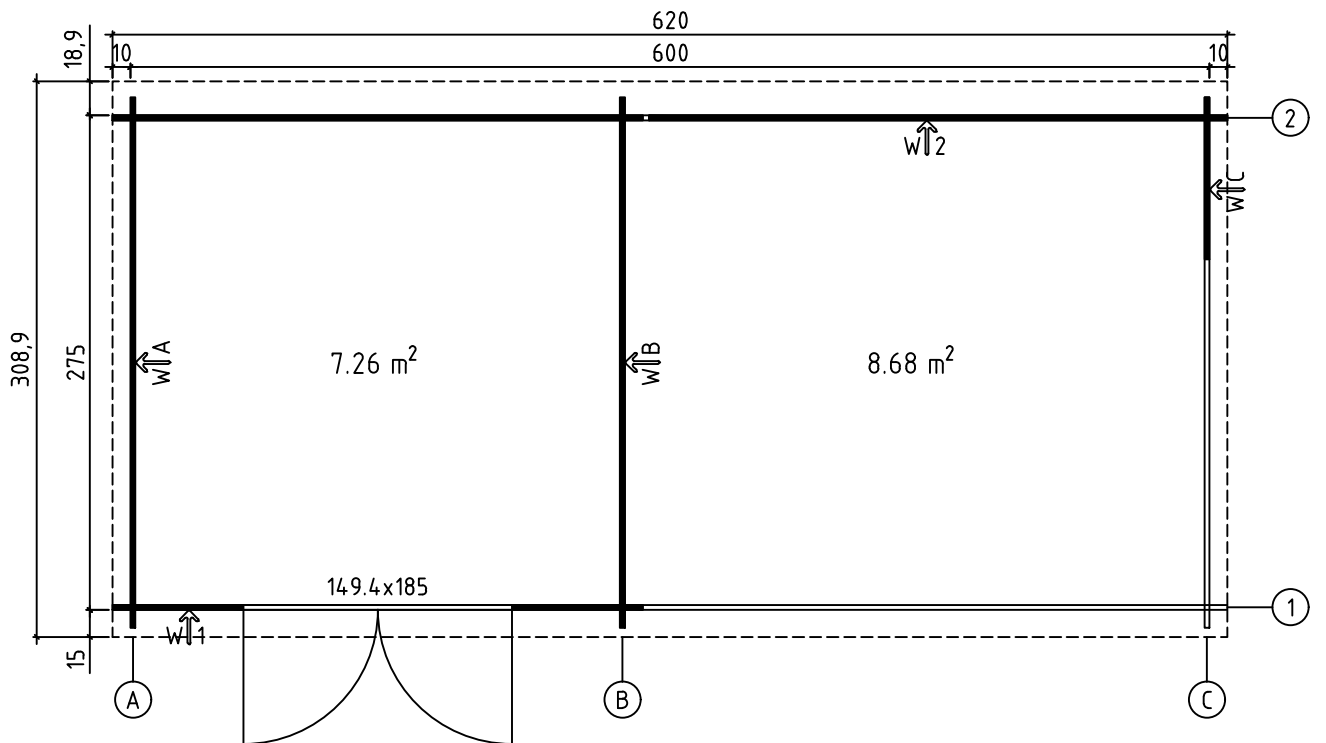

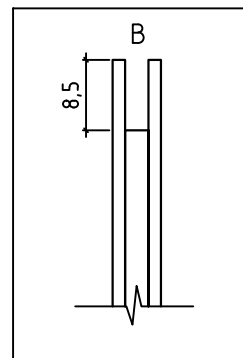
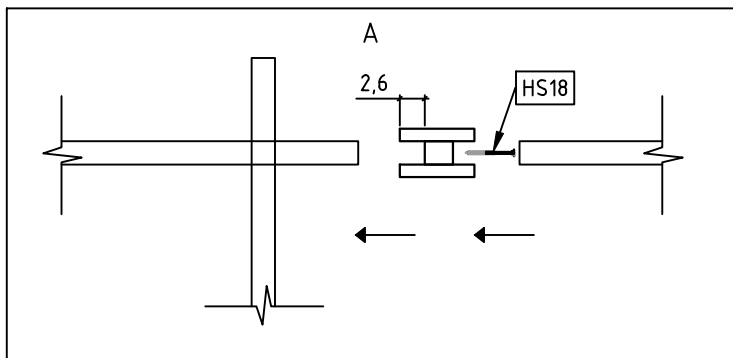
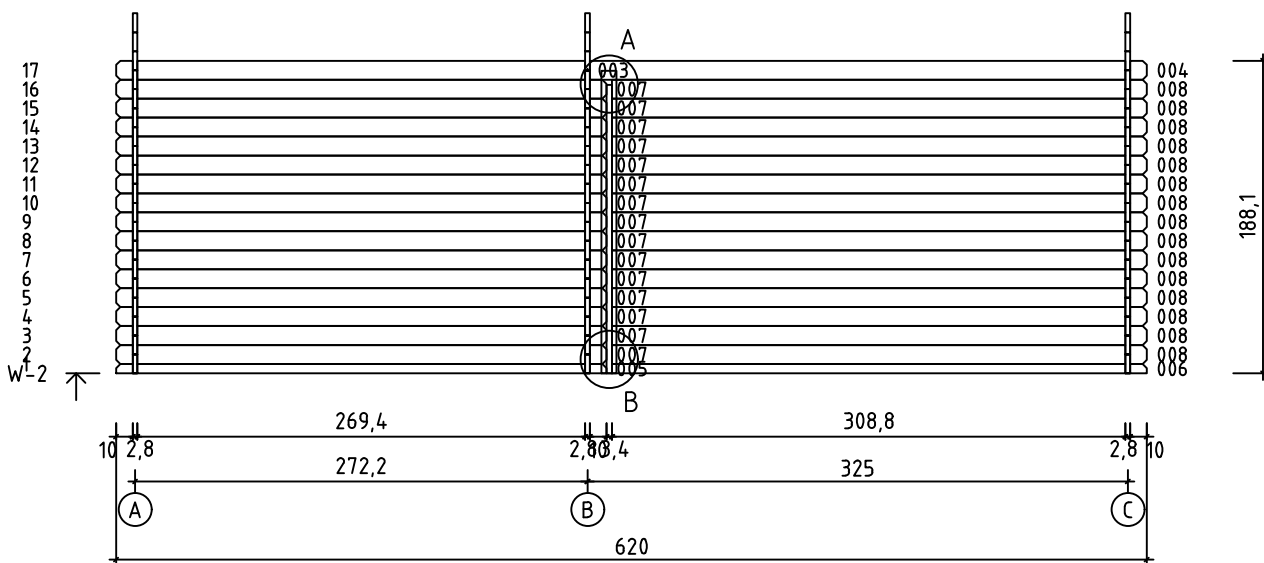
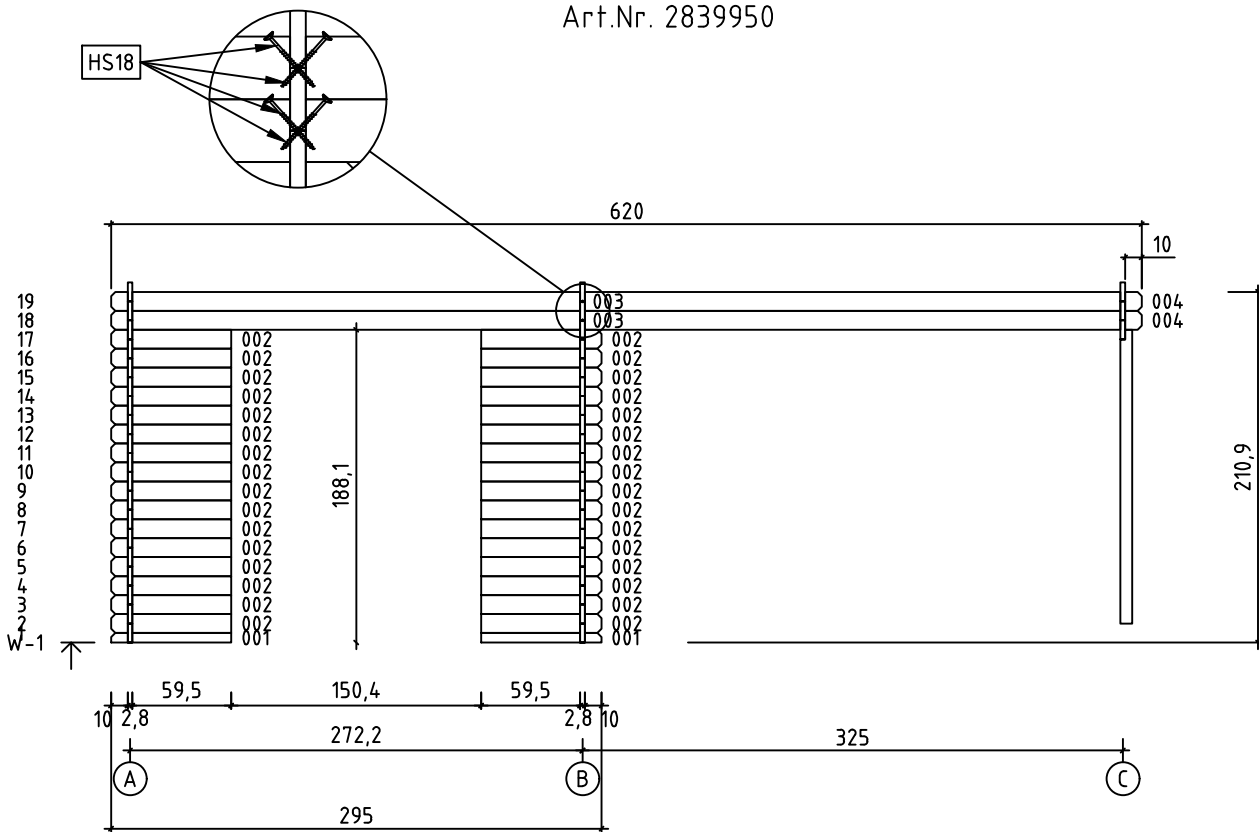

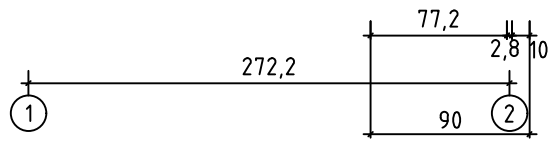
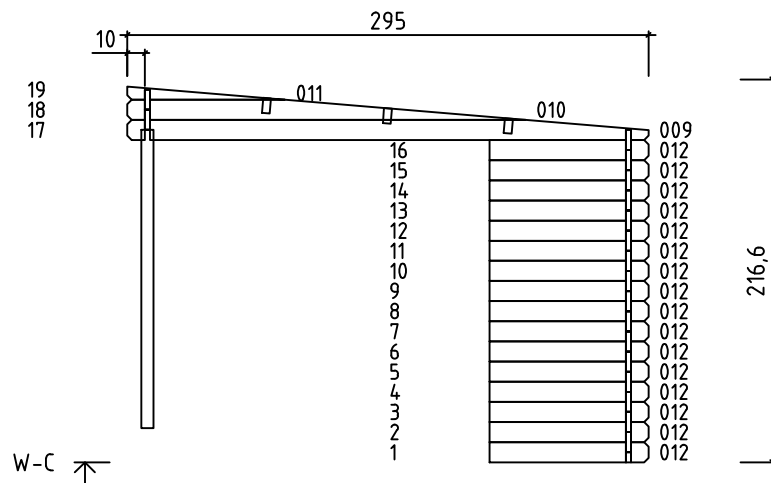
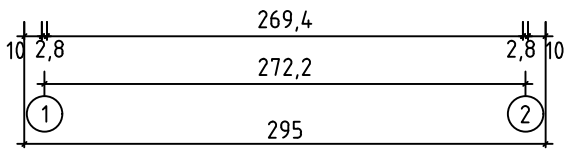
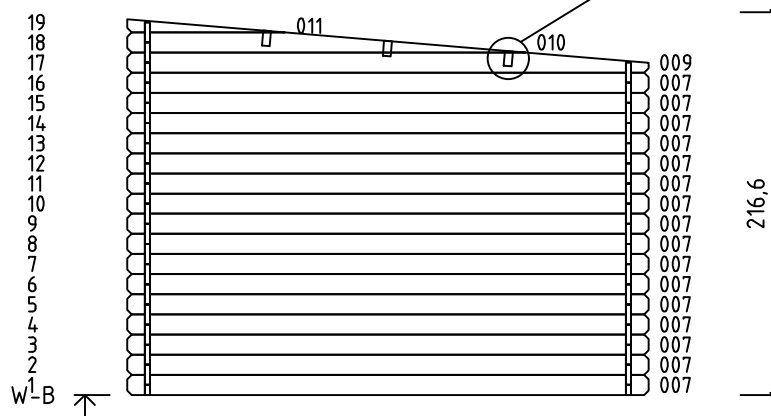
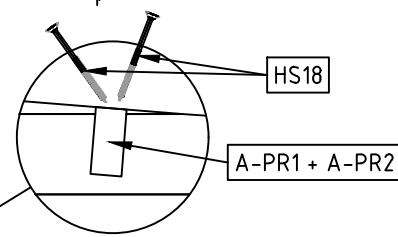
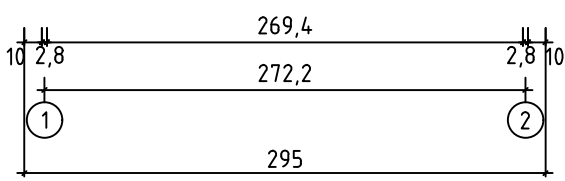
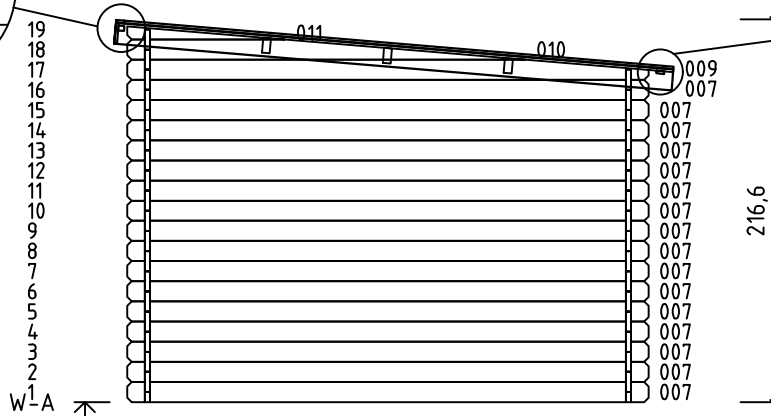
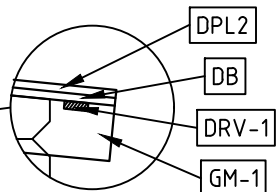
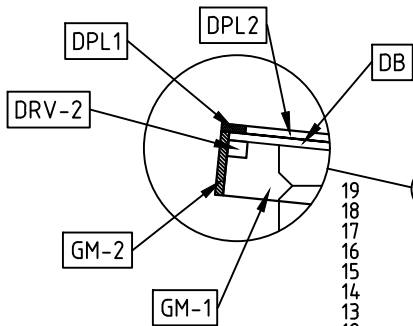

Grundplan - Grundplan - Plan de masse - Planimetria - Plattegrond - Põhiplaan

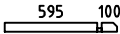
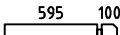
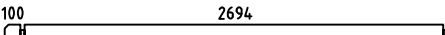
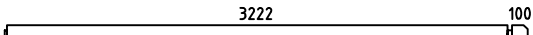
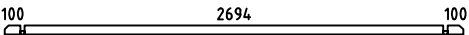
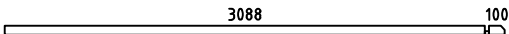
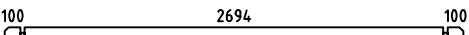
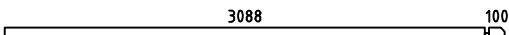
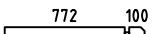
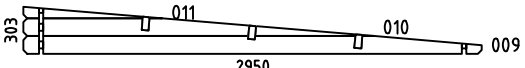
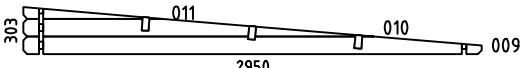
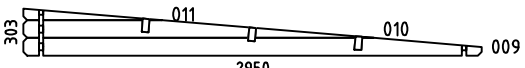
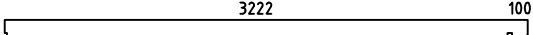
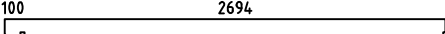
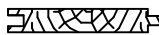



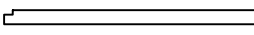



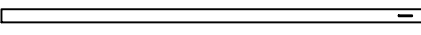

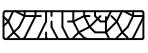
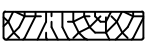





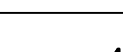





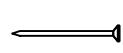
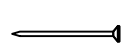

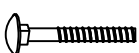

Art.Nr. 2839950

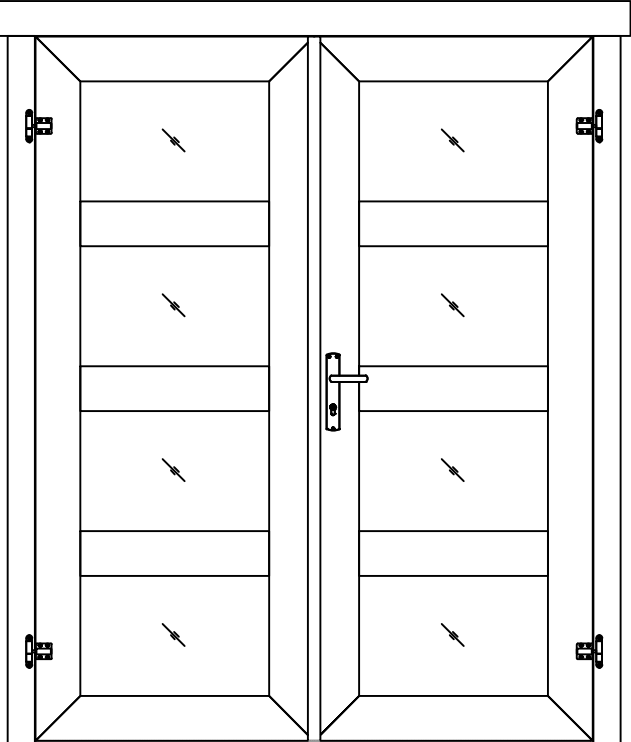
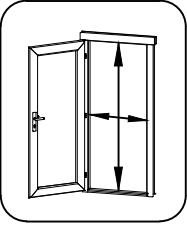

| Pos   | 06.10.2017 Piece list - Stückliste - Liste des pièces - Elementi - Stuklijst - Tükítabel<br>Art.Nr. 2839950  | 5/6 | Q  | P<br>(mm) | L<br>(mm) |
|-------|--|-----|----|-----------|-----------|
| 001   |   |     | 2  | 28x57     | 723       |
| 002   |   |     | 32 | 28x114    | 723       |
| 003   |   |     | 3  | 28x114    | 2836      |
| 004   |   |     | 3  | 28x114    | 3364      |
| 005   |   |     | 1  | 28x57     | 2950      |
| 006   |   |     | 1  | 28x57     | 3216      |
| 007   |   |     | 47 | 28x114    | 2950      |
| 008   |   |     | 15 | 28x114    | 3216      |
| 012   |   |     | 16 | 28x114    | 900       |
| WA-1  |   |     | 1  |           |           |
| WB-1  |    |     | 1  |           |           |
| WC-1  |    |     | 1  |           |           |
| A-PR2 | Roof beam - Dachbalken - Panne de toit - Perlina del tetto - Gordingen / dakbalk - Pärlin<br>   |     | 3  | 44x140    | 3364      |
| A-PR1 | Roof beam - Dachbalken - Panne de toit - Perlina del tetto - Gordingen / dakbalk - Pärlin<br>   |     | 3  | 44x140    | 2836      |
| DB    | Roof boards - Dachbretter - Voliges - Perlina per tetto - Dakhout - Katuselaud    |     | 69 | 90x15     | 3100      |
| DPL1  | Roofing felt fillet - Dachpappenleiste - Baguette de fixation du feutre bitumeux - Asse per fissaggio guaina bituminosa - Afdekljst asfaltpapier - Katusepapiilist  |     | 2  | 15x45     | 3115      |
| DPL2  | Roofing felt fillet - Dachpappenleiste - Baguette de fixation du feutre bitumeux - Asse per fissaggio guaina bituminosa - Afdekljst asfaltpapier - Katusepapiilist  |     | 2  | 15x45     | 3120      |
| DPP-1 | Roofing felt (strip) - Dachpappe (bahnen) - Feutre bitumeux (bande) - Cartone catramato - Asfaltpapier (baan) - Katusepapp    |     | 4  |           | 6300      |
|       | Post - Pfosten - Poteau - Piede registrabile - Stijl - Post   |     | 1  | 90x90     | 1730      |
|       | H-profile - H-profilis - Profile h - Profilo ad h - H-profiel - H-profiil   |     | 1  | 90x58     | 1820      |
| DRV-1 | Roof edge reinforcement - Dachrandverstärkung - Corniere de renfort de bord de toit - Rinforzo x tetto - Dakrand versterking - Räästatugevdus                       |     | 2  | 15x45     | 3100      |
| DRV-2 | Roof edge reinforcement - Dachrandverstärkung - Corniere de renfort de bord de toit - Rinforzo x tetto - Dakrand versterking - Räästatugevdus                       |     | 2  | 28x34     | 3100      |
| KFS-1 | Storm protection - Sturmleiste - Latte anti-tempete - Protezione anti vento - Stormverankering / beveiliging - Tormikinnitusliist                                    |     | 5  | 22x45     | 2050      |

| Pos  | 06.10.2017 Piece list - Stückliste - Liste des pièces - Elementi - Stuklijst - Tükítabel<br>Art.Nr. 2839950 6/6   | Q   | P<br>(mm) | L<br>(mm) |
|------|---|-----|-----------|-----------|
|      | U-profile - U-profils - Profile u - Profilo ad u - U-profiel - U-profiil   | 1   | 28x58     | 1780      |
|      | Gable moulding - Giebelleiste - Planche de rive - Finitura per frontale e retro del tetto - Gevellijst - Viilulaud   | 2   | 15x120    | 3100      |
|      | Gable moulding - Giebelleiste - Planche de rive - Finitura per frontale e retro del tetto - Gevellijst - Viilulaud   | 2   | 15x120    | 3165      |
| HS9  | Screw for u-profile - Schraube zur befestigung u-profils - Vis a tete fraisée pour profil u - Vite per profilo ad u - Schroef ter bevestiging u-profiel - Kruvi U-profiilile   | 5   | 3.5x50    |           |
| HS9  | Screw for gable moulding - Schrauben für giebelleiste - Vis pour fixation planche de rive - Vite per fissare finiture davanti e dietro del tetto - Schroef voor gevellijst - Kruvi viilulauale   | 20  | 3.5x50    |           |
| HS4  | Screw for roof edge reinforcement - Schrauben für dachrandverstärkung - Vis pour fixation corniere renfort de bord de toit - Viti x rinforzo bordo tetto - Schroef voor dakrand versterking - Kruvi räästatugevdusele    | 14  | 3x30      |           |
| HS14 | Screw for post - Schrauben für pfosten - Vis de fixation des poteaux - Viti per inviare - Schroef voor stijlen - Kruvi postile   | 2   | 4.5x80    |           |
| HS12 | Screw for roof edge reinforcement - Schrauben für dachrandverstärkung - Vis pour fixation corniere renfort de bord de toit - Viti x rinforzo bordo tetto - Schroef voor dakrand versterking - Kruvi räästatugevdusele    | 14  | 4x40      |           |
| HS12 | Screw for gable moulding - Schrauben für giebelleiste - Vis pour fixation planche de rive - Vite per fissare finiture davanti e dietro del tetto - Schroef voor gevellijst - Kruvi viilulauale   | 14  | 4x40      |           |
| HS13 | Screw for h-profile - Schraube zur befestigung h-profils - Vis a tete fraisée pour profil h - Vite per profilo ad h - Schroef ter bevestiging h-profiel - Kruvi H-profiilile    | 1   | 4x60      |           |
| HS18 | Screw for roof beams - Schrauben für dachbalken - Vis pour fixation pannes de toit - Viti per perline del tetto - Schroef voor gordingen / dakbalken - Kruvi pärlinitele   | 12  | 5x120     |           |
| HS18 | Screw for wall details - Schraube für wand details - Vis pour mur details - Viti per elementi della porta - Schroef voor wand details - Kruvi seinadetailidele   | 6   | 5x120     |           |
| HS18 | Screw for gable - Schrauben für giebel - Vis pour fixation des pignons - Viti per timpano - Schroef voor gevelpunt - Kruvi viilude kinnitamiseks   | 12  | 5x120     |           |
| HS20 | Screw for post height adjustment - Schrauben für regulierungsschraube für pfosten - Vis de fixation de support réglable de poteau - Viti per fissare ed aggiustare l'altezza del palo verticale - Schroef voor hoogte instelling stijlen - Kruvi vajumispoldile  | 8   | 6x50      |           |
| SH28 | Hammer block - Schlagholz - Calle de frappe - Blocco di legno da usare come cuscinetto quando si usa il martello - Slagklos - Löögiklots   | 1   |           |           |
| SFS  | Nut for storm protection - Schraubenmutter für sturmleiste - Ecrou pour latte anti-tempete - Dado x asta protezione vento - Moer voor stromverankering - Mutter tormikinnitusliistule    | 10  | D6        |           |
| NF4  | Zn nail for roof - Zn nägel für dachbretter - Pointe pour fixation voliges de toit - Chiodi x perline tetto - Spijker(nagel) voor dakhout - Nael katuselauale    | 362 | 2x50      |           |
| NF5  | Zn nail for roofing felt fillet - Zn nägel für dachpappenleiste - Pointe pour baguette de fixation feutre bitumeux - Chiodi x carta bituminosa x tetto - Spijker(nagel) voor asfaltpapier afdekljst - Papiliistunael   | 28  | 2x40      |           |
| NF6  | Roofing nails for roofing felt - Nägel für dachpappe - Pointe pour fixation feutre bitumeux - Chiodi per cartone catramato - Asfaltnagel - Papinael    | 215 | 2.8x15    |           |
| BFS  | Bolt for storm protection - Bolzen für sturmleiste - Boulon pour latte anti-tempete - Bullone x asta protezione vento - Bout voor stormankerlat - Puidupolt tormikinnitusliistule    | 10  | 6x60      |           |
| DFS  | Washer for storm protection - Dichtscheibe für sturmleiste - Rondelle pour latte anti-tempete - Rondella x asta protezione vento - Afdichtring voor storm strip - Seib tormikinnitusliistule   | 10  | D6        |           |
|      | Post height adjustment - Regulierungsschraube für pfosten - Support réglable de poteau - Piede registrabile in altezza - Stelschroef voor stijlpost - Vajumispolt    | 1   | D20       |           |
|      | Door - Tür - Porte - Deur - Uks 1494x1850 TUK.4.020.SVP.MMX28 SGA+28  | 1   |           |           |

| Pos   | 18.12.2017 Piece list - Stückliste - Liste des pièces - Elementi - Stuklijst - Tükítabel<br>1494x1850 TUK.4.020.SVP.MMX28 SGA+28          | 1/2   | Q | P<br>(mm) | L<br>(mm) |
|---|---|---|---|-----------|-----------|
| <p>Glass size - Glasgröße - Taille de la vitre - Misura del vetro - Glas afmeting - Klaasi mõõt: 502x325 mm</p>   <p>1418x1792 mm</p> |   |   |   |           |           |
| 1   | Upper door jamb - Türrahmen oben - Cadre de porte supérieur - Telaio superiore della porta - Bovendorpel - Ukse ülemine leng              |  | 1 | 66x100    | 1438      |
| 2   | Left door jamb - Türrahmen links - Cadre de porte gauche - Telaio montante sinistro della porta - Linkerstijl deurframe - Ukse vasak leng |  | 1 | 66x80     | 1850      |
| 3   | Right door jamb - Türrahmen rechts - Cadre de porte droit - Telaio montante destro della porta - Rechterstijl deurframe - Ukse parem leng |  | 1 | 66x80     | 1850      |
| 4   | Doorstep - Swelle - Barre de seuil - Soglia della porta - Deurdorpel - Lävepak  |  | 1 | 20x21     | 1418      |
| 5   | Connection strip - Deckleiste - Baguette de battement - Profilo verticale della porta - Stulplijst - kokkuvaltšiliist                     |  | 1 | 13x32     | 1812      |





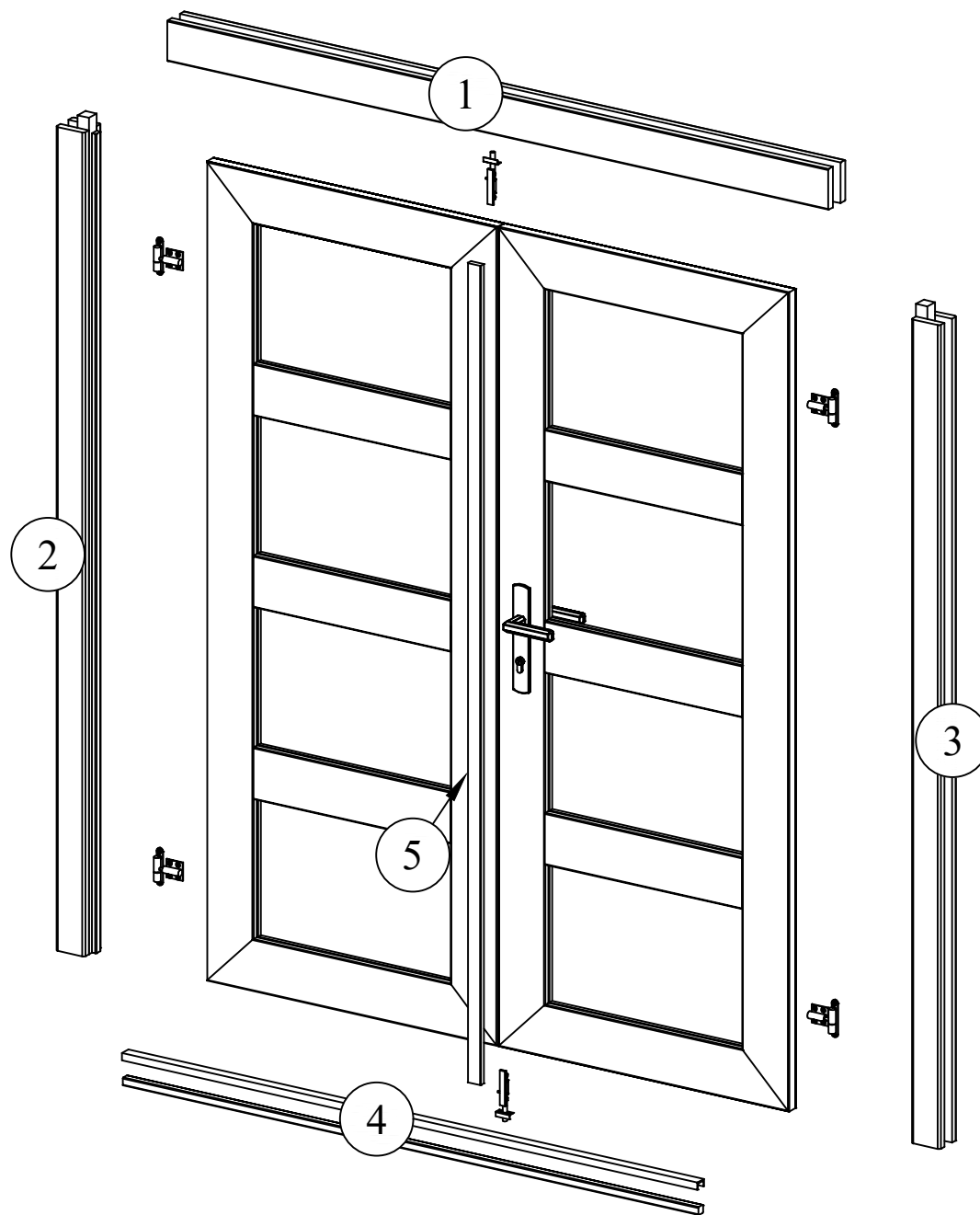

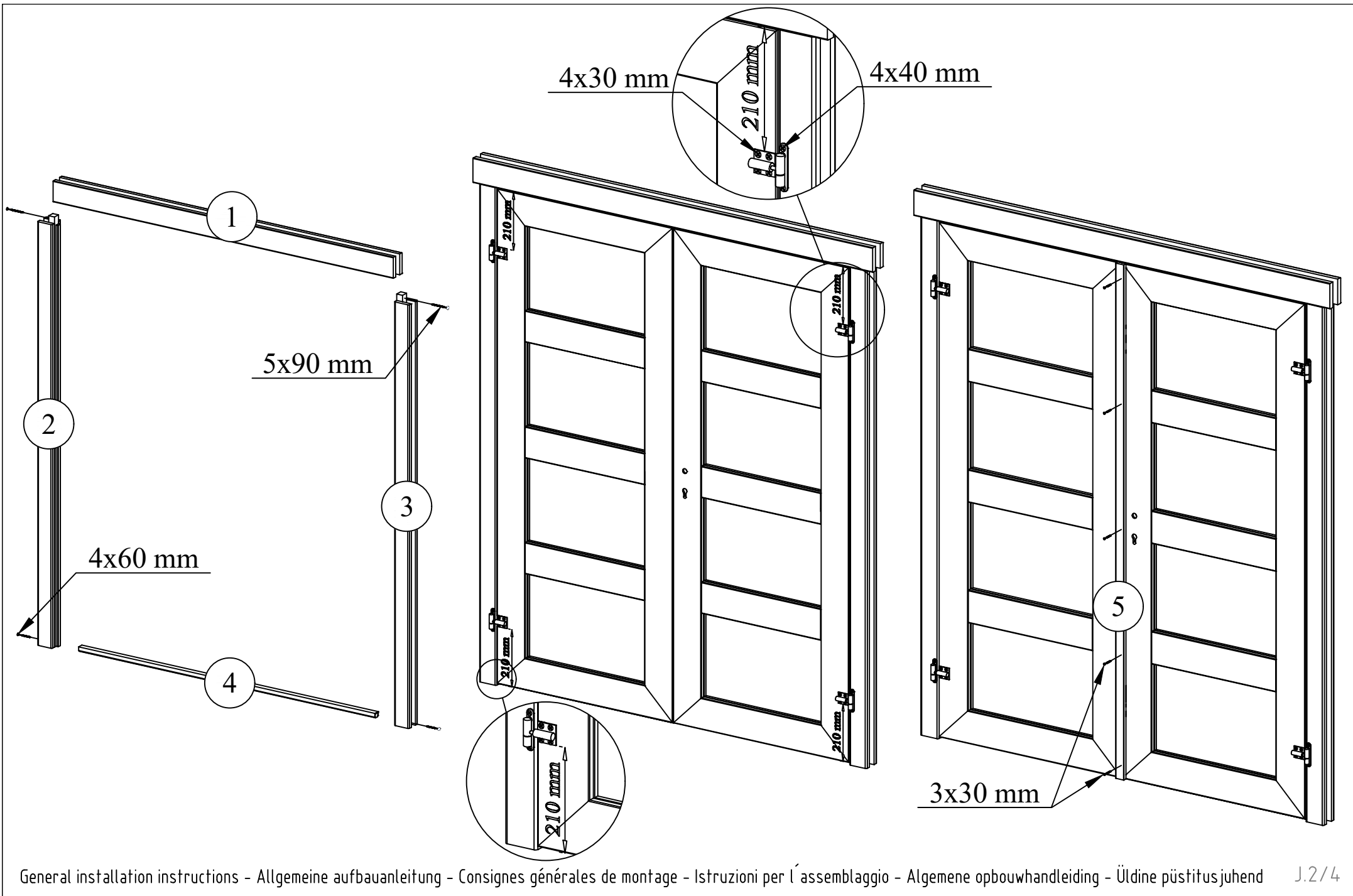

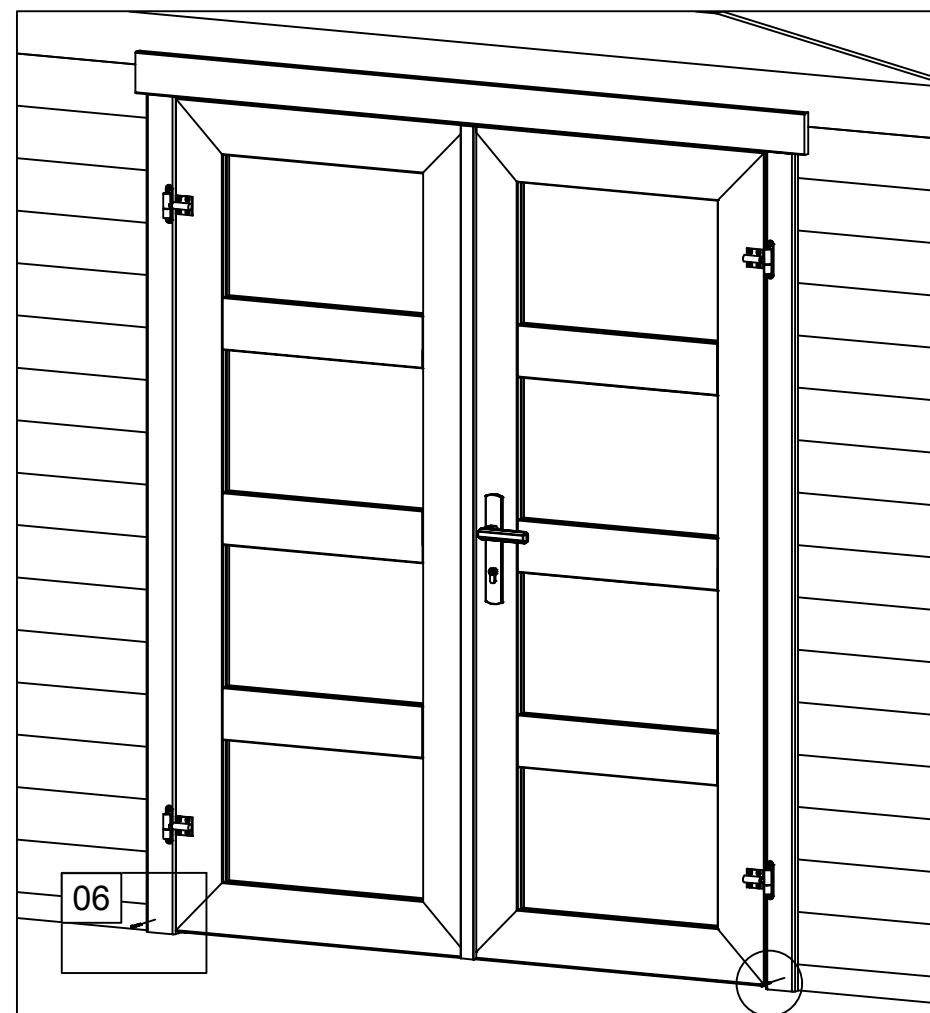
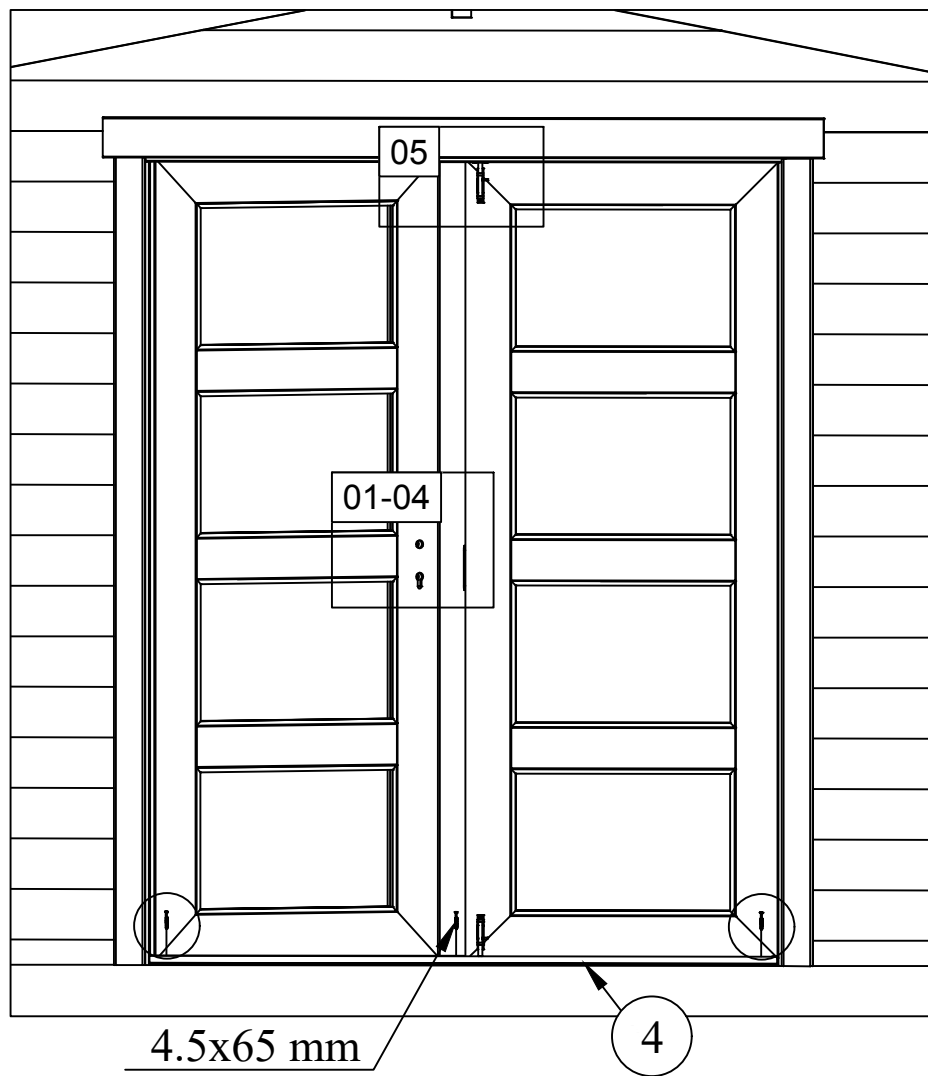

01

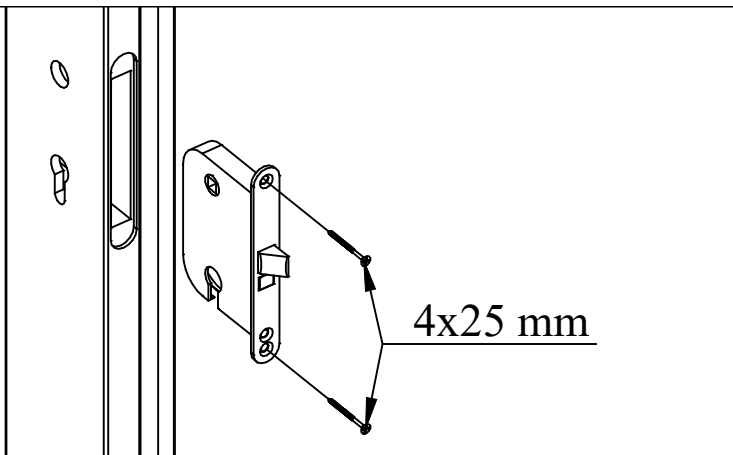

04

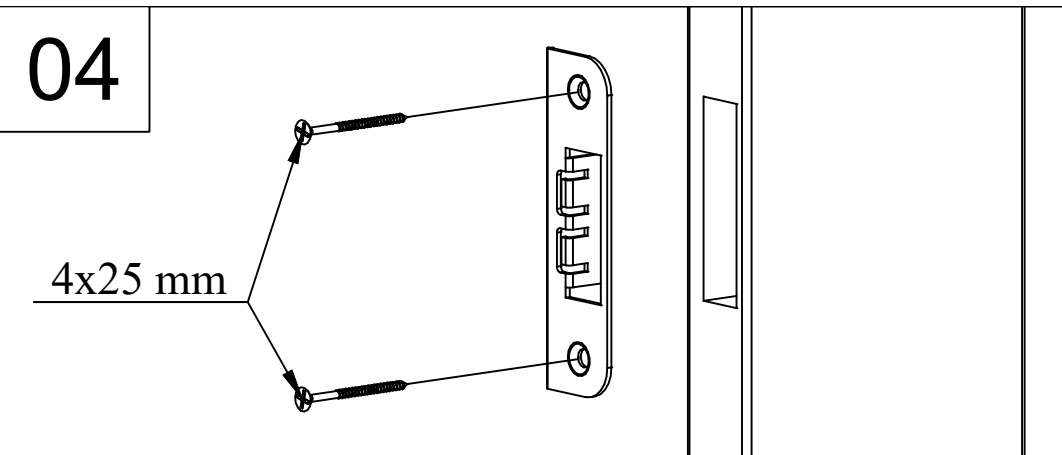

02

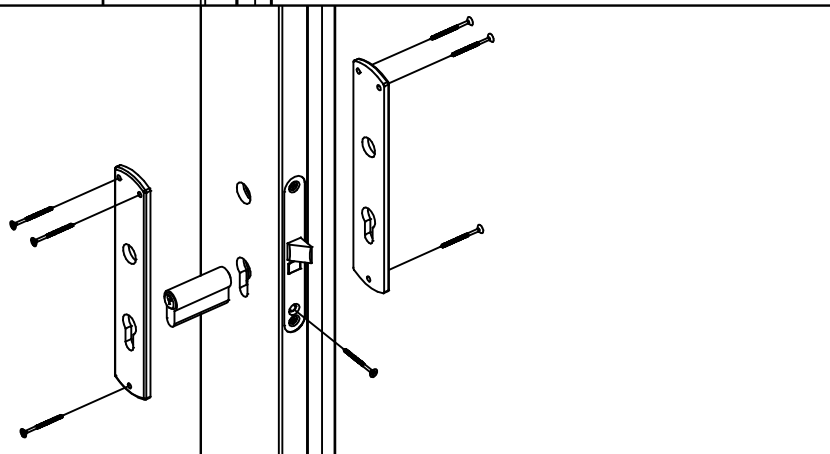

05

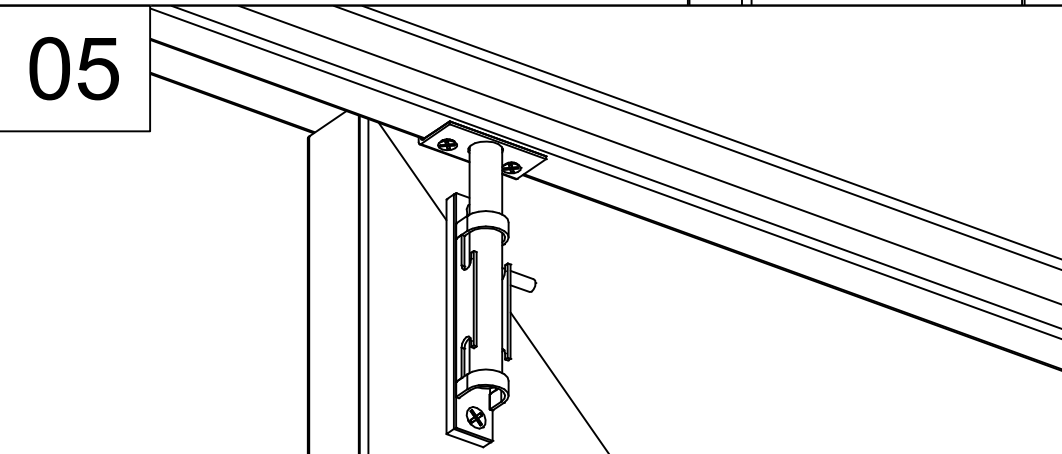

03

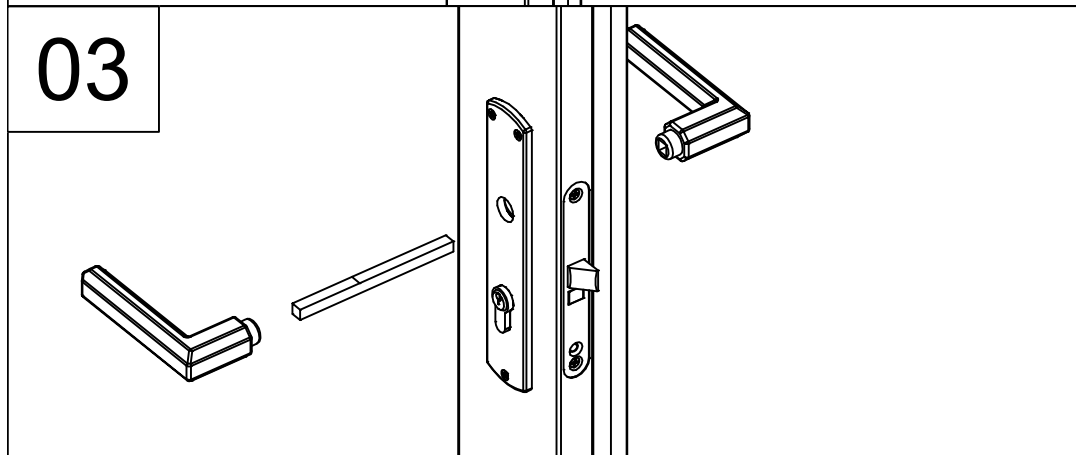

06

