

**Art. Nr.** 63728347, 93881655, 66106206, 88050365, 51032317,  
96164362, 13503938, 82960118, 19585714, 33883443,  
42018830, 45229931, 88572017, 99541769

## Gröde

open corner

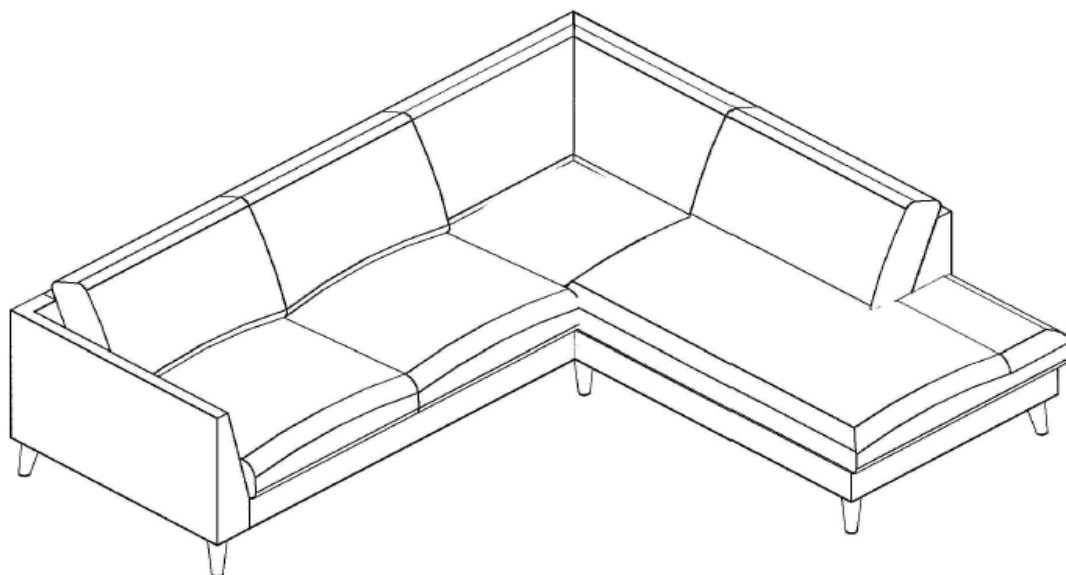

- |           |                                    |           |                                |
|-----------|------------------------------------|-----------|--------------------------------|
| <b>D</b>  | <b>Montageanleitung</b>            | <b>GB</b> | <b>Assembly instructions</b>   |
| <b>FR</b> | <b>Notice de montage</b>           | <b>IT</b> | <b>Istruzioni di montaggio</b> |
| <b>NL</b> | <b>Handleiding voor de montage</b> | <b>PL</b> | <b>Instrukcja montażu</b>      |
| <b>CZ</b> | <b>Montážní návod</b>              | <b>SK</b> | <b>Návod na montáž</b>         |
| <b>HU</b> | <b>Szerelési útmutató</b>          | <b>RO</b> | <b>Instrucțiuni de montaj</b>  |
| <b>TR</b> | <b>Montaj talimatı</b>             | <b>RU</b> | <b>Инструкция по монтажу</b>   |



**320 kg - max**

**LKZ 40937**

**Service • Usługa • Обслуживание • Servizio • Un service  
Serviciu • Služba • Servis • Szolgáltatás**

Name • Nom • Nome • Naam  
• Nazwa • Název • Názov  
• Név • Nume • Isim  
• Название

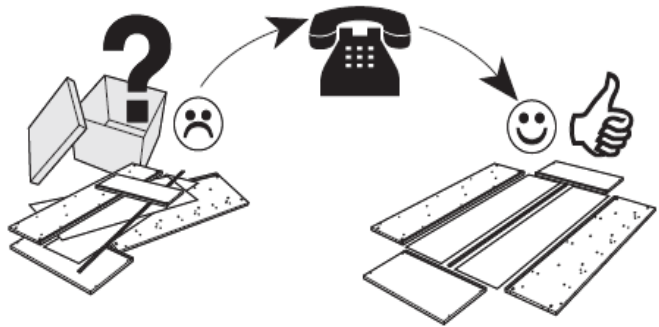

**Gröde**

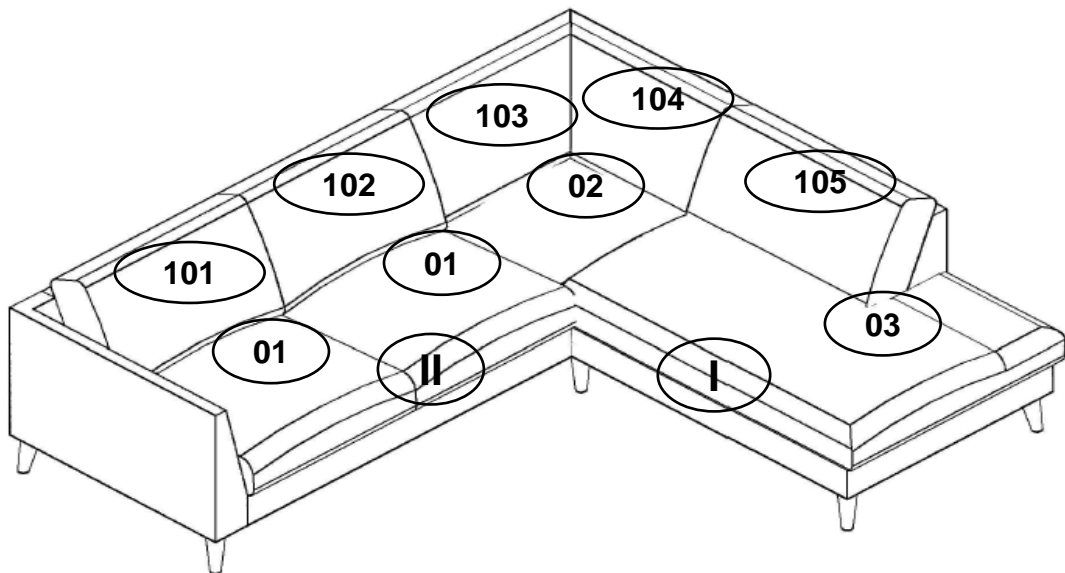
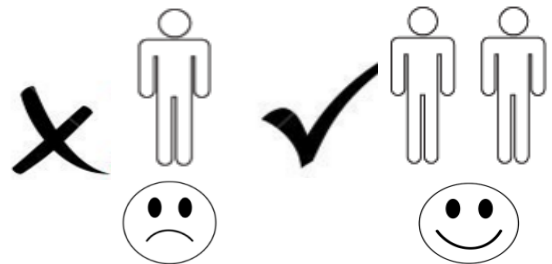
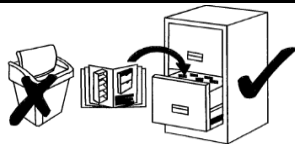

• Nr • No • N° • Номер • Č • Sz

63728347, 93881655, 66106206, 88050365,  
51032317, 96164362, 13503938, 82960118,  
19585714, 33883443, 42018830, 45229931,  
88572017, 99541769



<b>A</b>		<b>B</b>		<b>C</b>	
H- 145 x7		x21, 5x30		x7	

1

