

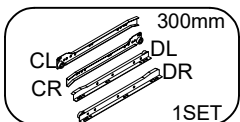

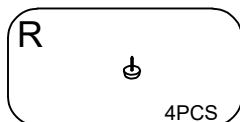
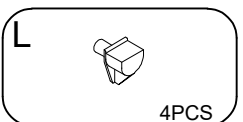
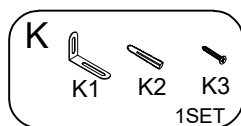
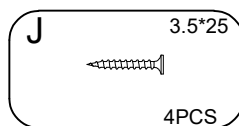
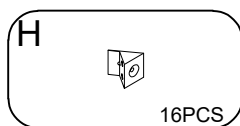
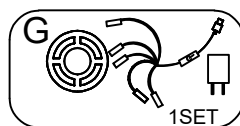
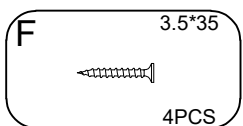
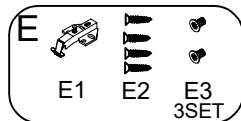
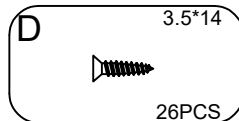
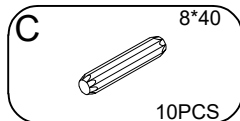
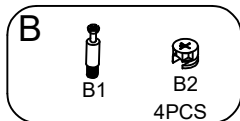
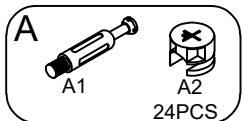
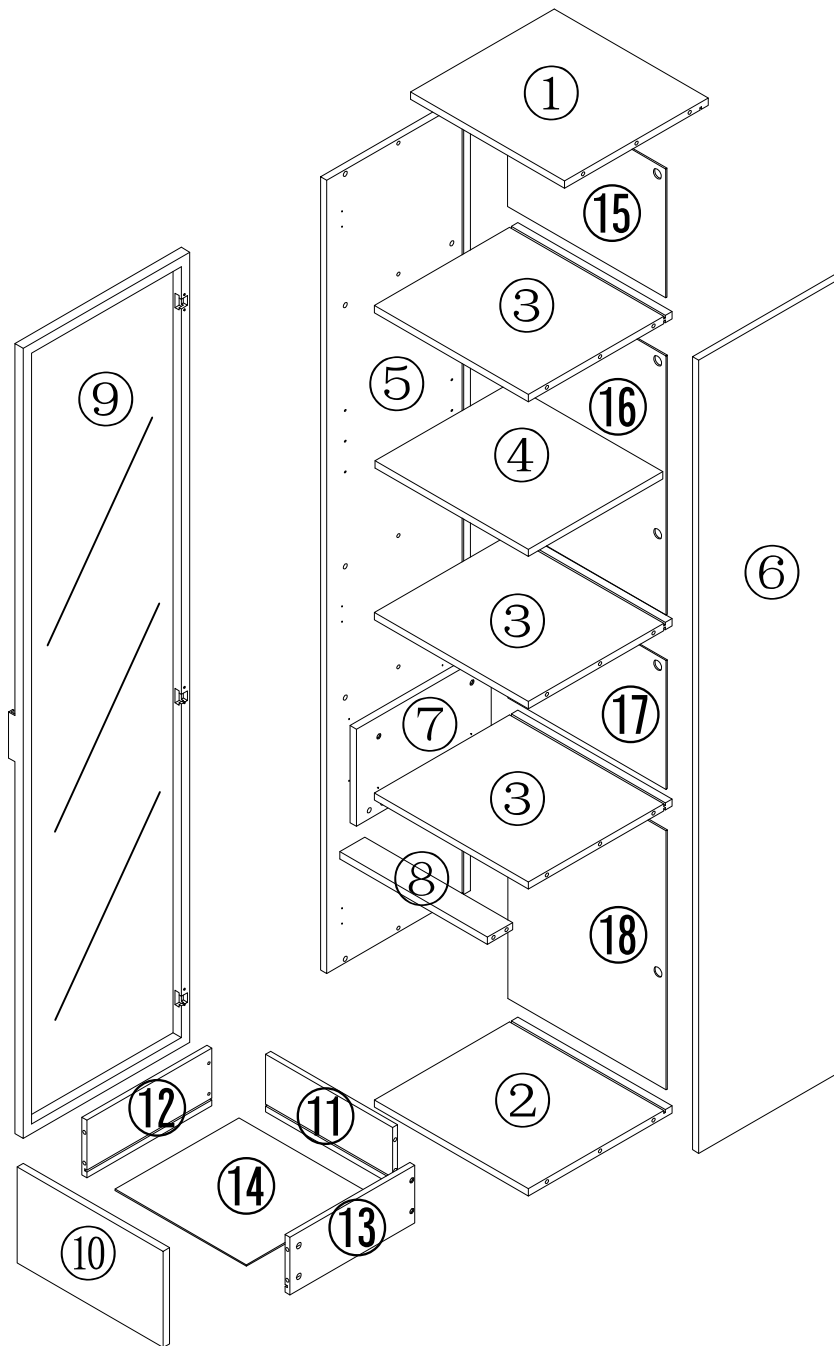

EN_IMPORTANT,RETAIN FOR FUTUREREERENCE:READ CAREFULLY.

FR_IMPORTANT:ALIREATTENTIVEMENTETA CONSERVER POUR CONSULTATIONULTERIEURE.

ES_IMPORTANTE,LEAY GUARDE PARA FUTURAS REFERENCIAS. DE WICHTIGISORGFALTIG LESEN UND FUR SPATER NACHSCHLAGEN AUFBEWAHREN.

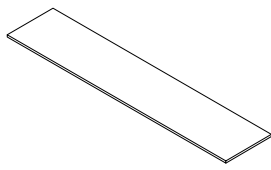
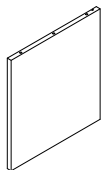
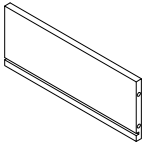
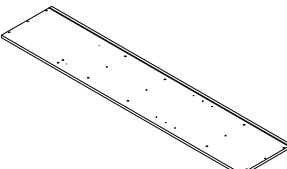
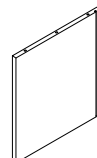
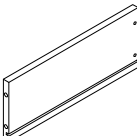
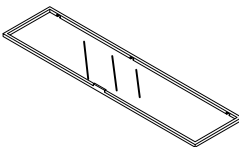
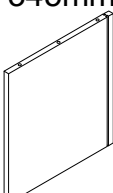
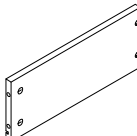
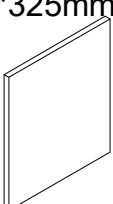
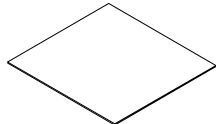
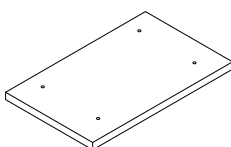
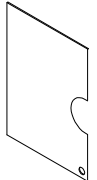
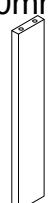
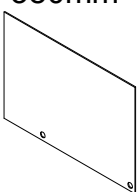
IT IMPORTANTEI CONSERVARE IL PRESENTE MANUALE PER FUTURO RIFERIMENTO E LEGGERLO ATTENTAMENTE.

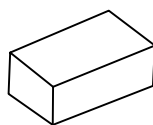

N656P248200S		N656P248201S			
NO.	QTY	NO.	QTY	NO.	QTY
⑤	1650*345mm  1PCS	①	370*345mm  1PCS	⑪	305*120mm  1PCS
⑥	1650*345mm  1PCS	②	370*345mm  1PCS	⑫	300*120mm  1PCS
⑨	1645*400mm  1PCS	③	370*345mm  3PCS	⑬	300*120mm  1PCS
		④	370*325mm  1PCS	⑭	315*297mm  1PCS
		⑦	202*324mm  1PCS	⑮	268*380mm  1PCS
		⑧	355*60mm  1PCS	⑯	539*380mm  1PCS
		⑩	351*200mm  1PCS	⑰	268*380mm  1PCS
		Hardware	 1PCS	⑱	539*380mm  1PCS

EN_It may be necessary to adjust the hinges so that the doors align. Use the instructions below as a guide.

FR_Il est parfois nécessaire d'ajuster les charnières pour un meilleur alignement des portes. Servez-vous des instructions ci-dessous comme guide.

ES_Puede que sea necesario ajustar los quicios de forma que se alineen las puertas. Use las instrucciones que aparecen debajo como guía.

DE_Möglicherweise müssen Sie die Scharniere so einstellen, dass die Türen ausgerichtet sind. Verwenden Sie die nachstehenden Anweisungen als Leitfaden.

IT_Potrebbe essere necessario regolare le cerniere in modo che le porte siano allineate. Per fare ciò attenersi alle istruzioni sottostanti.

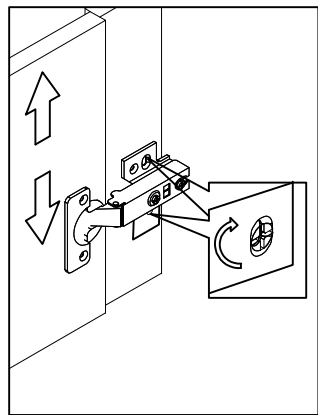

EN_To adjust the door vertically loosen the screw as shown and move up and down as needed.

FR_Si vous souhaitez régler la porte verticalement, desserrez la vis comme indiqué et déplacez la porte de haut en bas selon les besoins.

ES_Para ajustar la puerta verticalmente afloje el tornillo tal y como se muestra y muévalo hacia arriba o hacia abajo según sea necesario.

DE_Um die Tür vertikal auszurichten, lösen Sie die Schraube wie abgebildet und bewegen Sie sie nach Bedarf nach oben oder nach unten.

IT_Per allineare la porta verticalmente allentare la vite come mostrato e spostarla in alto o in basso secondo necessità.

EN_To adjust the gap from the door to the main frame turn the screw clockwise or anti-clockwise as needed.

FR_Si vous souhaitez ajuster l'ecart entre la porte et le cadre principal, tournez la vis dans le sens des aiguilles d'une montre ou dans le sens inverse, si nécessaire.

ES_Para ajustar el espacio desde la puerta al marco principal, gire el tornillo en sentido horario o antihorario según se necesite.

DE_Um den Abstand von der Tür zum Hauptrahmen auszurichten, drehen Sie die Schraube je nach Bedarf im oder gegen den Uhrzeigersinn.

IT_Per regolare lo spazio tra la porta e il telaio principale, avvitare o svitare la vite secondo necessità.

EN_To adjust the door laterally adjust the screw as shown by turning clockwise or anti-clockwise.

FR_Si vous souhaitez ajuster la porte latéralement, ajustez la vis comme indiqué en tournant dans le sens des aiguilles d'une montre ou dans le sens inverse des aiguilles d'une montre.

ES_Para ajustar la puerta lateralmente ajuste el tornillo tal y como se muestra girándolo en sentido horario y antihorario.

DE_Um die Tür seitlich auszurichten, stellen Sie bitte die Schraube wie abgebildet durch Drehen im oder gegen den Uhrzeigersinn ein.

IT_Per allineare la porta lateralmente regolare la vite come mostrato, avvitandola o svitandola

EN_Please fix other screws

FR_Merci de serrer les autres vis

ES_Fije los demás tornillos

DE_Befestigen Sie bitte die anderen Schrauben IT_Fissare le altre viti

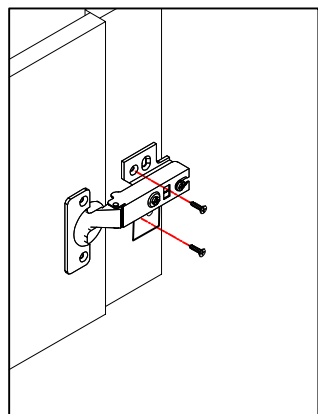

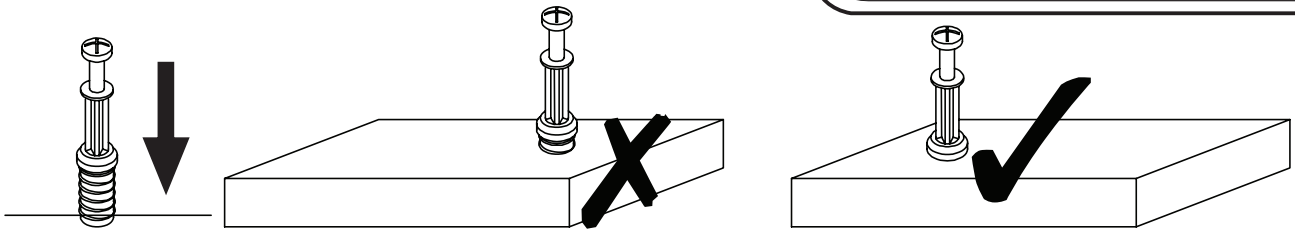

EN_QUICKFIT: Tighten quickfit until shoulder is flush with panel. Do not overtighten or undertighten.

FR_RACCORD RAPIDE: Faites serrer le raccord rapide jusqu'à ce que l'épaulement soit parfaitement encastré dans le panneau. Il ne faut ni trop serrer ni insuffisamment serrer.

ES_QUICKFIT: Apriete quickfit hasta que el hombro se descargue con el panel. NO lo sobreapriete ni lo apriete poco.

DE_QUICKFIT: Ziehen Sie den Quickfit fest, bis die Schulter mit der Platte bündig ist. Bitte nicht zu fest oder zu schwach anziehen.

IT_MONTAGGIO RAPIDO: Stringere il montaggio rapido fino a quando la spalla è a filo con il pannello, non stringere troppo o troppo poco.

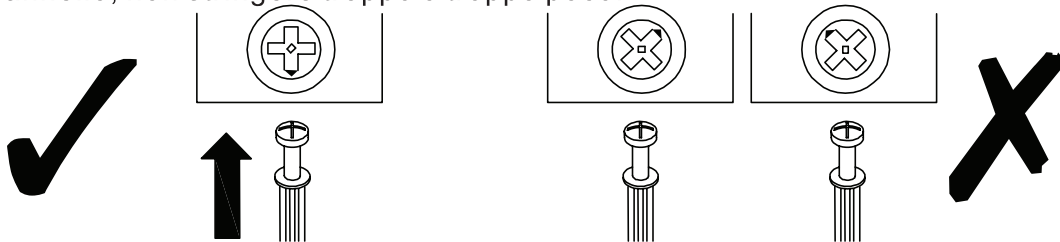

EN_CAM LOCK: When fitting cam lock, ensure starting position is correct before you insert connecting quickfit.

FR_SERRURE BATTEUSE: Avant d'insérer la serrure batteuse, veillez à la bonne orientation avant d'insérer le raccord rapide.

ES_CIERRE DE LA CÁMARA: Cuando instale el cierre de la cámara, asegúrese de que la posición de inicio es correcta antes de que inserte el quickfit conector.

DE_CAM-LOCK: Achten Sie bei der Montage des Cam-Locks auf die richtige Ausgangsposition, bevor Sie den Quickfit einsetzen.

IT_BLOCCAGGIO A CAMMA: Quando si monta il bloccaggio a camma, assicurarsi che la posizione iniziale sia corretta prima di inserire il montaggio rapido di collegamento.

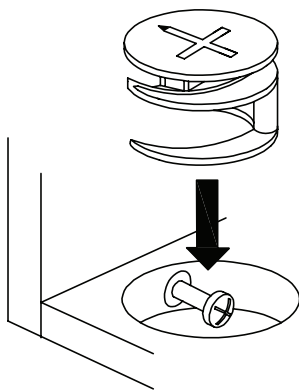

EN_Quickfit head should be in the centre of the cam lock when the two panels are joined.

Cam lock should be inserted before quickfit.

FR_Lorsque les deux panneaux sont assemblés, la tête du raccord rapide doit reposer au centre de la serrure batteuse. Il faut insérer la serrure batteuse avant le raccord rapide.

ES_El cabezal del quickfit debe estar en el centro del cierre de la cámara cuando se unan los dos paneles.

Se debe insertar el cierre de la cámara antes que el quickfit.

DE_Der Quickfit-Kopf sollte sich in der Mitte des Cam-Locks befinden, wenn die beiden Platten zusammengefügt sind.

Der Cam-Lock sollte vor dem Quickfit eingesetzt werden.

IT_La testa del montaggio rapido deve trovarsi al centro del bloccaggio a camma quando i due pannelli sono uniti.

Il Bloccaggio a Camma deve essere inserito prima del montaggio rapido.

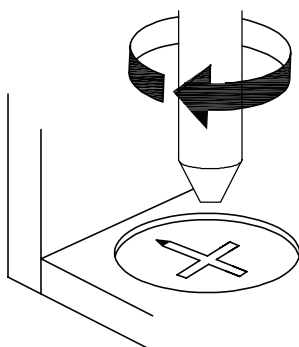

EN_Turn cam lock clockwise to tighten.

FR_Faites tourner la serrure batteuse dans le sens des aiguilles d'une montre pour la resserrer.





ES_Gire el cierre de la cámara en sentido horario para apretarlo.

DE_Drehen Sie den Cam-Lock im Uhrzeigersinn, um ihn festzuziehen.

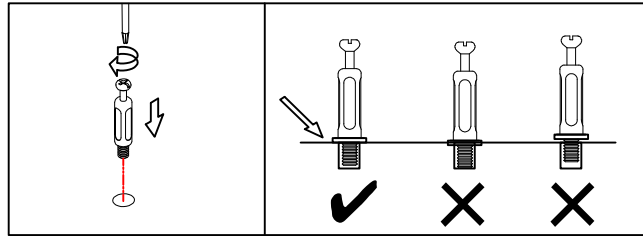
IT_Ruotare il bloccaggio a camma in senso orario per stringere.

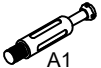
STEP 1



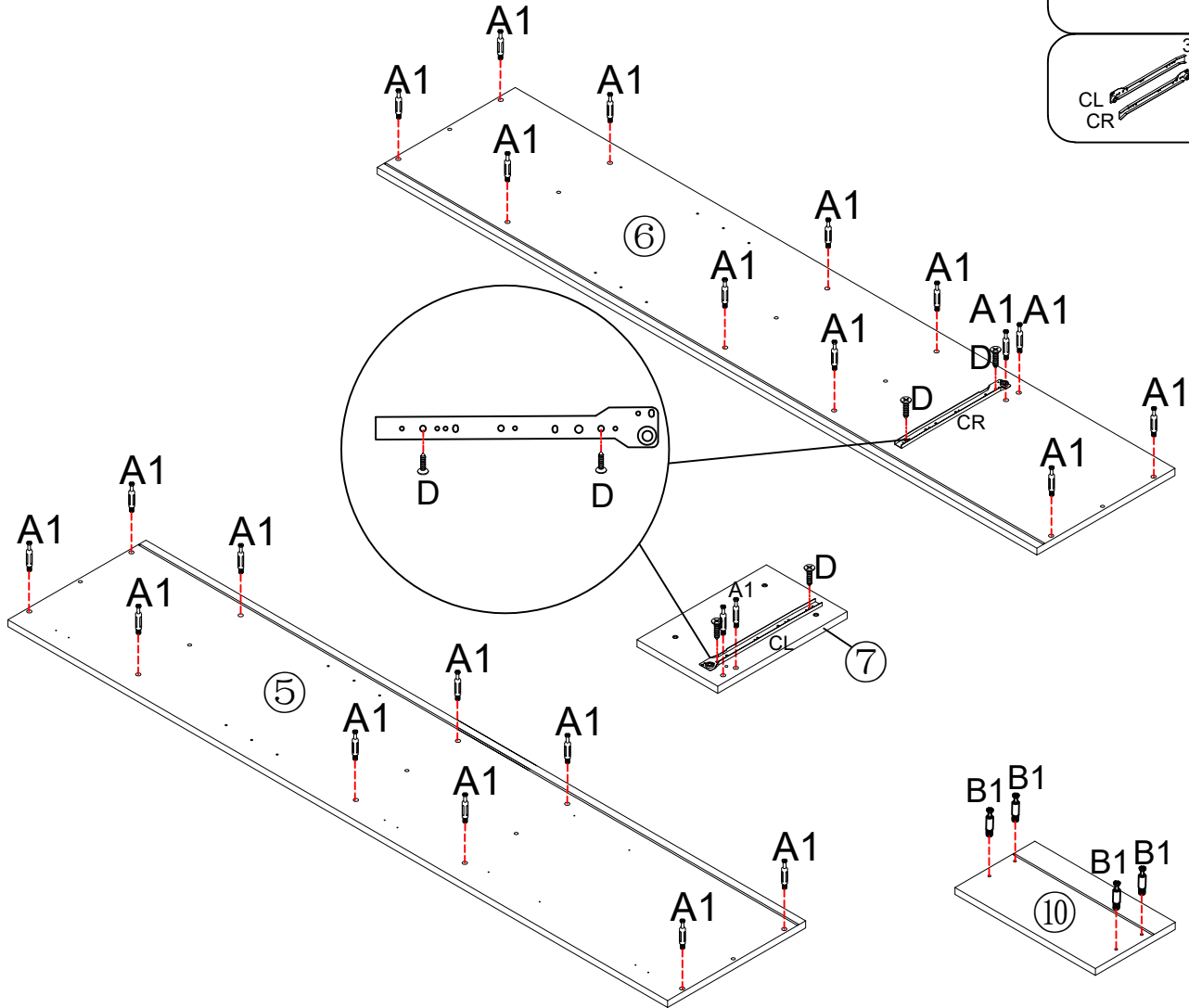

- A**  A1
24PCS
- B**  B1
4PCS
3.5*14
- D**  D
4PCS
300mm
- CL**  CL
CR  CR
1SET

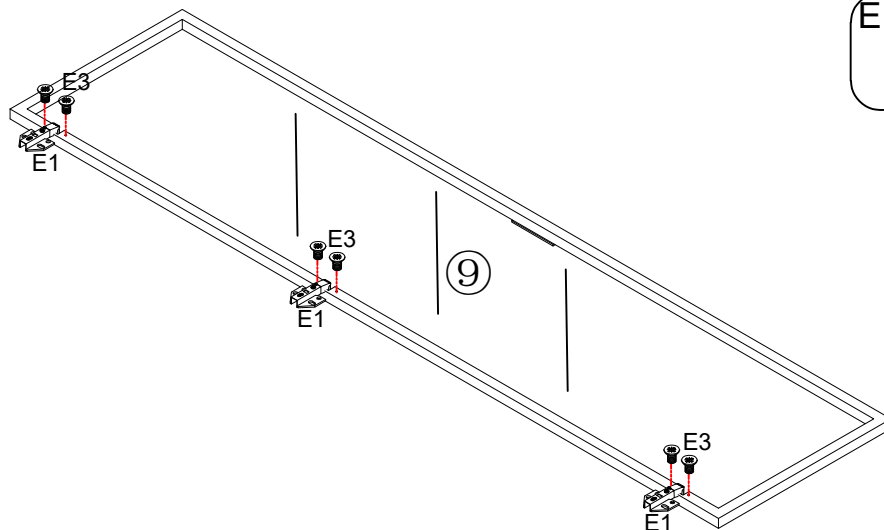

STEP 2



- E**  E1  E3
3SET

STEP 3

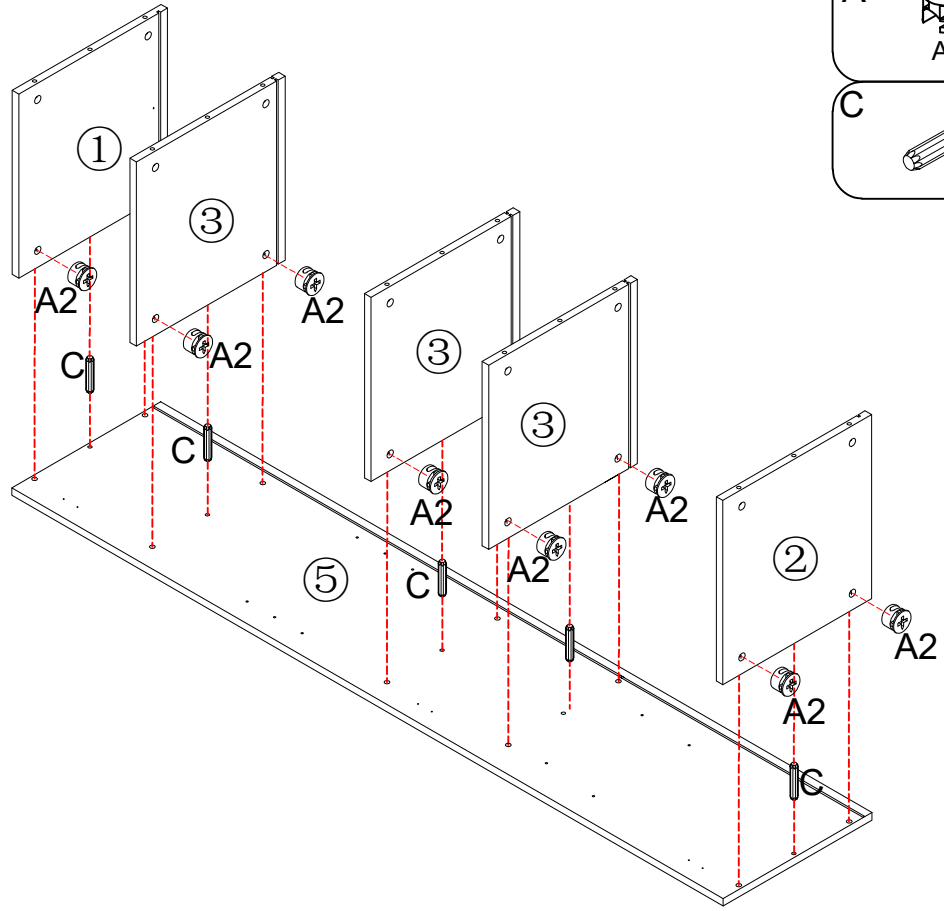

A		A2	10PCS
C		8*40	5PCS

STEP 4

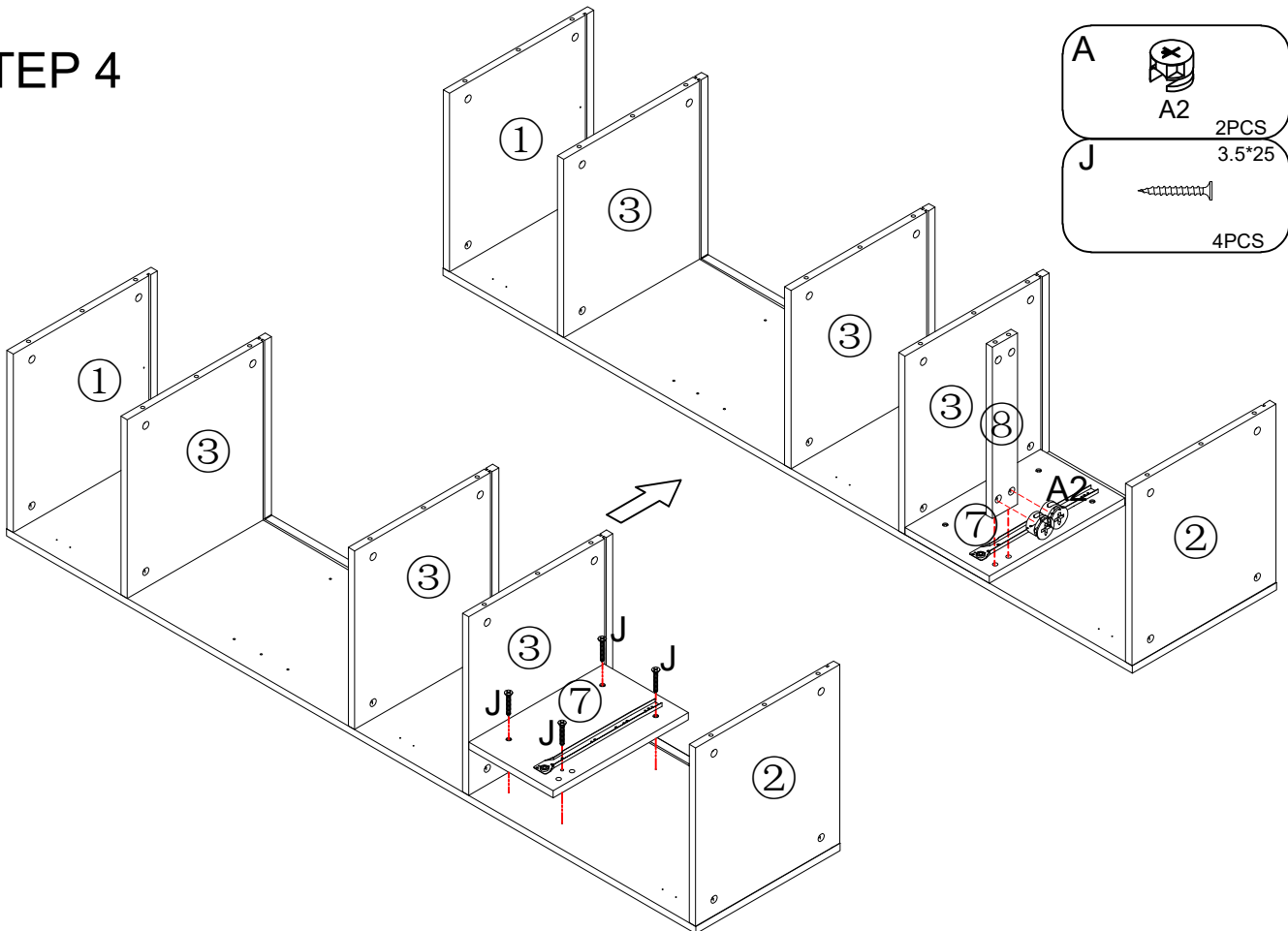

A		A2	2PCS
J		3.5*25	4PCS

STEP 5

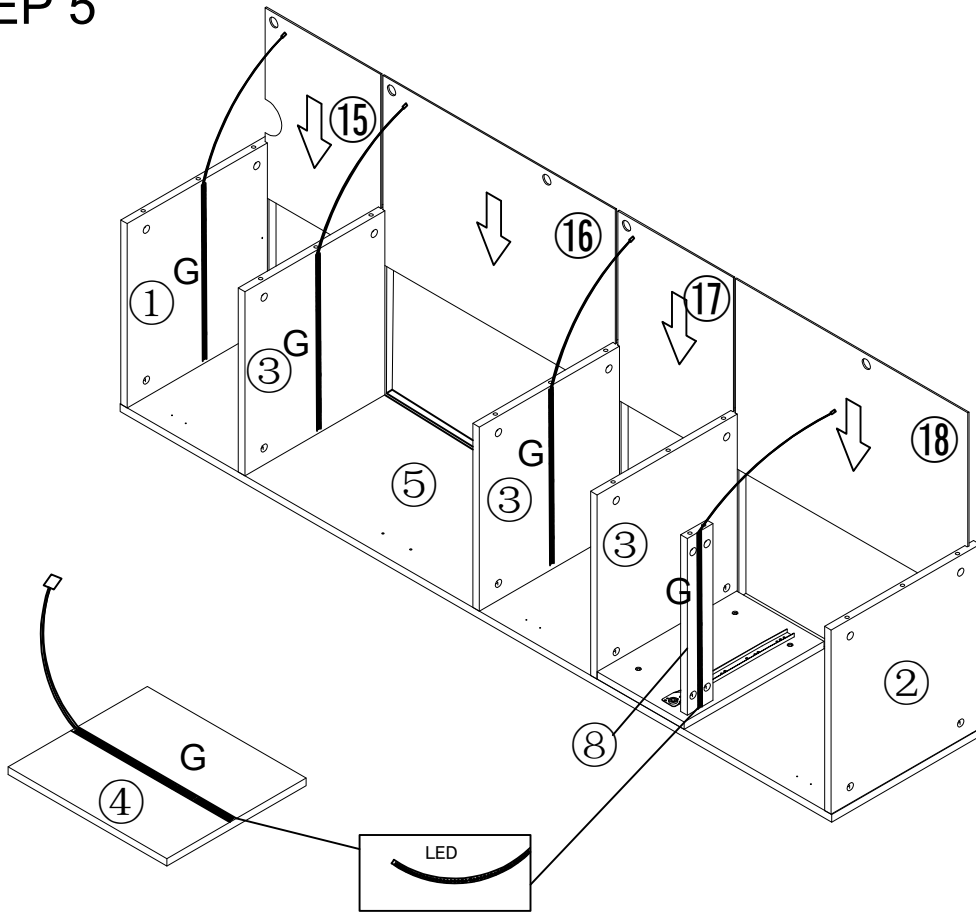
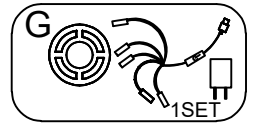



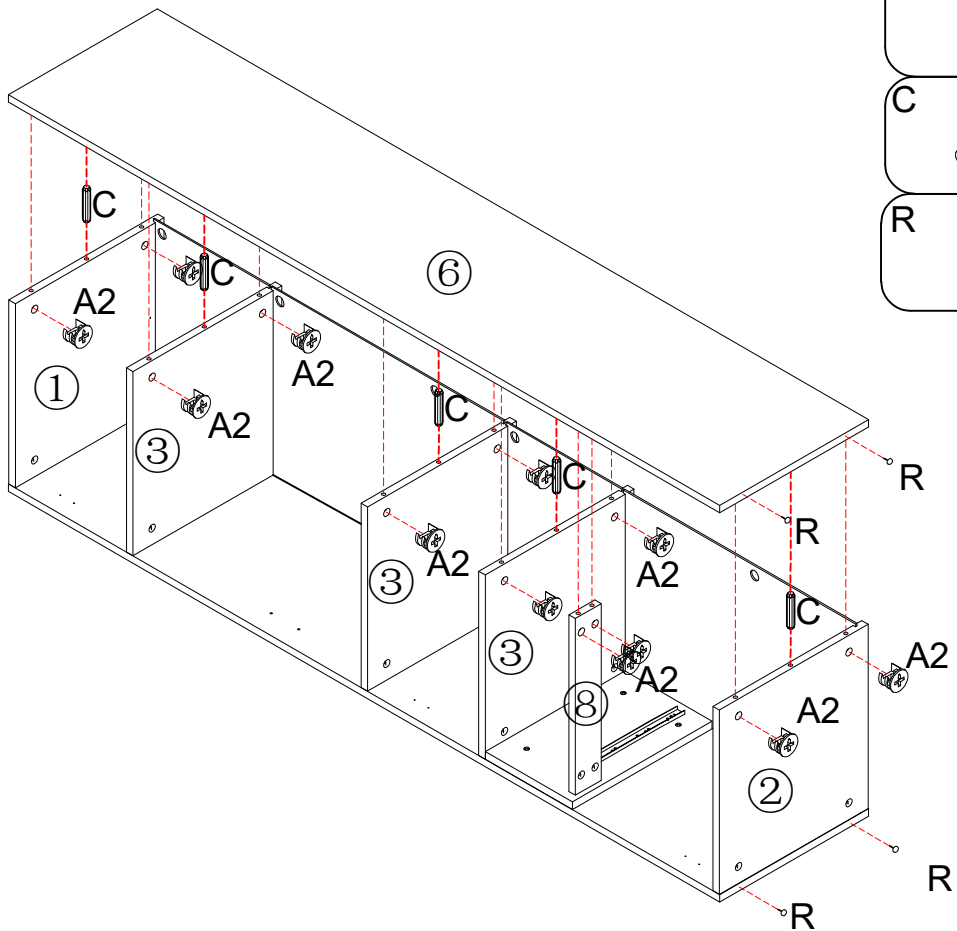
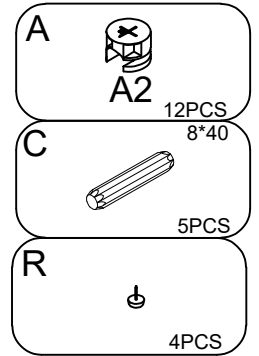

STEP 6

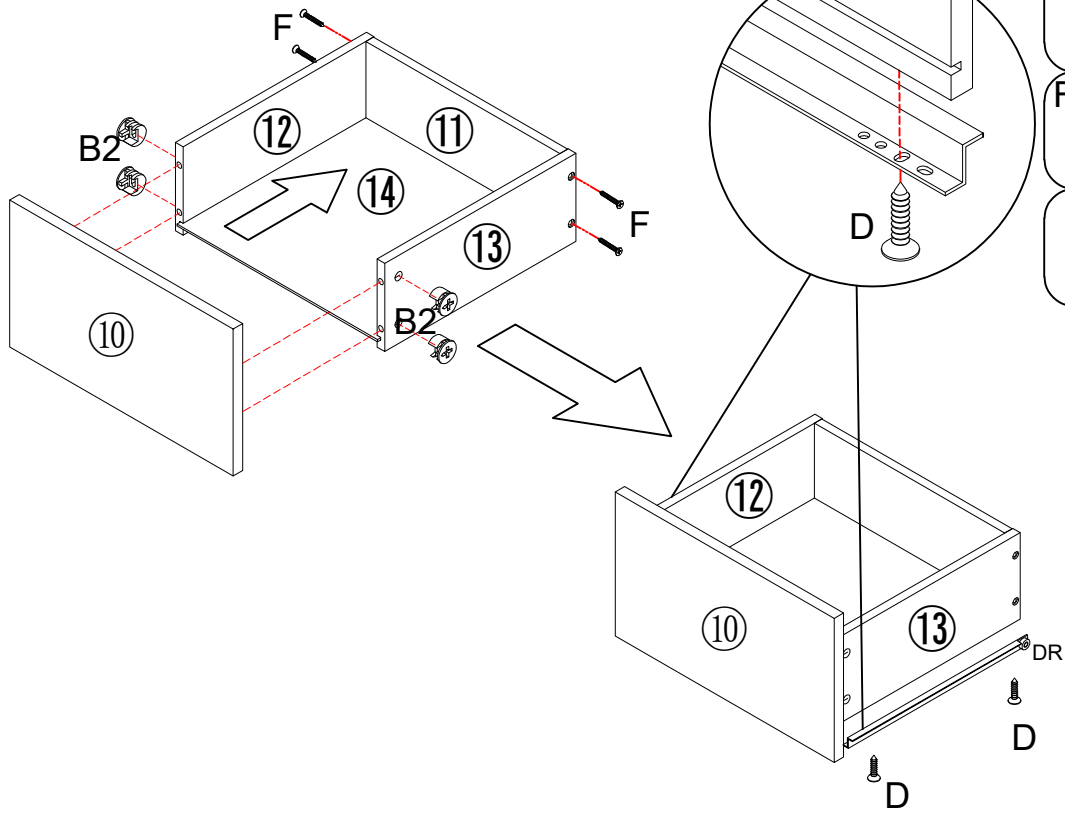



STEP 7

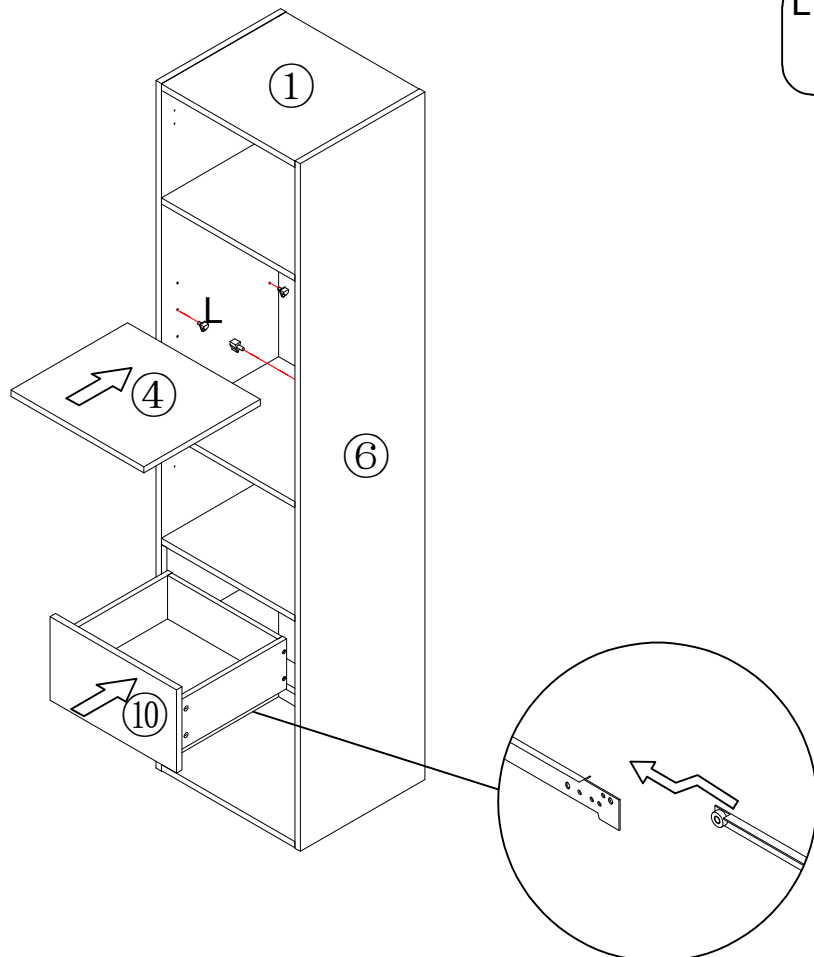

- B**  **B2** 4PCS
- D**  **D** 4PCS
- F**  **F** 4PCS
- DL**  **DL** 300mm
- DR**  **DR** 1SET

STEP 8



- L**  **L** 4PCS

STEP 9

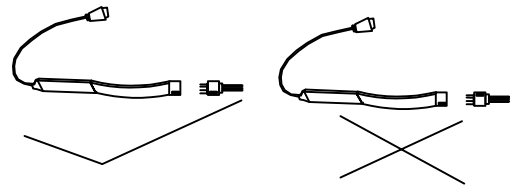
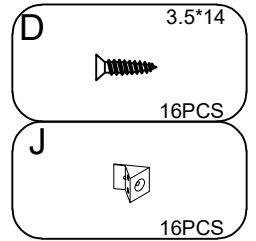
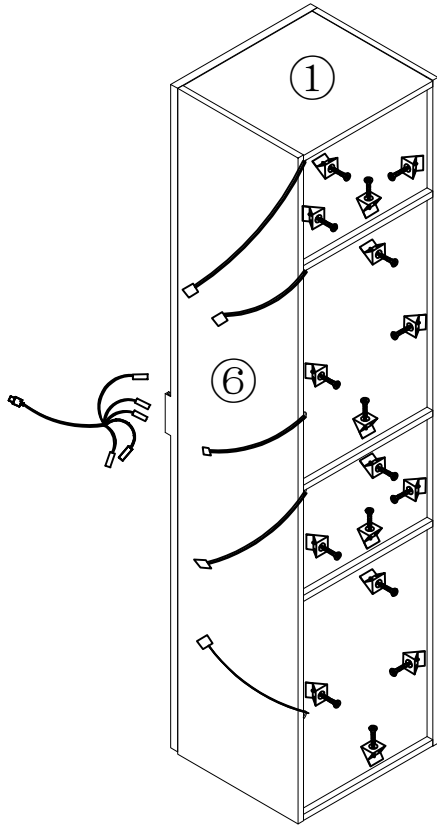

UK: The connection of light stripe
 DE: Die Verbindung von Lichtstreifen
 FR: La connexion de la bande lumineuse
 IT: La connessione della striscia di luce
 ES: La conexión de la franja de luz

STEP 10

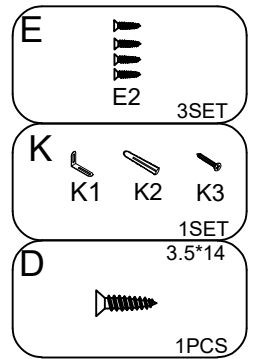
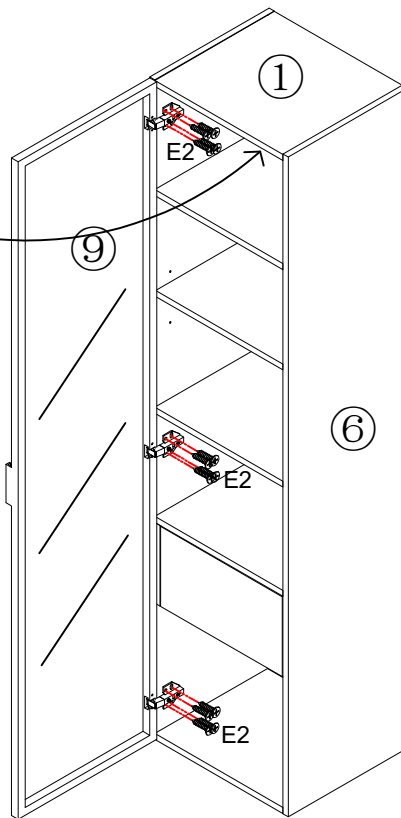
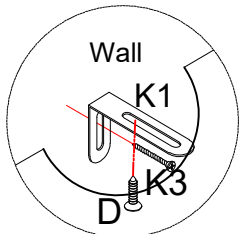
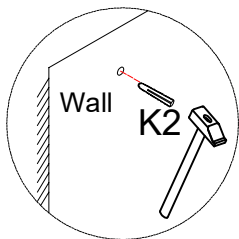
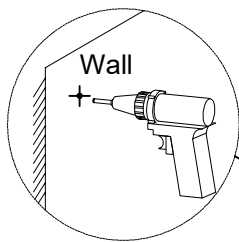

Wall