

APULIA
8141/2501
2501/8142

F/B

220121

- | | | | |
|-----------|--|-----------|---|
| D | MONTAGEANLEITUNG BEDIENUNGSANLEITUNG | GB | ASSEMBLY INSTRUCTIONS INSTRUCTION MANUAL |
| NL | HANDLEIDING VOOR DE MONTAGE GEBRUIKSAANWIJZING | PL | INSTRUKCJA MONTAŻU INSTRUKCJA OBSŁUGI |
| TR | MONTAJ TALIMATI KULLANIM KLAVUZU | RU | ИНСТРУКЦИЯ ПО МОНТАЖУ ИНСТРУКЦИЯ ПО ЭКСПЛУАТАЦИИ |
| RO | INSTRUCȚIUNI DE INSTALARE INSTRUCȚIUNI DE UTILIZARE | IT | ISTRUZIONI DI MONTAGGIO MANUALE DI ISTRUZIONI |
| FR | NOTICE DE MONTAGE MANUEL INSTRUCTIONS | SK | MONTÁŽNY NÁVOD NÁVOD NA POUŽITIE |
| HU | KÖZGYŰLÉS UTASÍTÁSOK KEZELÉSI UTASÍTÁS | CZ | MONTÁŽNÍ NÁVOD NÁVOD K POUŽITÍ |
| SI | NAVODILA ZA MONTAŽO NAVODILA ZA UPORABO | PT | INSTRUÇÕES DE MONTAGEM MANUAL DO USUÁRIO |
| ES | INSTRUCCIONES DE MONTAJE MANUAL DEL USUARIO | HR | UPUTE ZA MONTAŽU UPUTE ZA UPOTREBU |

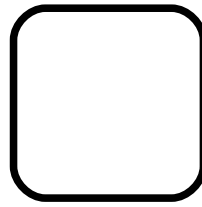
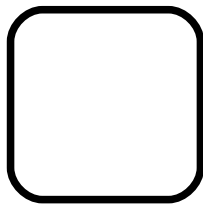

0019

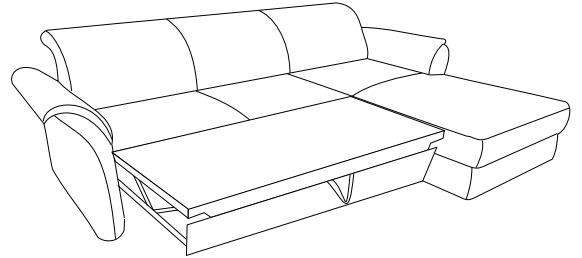
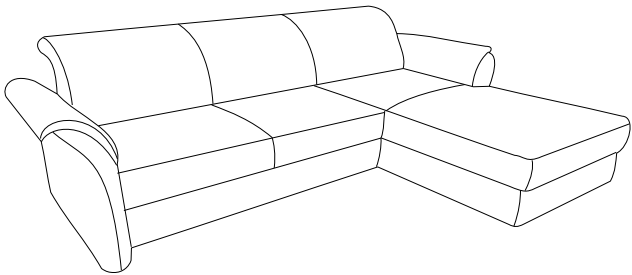

0019

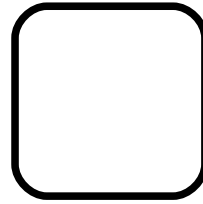
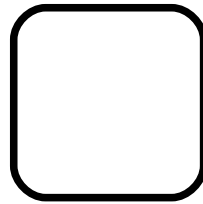

0089

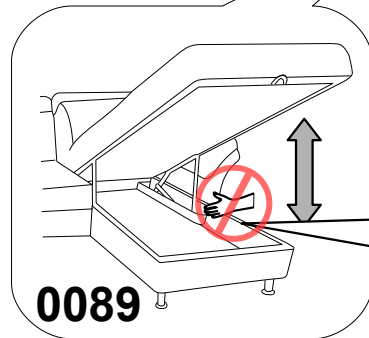
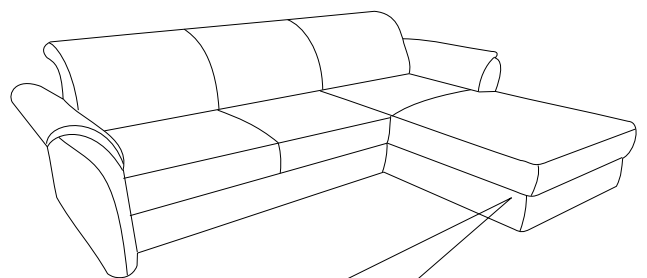
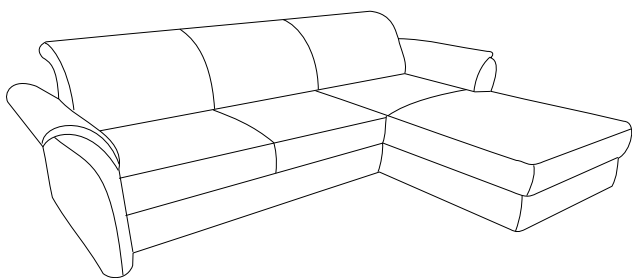
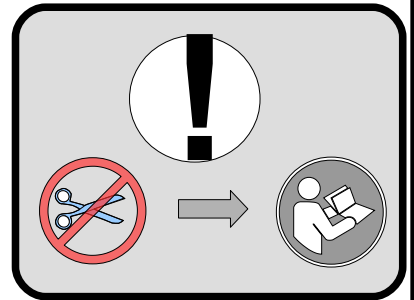

0089



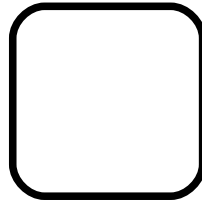
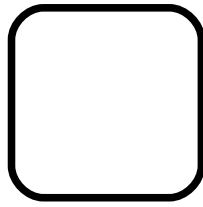

0090

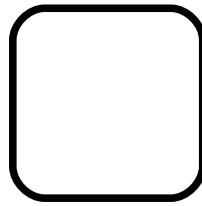
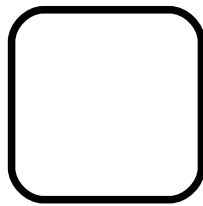
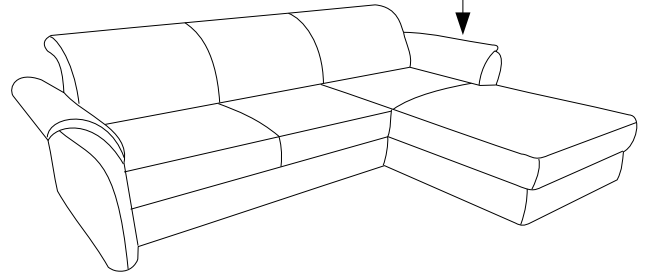
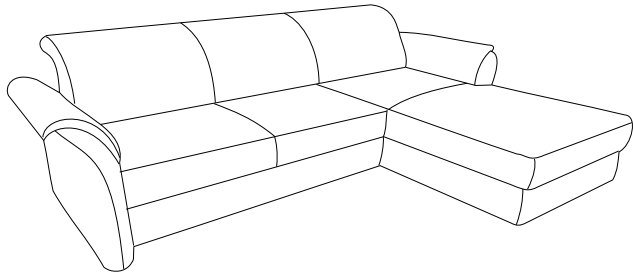
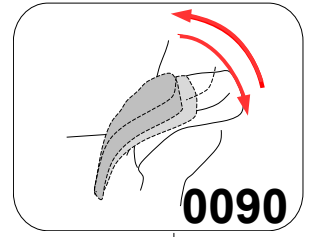

0090

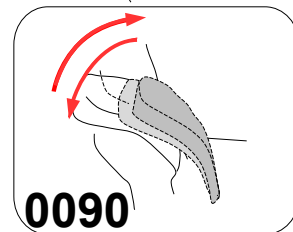
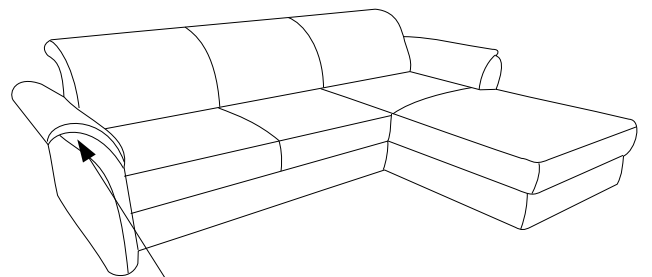
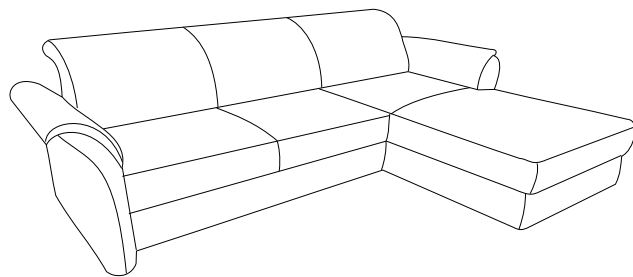

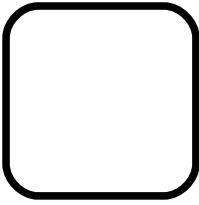
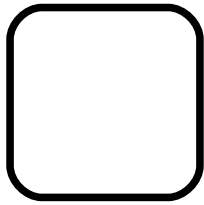

0064

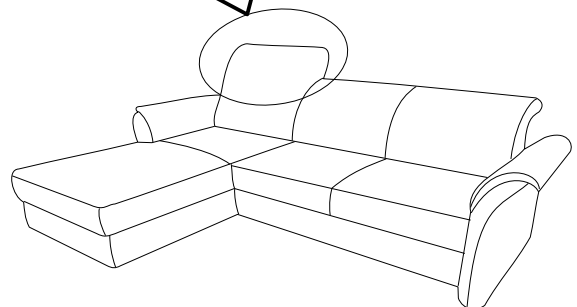
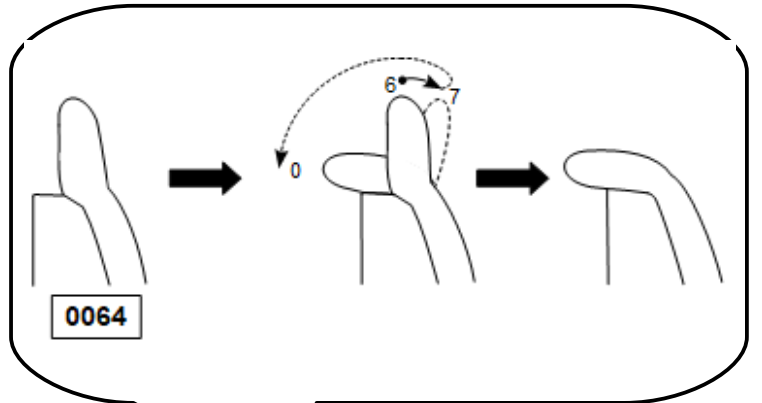
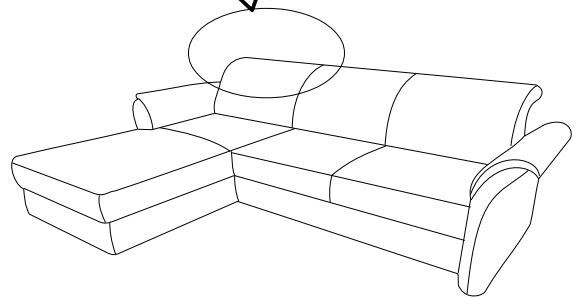
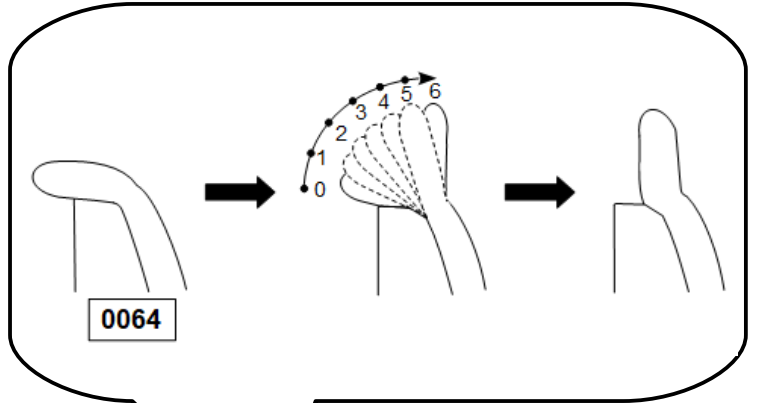
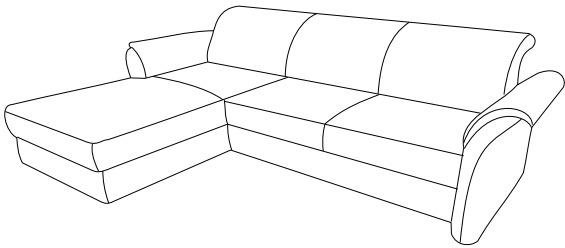

L

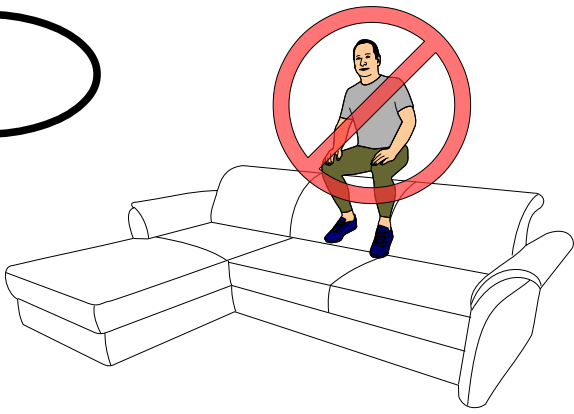



R

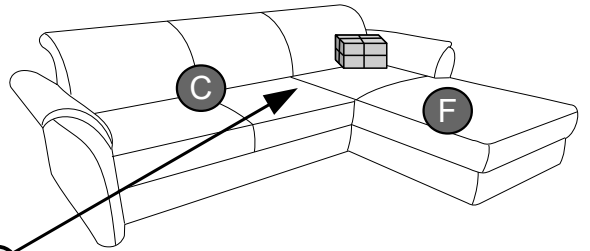
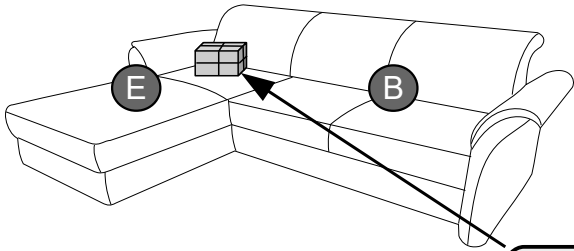

0
10
20
30
40
50
60
70
80
90
100
110
120
130
140
150
160
170
180
190
200



| | | |
|---|---|------|
| s H-90 | g H-90 | [mm] |
|  |  | |
| X3 | X1 | |

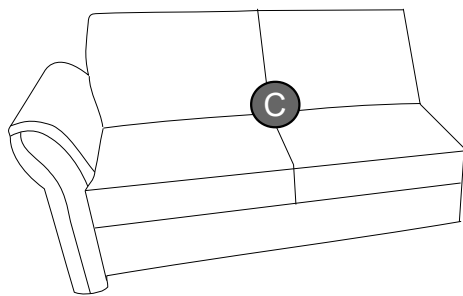
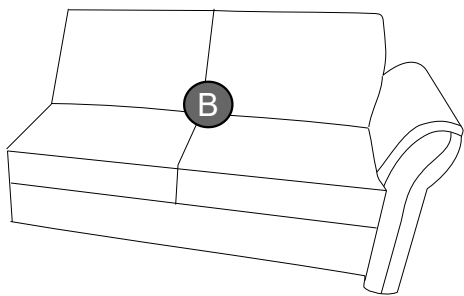
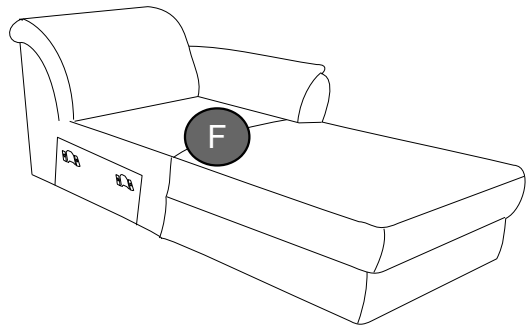
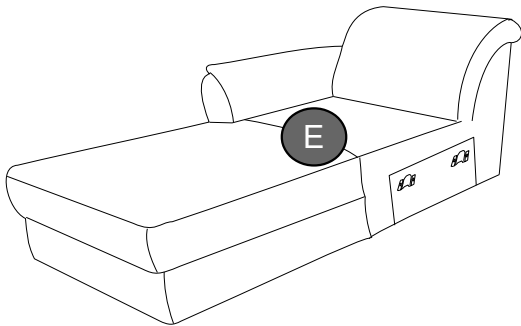

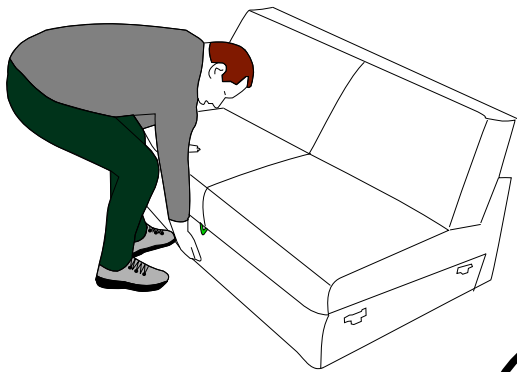

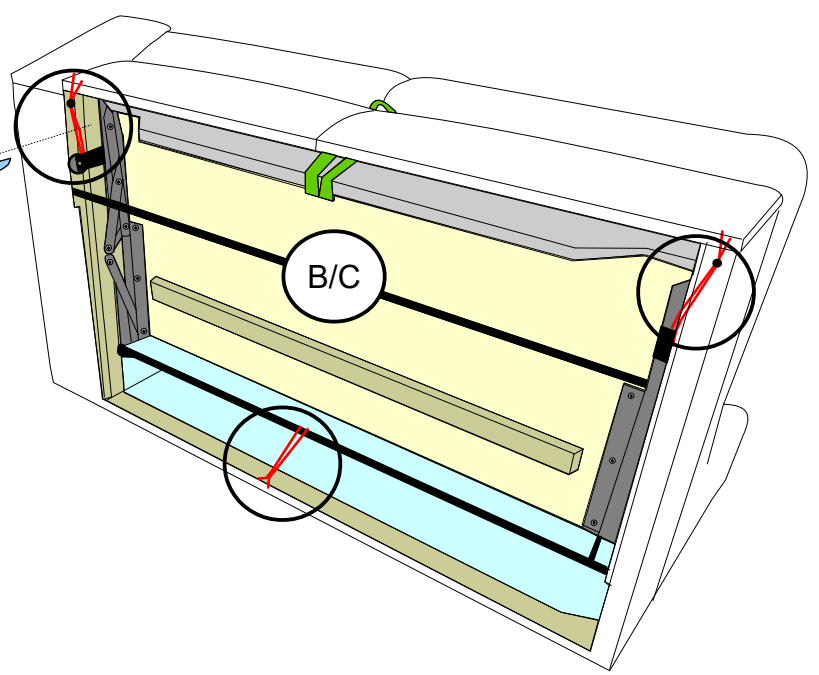
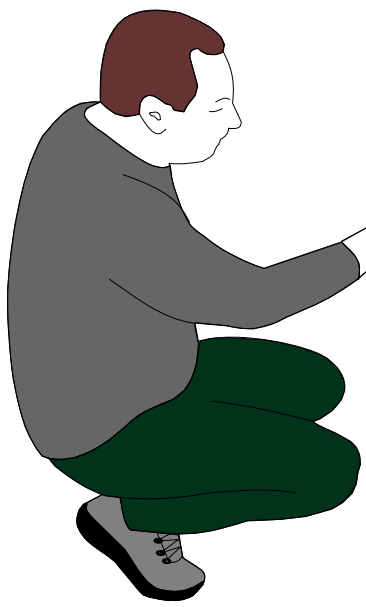

90°



0019

| | |
|---|---|
| s H-90  | g H-90  |
| X3 | X1 |

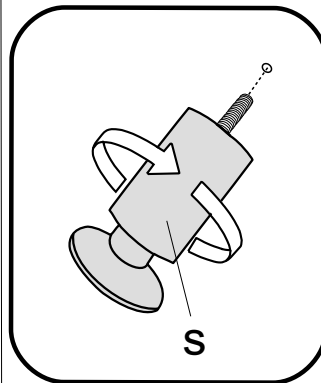
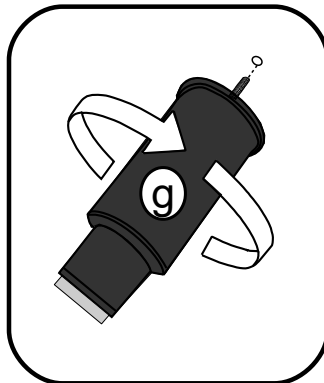
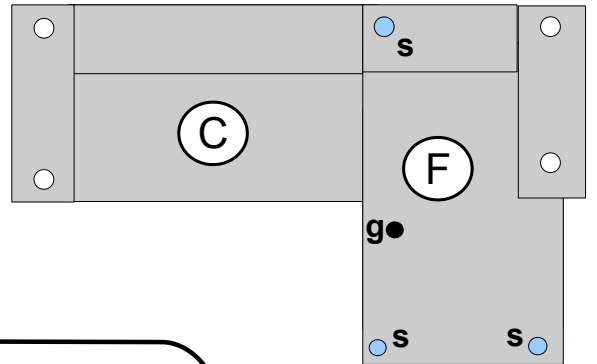
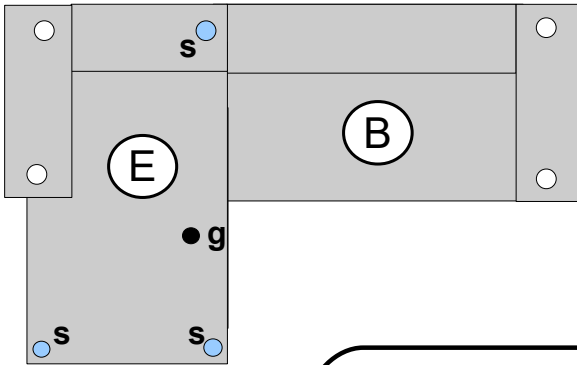
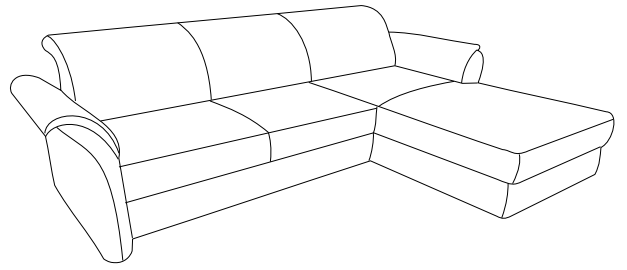
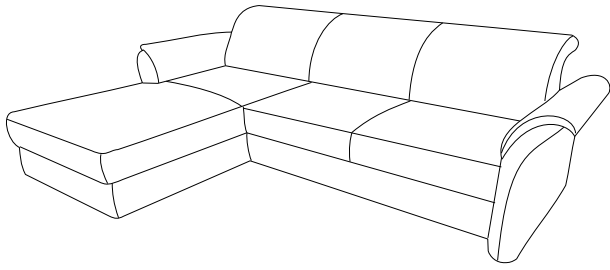

90 mm

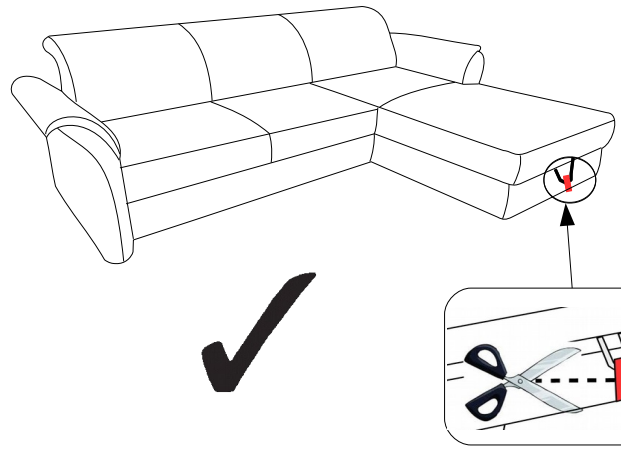
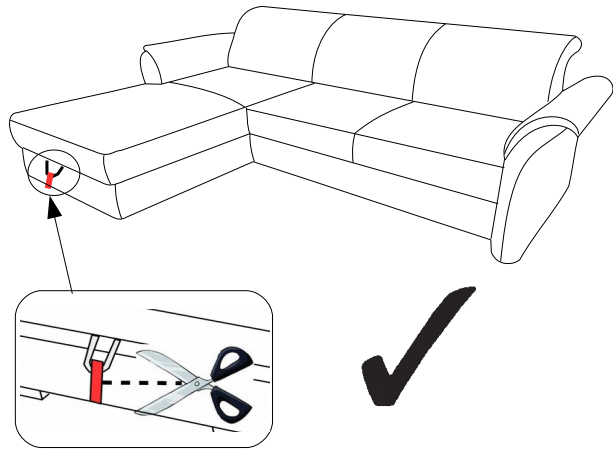
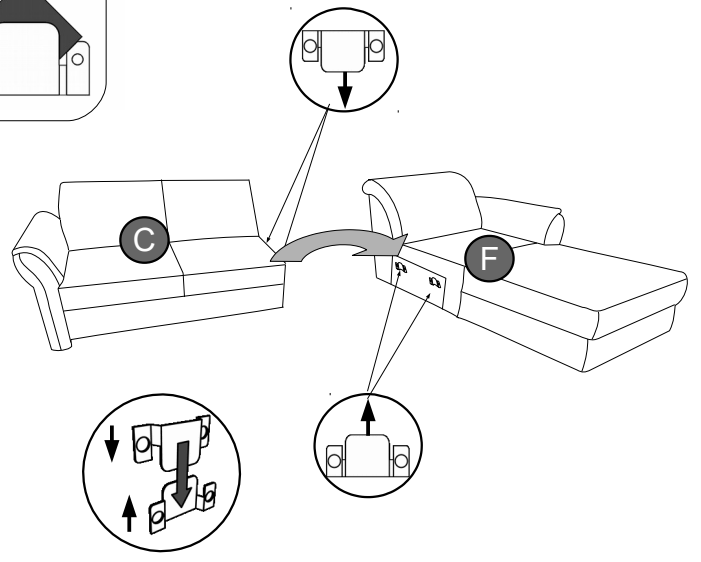
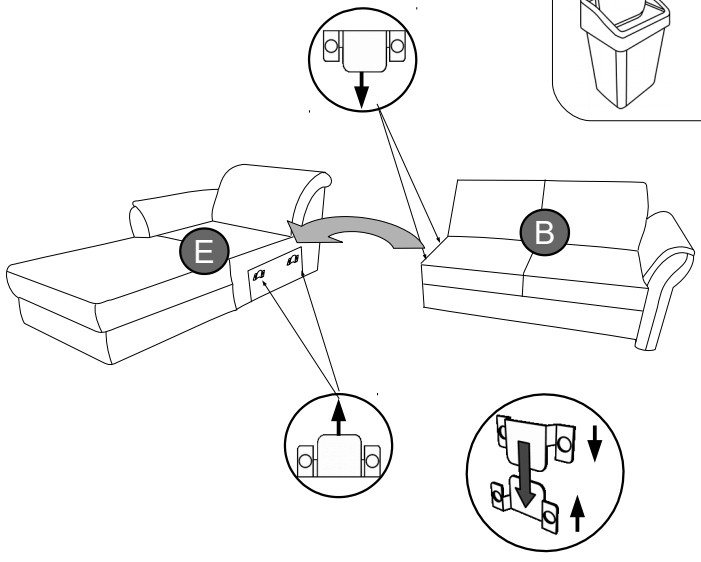
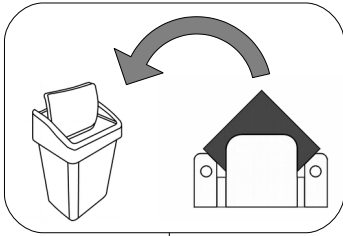

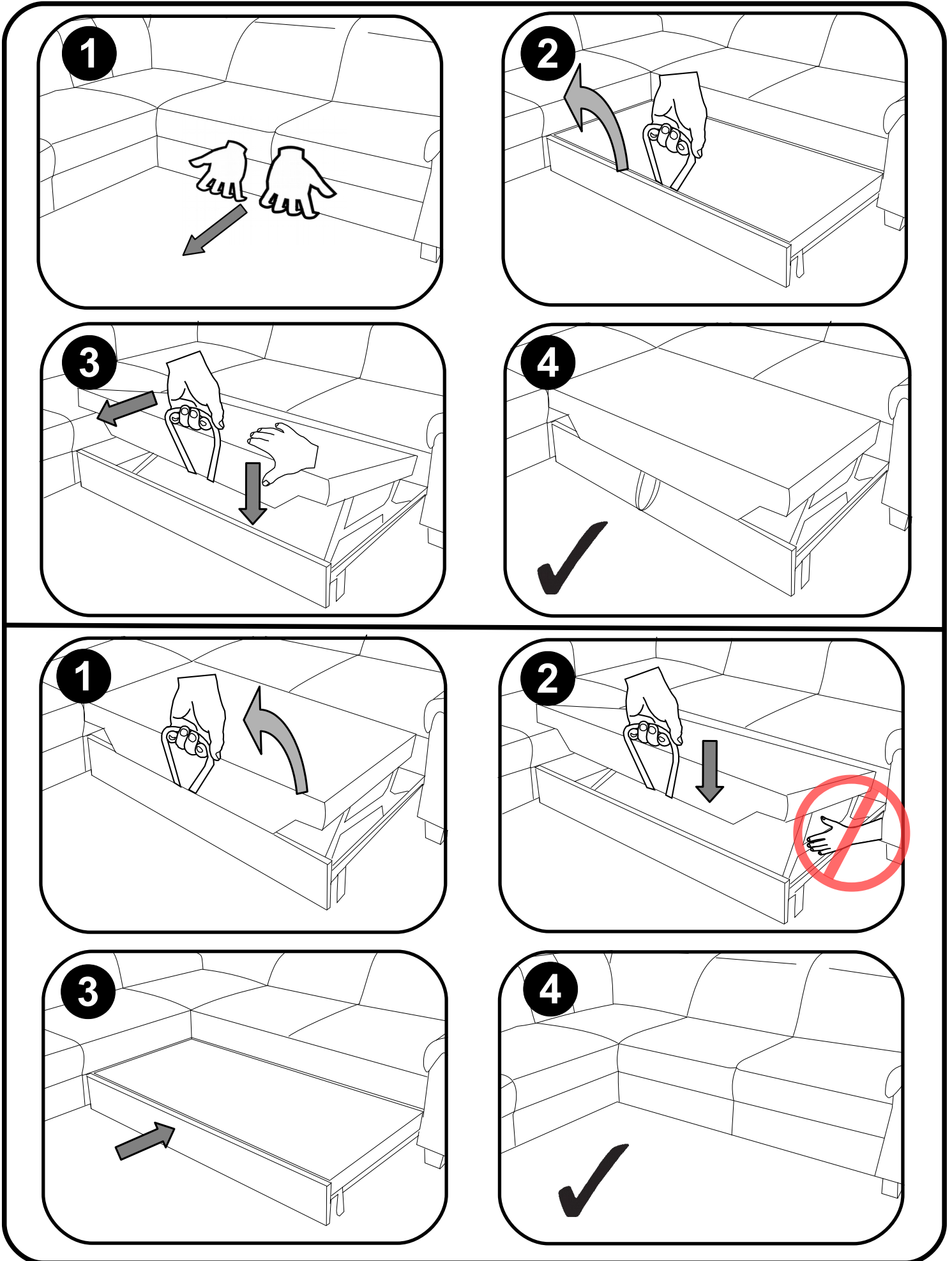
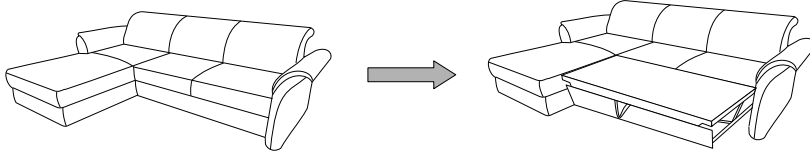

Name · Naam · Nazwa · İsim · Название · Nume · Nome · Název · Názov ·
 Název · Neve

APULIA

Typ · Type · Tip · Тип · Tipo · Típus

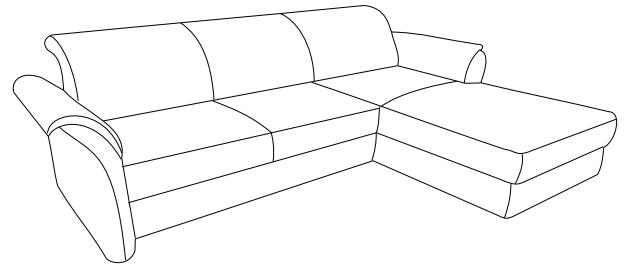
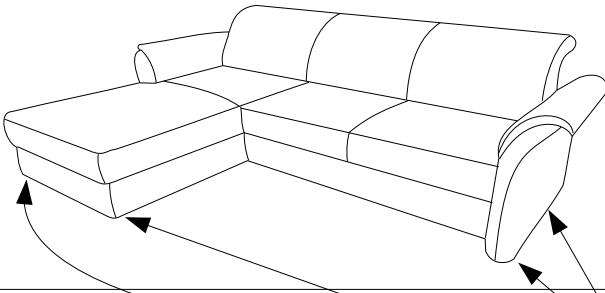
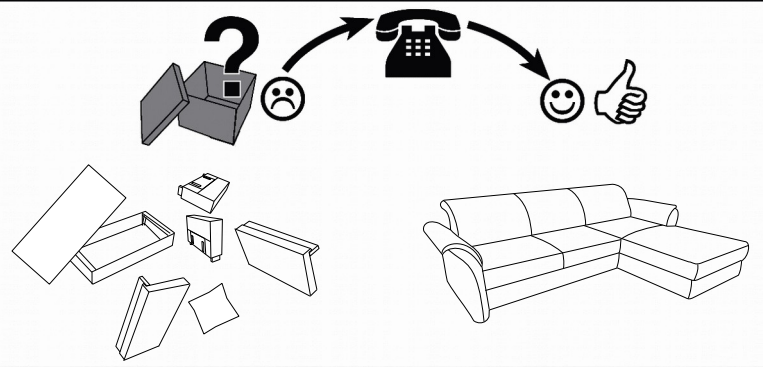
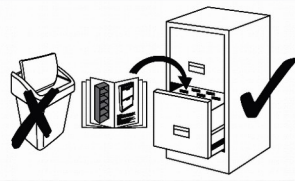

| | | | |
|--------------------|--------------------|--------------------|------|
| s H- 90 | z H- 26 | g H- 90 | [mm] |
|--------------------|--------------------|--------------------|------|

