

Domeo 6
Art. Nr. 4424919
1/27

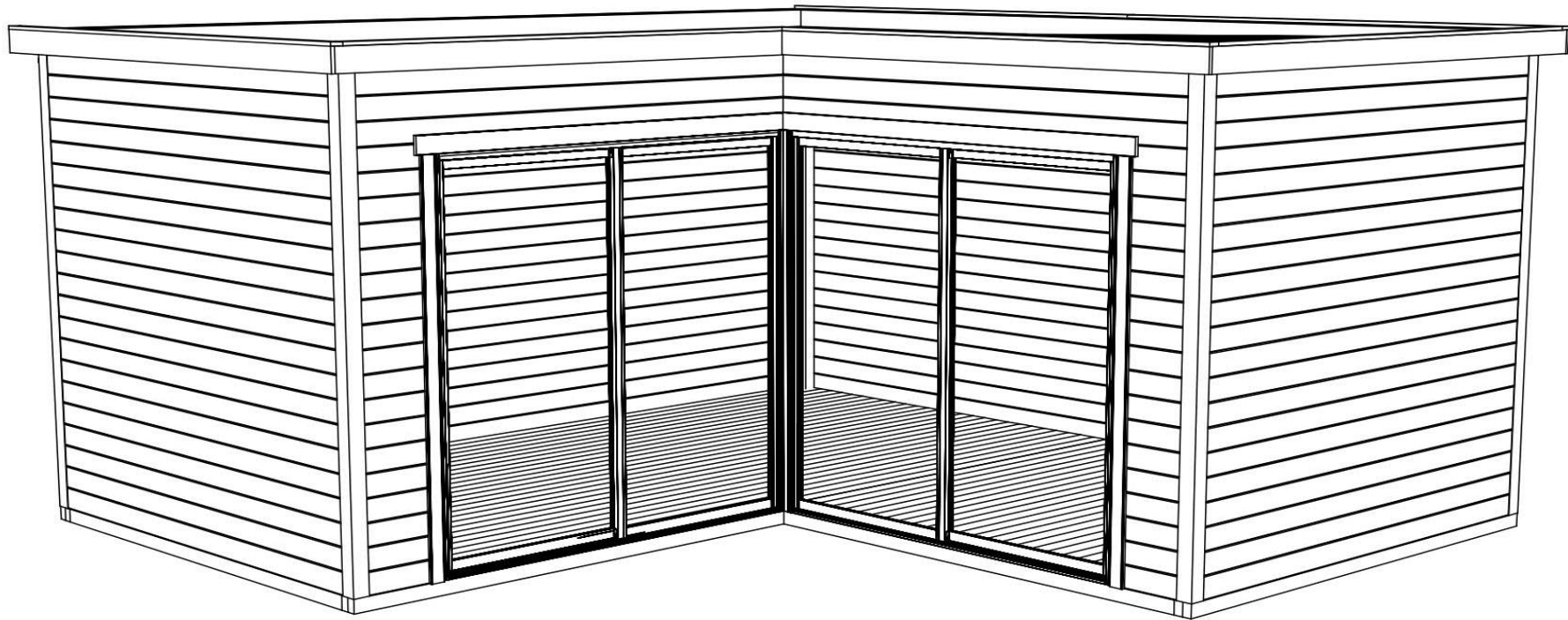

Art. Nr. 4424919

Groundplan - Grundplan - Plan de masse -
Planimetria - Plattegrond - Põhiplaan

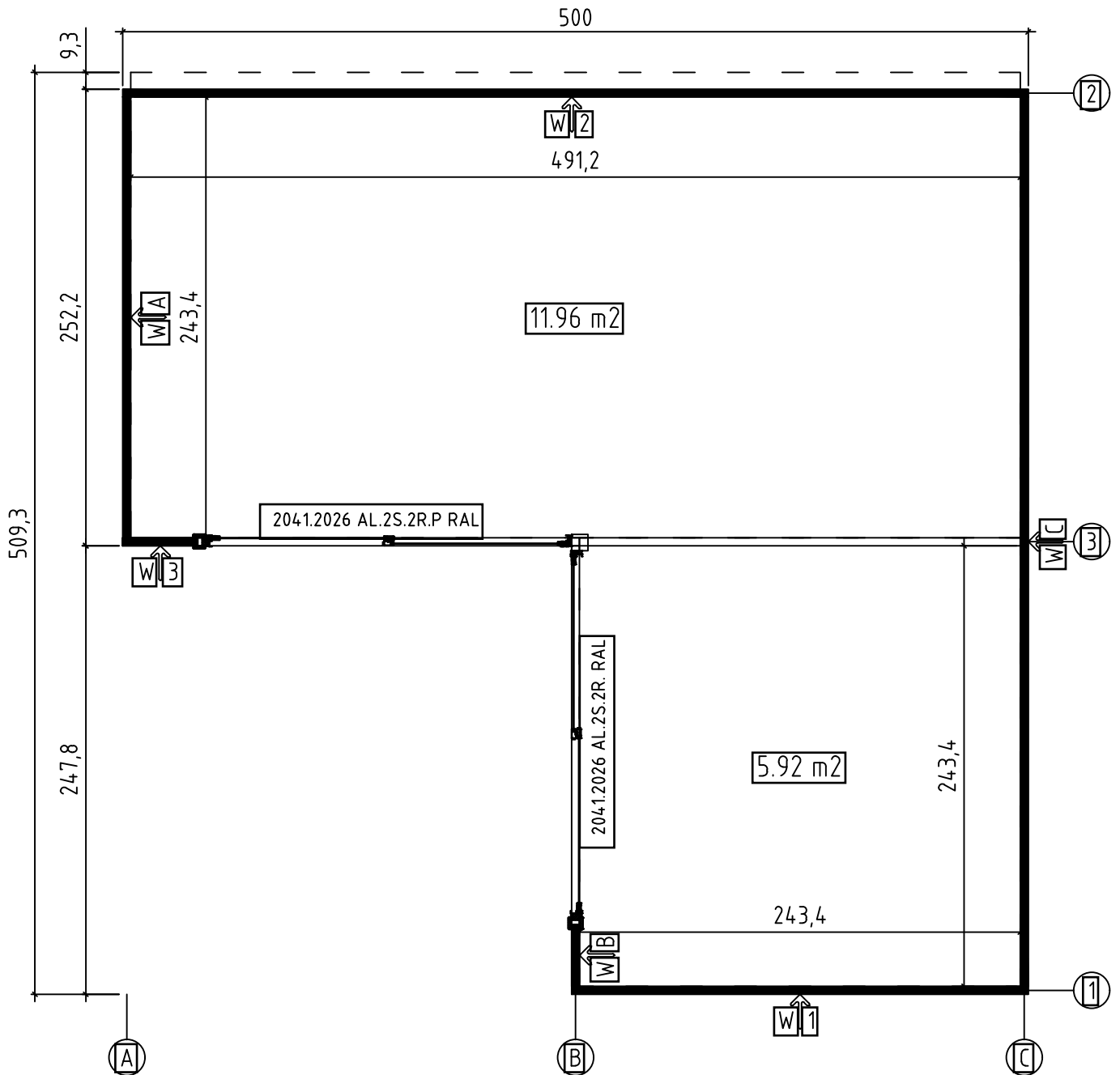

12.03.2020

2/27

Foundation - Fundament - Fondation - Fundamenta - Fundering -
Immutatud alusraam

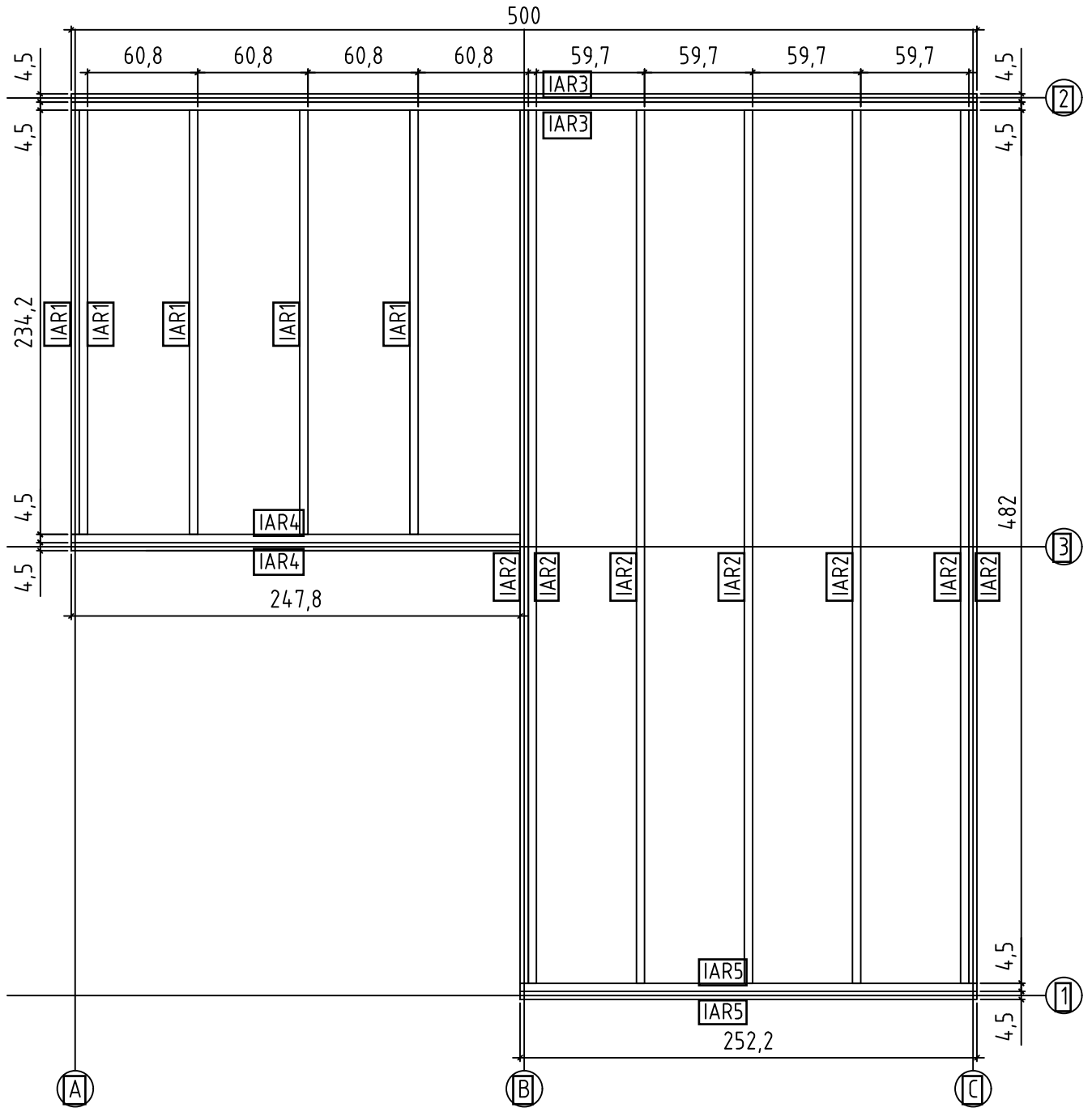

Art. Nr. 4424919

Floor boards - Fussbodenbretter - Plan pose plancher - Pavimento
- Vloerhout - Põrandataudis

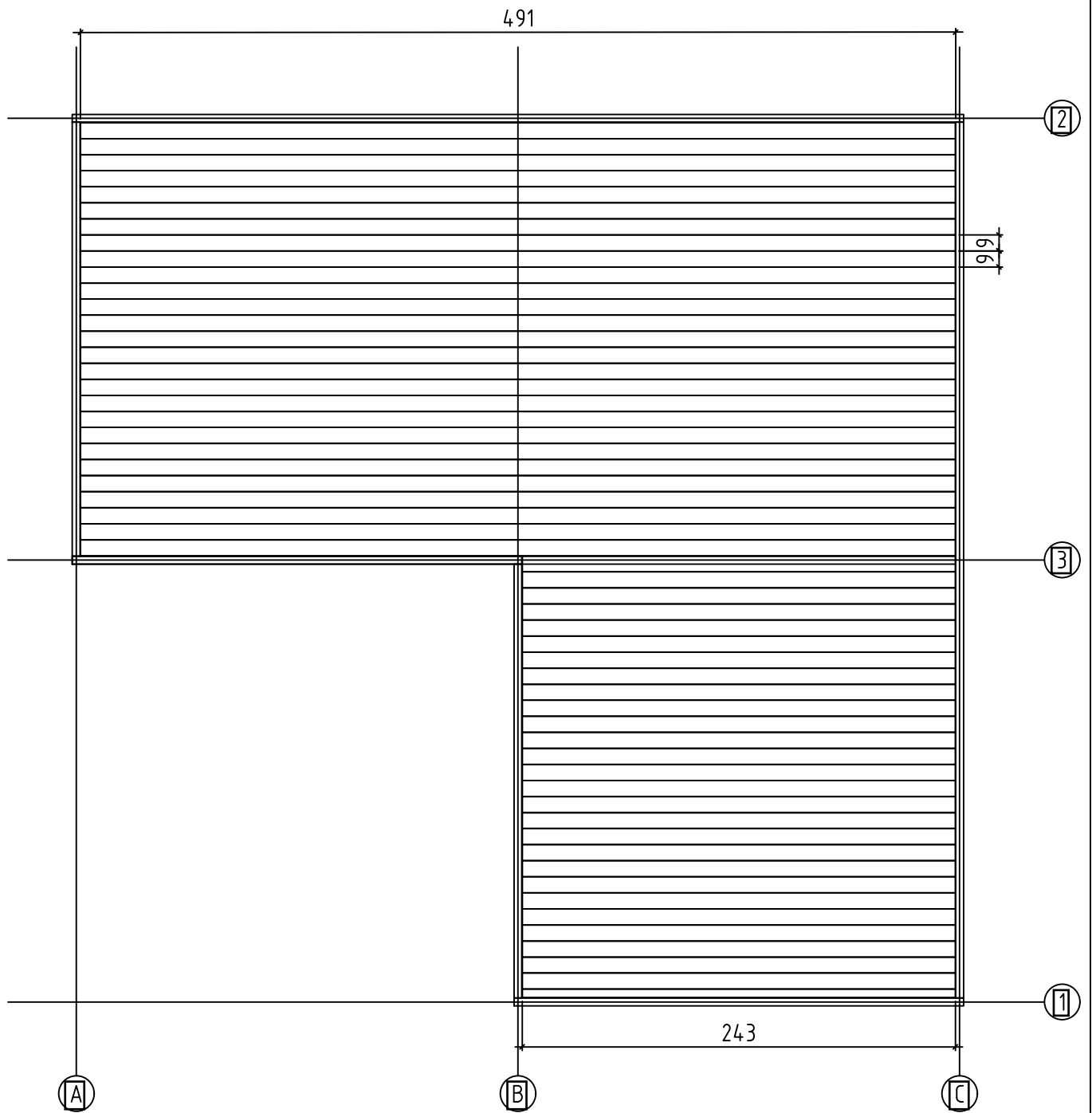

12.03.2020

4/27

Without tongue - Ohne feder - Madrier de finition -
Finate in legno - Zonder veer - Punnita

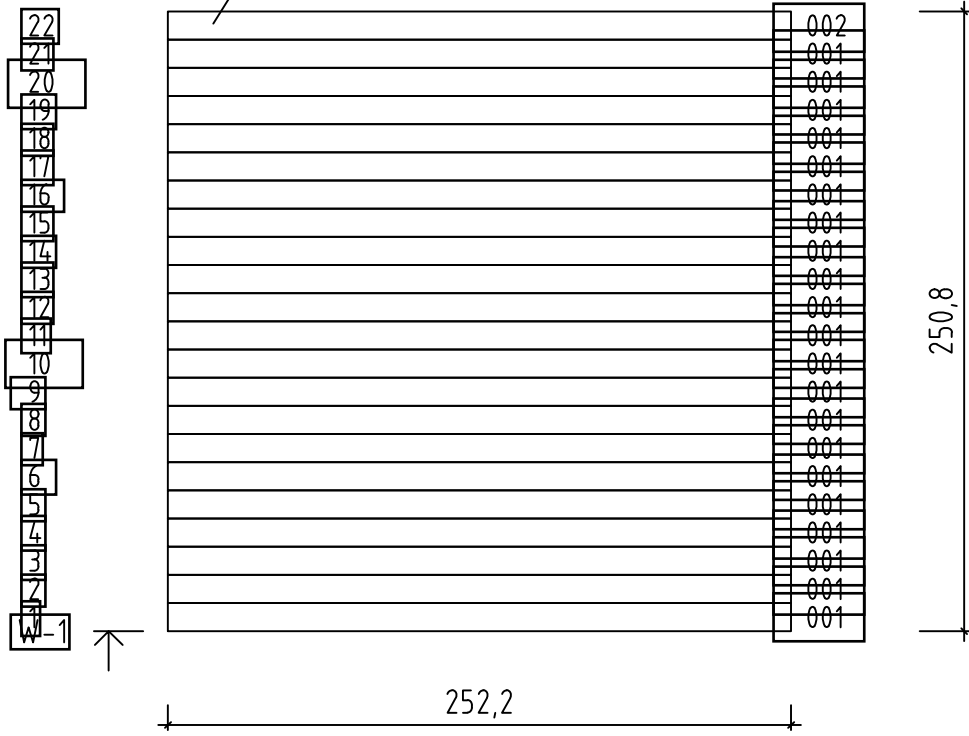



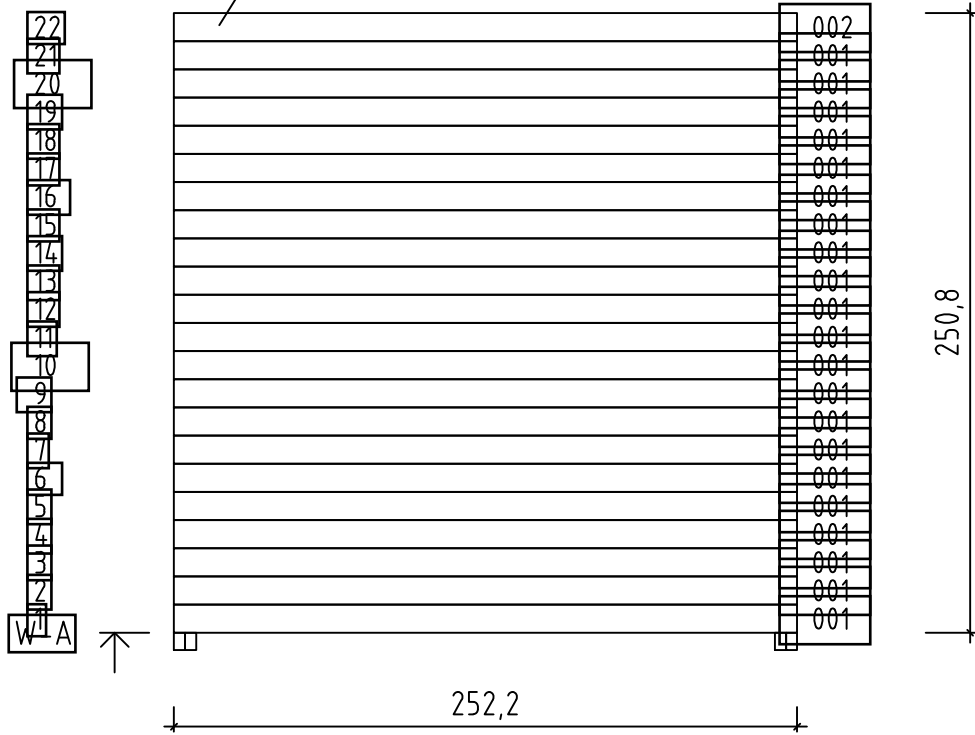

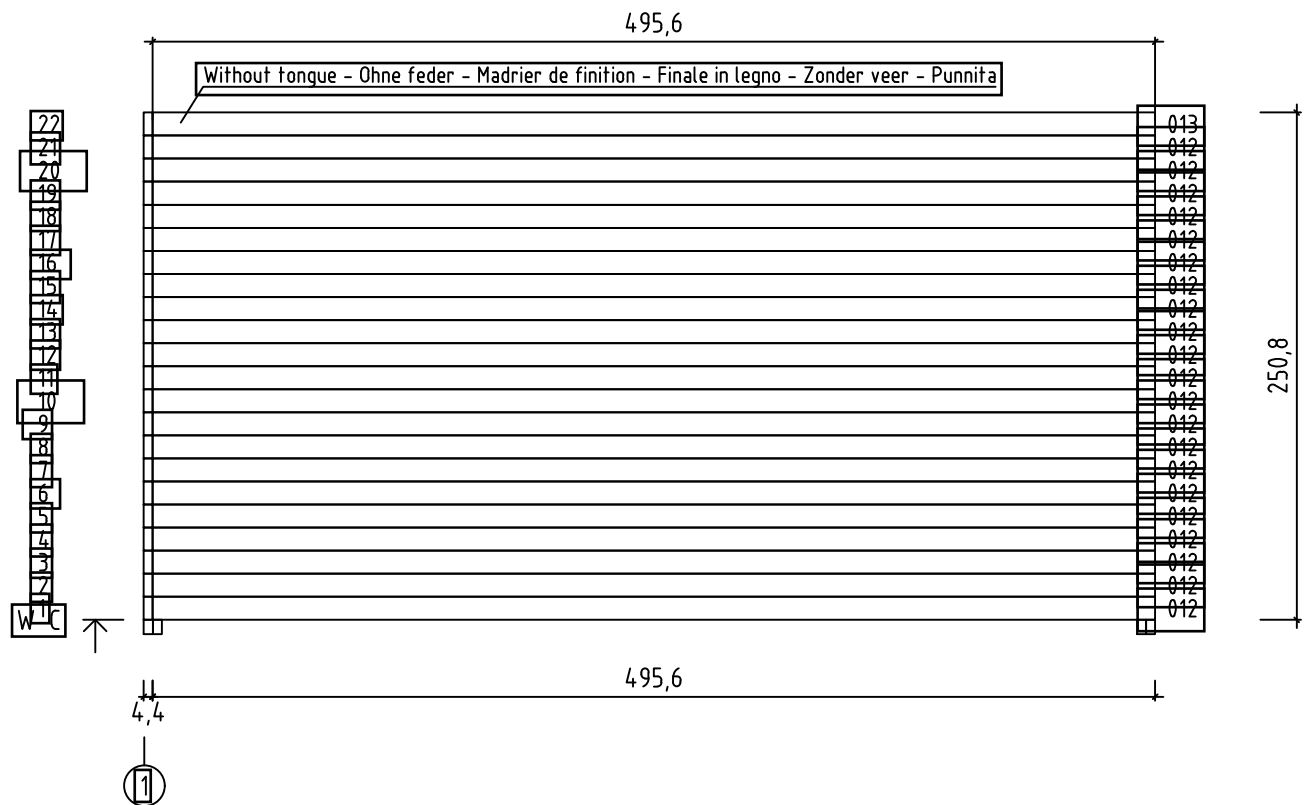
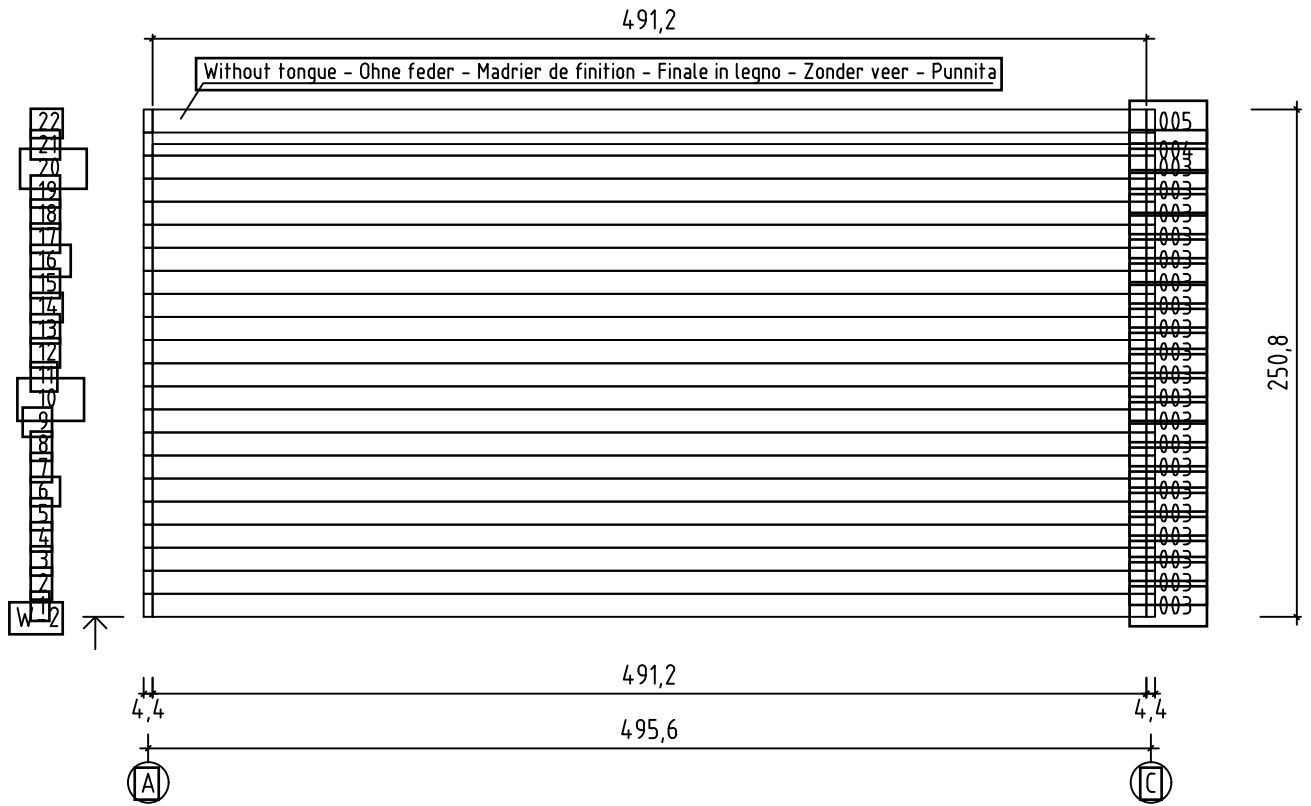

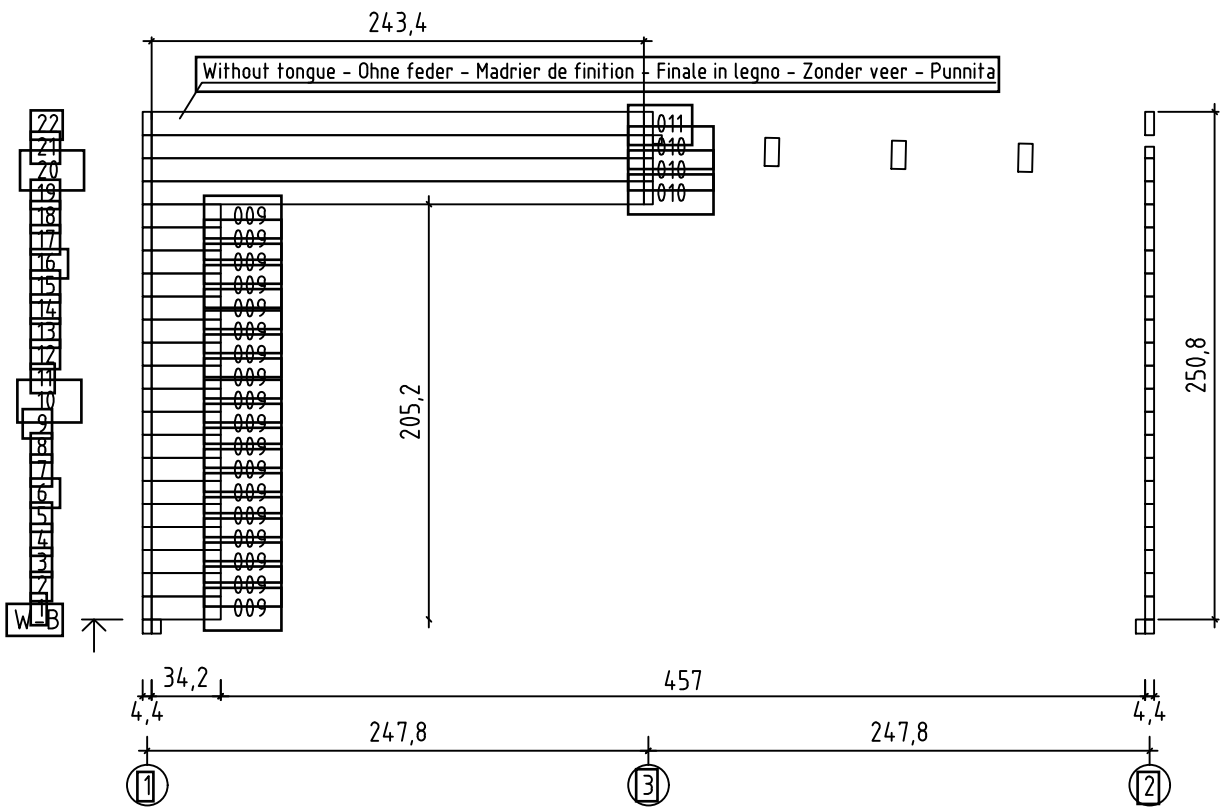
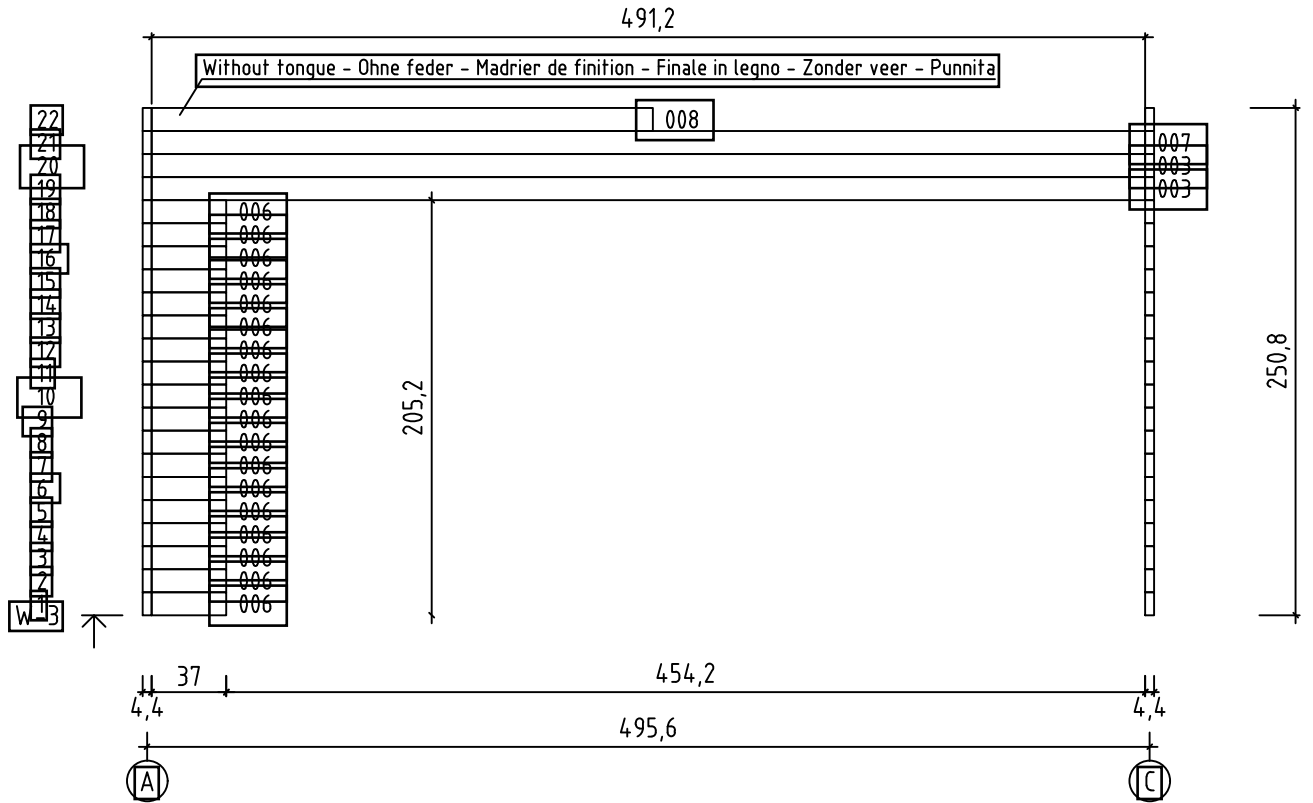

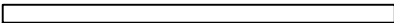

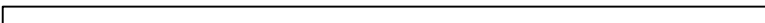
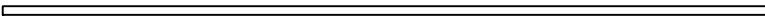



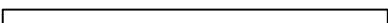

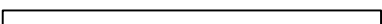

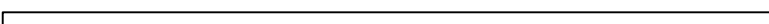
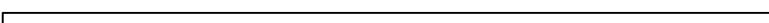
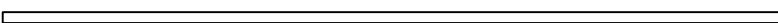

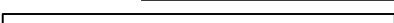
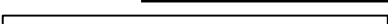
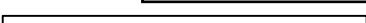
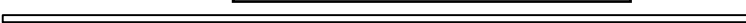

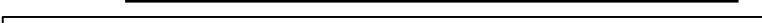
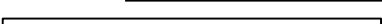















Without tongue - Ohne feder - Madrier de finition -
Finate in legno - Zonder veer - Punnita















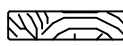
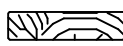
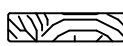
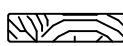
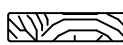
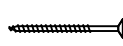
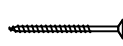







Pos	12.03.2020	Piece list - Stückliste - Liste des pièces - Elementi - Stuklijst - Tükítabel Art. Nr. 4424919	8/27	Q	P (mm)	L (mm)
001				42	44x114	2522
002				2	44x114	2522
003				22	44x114	4912
004				1	44x57	4912
005				1	44x114	4912
006				18	44x114	370
007				1	44x114	4912
008				1	44x114	2478
009				18	44x114	342
010				3	44x114	2434
011				1	44x114	2434
012				21	44x114	4956
013				1	44x114	4956
IAR3		Foundation - Fundament - Fondation - Fondamenta - Fundering - Immutatud alusraam 		2	45x70	5000
IAR2		Foundation - Fundament - Fondation - Fondamenta - Fundering - Immutatud alusraam 		7	45x70	4820
IAR5		Foundation - Fundament - Fondation - Fondamenta - Fundering - Immutatud alusraam 		2	45x70	2522
IAR4		Foundation - Fundament - Fondation - Fondamenta - Fundering - Immutatud alusraam 		2	45x70	2478
IAR1		Foundation - Fundament - Fondation - Fondamenta - Fundering - Immutatud alusraam 		5	45x70	2342
RV1		Lath - Pfetten - Liteau - Piccola asse - Gordingen - Roov 		1	44x44	4798
RV2		Lath - Pfetten - Liteau - Piccola asse - Gordingen - Roov 		1	44x44	2294
A-PR1		Roof beam - Dachbalken - Panne de toit - Perlina del tetto - Gordingen / dakbalk - Pärilin 		3	70x140	4904
A-PR2		Roof beam - Dachbalken - Panne de toit - Perlina del tetto - Gordingen / dakbalk - Pärilin 		3	70x140	2426
FB1		Floor boards - Fussbodenbretter - Lame de plancher - Pavimento - Vloerhout - Pürandataud 		27	90x18	4908

Pos	12.03.2020	Piece list - Stückliste - Liste des pièces - Elementi - Stuklijst - Tükitalabel Art. Nr. 4424919	9/27	Q	P (mm)	L (mm)
FB2	Floor boards - Fussbodenbretter - Lame de plancher - Pavimento - Vloerhout - Põrandalaud		28		90x18	2430
DB1	Roof boards - Dachbretter - Voliges - Perlina per tetto - Dakhout - Katuselaud		55+1		90x18	2571
DB2	Roof boards - Dachbretter - Voliges - Perlina per tetto - Dakhout - Katuselaud		28+1		90x18	2479
	Floor fillet - Fussbodenteiste - Corniere de finition du plancher - Finitura per pavimento (battisco pa) - Vloer afwerktijst - Põrandatiist				18x18	20
DPL1	Roofing felt fillet - Dachpappenleiste - Baquette de fixation du feutre bitumeux - Asse per fissaggio guaina bituminosa - Afdektijst asfaltpapier - Katusepapitiist		1		18x58	2420
DPL2	Roofing felt fillet - Dachpappenleiste - Baquette de fixation du feutre bitumeux - Asse per fissaggio guaina bituminosa - Afdektijst asfaltpapier - Katusepapitiist		1		18x58	2536
DPL3	Roofing felt fillet - Dachpappenleiste - Baquette de fixation du feutre bitumeux - Asse per fissaggio guaina bituminosa - Afdektijst asfaltpapier - Katusepapitiist		1		18x58	2594
DPL4	Roofing felt fillet - Dachpappenleiste - Baquette de fixation du feutre bitumeux - Asse per fissaggio guaina bituminosa - Afdektijst asfaltpapier - Katusepapitiist		2		18x58	2602
DPL5	Roofing felt fillet - Dachpappenleiste - Baquette de fixation du feutre bitumeux - Asse per fissaggio guaina bituminosa - Afdektijst asfaltpapier - Katusepapitiist		1		18x58	2718
FL1	Fillet - Leiste - Lattes - Massellino di guarnizione per ringhiera - Lijst - Liist		1		28x34	342
RS2	Railing strip - Begrenzungsleiste - Rembarde - Sbarra - Afscheidingslijst - Piirdelaud		2		18x70	1982
RS4	Railing strip - Begrenzungsleiste - Rembarde - Sbarra - Afscheidingslijst - Piirdelaud		2		18x70	2000
RS7	Railing strip - Begrenzungsleiste - Rembarde - Sbarra - Afscheidingslijst - Piirdelaud		2		18x90	2116
RS8	Railing strip - Begrenzungsleiste - Rembarde - Sbarra - Afscheidingslijst - Piirdelaud		2		18x90	2126
P1	Post - Pfosten - Poteau - Piede registrabile - Stijl - Post		2		70x70	2337
P2	Post - Pfosten - Poteau - Piede registrabile - Stijl - Post		1		70x70	2394
P3	Post - Pfosten - Poteau - Piede registrabile - Stijl - Post		2		70x70	2452
P4	Post - Pfosten - Poteau - Piede registrabile - Stijl - Post		1		90x90	2052
DRV1	Roof edge reinforcement - Dachrandverstärkung - Corniere de renfort de bord de toit - Rinforzo x tetto - Dakrand versterking - Räästafugevdus		1		80x44	2398
DRV2	Roof edge reinforcement - Dachrandverstärkung - Corniere de renfort de bord de toit - Rinforzo x tetto - Dakrand versterking - Räästafugevdus		2		80x44	2478
DRV3	Roof edge reinforcement - Dachrandverstärkung - Corniere de renfort de bord de toit - Rinforzo x tetto - Dakrand versterking - Räästafugevdus		1		80x44	2558
DRV4	Roof edge reinforcement - Dachrandverstärkung - Corniere de renfort de bord de toit - Rinforzo x tetto - Dakrand versterking - Räästafugevdus		4		80x44	2602
FF2	Fixing fillet - Fixierungsleiste - Profil de fixation - Massello di fissaggio - Bevestiging tijstwerk - Tendertiist		2		15x45	2026

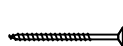
Pos	12.03.2020	Piece list - Stückliste - Liste des pièces - Elementi - Stuklijst - Tükítabel Art. Nr. 4424919	10/27	Q	P (mm)	L (mm)
FF		Fixing fillet - Fixierungsleiste - Profil de fixation - Massello di fissaggio - Bevestiging lijstwerk - Tenderliist		2	18x44	2030
FF3		Fixing fillet - Fixierungsleiste - Profil de fixation - Massello di fissaggio - Bevestiging lijstwerk - Tenderliist		2	38x46	1980
FF4		Fixing fillet - Fixierungsleiste - Profil de fixation - Massello di fissaggio - Bevestiging lijstwerk - Tenderliist		2	38x46	2026
FL2		Fillet - Leiste - Lattes - Massellino di guarnizione per ringhiera - Lijst - Liist		2	44x44	330
GL1		Gable moulding - Giebelleiste - Planche de rive - Finitura per frontale e retro del tetto - Gevettijst - Viitutaud		2	18x120	2478
GL2		Gable moulding - Giebelleiste - Planche de rive - Finitura per frontale e retro del tetto - Gevettijst - Viitutaud		2	18x120	2580
GL3		Gable moulding - Giebelleiste - Planche de rive - Finitura per frontale e retro del tetto - Gevettijst - Viitutaud		2	18x120	2598
GL4		Gable moulding - Giebelleiste - Planche de rive - Finitura per frontale e retro del tetto - Gevettijst - Viitutaud		1	18x120	2682
GL5		Gable moulding - Giebelleiste - Planche de rive - Finitura per frontale e retro del tetto - Gevettijst - Viitutaud		1	18x120	2718
HS32		Screw for door jamb - Schraube für türrahmen - Vis de fixation partie haute avec montants du cadre de porte - Viti x fissaggio montanti porte - Schroef voor deurkozijn - Kruvi ukse tengite		8	4x25	
HS14		Screw for wall details - Schraube für wand details - Vis pour mur details - Viti per elementi della porta - Schroef voor wand details - Kruvi seinetontaažiks		460	4.5x80	
HS12		Screw for doorstep - Schrauben für swelle - Vis pour fixation barre de seuil - Vite per soglia della porta - Schroef voor deurdorpel - Kruvi lävepakute		6	4x40	
HS12		Screw for metal corner - Holzschraube für metallwinkel - Vis de fixation des cornieres en métal - Viti per fissare suadretta di metallo di giunzione - Schroef voor metalen hoek - Kruvi nurgikute		20	4x40	
HS12		Screw for covering moulding - Schrauben für deckungsprofil - Vis de fixation profils horizontaux haut intérieur et extérieur d'encadrement de porte - Vite per cornice di copertura - Schroef voor afdekprofiel - Kruvi piirdetauute		32	4x40	
HS12		Screw for beam holder - Schrauben für balkenhalter - Vis de fixation support "u" galvanisé - Vite per trave di sostegno - Schroef voor bevestiging bathouder (gordingschoen) - Kruvi talakingate		144	4x40	
HS12		Screw for fixing fillet of door and window - Schrauben für fixierungsleiste - Vis pour profil vertical de fixation pour ouvertures des fenetres et portes - Viti per massello di fissaggio - Schroeven voor bevestiging van deur en raam lijsten - Kruvi tenderliistudele		36	4x40	
HS12		Screw for door jamb - Schraube für türrahmen - Vis de fixation partie haute avec montants du cadre de porte - Viti x fissaggio montanti porte - Schroef voor deurkozijn - Kruvi ukse tengite		12	4x40	
HS12		Screw for gable moulding - Schrauben für giebelleiste - Vis pour fixation planche de rive - Vite per fissare finitura davanti e dietro del tetto - Schroef voor gevettijst - Kruvi viitutaute		48	4x40	
HS13		Screw for wall details - Schraube für wand details - Vis pour mur details - Viti per elementi della porta - Schroef voor wand details - Kruvi seinadetaiite		36	4x60	
HS33		Screw for door jamb - Schraube für türrahmen - Vis de fixation partie haute avec montants du cadre de porte - Viti x fissaggio montanti porte - Schroef voor deurkozijn - Kruvi ukse tengite		16	5x40	
HS16		Screw for foundation - Schrauben zur befestigung fundament - Vis de fixations des poutrelles de fondations - Viti x fondamenta - Schroef voor fundering - Kruvi alusraamite		44	5x90	
HS16		Screw for post - Schrauben für pfosten - Vis de fixation des poteaux - Viti per inviare - Schroef voor stijlen - Kruvi postite		12	5x90	
HS16		Screw for roof edge reinforcement - Schrauben für dachrandverstärkung - Vis pour fixation corniere renfort de bord de toit - Viti x rinforzo bordo tetto - Schroef voor dakrand versterking - Kruvi räästatugevdusele		40	5x90	

Art. Nr. 4424919

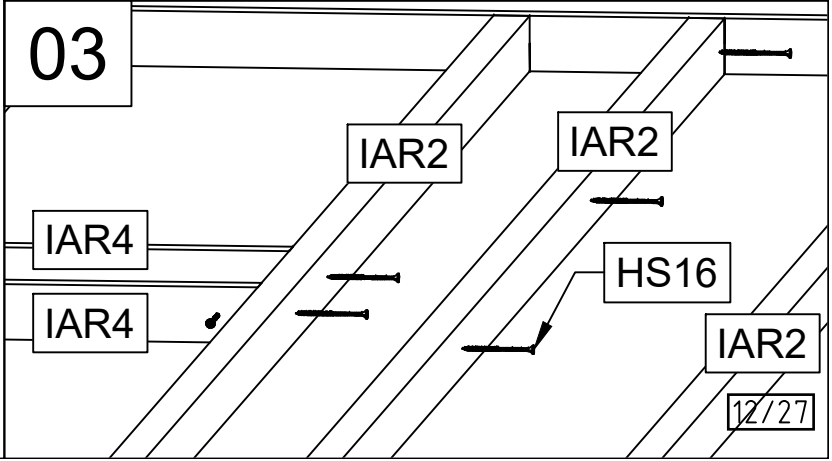
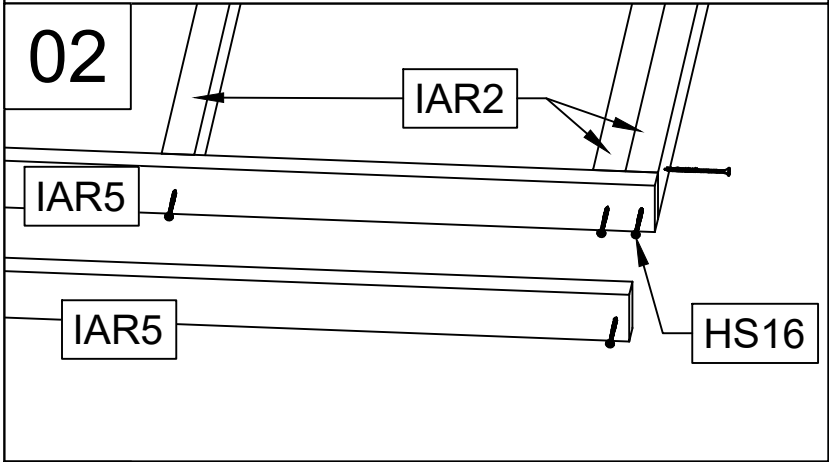
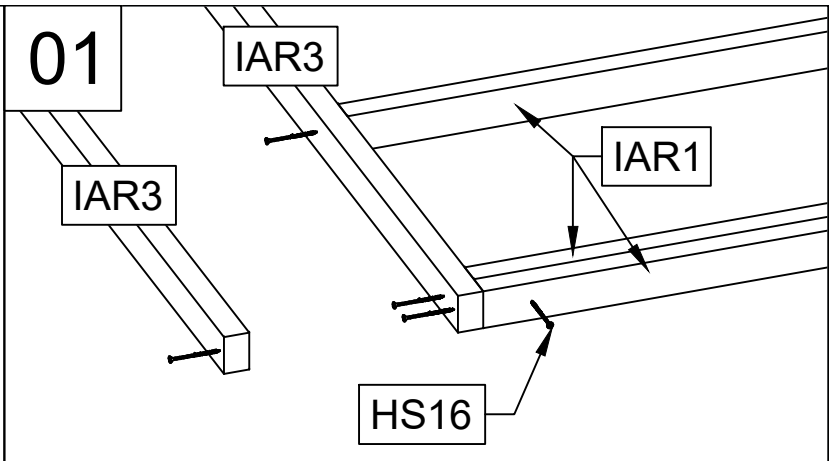
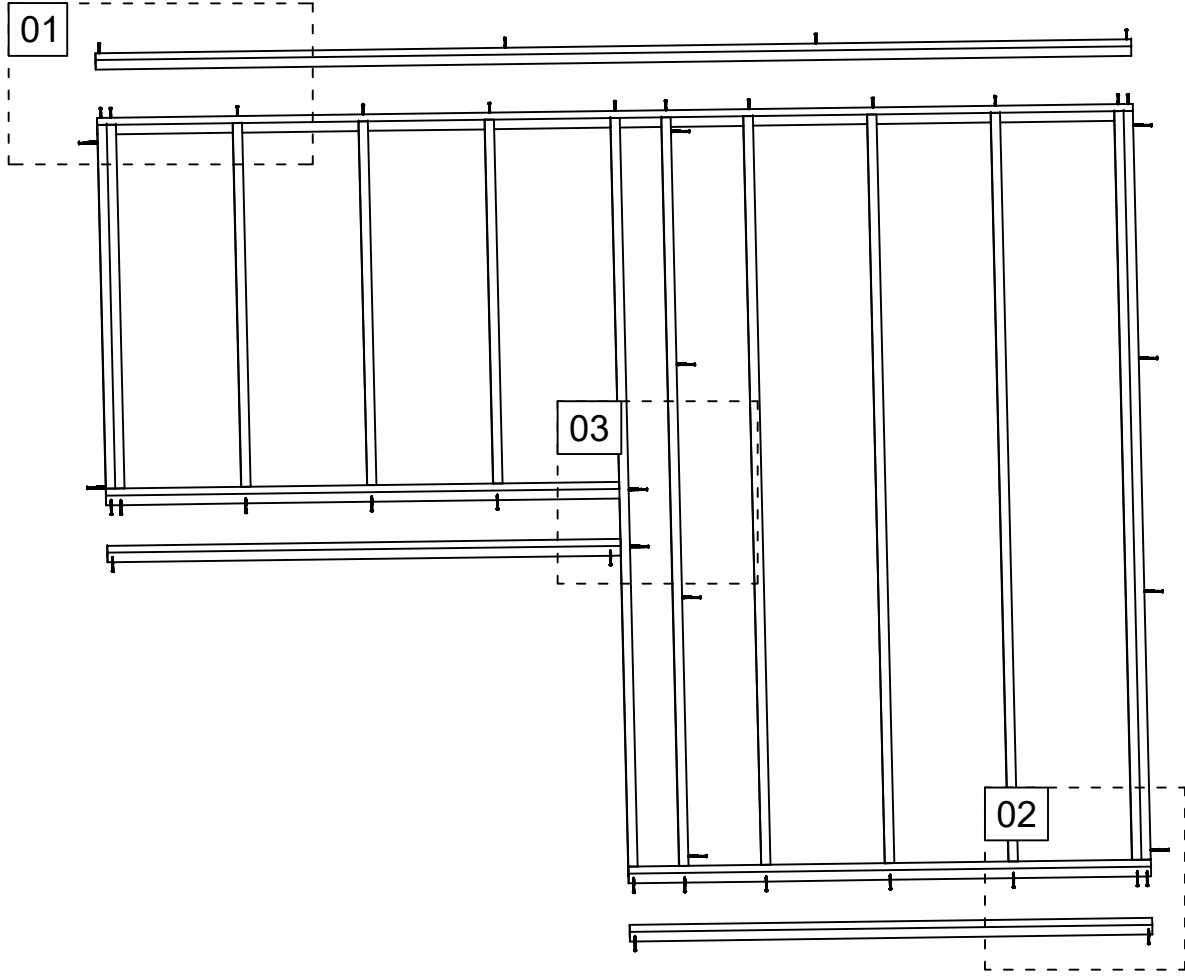

12.03.2020

Art. Nr. 4424919

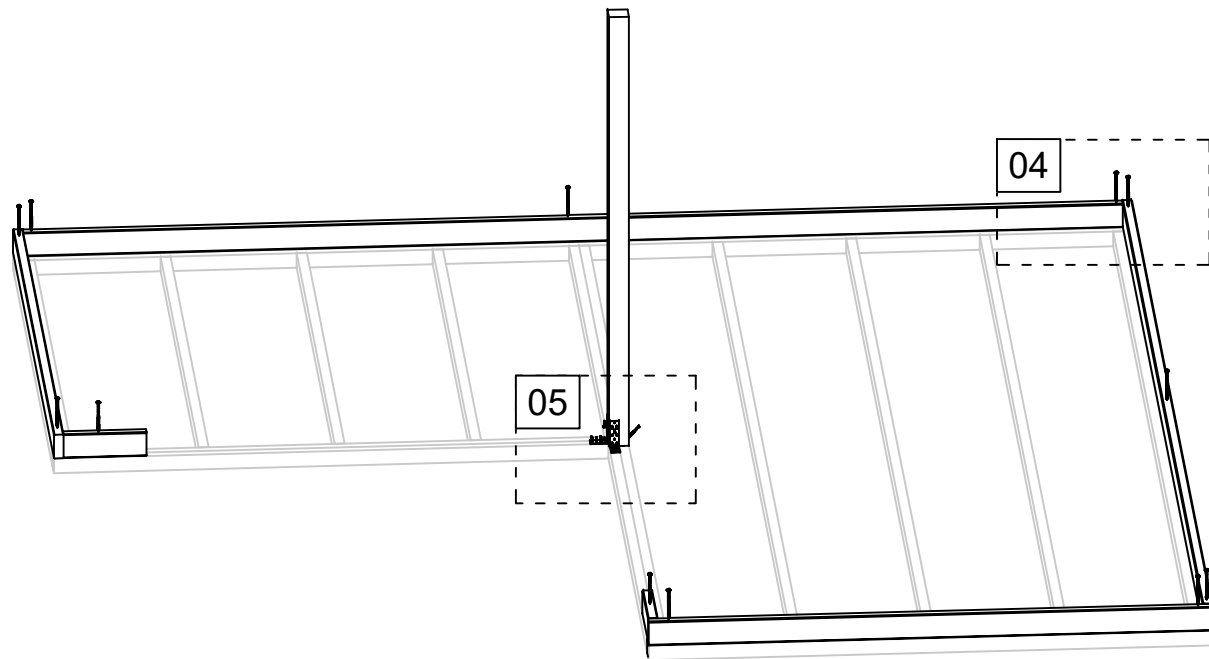

04

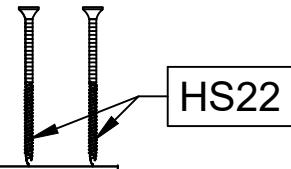

05

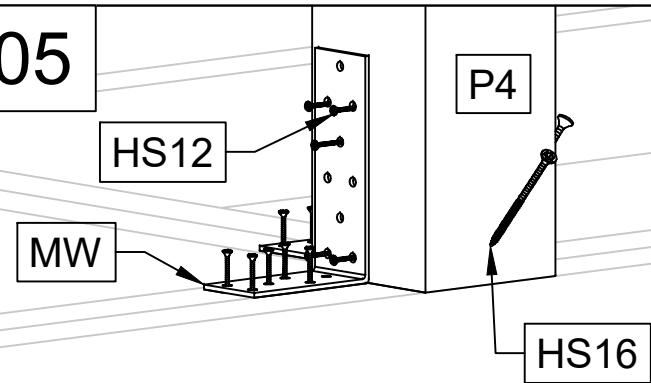

05

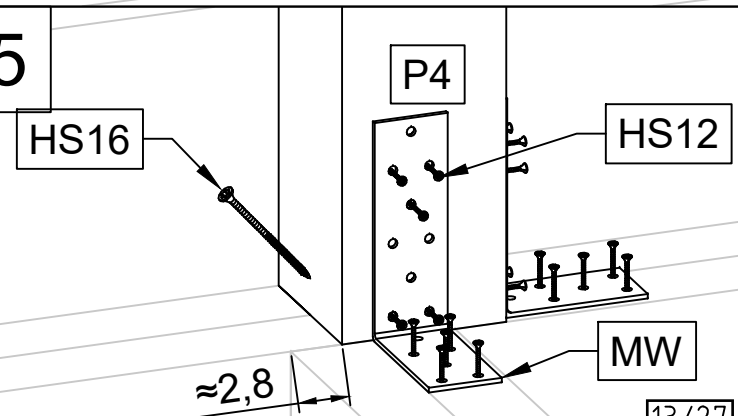

12.03.2020

13/27

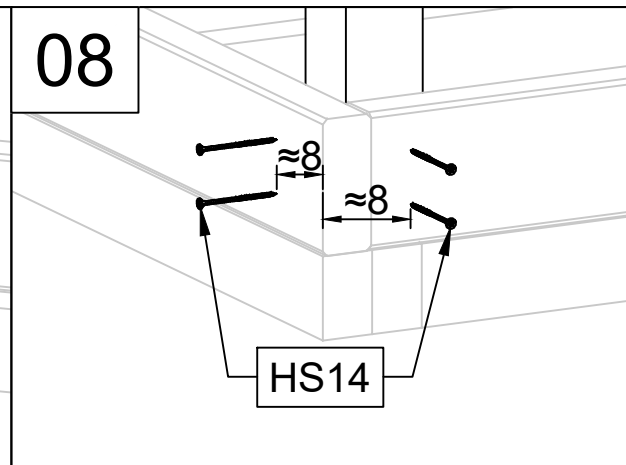
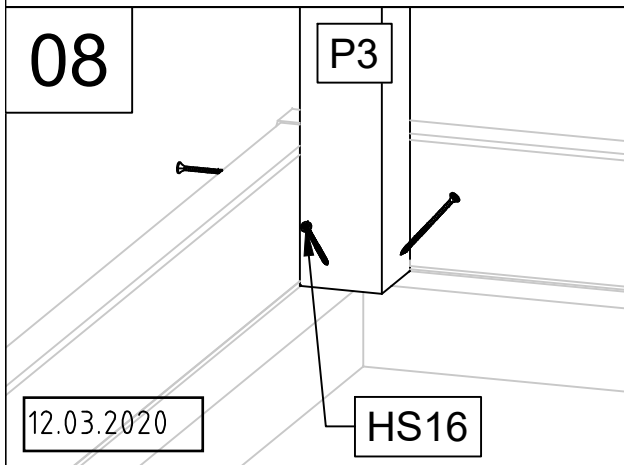
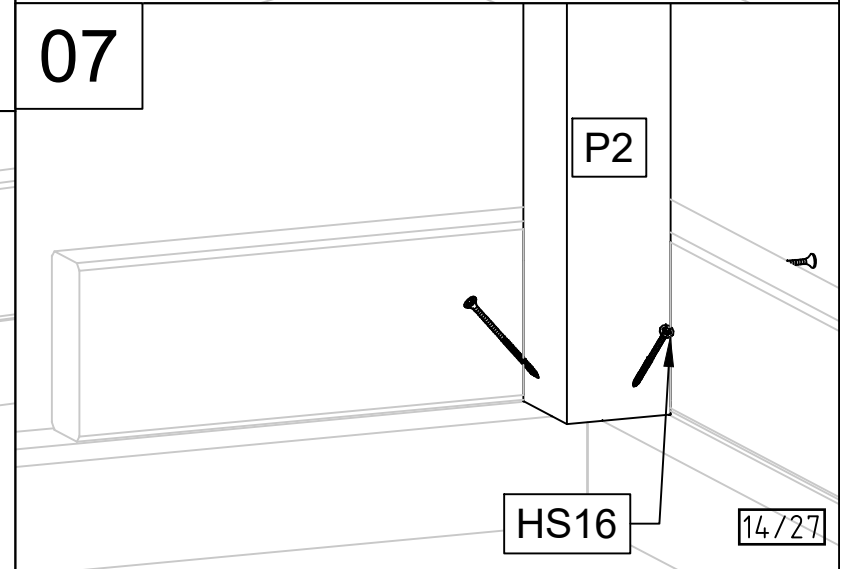
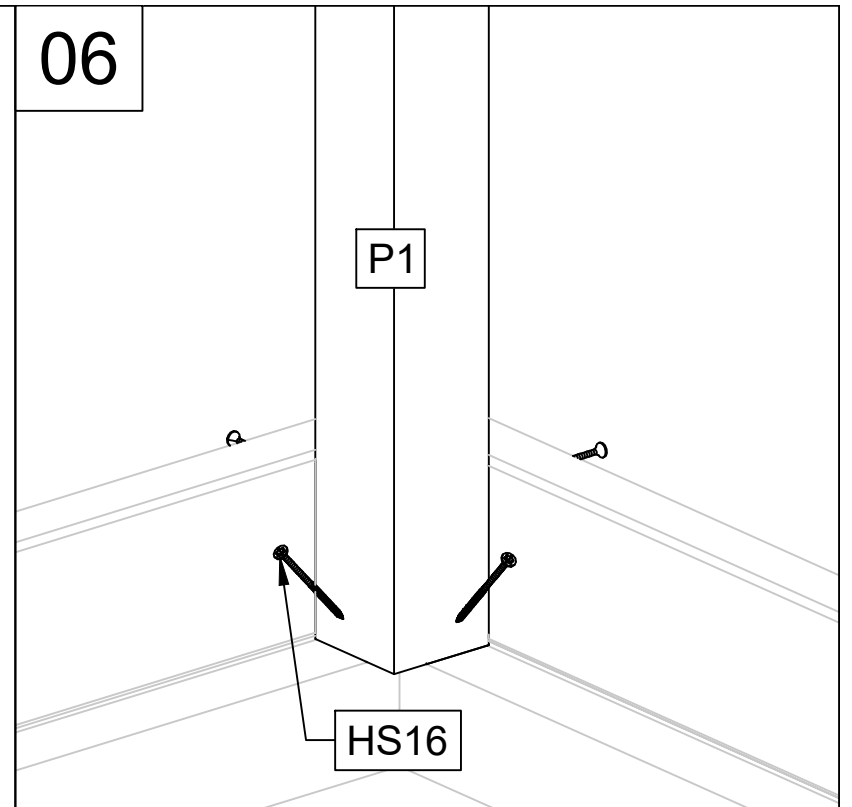
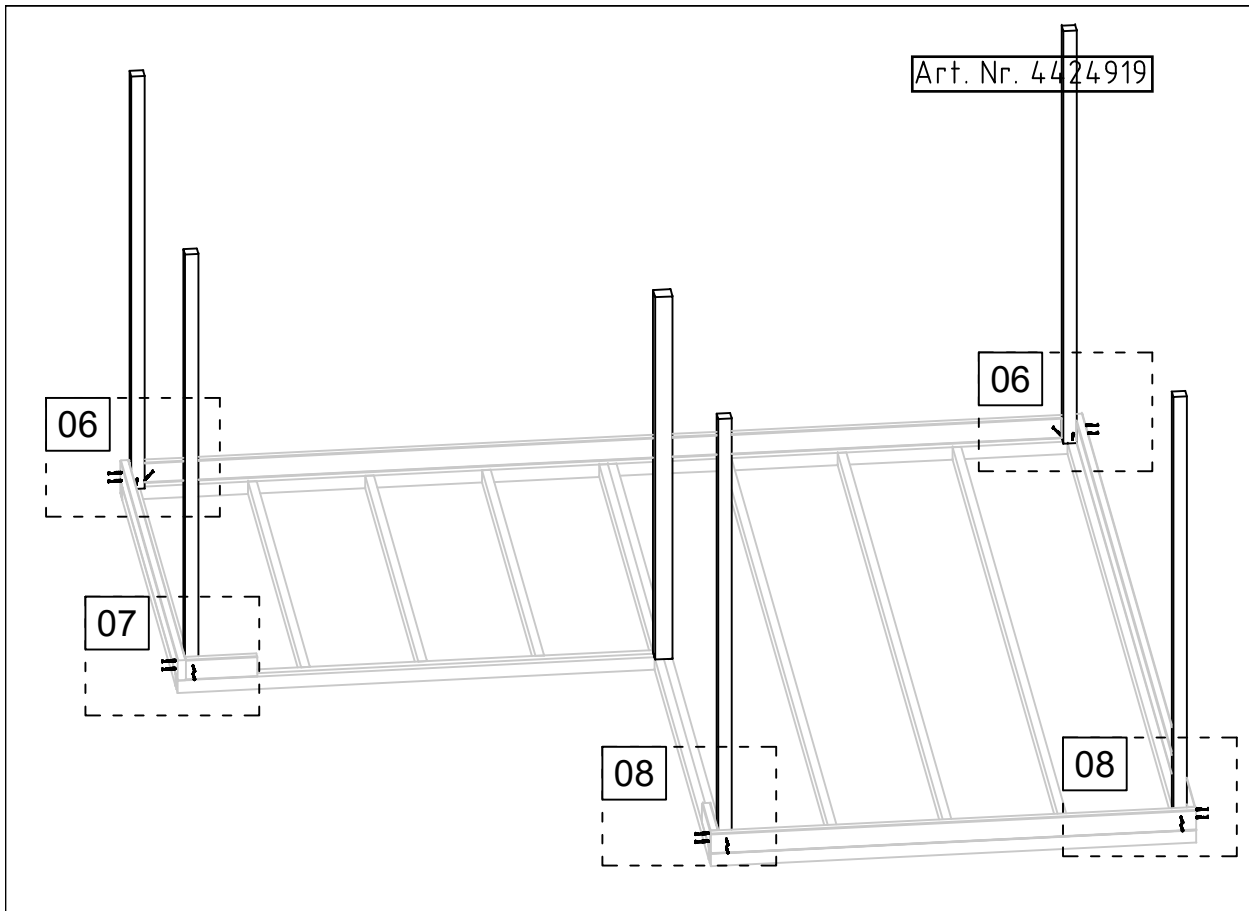

Art. Nr. 4424919

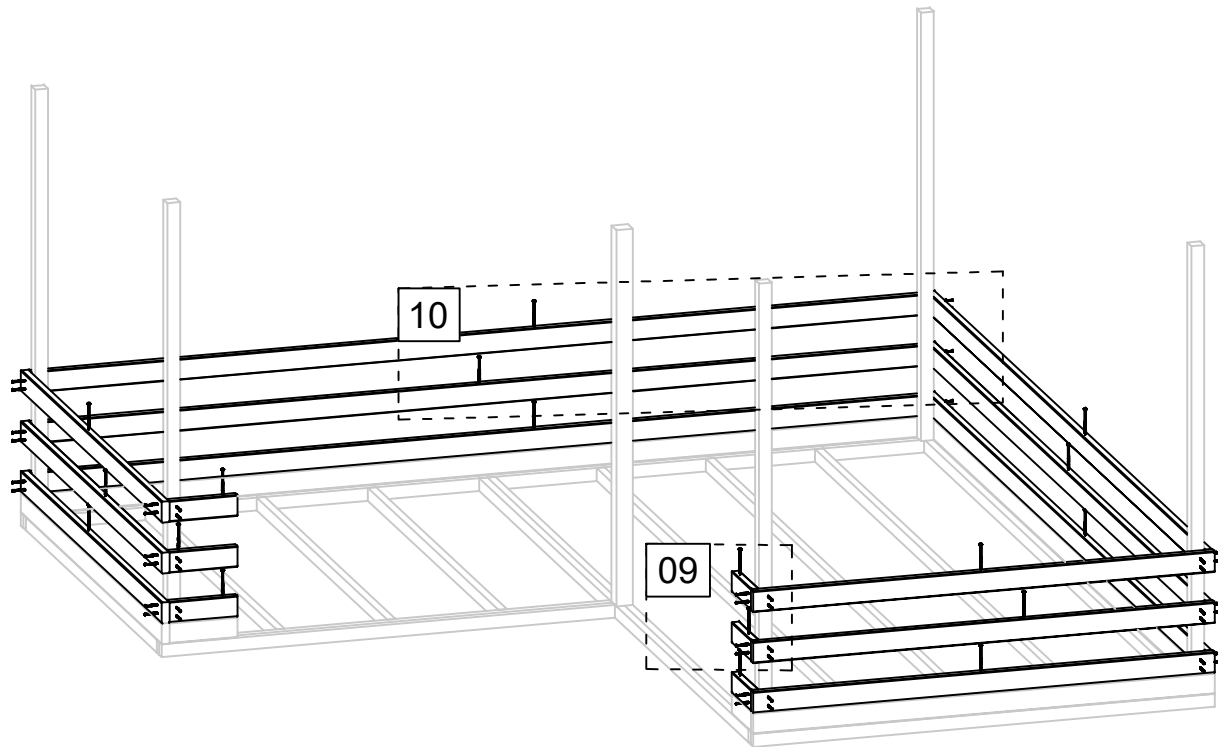

12.03.2020

09

HS23

HS14

10

HS14

HS23

15/27

Art. Nr. 4424919

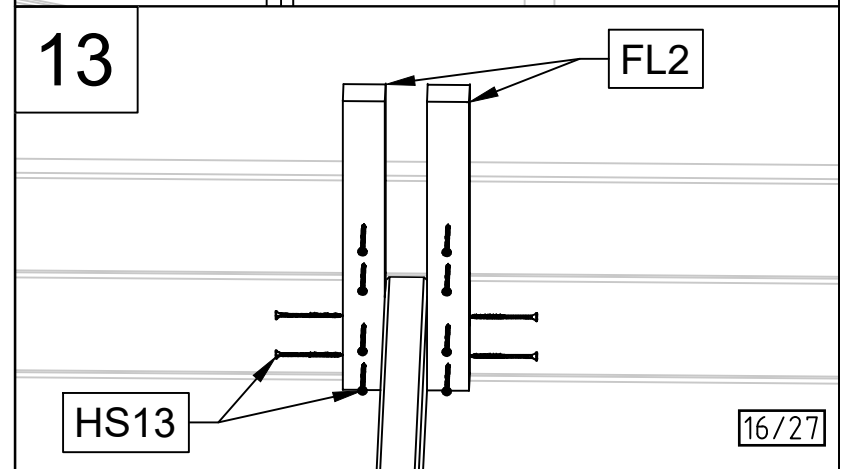
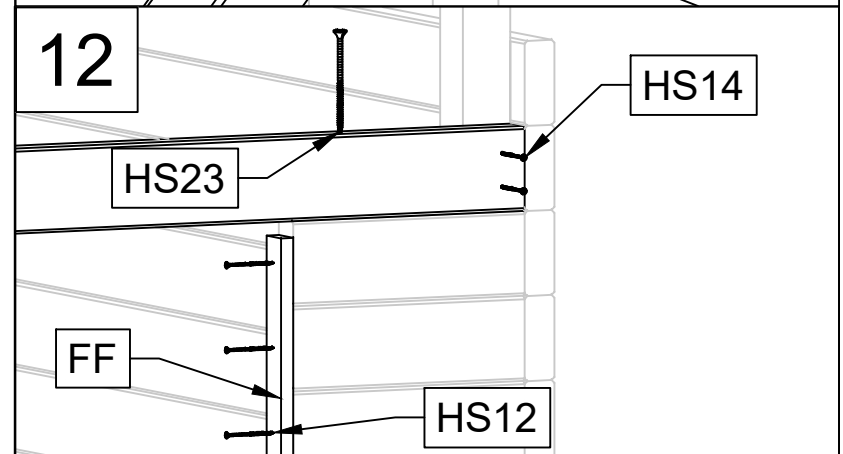
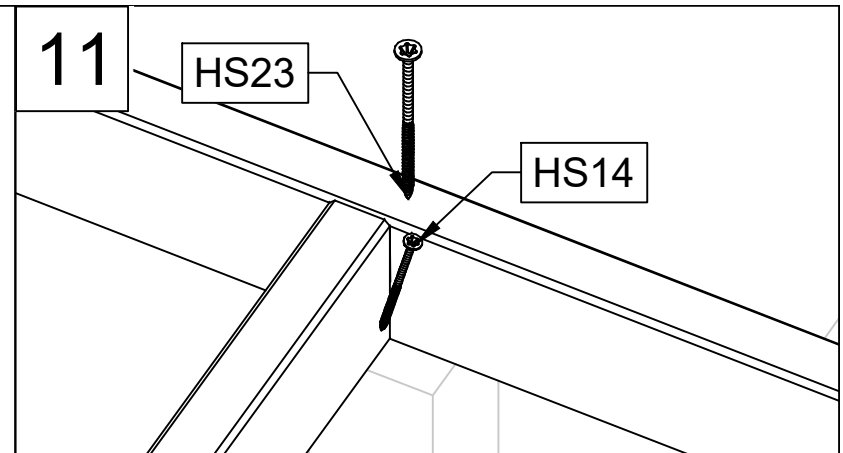
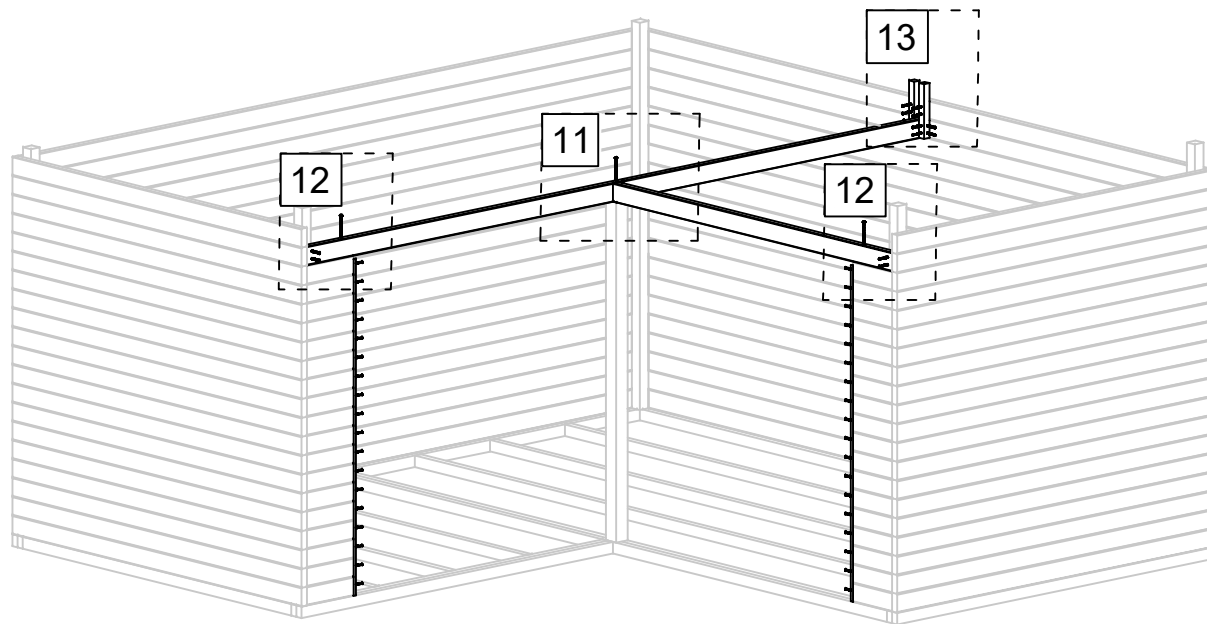

12.03.2020

16/27

Art. Nr. 4424919

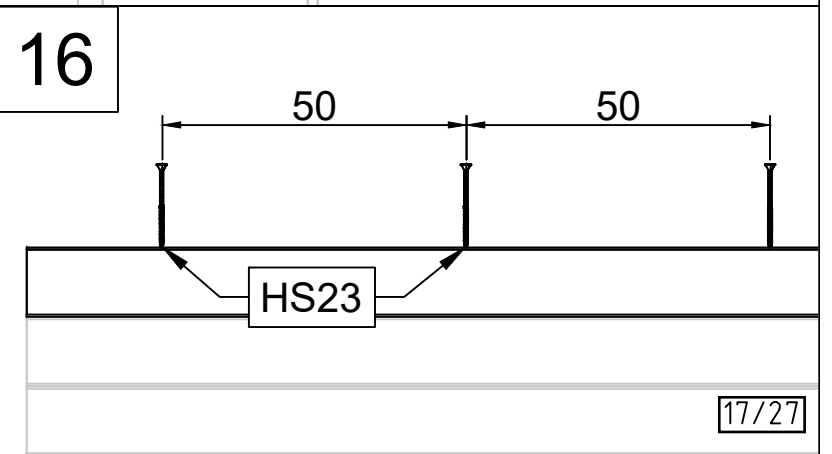
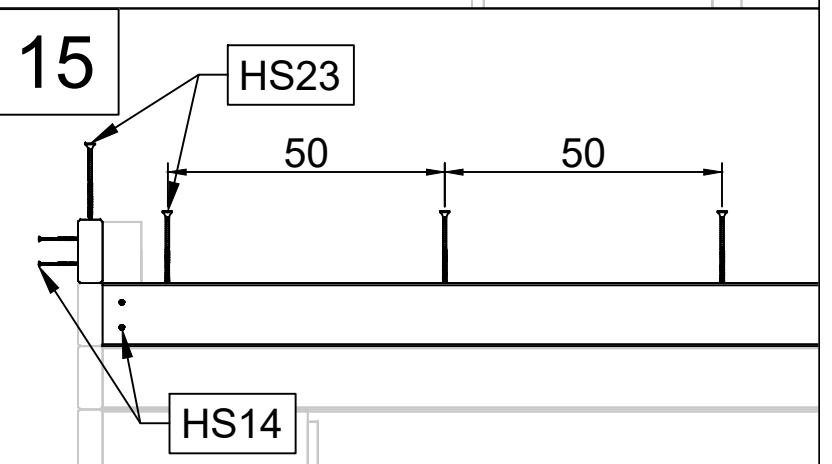
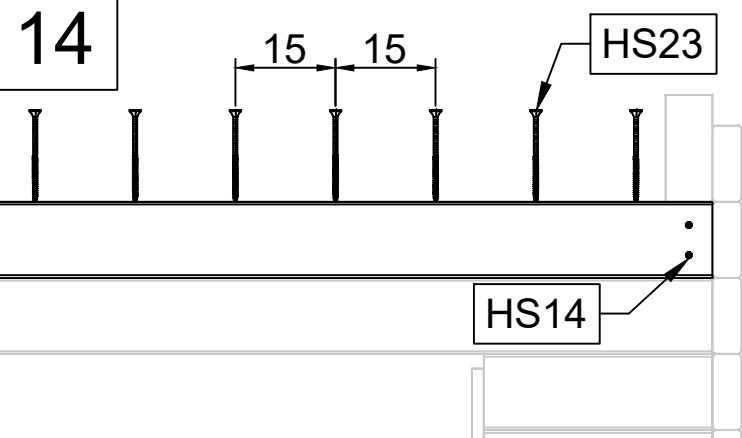
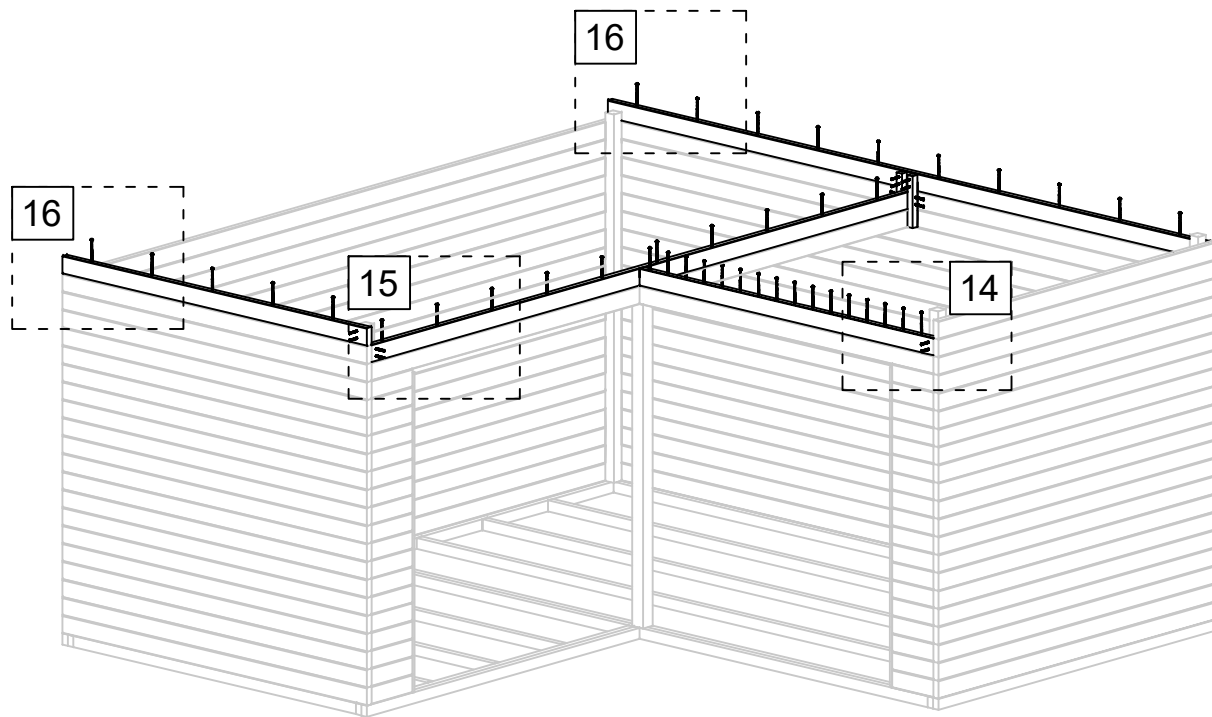

12.03.2020

17/27

Art. Nr. 4424919

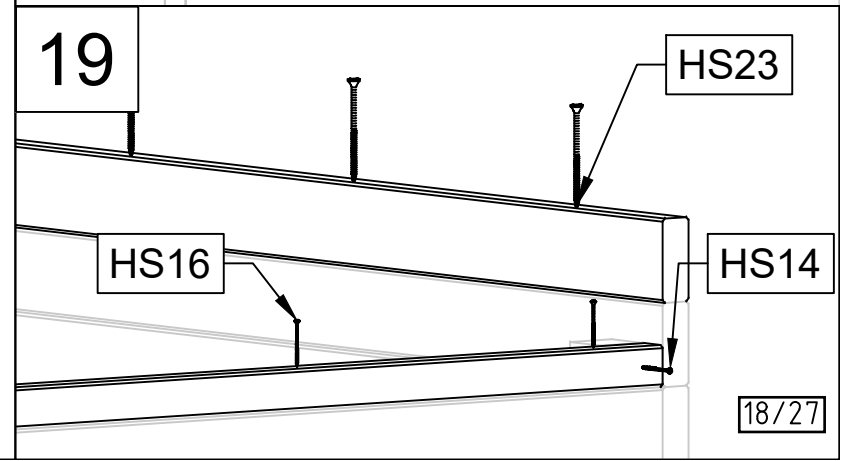
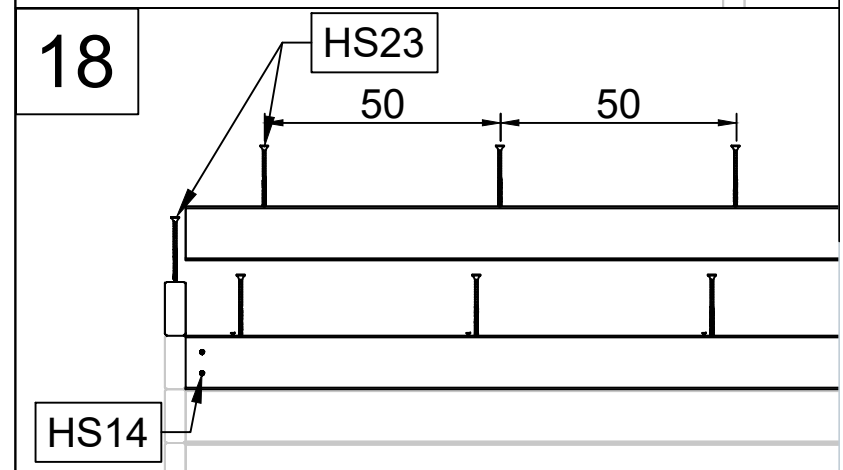
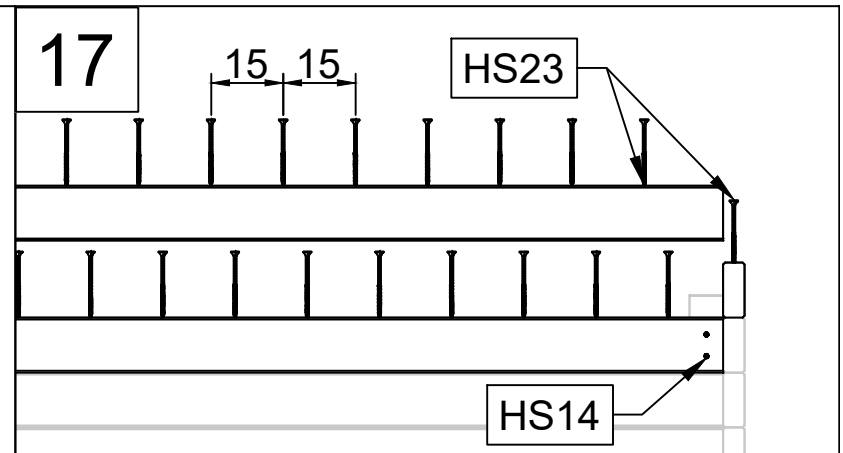
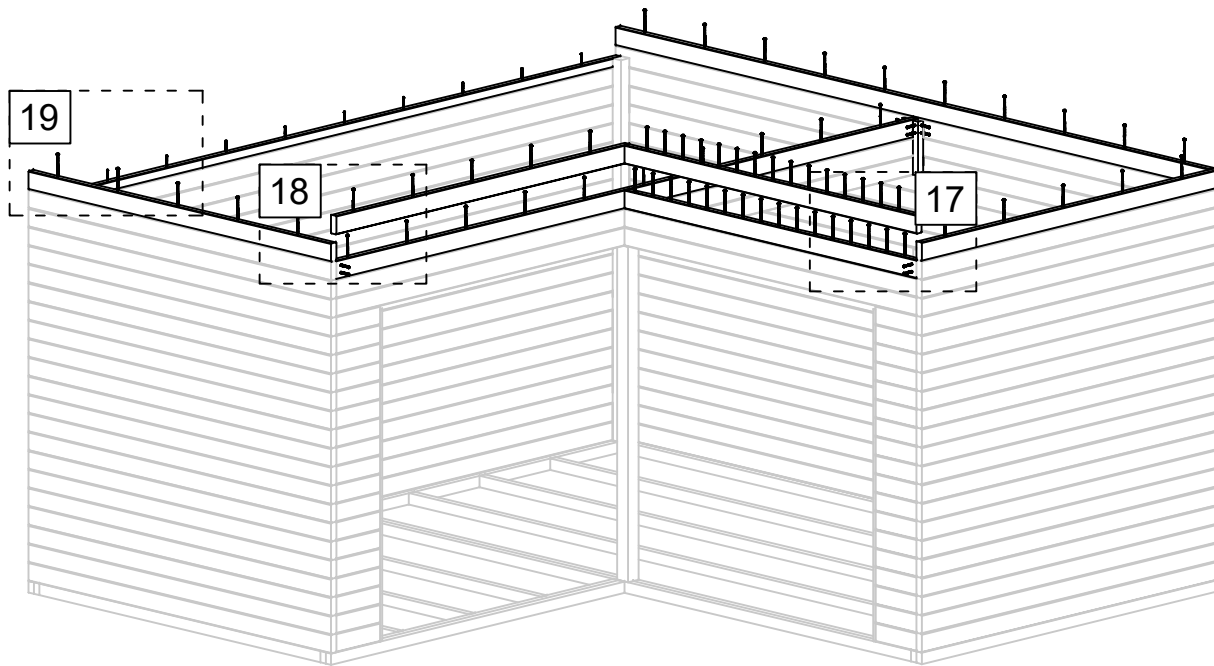

12.03.2020

Art. Nr. 4424919

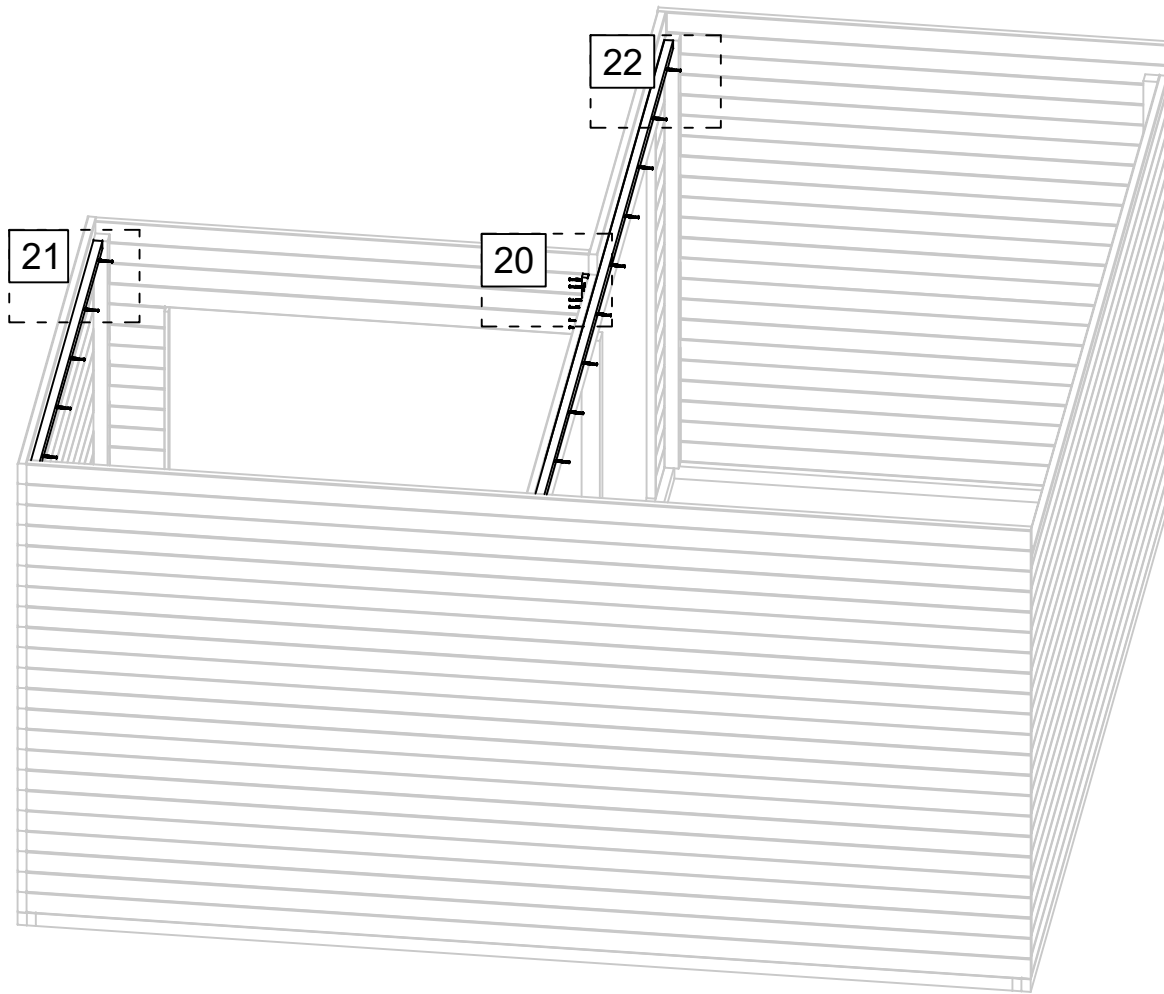

20

HS13

FL1

21

HS14

RV2

22

HS14

RV1

12.03.2020

19/27

Art. Nr. 4424919

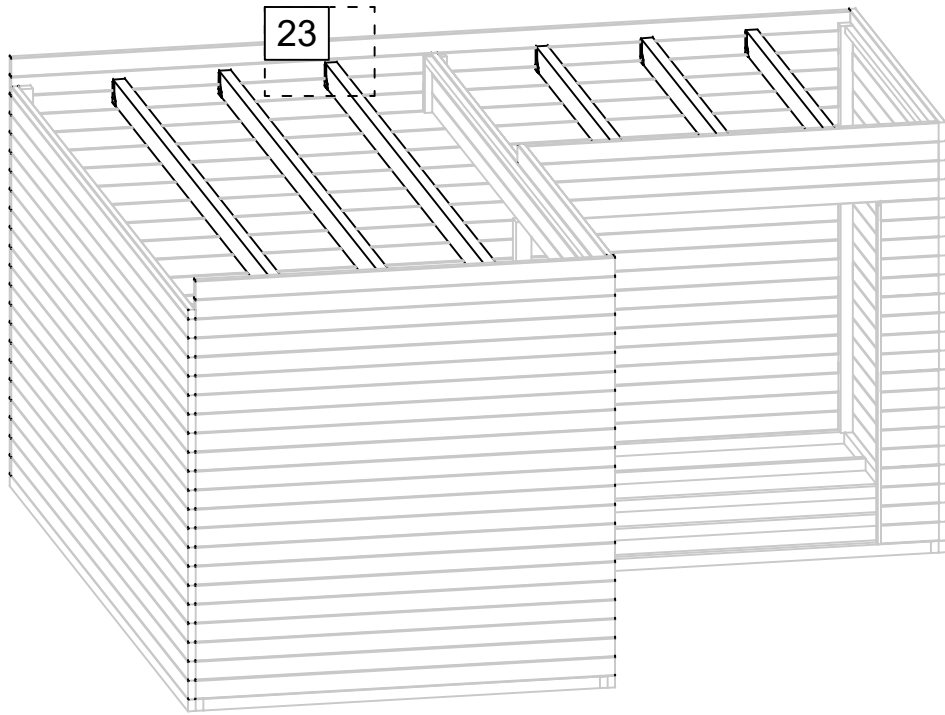

23

≈1,5cm

BM

HS12

HS12

BM

HS12

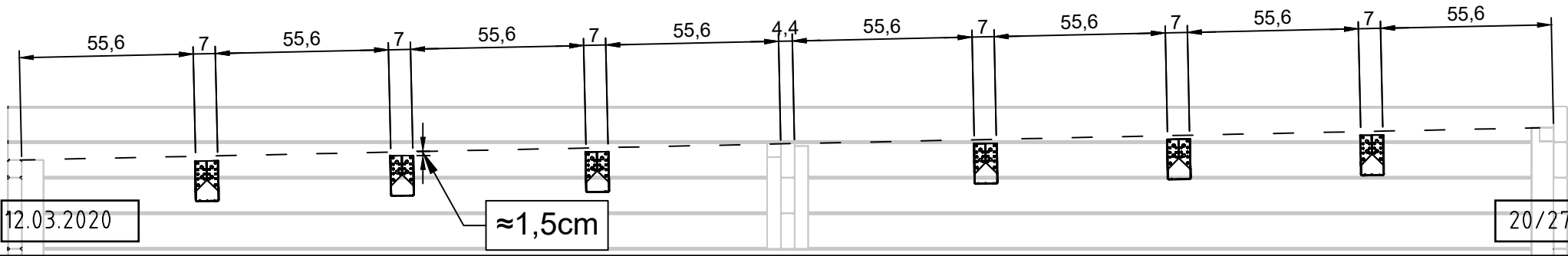

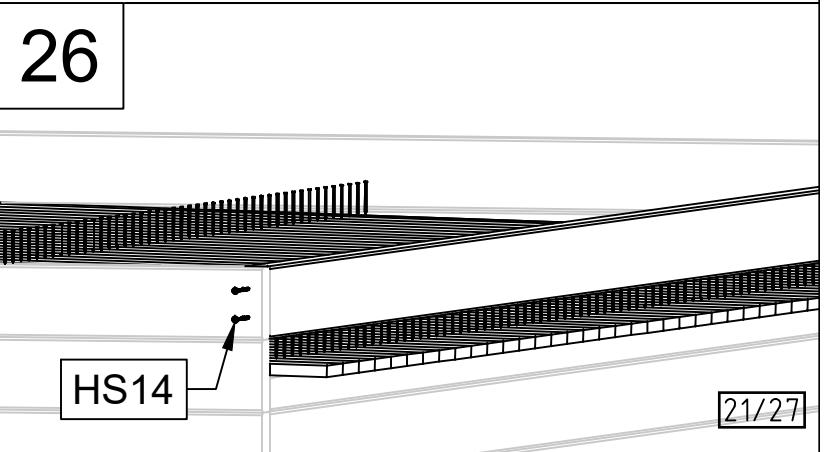
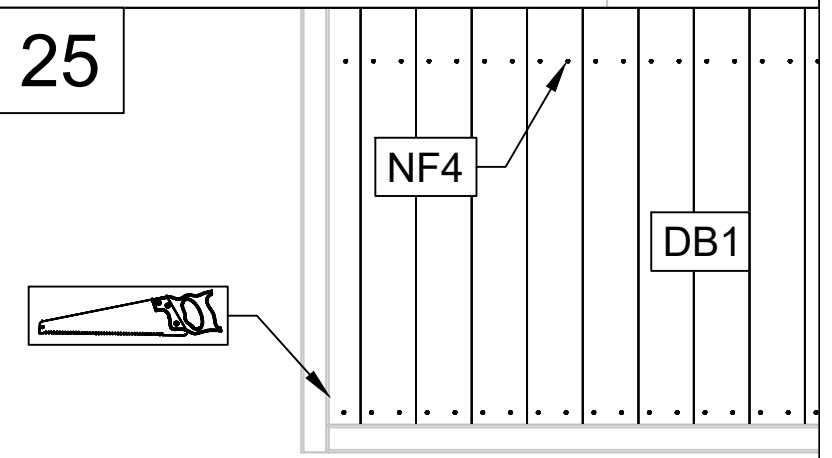
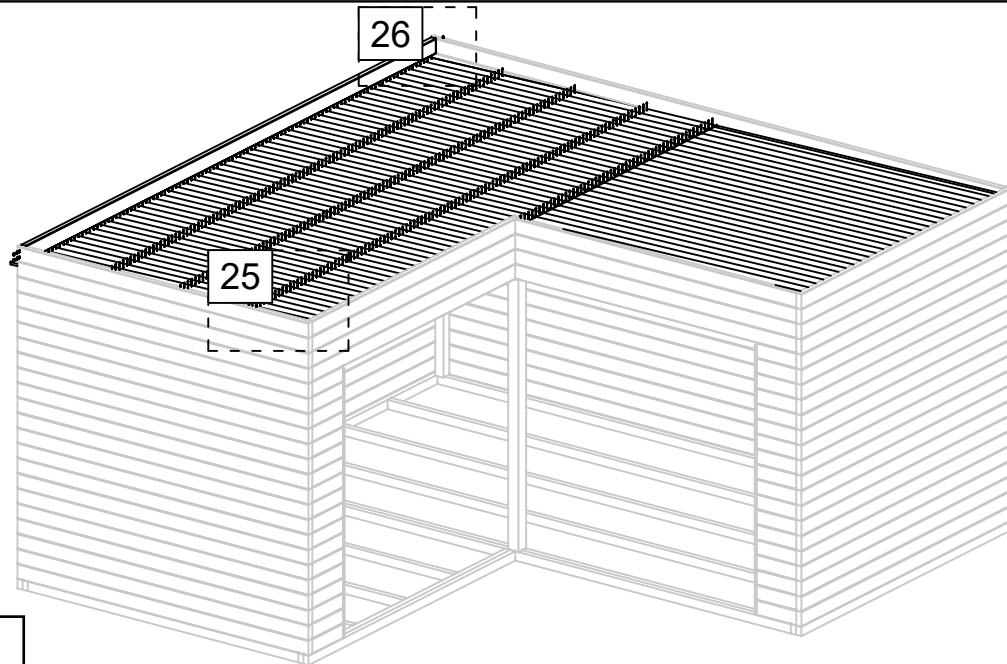
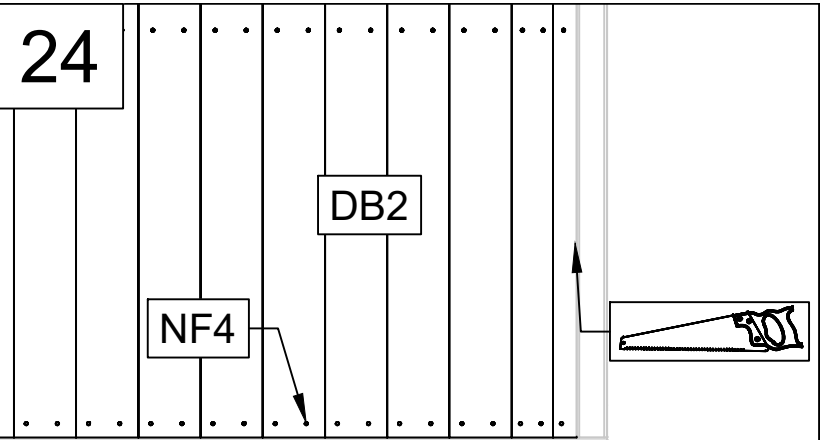
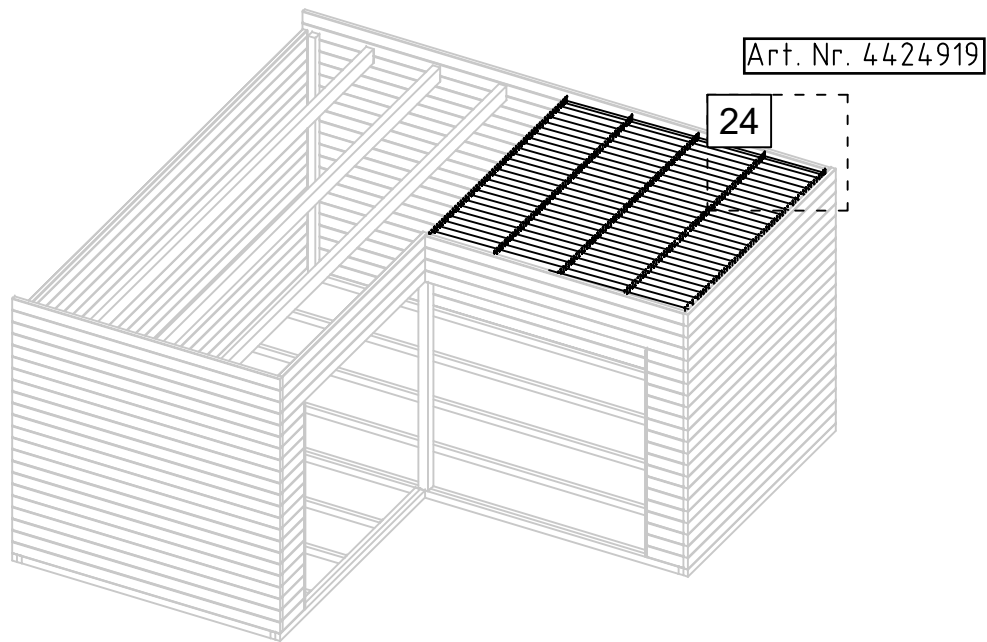

12.03.2020

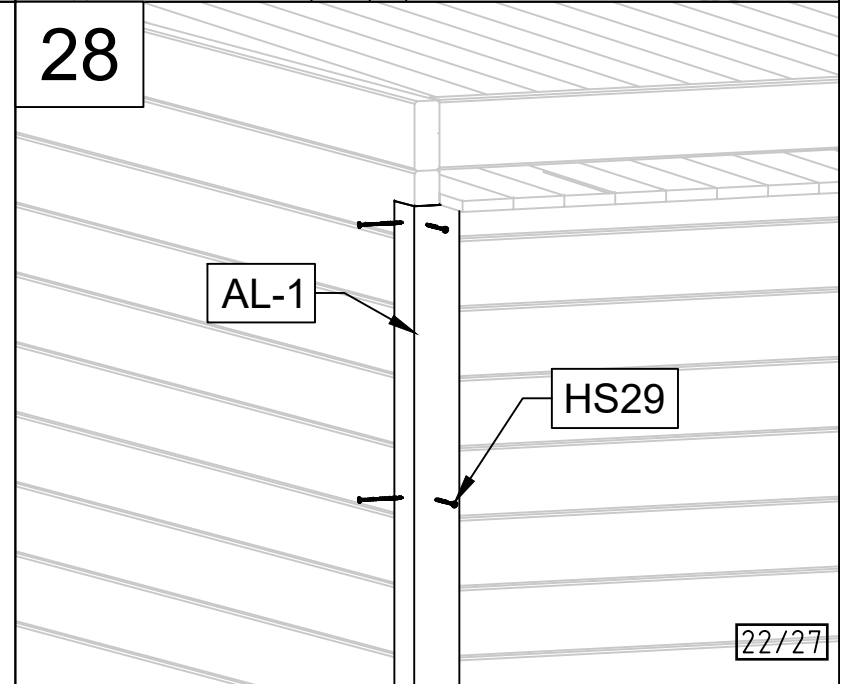
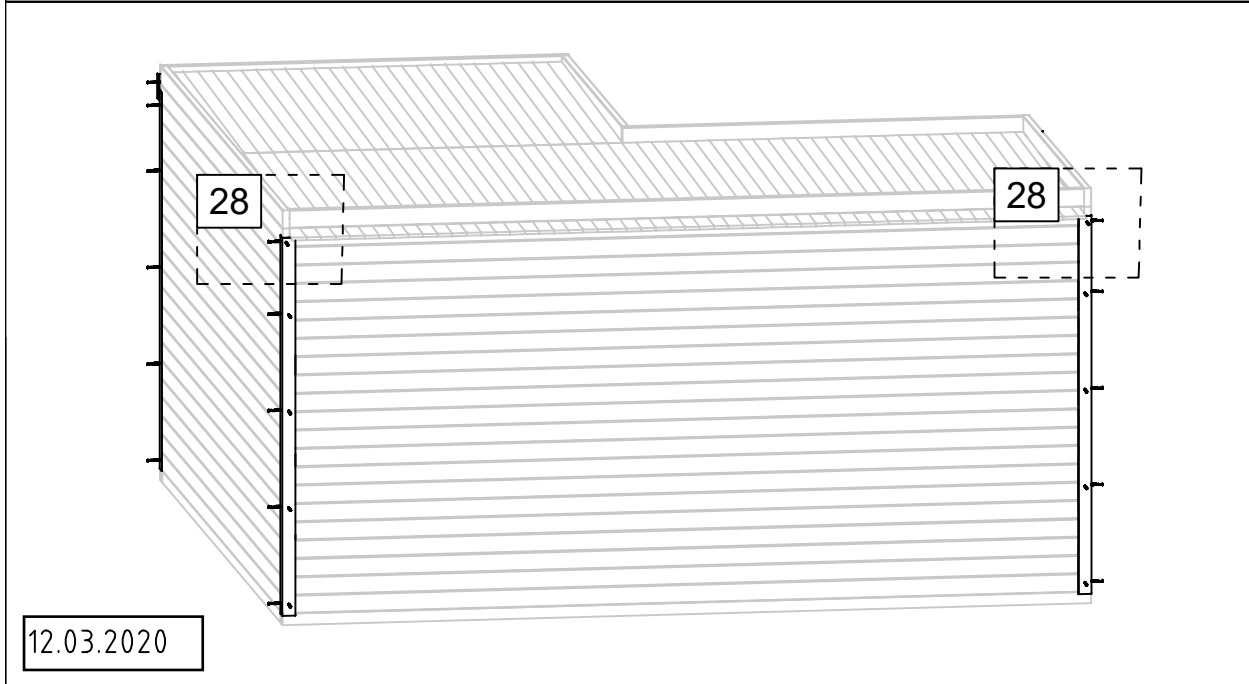
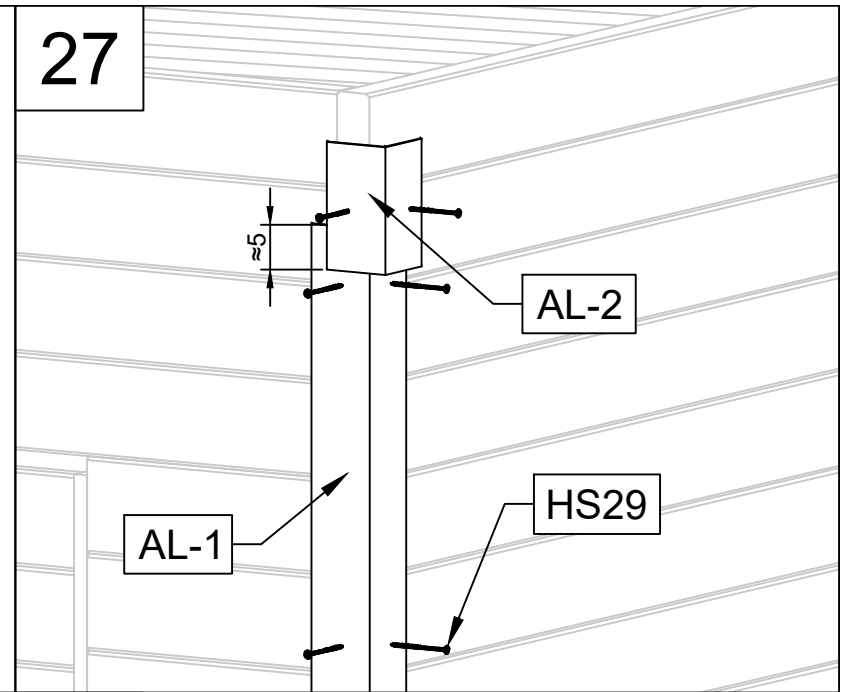
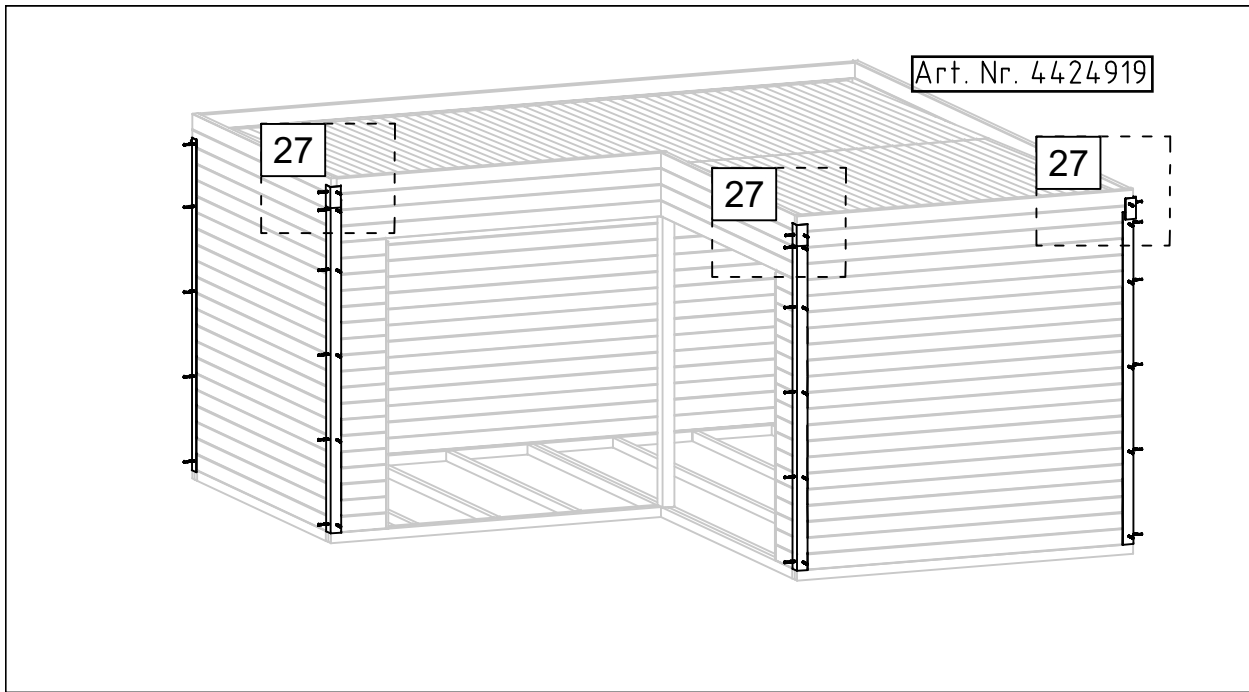

12.03.2020

22/27

Art. Nr. 4424919

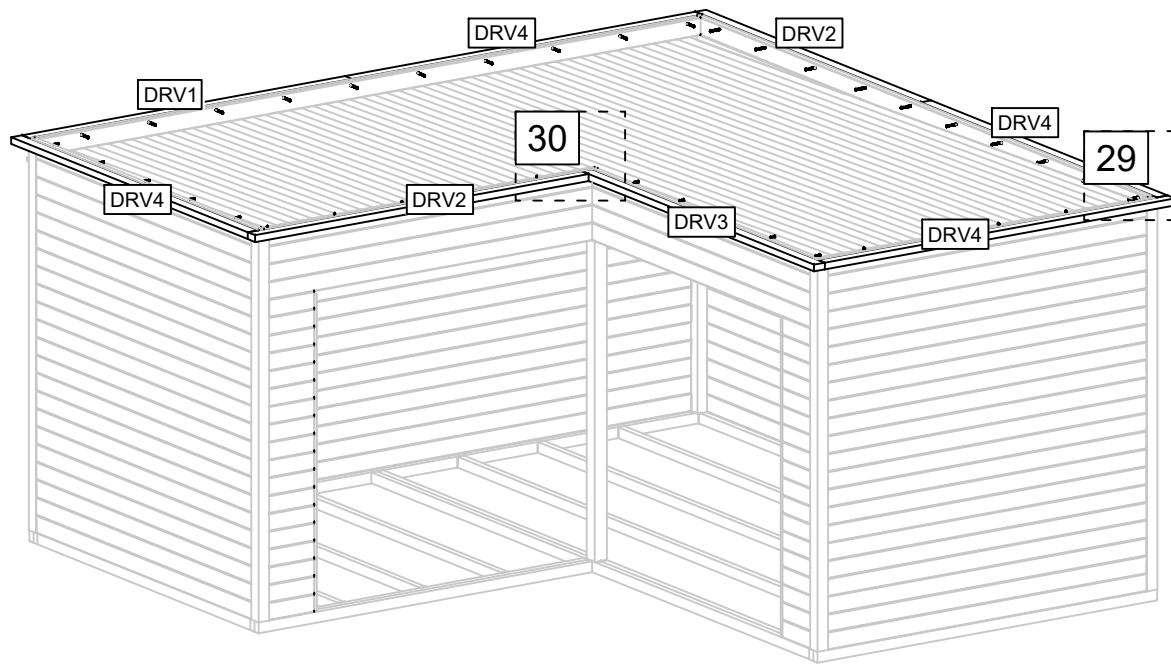

29

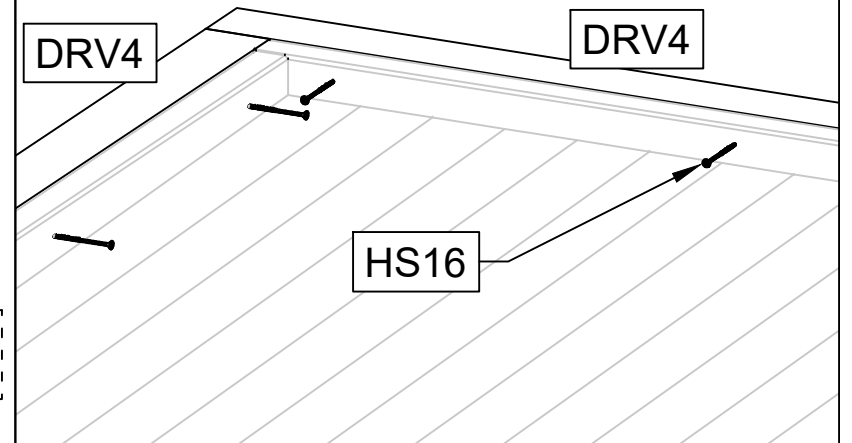

30

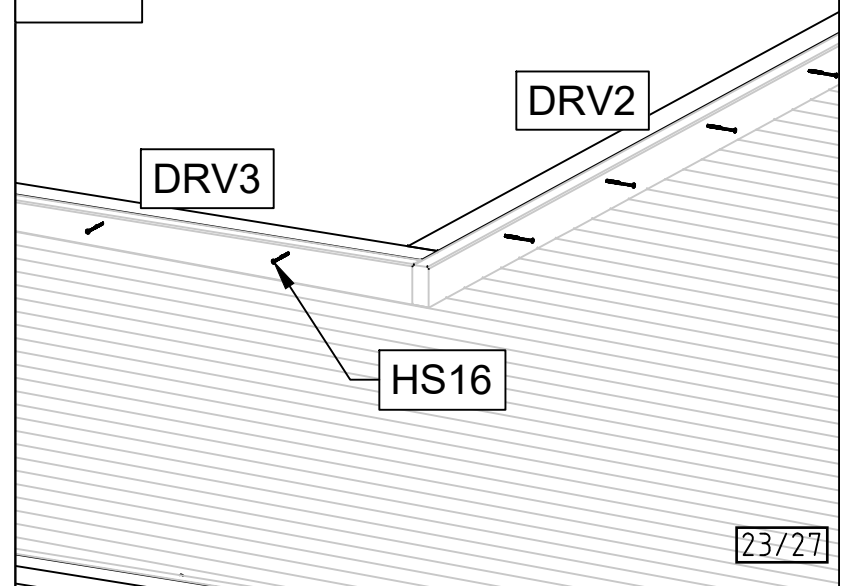

12.03.2020

23/27

Art. Nr. 4424919

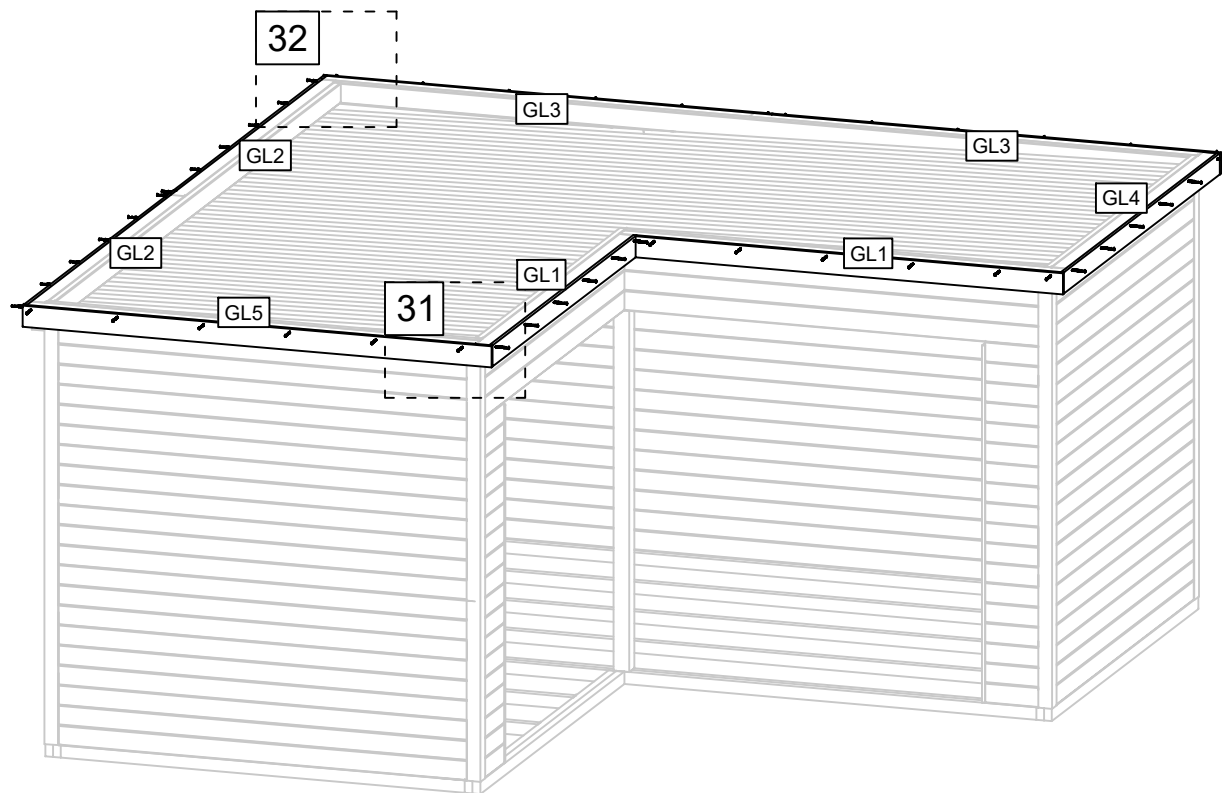

31

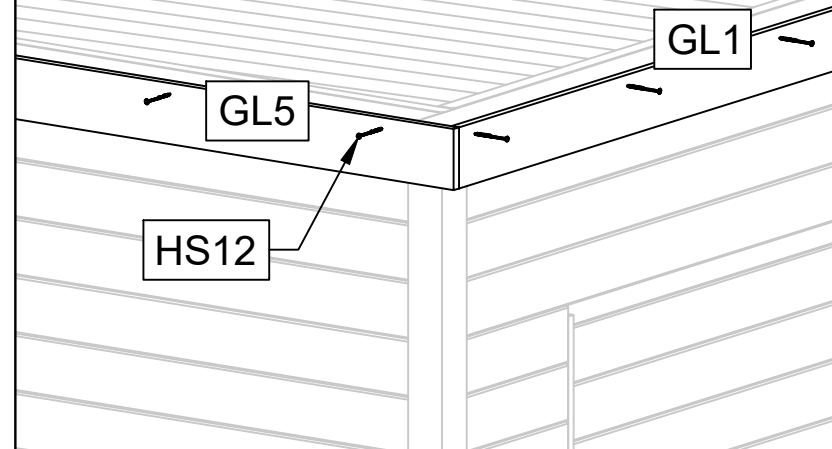

32

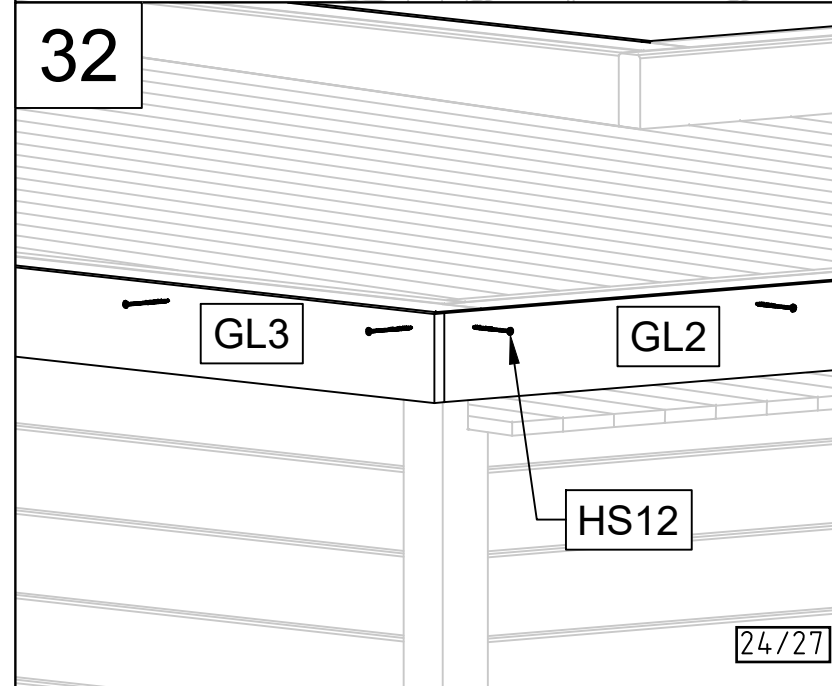

12.03.2020

24/27

Art. Nr. 4424919

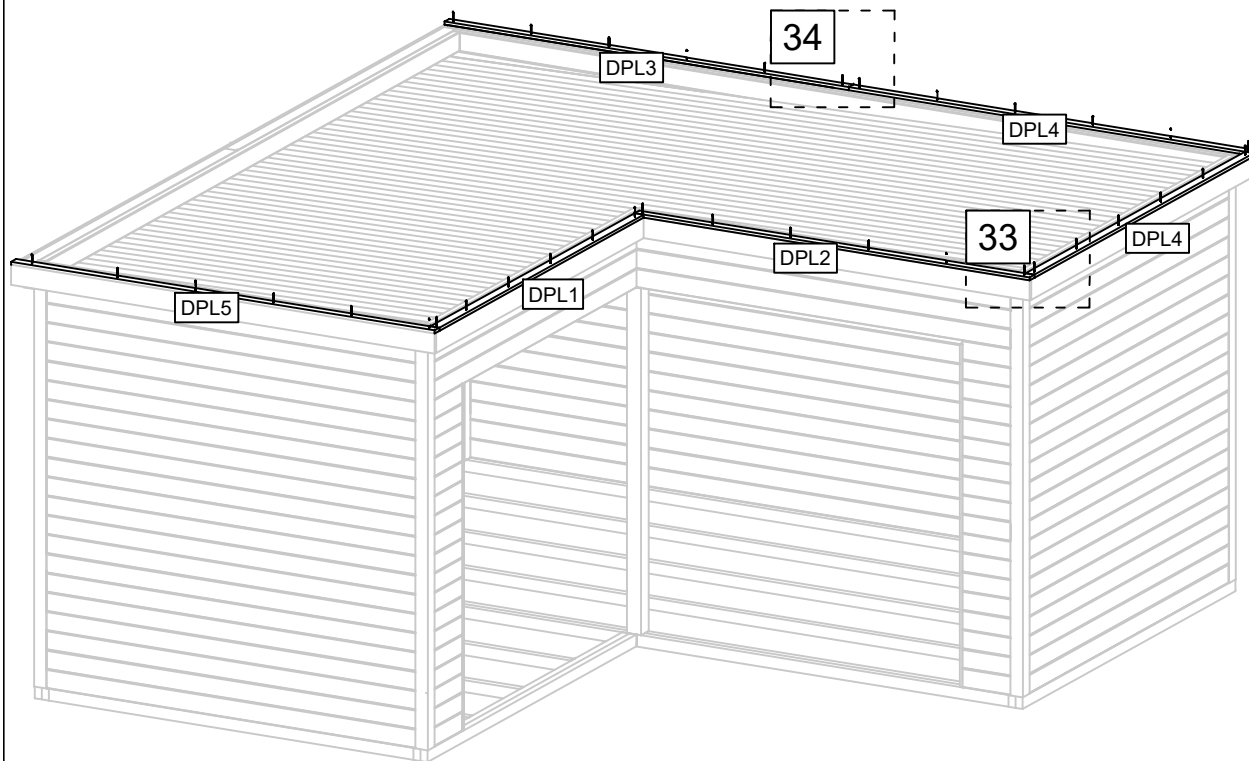

33

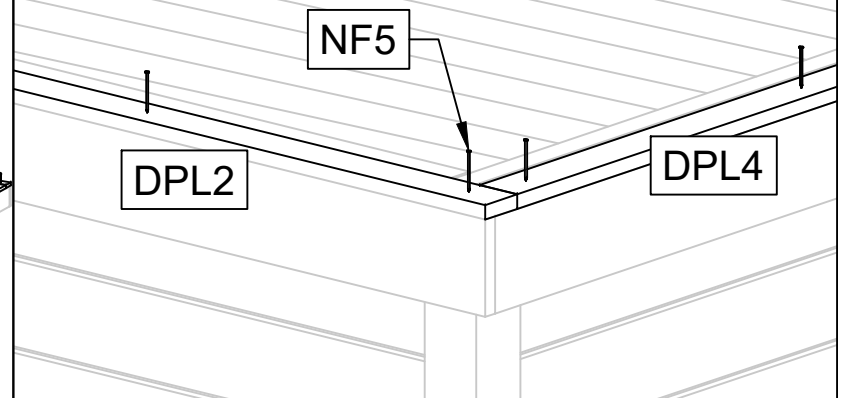

34

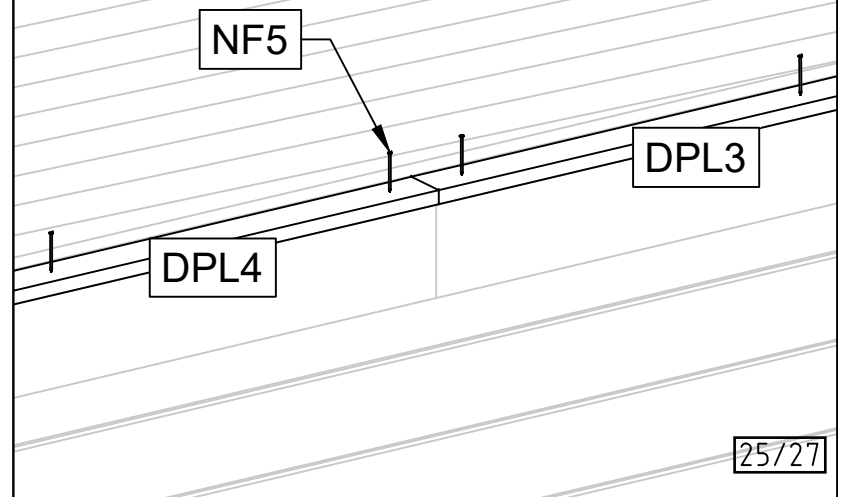

12.03.2020

25/27

Art. Nr. 4424919

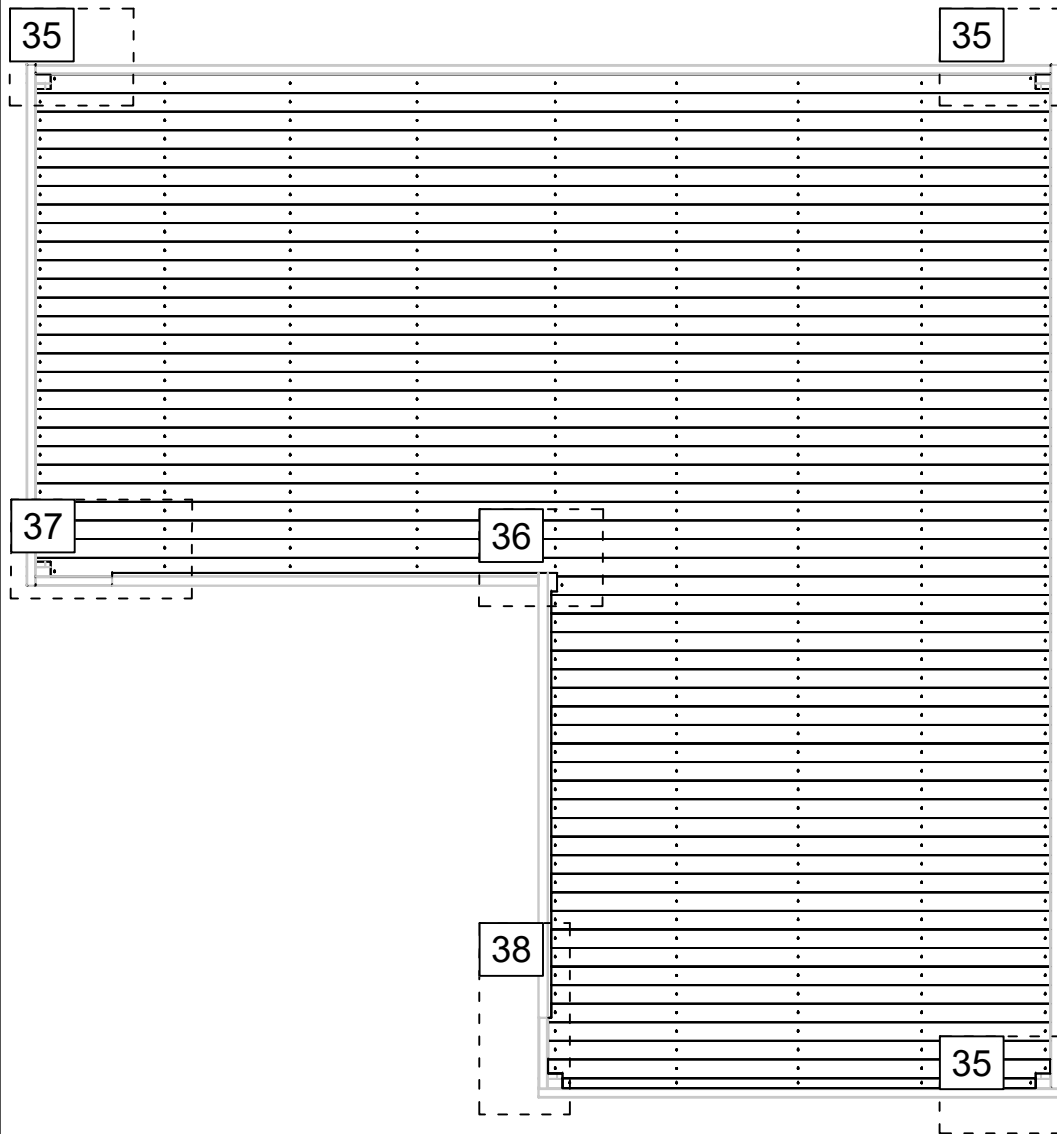
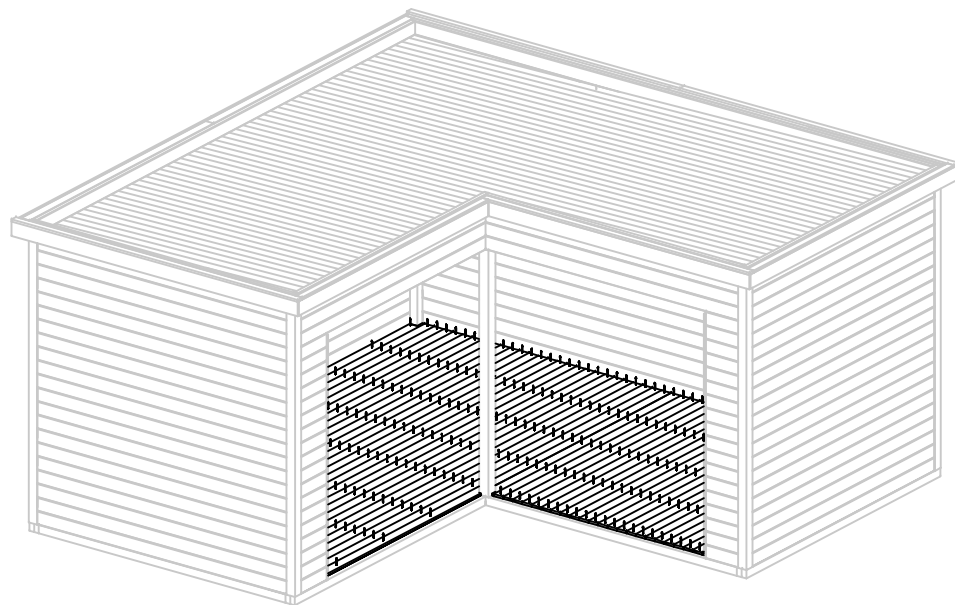

12.03.2020

35

Art. Nr. 4424919

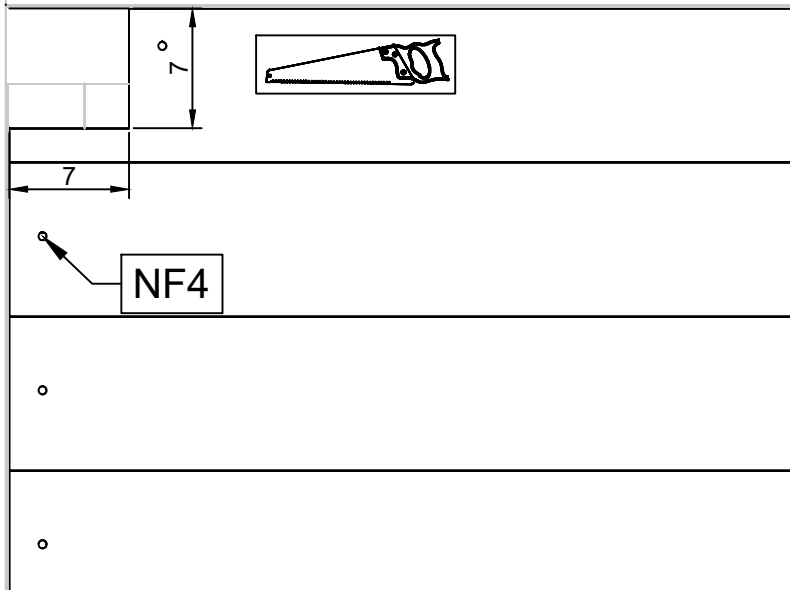

36

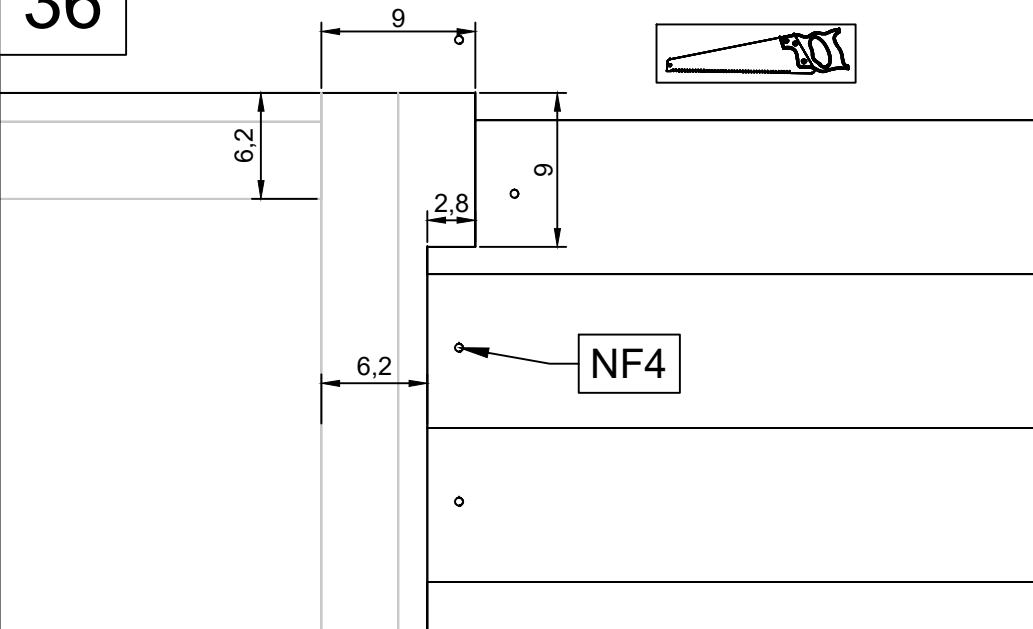

37

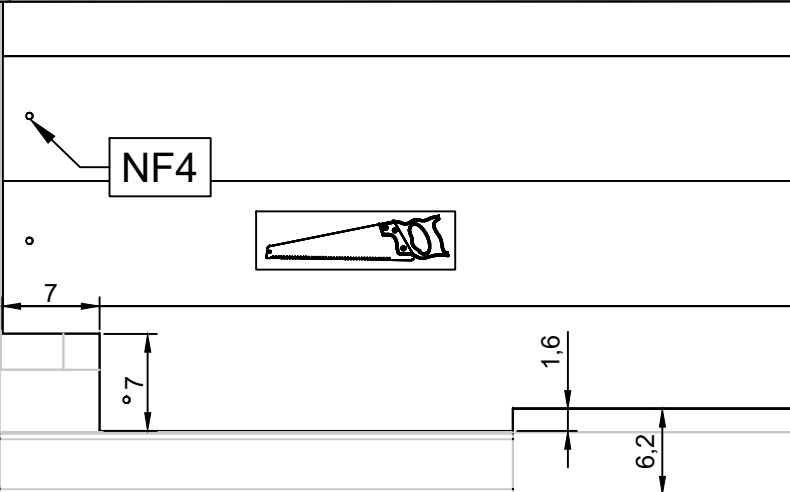

38

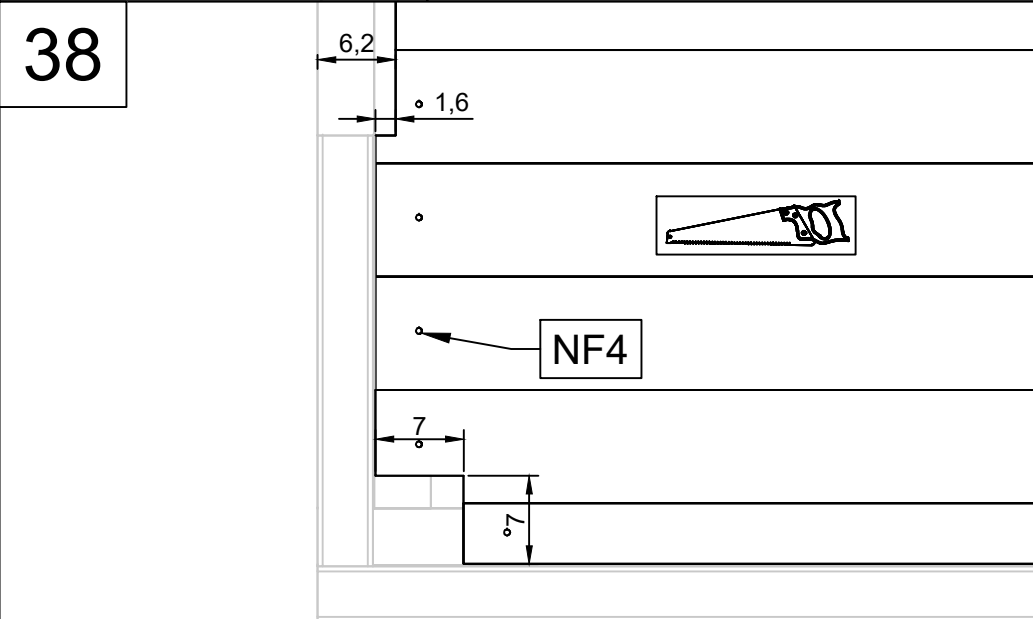

12.03.2020

27/27

Pos	10.11.2020	Piece list - Stückliste - Liste des pièces - Elementi - Stuklijst - Tükítabel 2041x2026 ALP.2S.2R. RAL7016	1/1	Q	P (mm)	L (mm)
-----	------------	---	-----	---	-----------	-----------

Glass size - Glasgröße - Taille de la vitre - Misura del vetro - Glas afmeting - Klaasi mõõt: 926x1859 mm

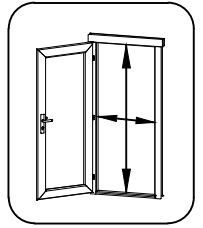

950x1930 mm

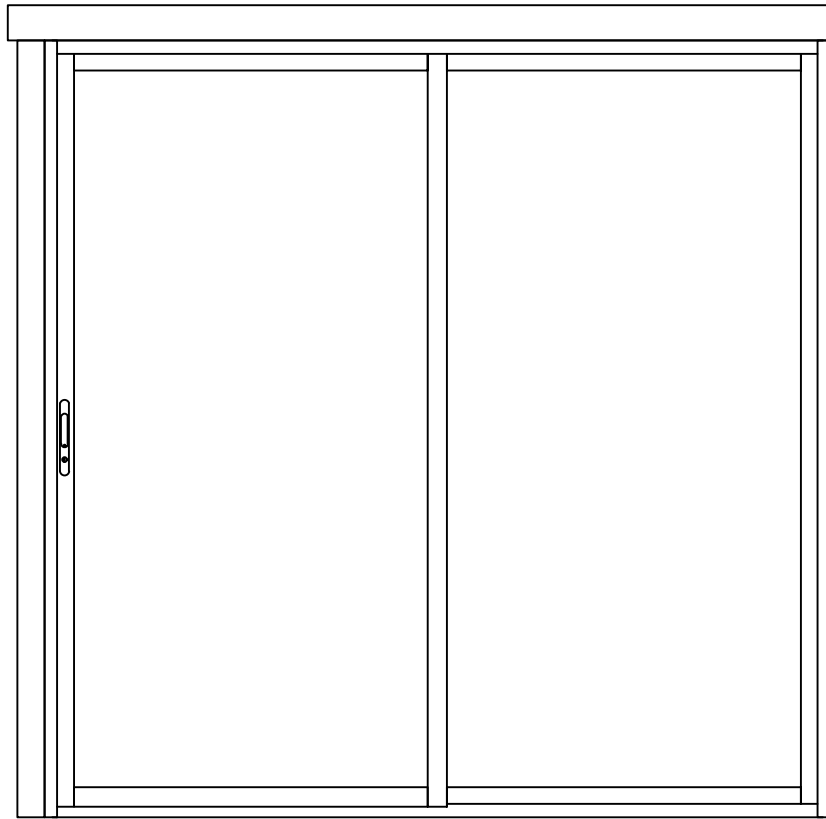

12	Upper door jamb - Türrahmen oben - Cadre de porte supérieur - Telaio superiore della porta - Bovendorpet - Ükse ütemine teng		1	35x60	1982
9	Doorstep - Swelle - Seuil de porte - Callare - Drempel - Lävepakk ukseavale		1	35x60	1982
10-11	Door jamb - Türrahmen - Cadre de porte - Telaio montante della porta - Deurframe - Ükse teng		2	32x63	2000

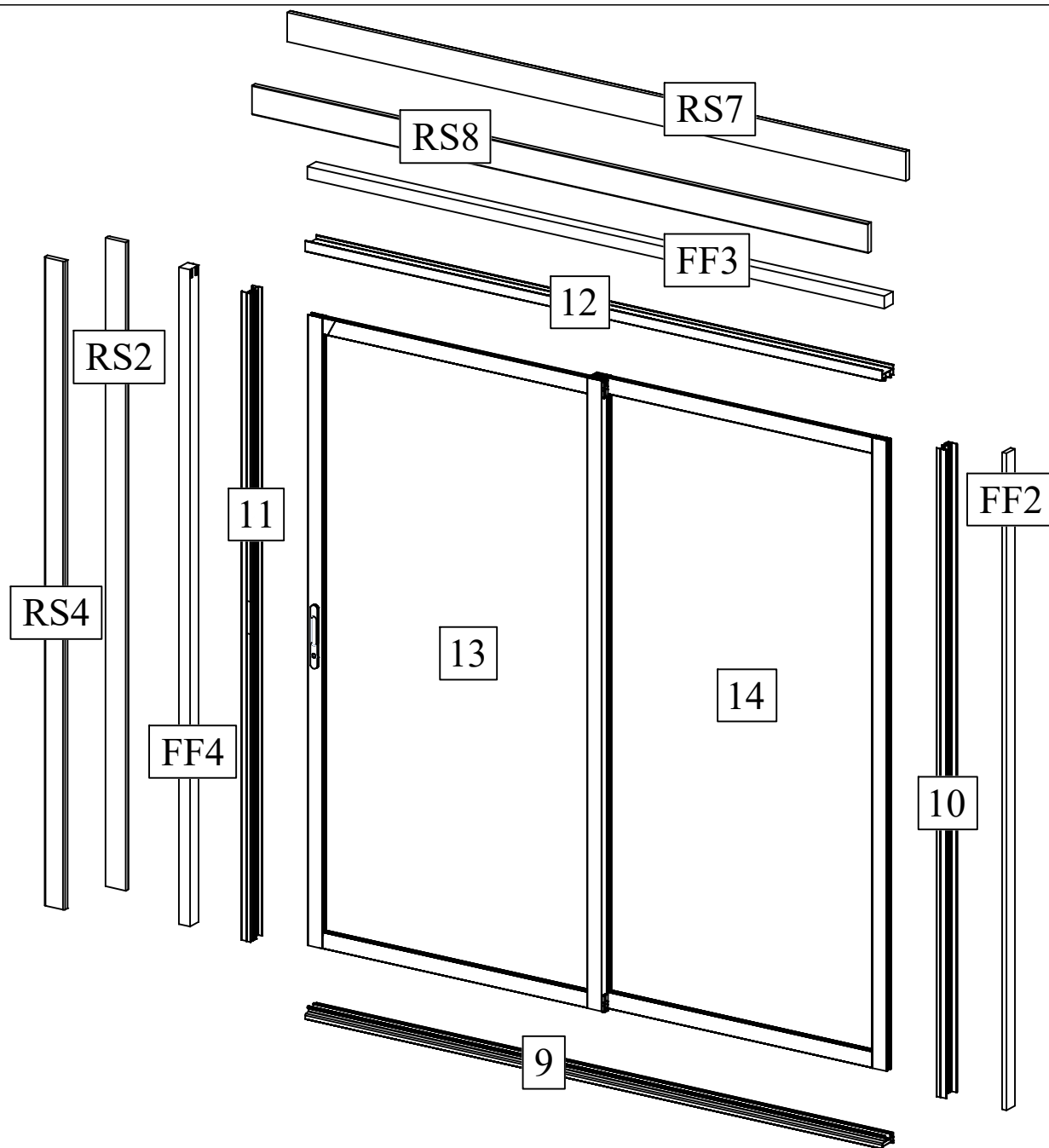

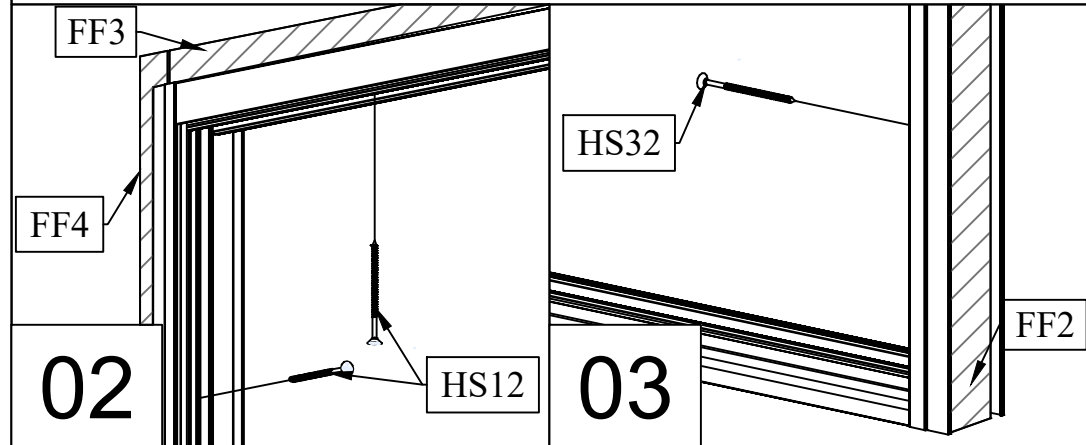
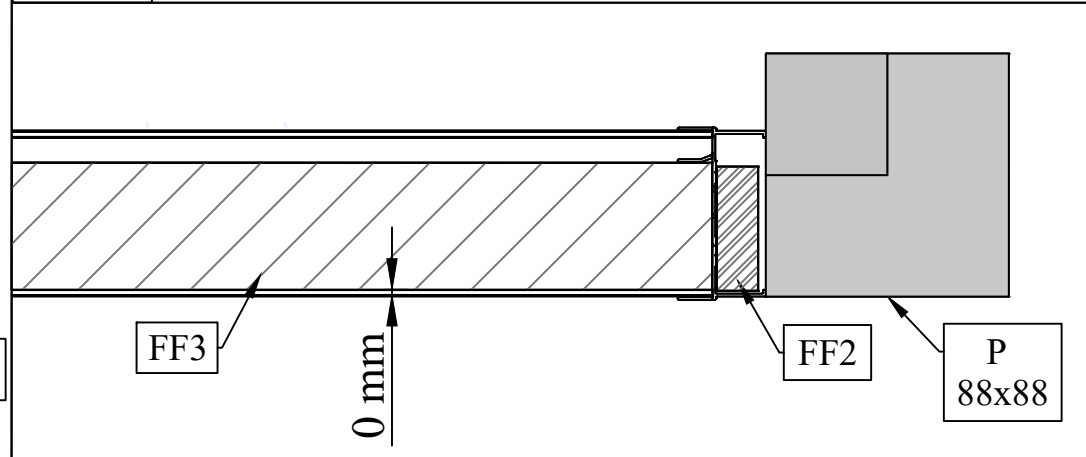
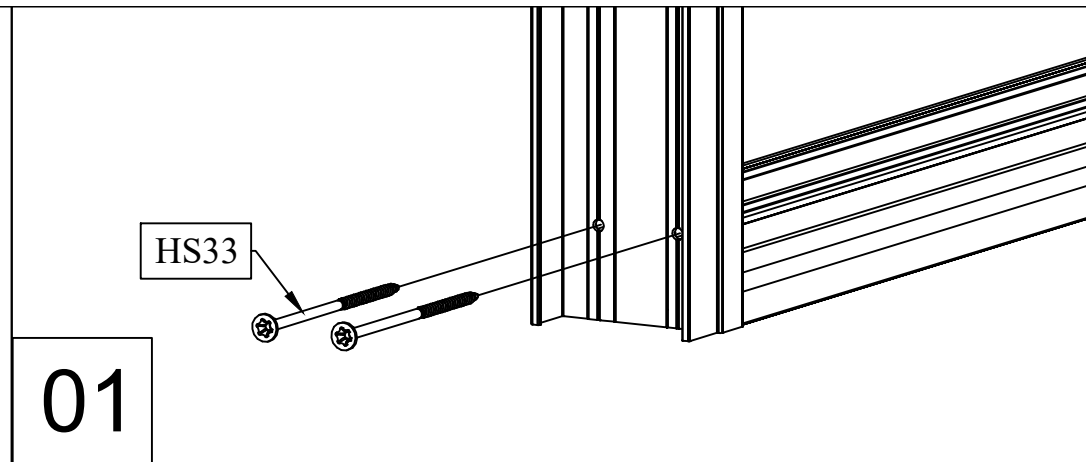
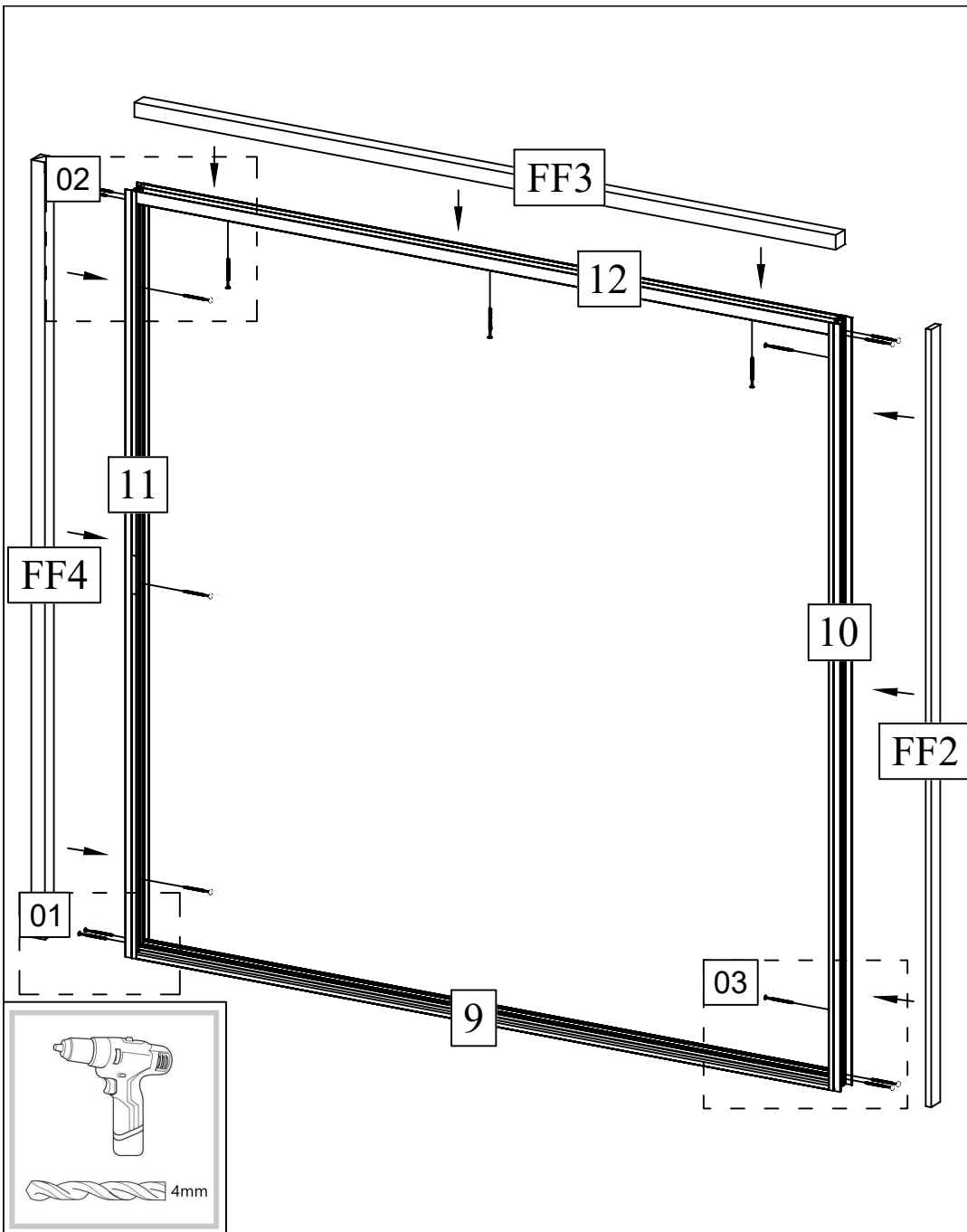

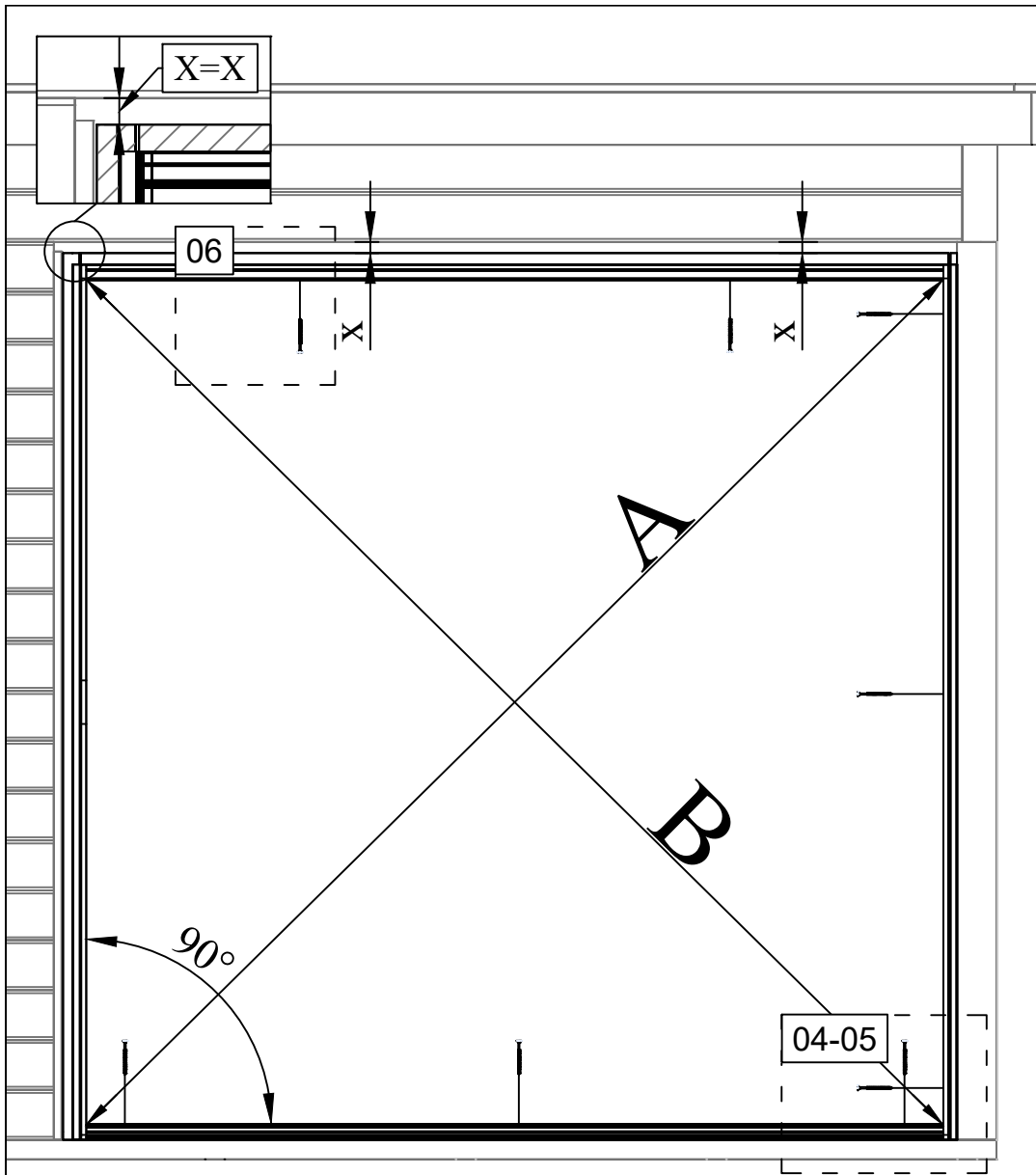

A=B

04

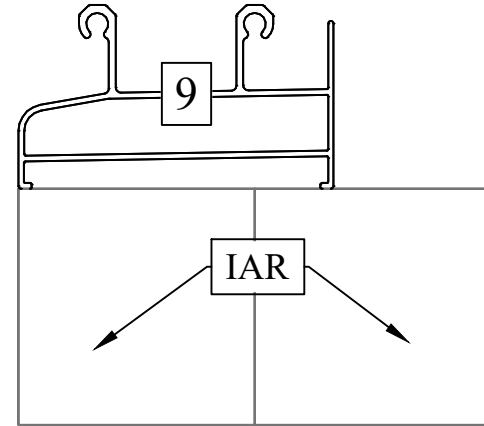

05

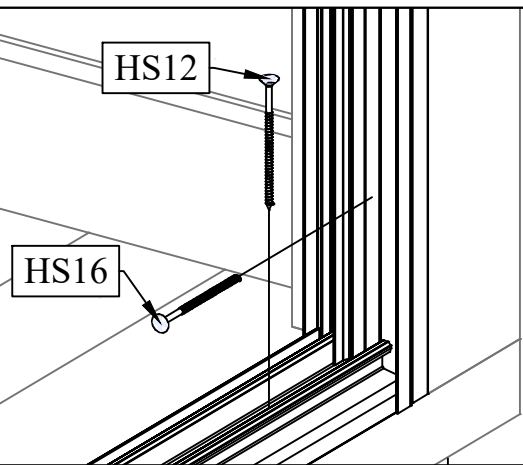

06

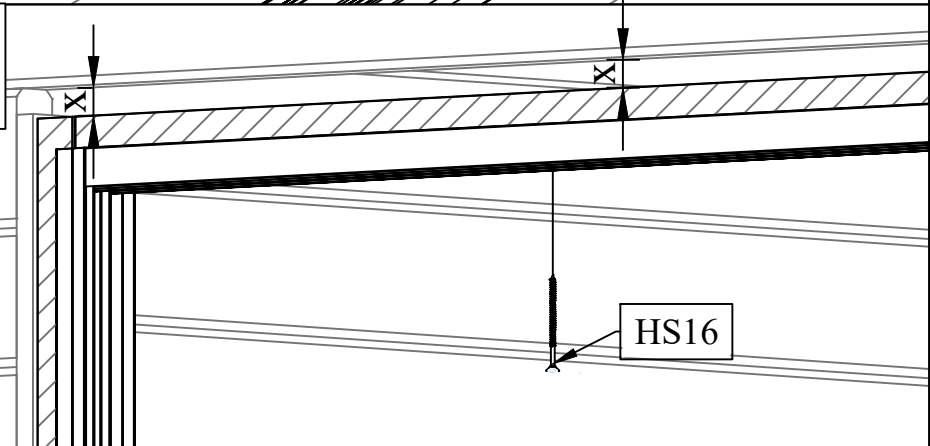

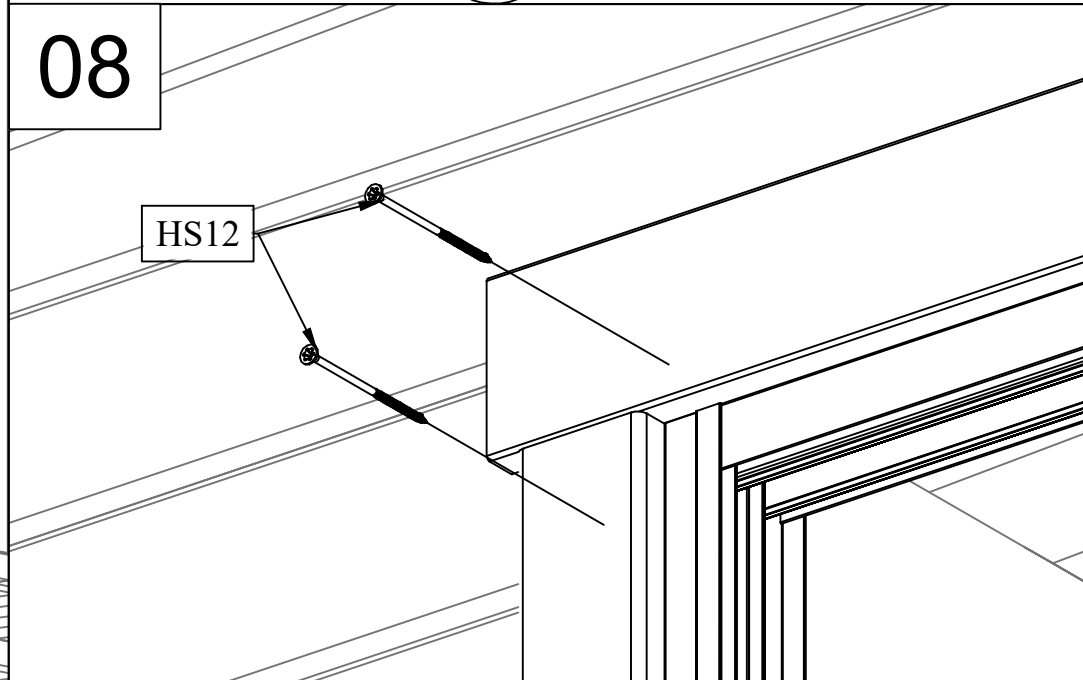
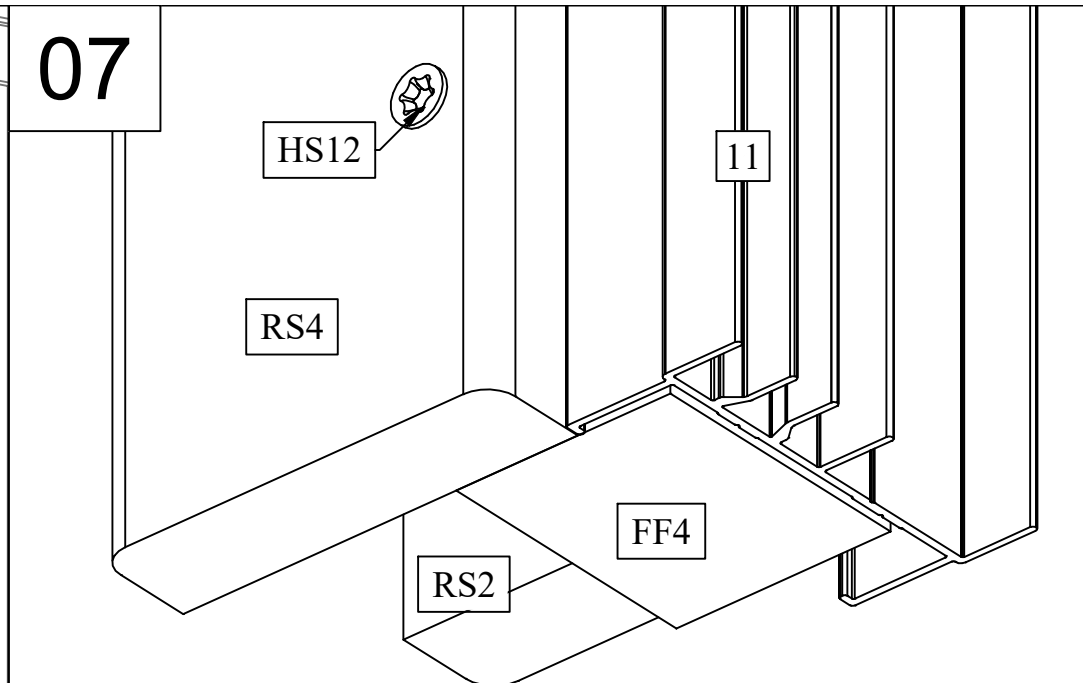
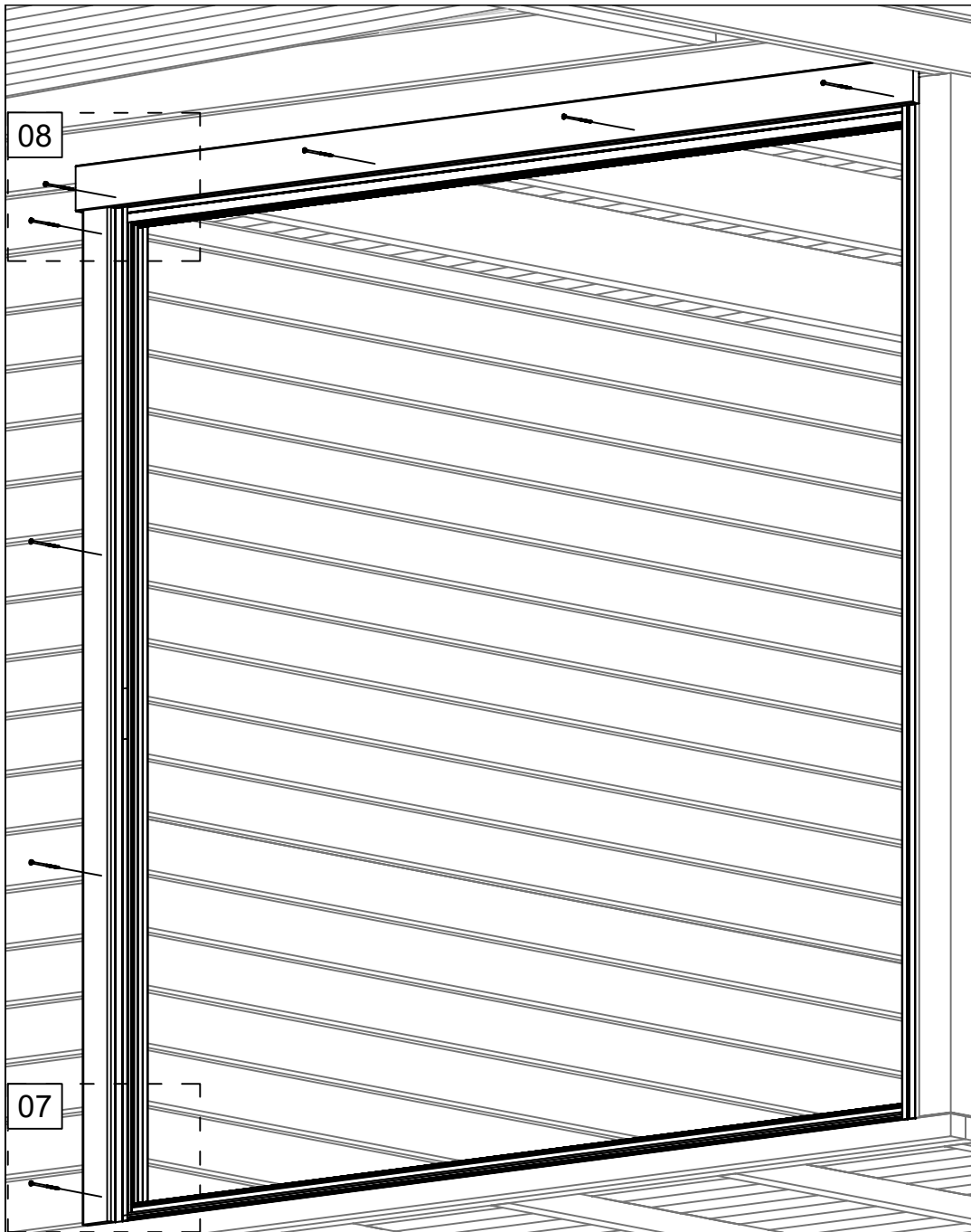

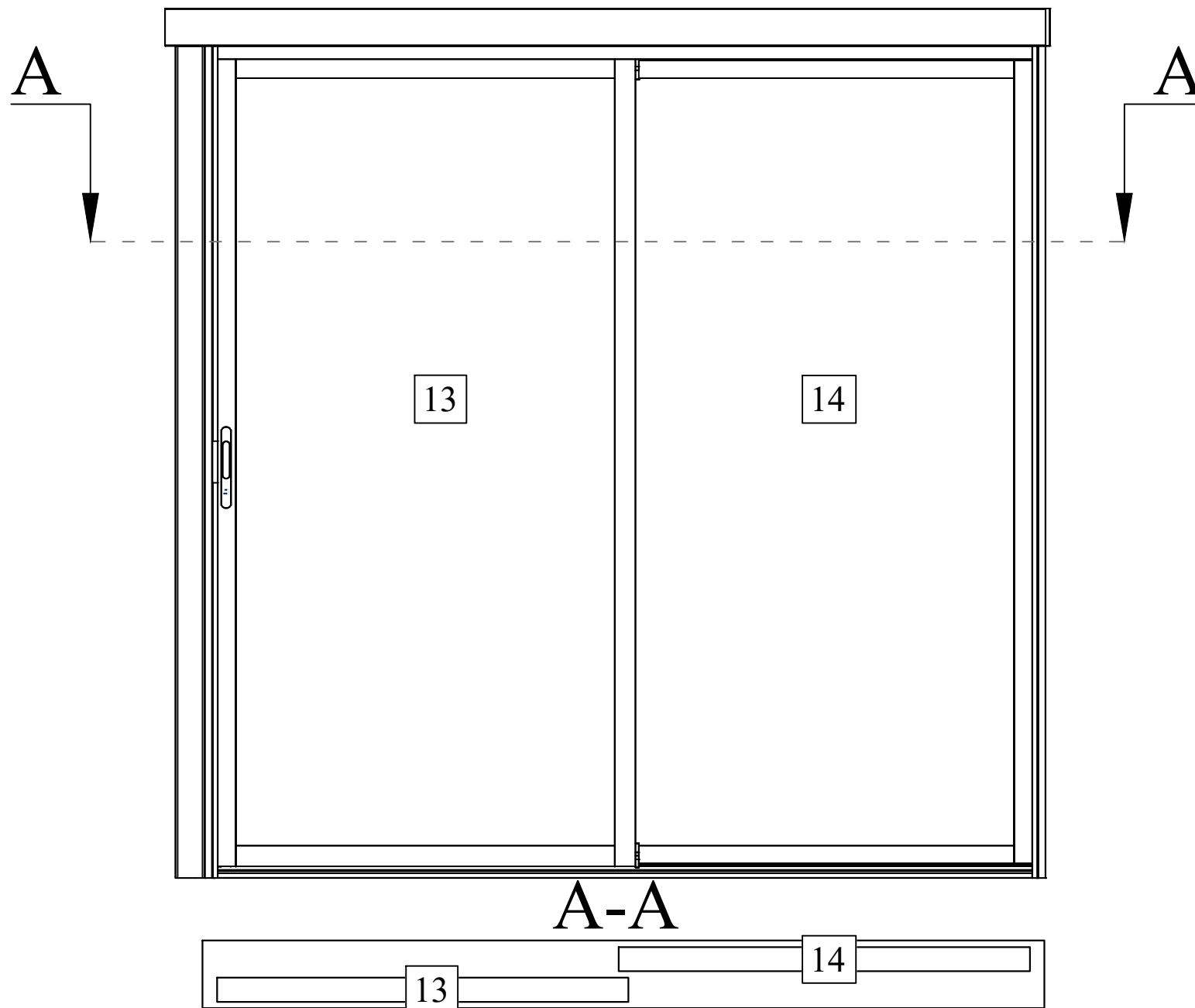

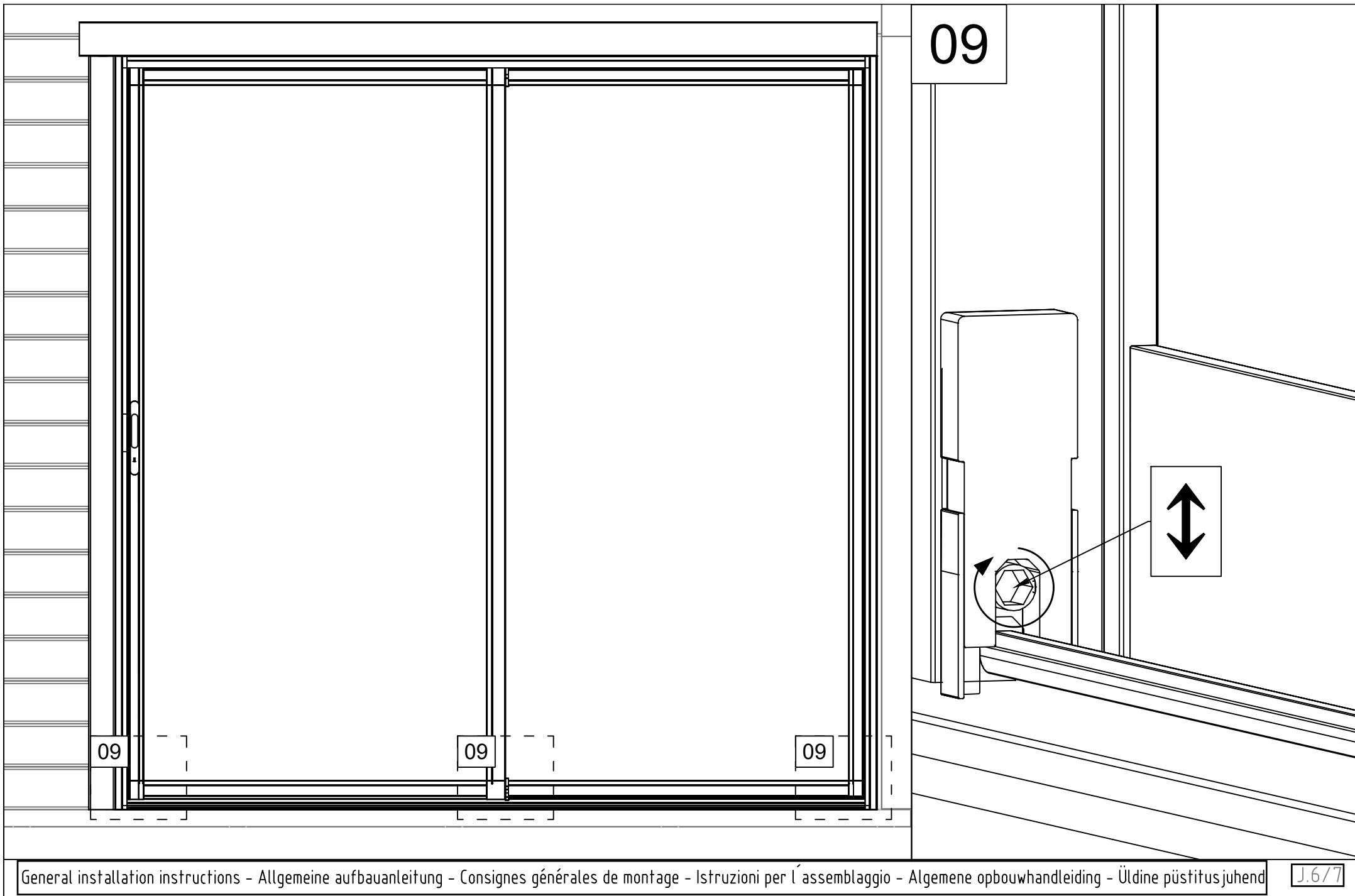

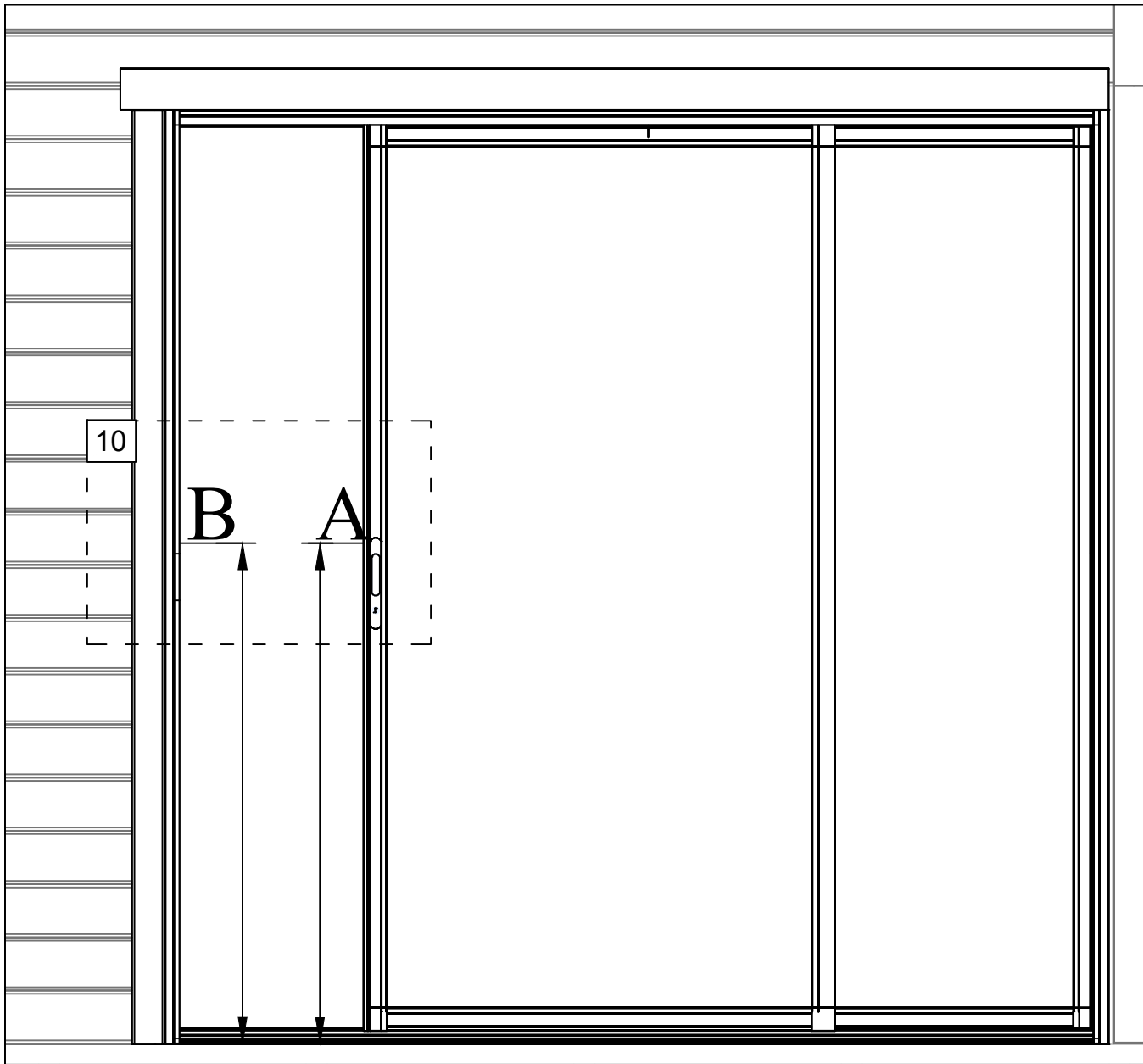

$$A=B$$

10

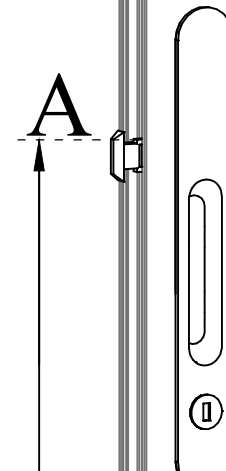

10

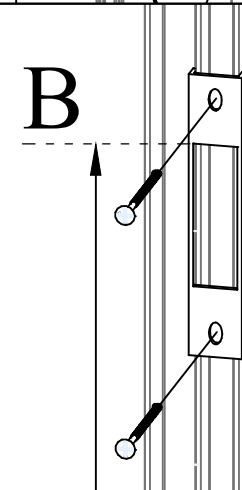

B



A

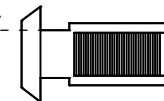

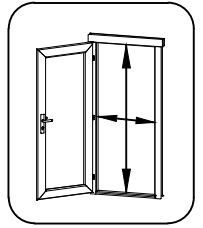

Pos	14.01.2020	Piece list - Stückliste - Liste des pièces - Elementi - Stuklijst - Tükítabel 2041x2026 AL.2S.2R.P RAL7016	1/1	Q	P (mm)	L (mm)
-----	------------	---	-----	---	-----------	-----------

Glass size - Glasgröße - Taille de la vitre - Misura del vetro - Glas afmeting - Klaasi mõõt: 926x1859 mm

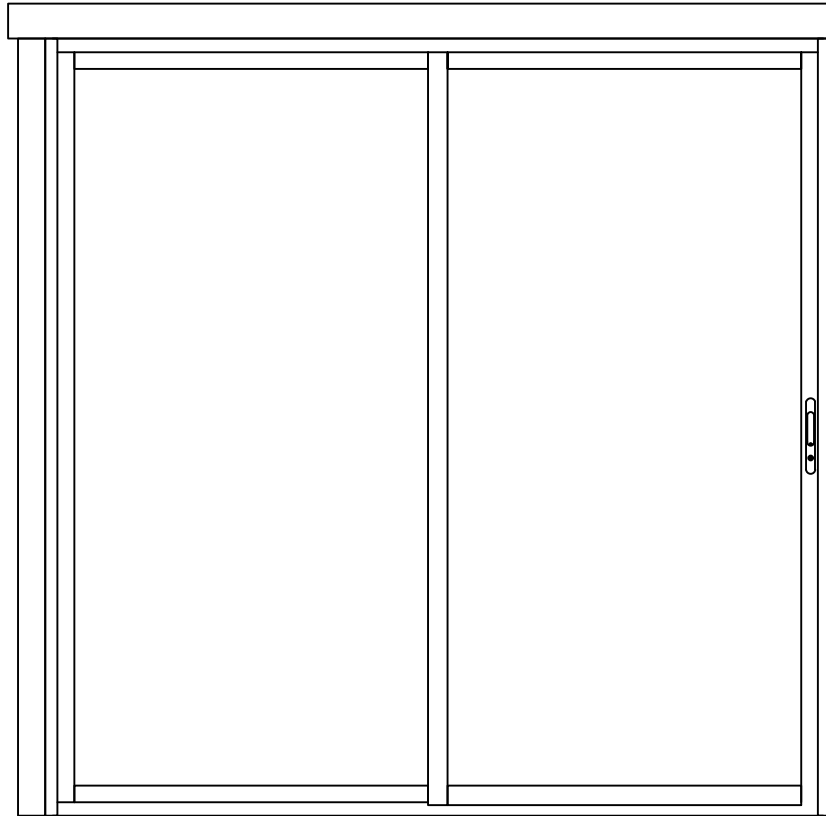

950x1930 mm

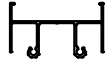

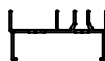
12	Upper door jamb - Türrahmen oben - Cadre de porte supérieur - Telaio superiore della porta - Bovendorpel - Ukse ütemine teng		1	35x60	1982
9	Doorstep - Swelle - Seuil de porte - Callare - DrempeL - Lävopak ukseavale		1	35x60	1982
10-11	Door jamb - Türrahmen - Cadre de porte - Telaio montante della porta - Deurframe - Ukse teng		2	32x63	2000

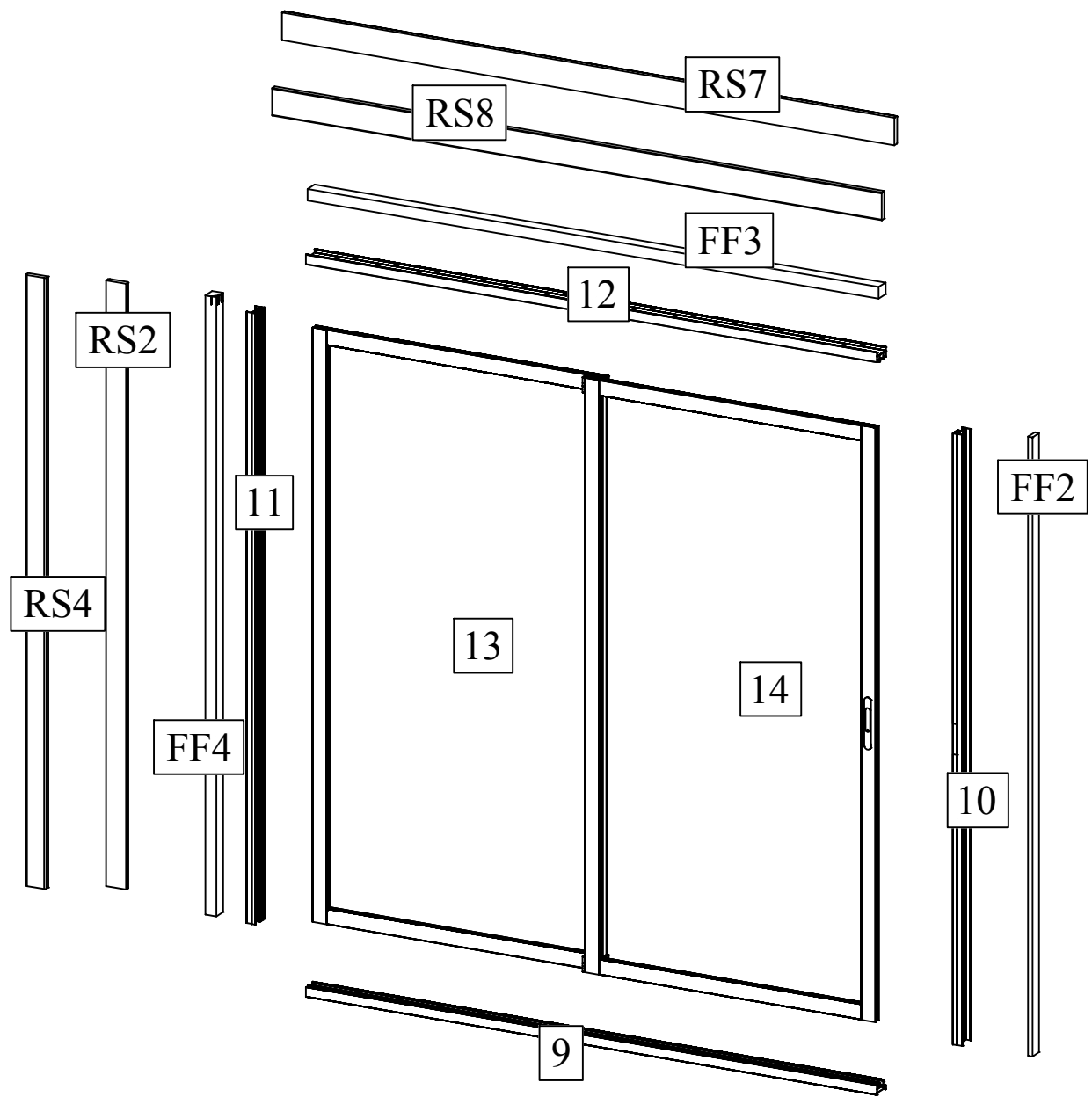

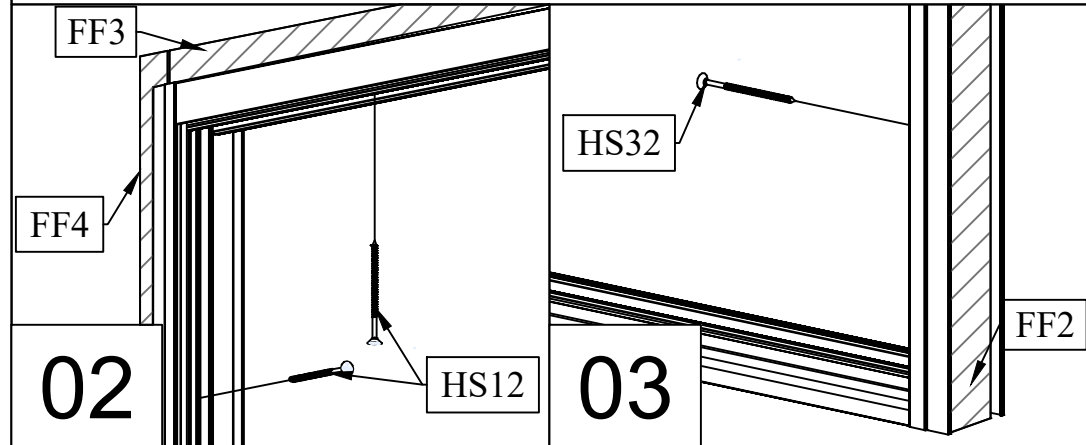
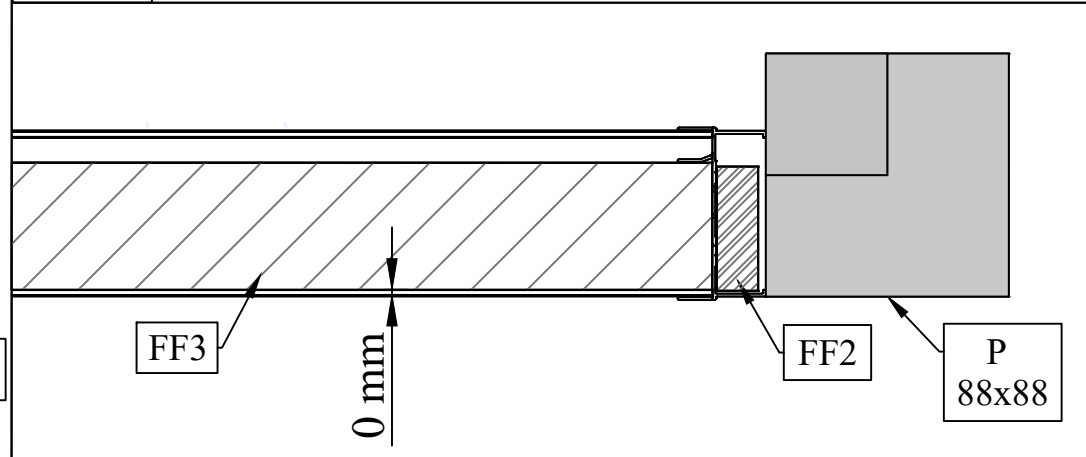
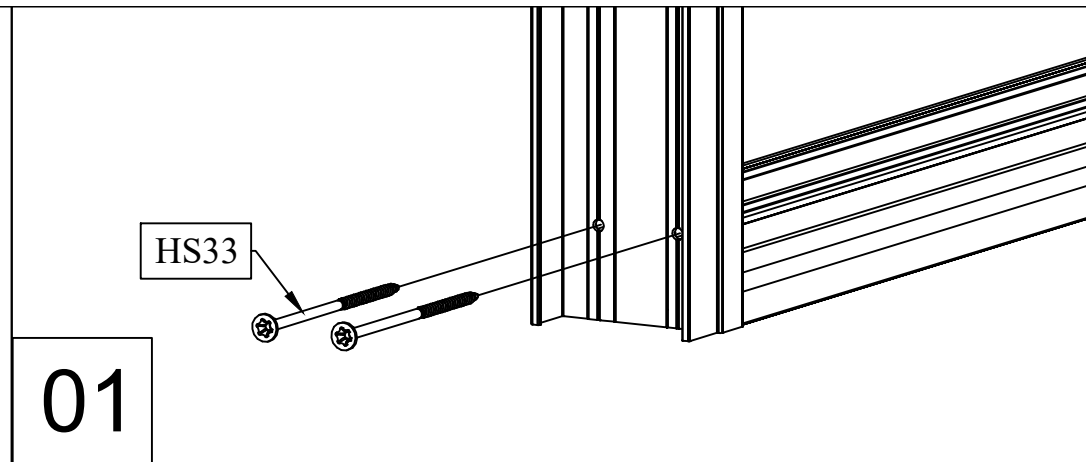
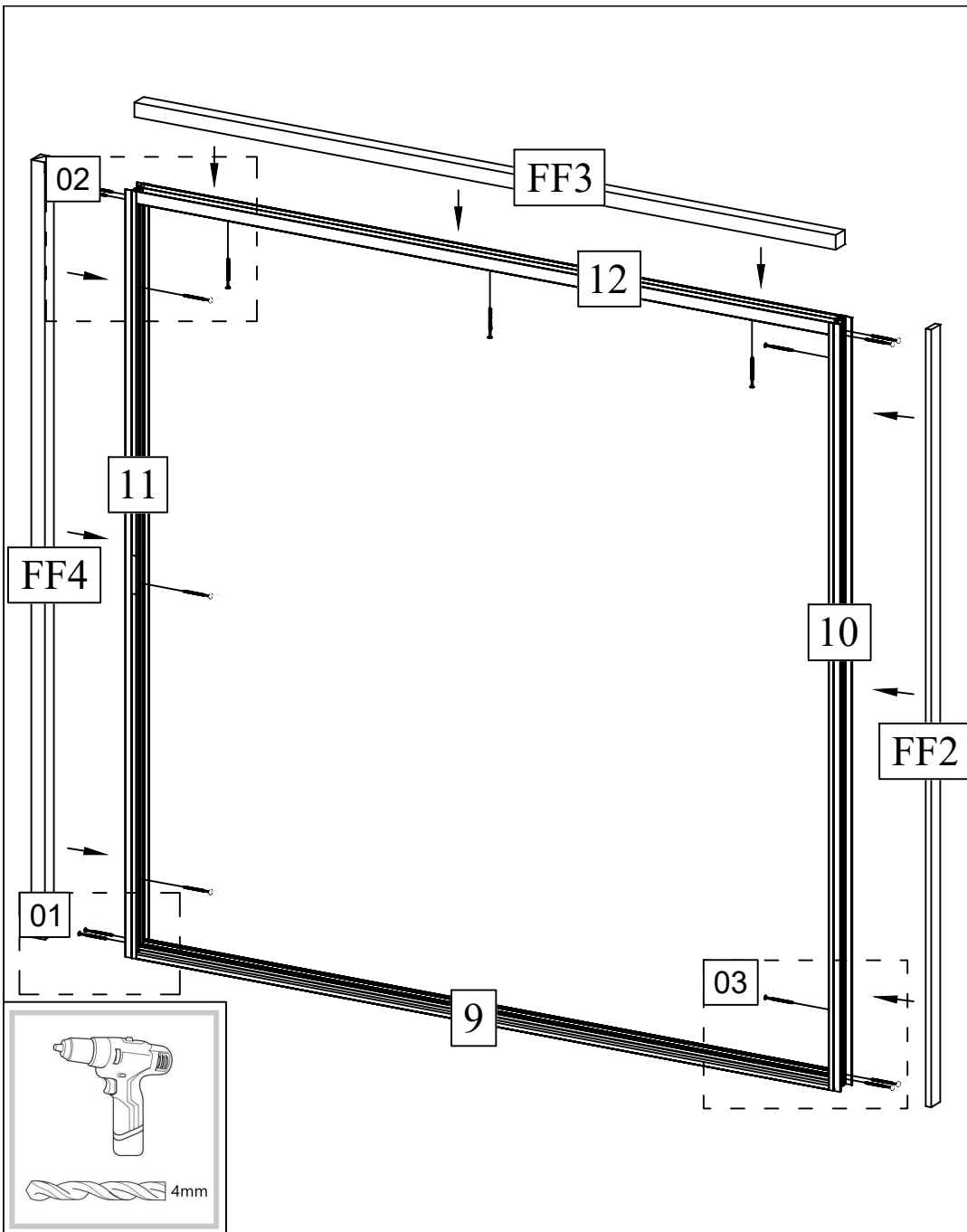

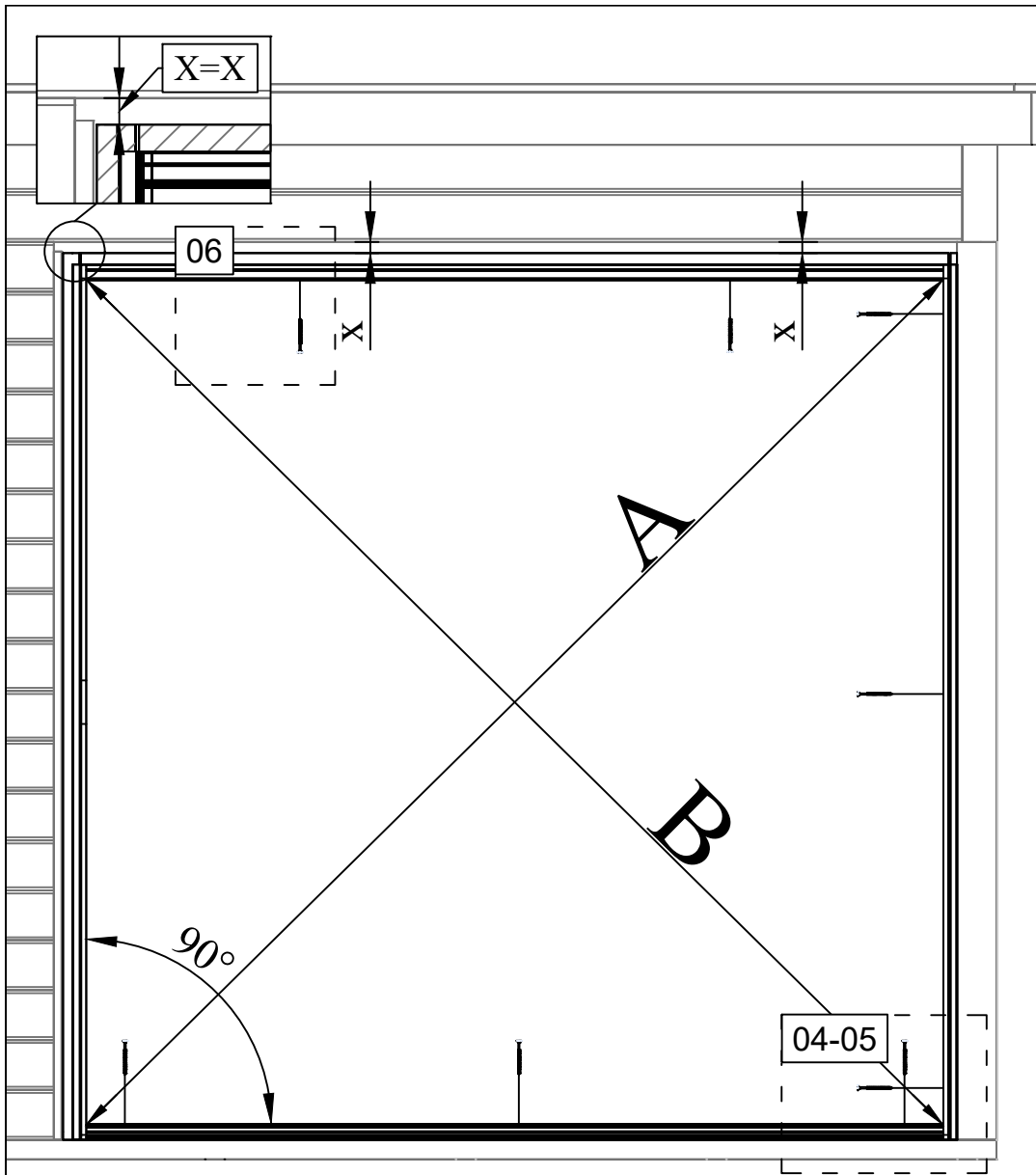

A=B

04

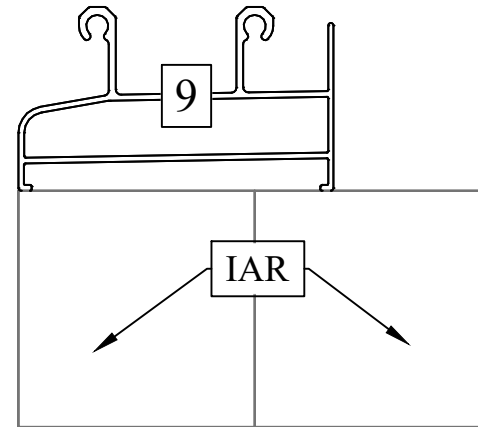

05

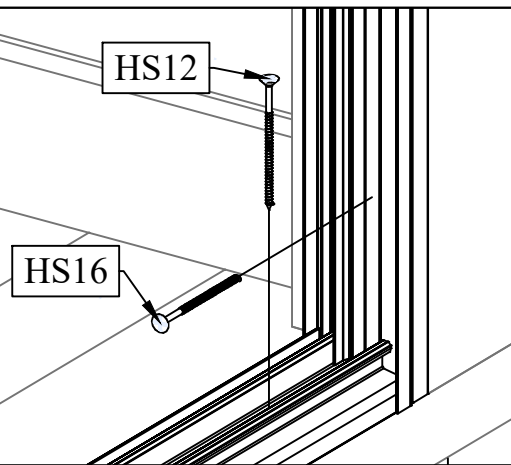

06

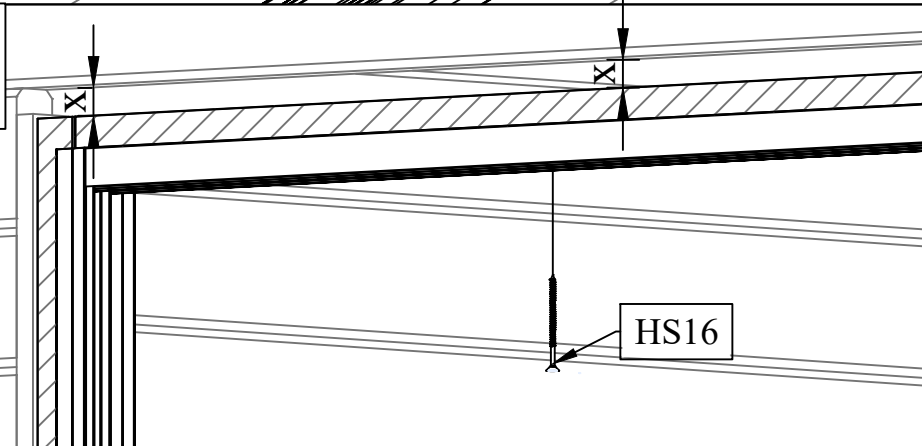

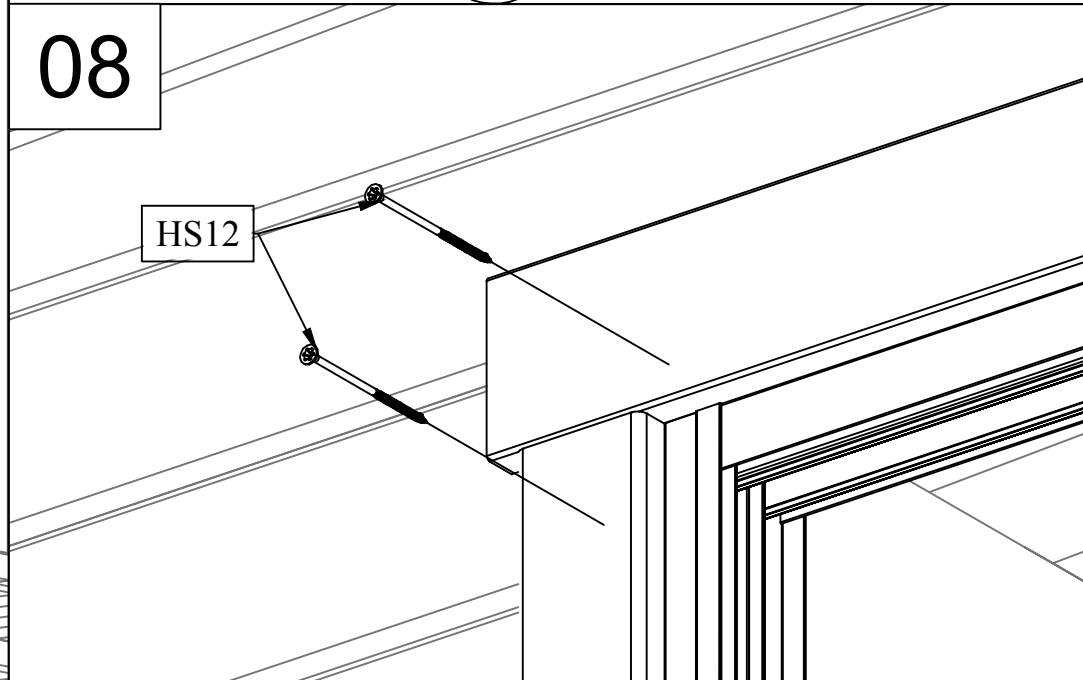
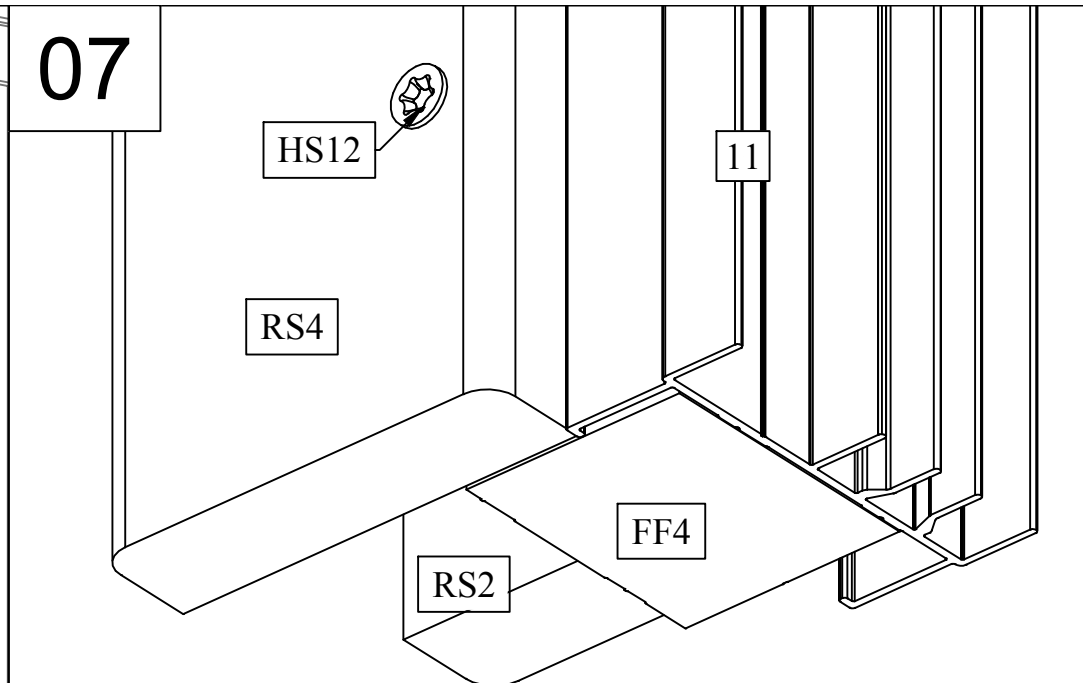
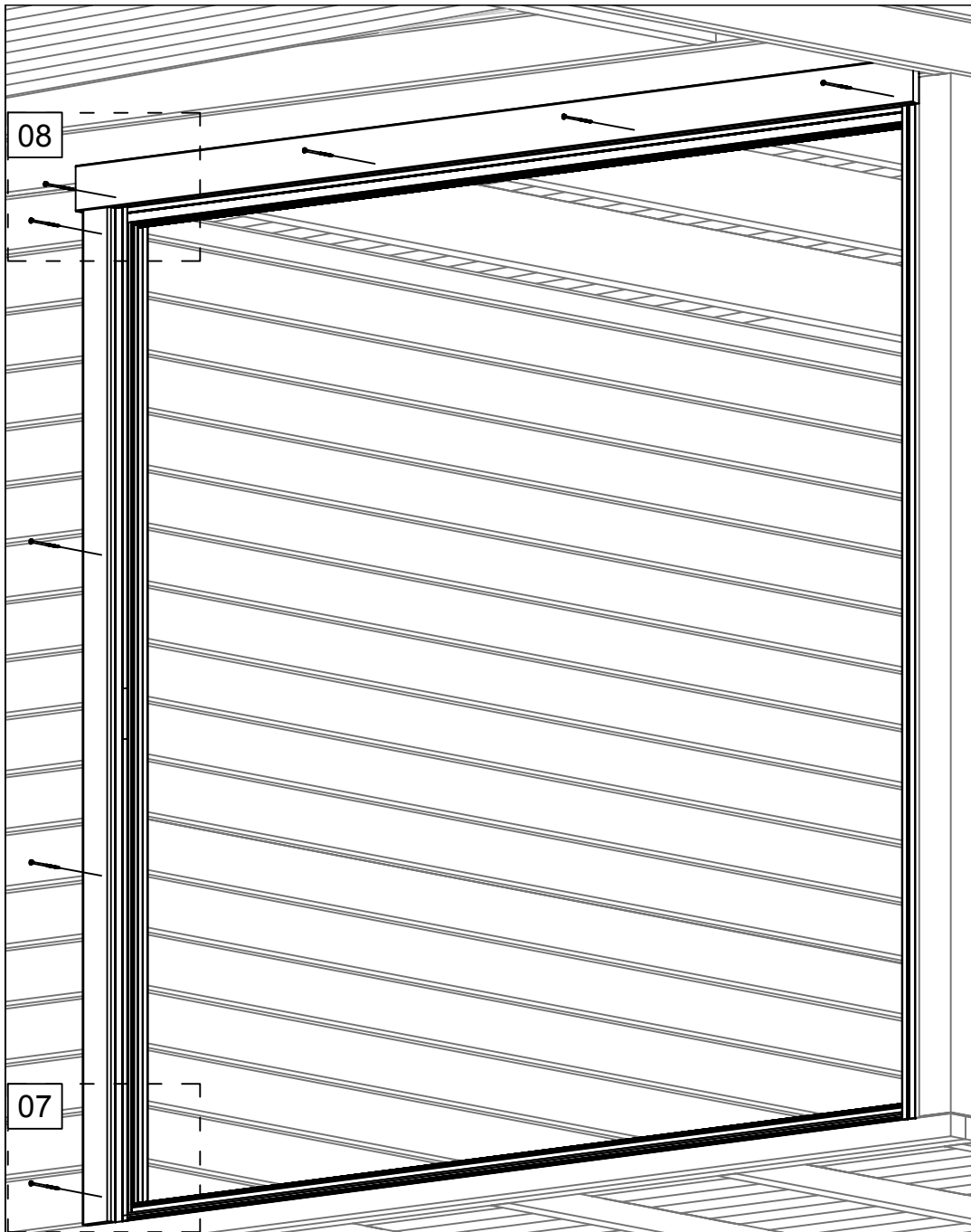

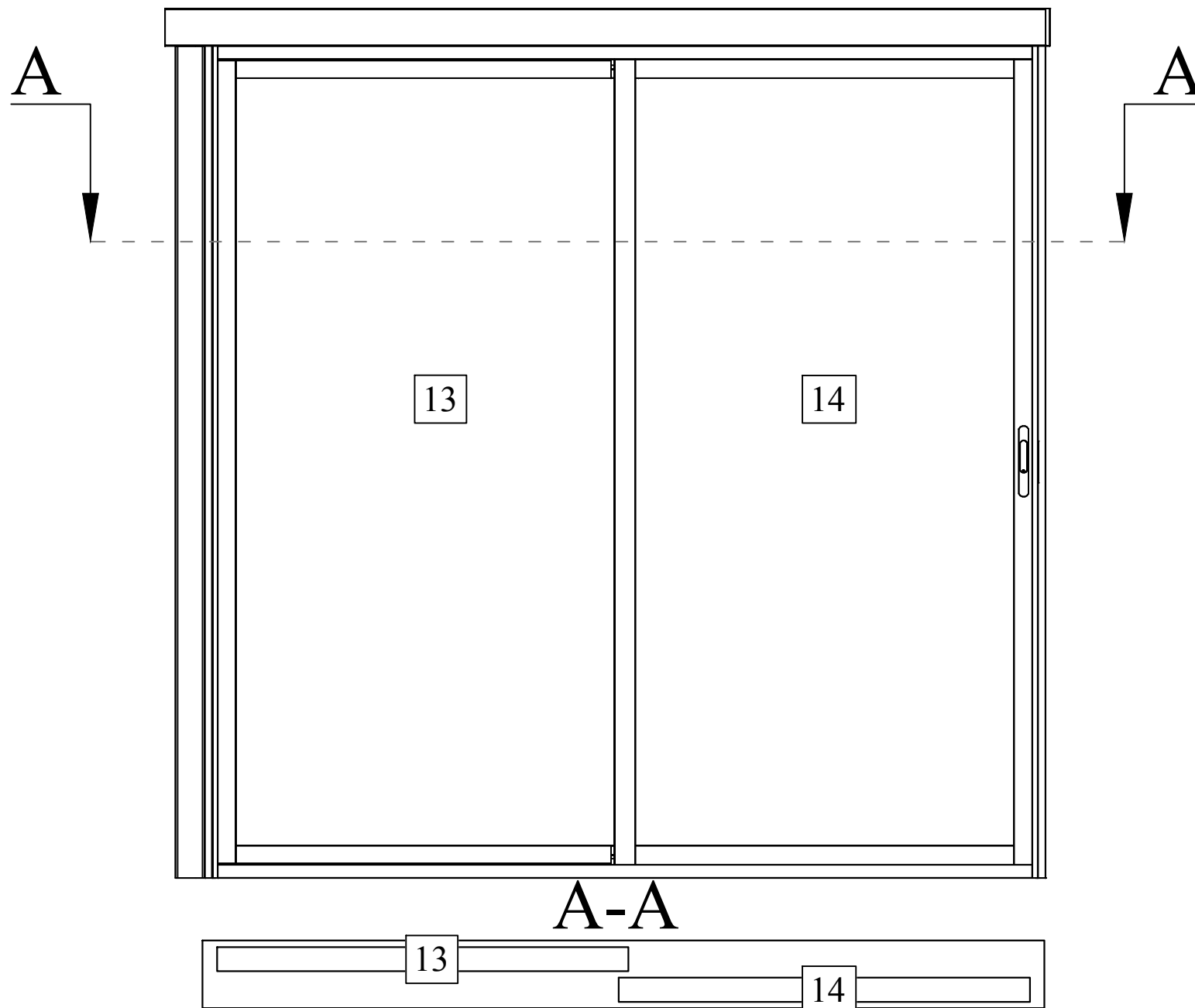

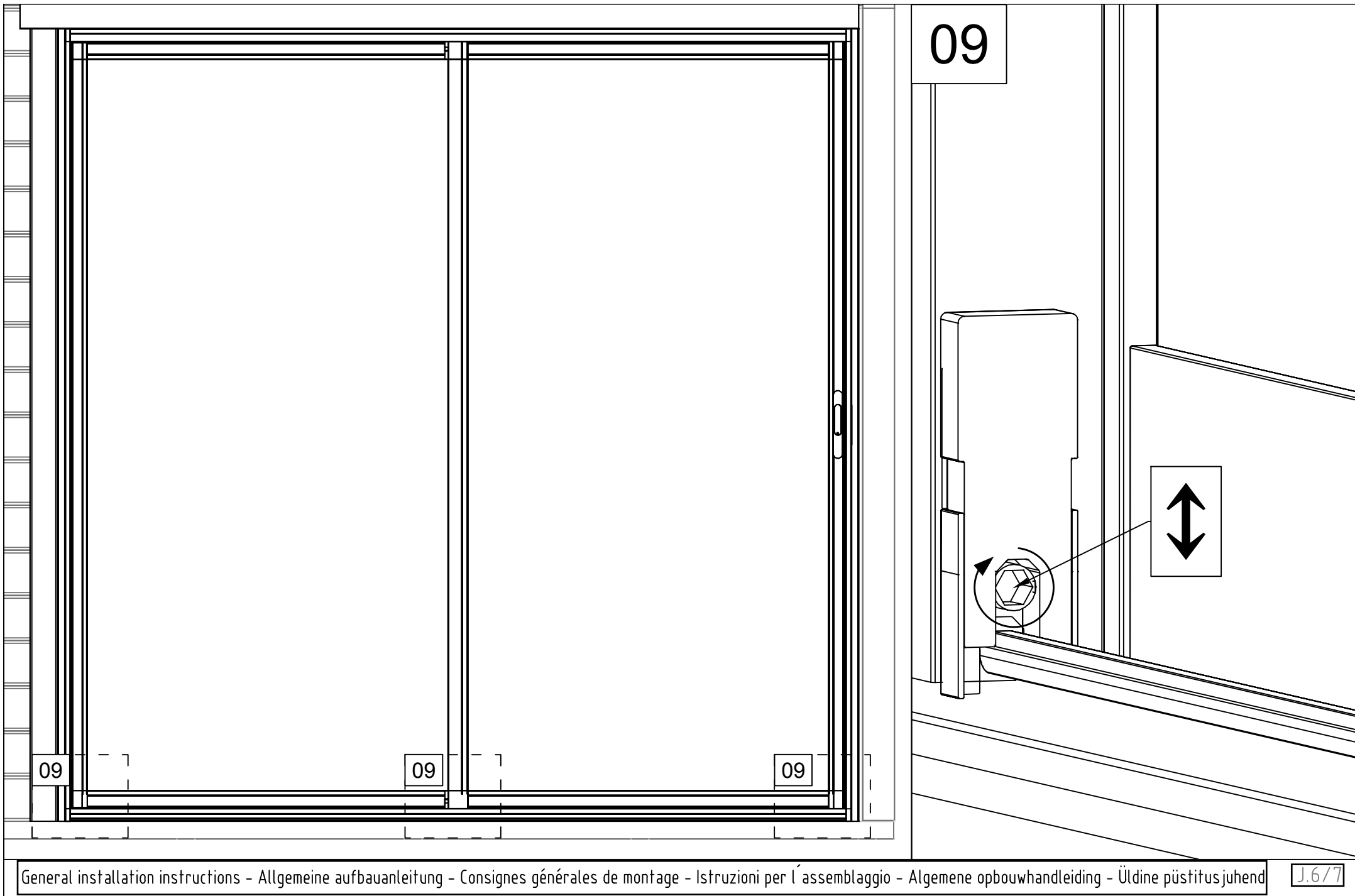

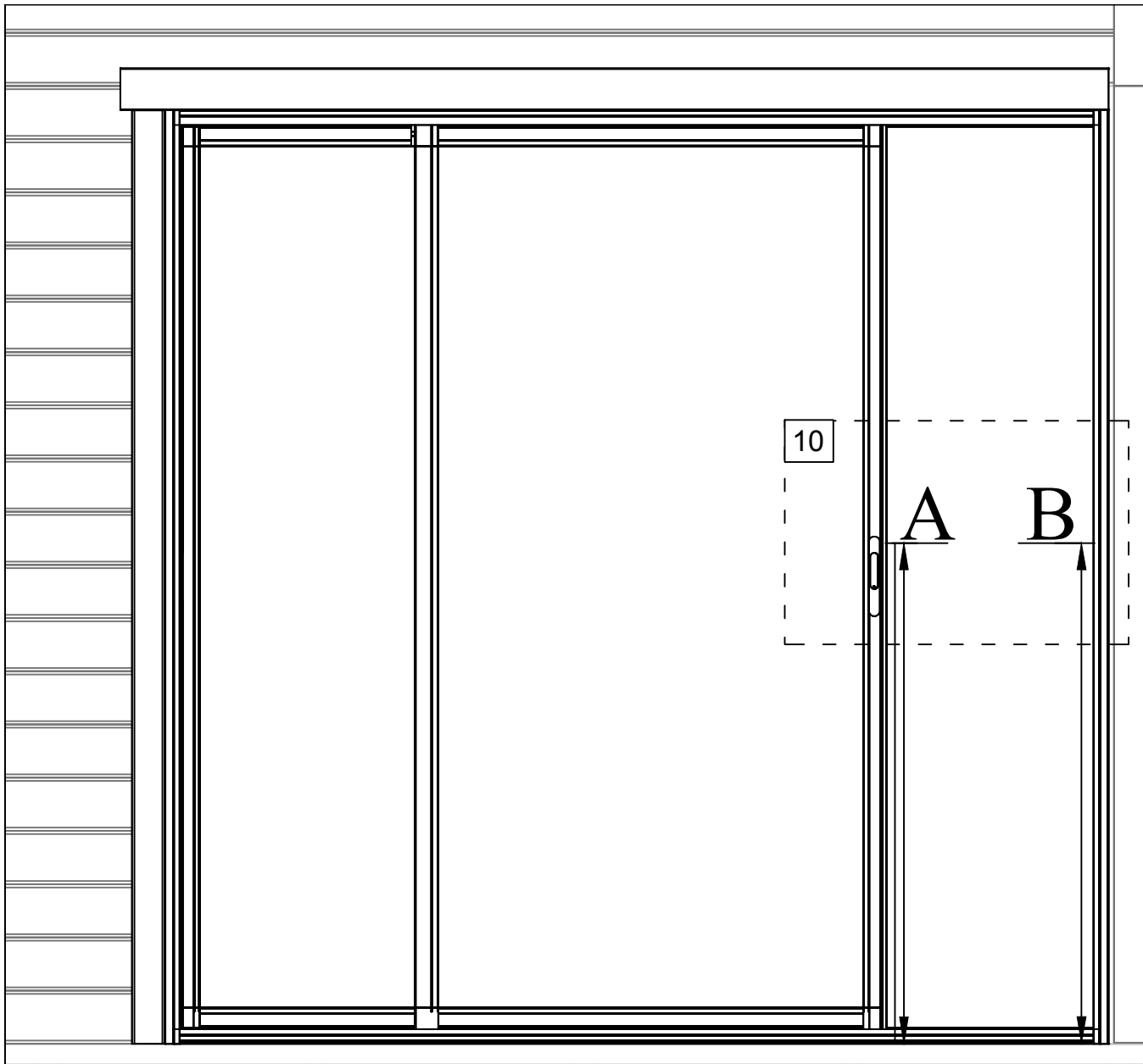

$$A=B$$

10

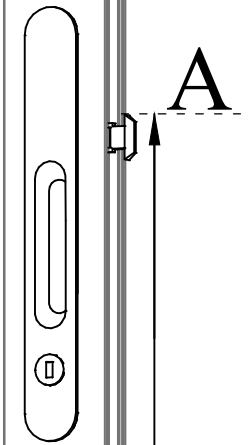

10

