

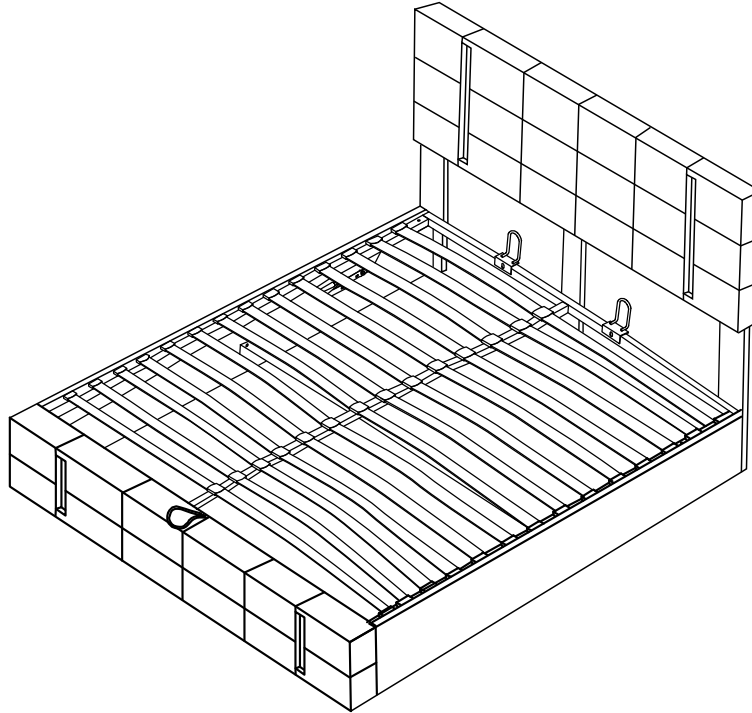

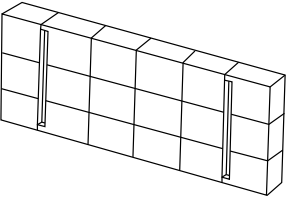







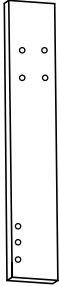
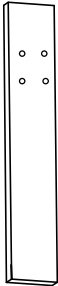
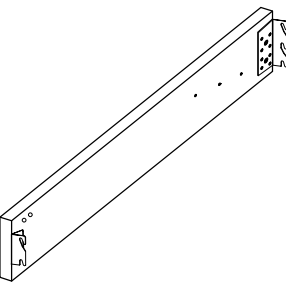
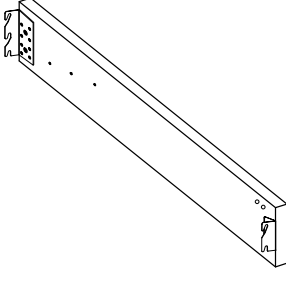
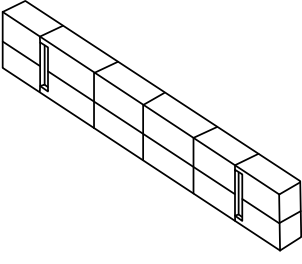
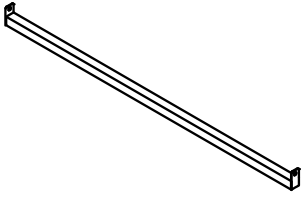
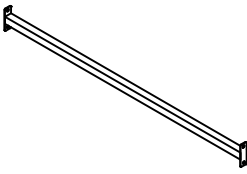
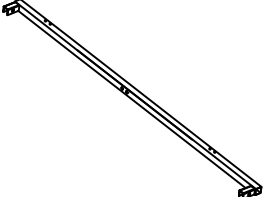
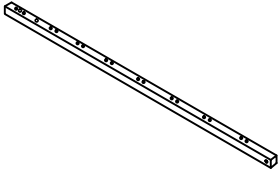
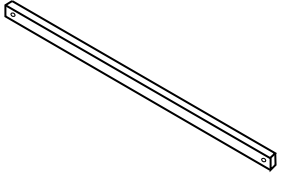

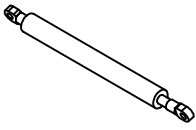
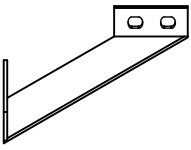
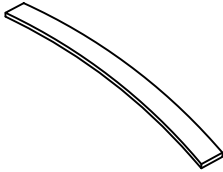
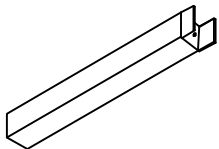

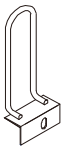
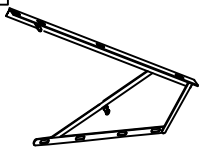
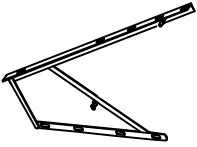

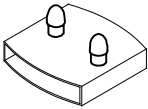
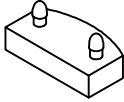
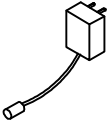
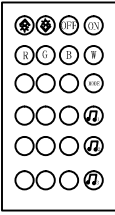
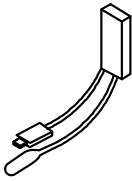

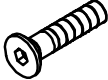
# Montageanleitung



## Teilleiste

<p><b>A</b></p>  <p>1PC</p>	<p><b>B</b></p>  <p>R 1PC</p>	<p><b>C</b></p>  <p>L 1PC</p>	<p><b>D</b></p>  <p>1PC</p>
<p><b>E</b></p>  <p>L 1PC</p>	<p><b>F</b></p>  <p>R 1PC</p>	<p><b>G</b></p>  <p>1PC</p>	<p><b>H</b></p>  <p>1PC</p>
<p><b>I</b></p>  <p>1PC</p>	<p><b>J</b></p>  <p>2PCS</p>	<p><b>K</b></p>  <p>2PCS</p>	<p><b>L</b></p>  <p>1PC</p>

# Teilleiste

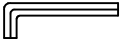
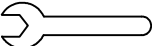
<p>M</p>  <p>2PCS</p>	<p>N</p>  <p>2PCS</p>	<p>O</p>  <p>24PCS</p>	<p>P</p>  <p>2PCS</p>	
<p>Q</p>  <p>2PCS</p>	<p>R</p>  <p>2PCS</p>	<p>S</p>  <p>L</p> <p>1PC</p>	<p>T</p>  <p>R</p> <p>1PC</p>	
<p>U</p>  <p>1PC</p>	<p>V</p>  <p>12PCS</p>	<p>W</p>  <p>24PCS</p>	<p>X</p>  <p>2PCS</p>	
<p>Y</p>  <p>1PC</p>	<p>Z</p>  <p>1PC</p>	<p>1</p>  <p>M8*50mm</p> <p>12PCS</p>	<p>2</p>  <p>M8*15mm</p> <p>8PCS</p>	
<p>3</p>  <p>M8*40mm</p> <p>6PCS</p>	<p>4</p>  <p>M8*25mm</p> <p>8PCS</p>	<p>5</p>  <p>M8*35mm</p> <p>2PCS</p>	<p>6</p>  <p>M6*25mm</p> <p>20PCS</p>	
<p>7</p>  <p>M6*15mm</p> <p>2PCS</p>	<p>8</p>  <p>M8</p> <p>4PCS</p>	<p>9</p>  <p>M8 Blocking nut</p> <p>4PCS</p>	<p>10</p>  <p>Ø19</p> <p>40PCS</p>	<p>11</p>  <p>Ø14</p> <p>22PCS</p>
<p>12</p>  <p>M4</p> <p>1PC</p>	<p>13</p>  <p>M5</p> <p>1PC</p>	<p>14</p>  <p>M8</p> <p>1PC</p>		

## Teileliste

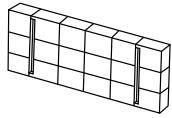

A. 1PC



R  
B. 1PC



L  
C. 1PC



D. 1PC



H. 1PC

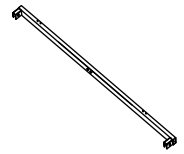

L. 2PCS

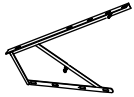

L  
S. 1PC



R  
T. 1PC

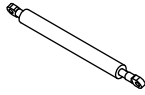

M. 2PCS



W. 24PCS



V. 12PCS



O. 24PCS

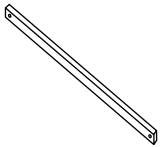

L. 1PC

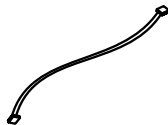

Q. 2PCS

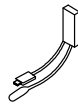

Z. 1PC

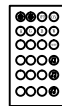

Y. 1PC

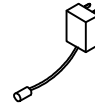

X. 2PCS



U. 1PC

## Teileliste

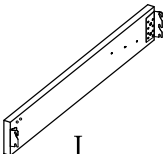

L  
E. 1PC

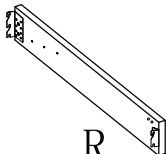

R  
F. 1PC

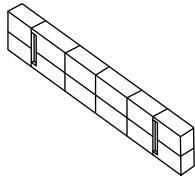

G. 1PC

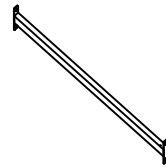

I. 1PC

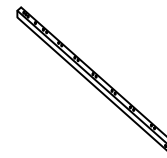

K. 2PCS



M8\*15mm  
2. 8PCS



M8\*40mm  
3. 6PCS



M8\*25mm  
4. 8PCS



M8\*35mm  
5. 2PCS



M6\*25mm  
6. 20PCS



M6\*15mm  
7. 2PCS



M8  
8. 4PCS



M8\*50mm  
1. 12PCS



M8  
Blocking nut  
9. 4PC



Ø19  
10. 40PCS



Ø14  
11. 22PCS

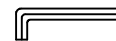

M4  
12. 1PC

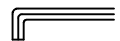

M5  
13. 1PC

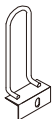

R. 2PCS

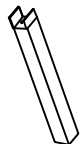

P. 2PCS

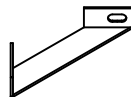



N. 2PCS

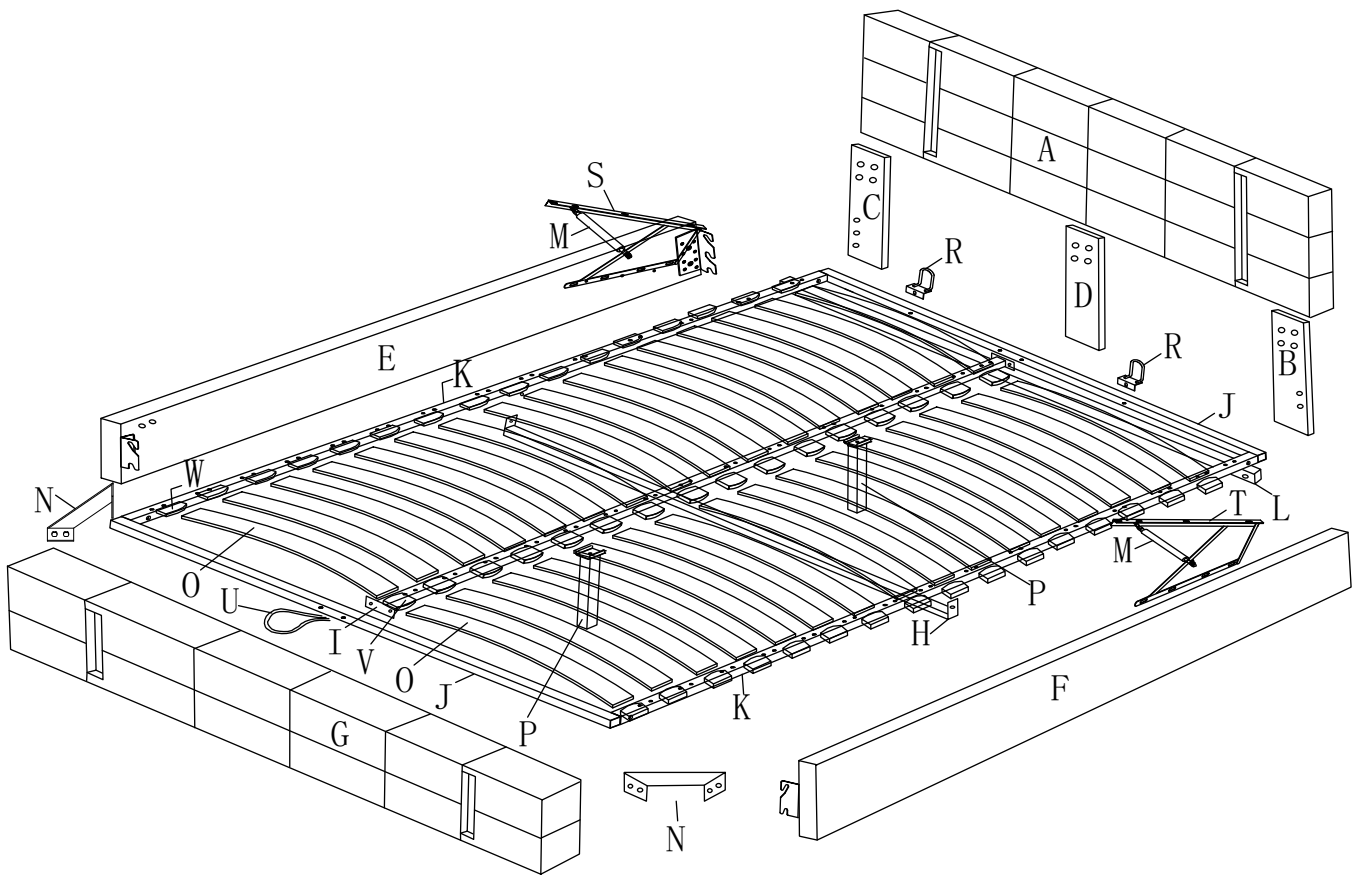

M12  
14. 1PC







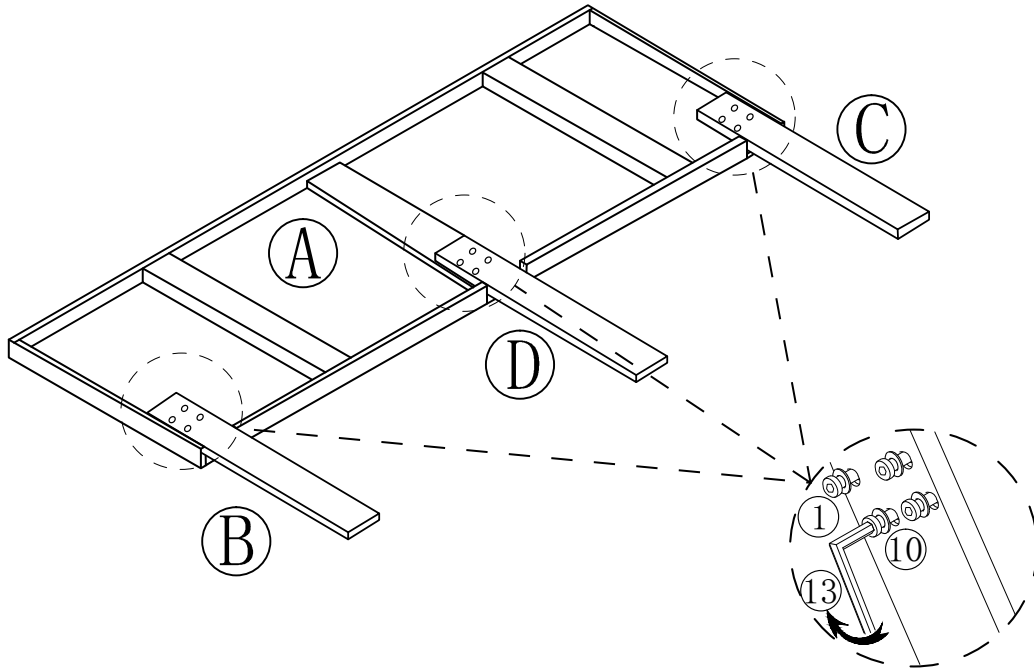

# SCHRITT 1

1	 M8*50MM	10	 Ø19	13	 M5
	12PCS		12PCS		1PC





# SCHRITT 2

4	 M8*25	7	 M6*15	10	 Ø19	11	 Ø14	12	 M4	13	 M5
	8PCS		2PCS		10PCS		2PCS		1PC		1PC

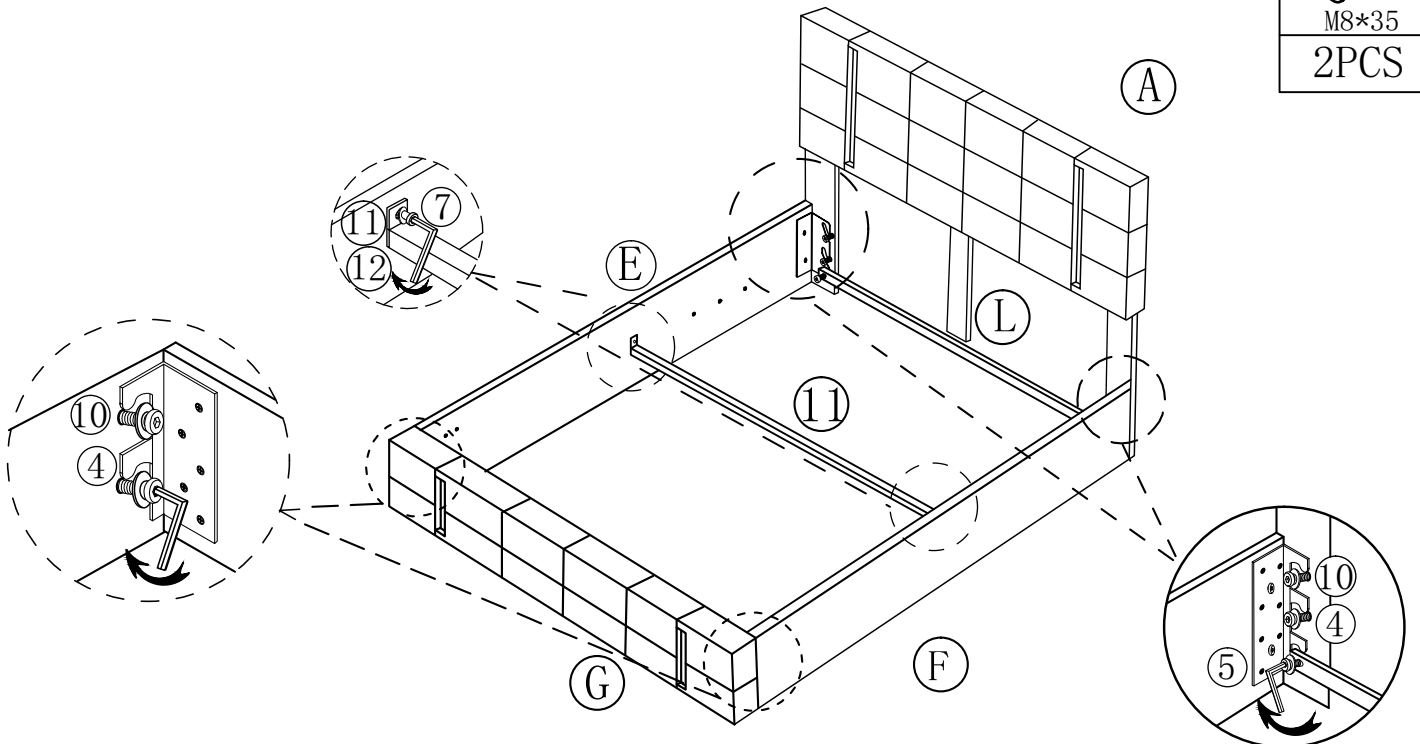
5	 M8*35
	2PCS



# SCHRITT 3



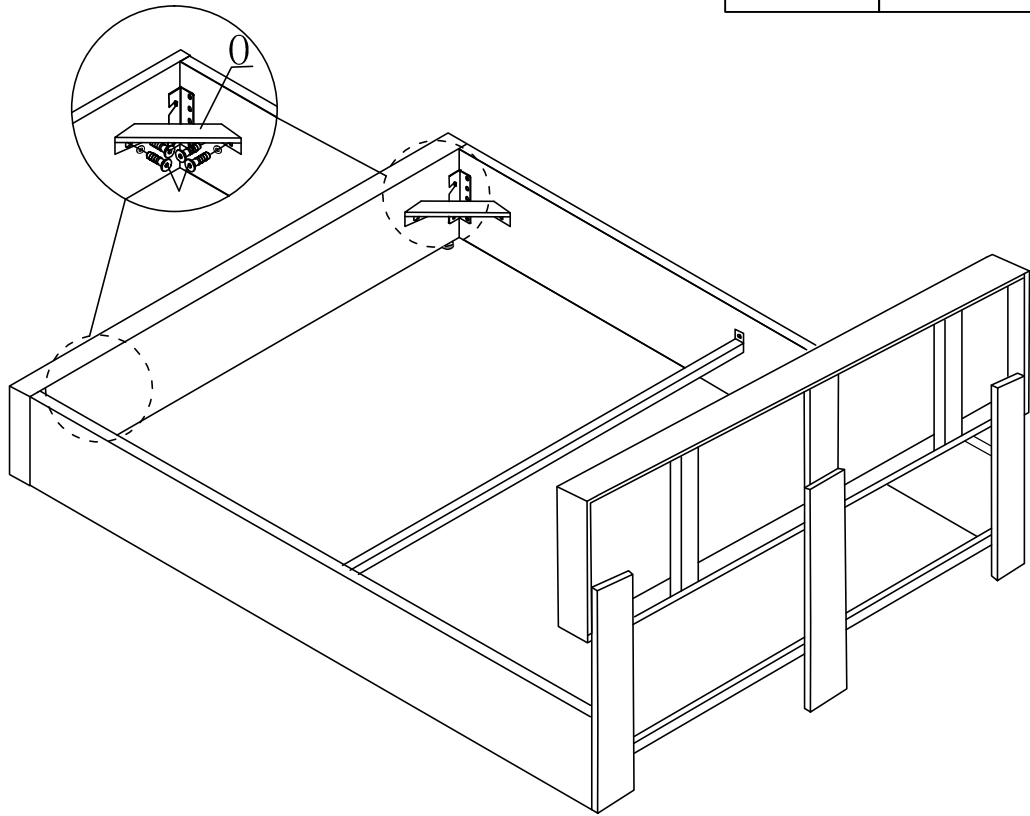

2		10		13	
	M8*15		Ø19		M5
	8PCS		8PCS		1PC

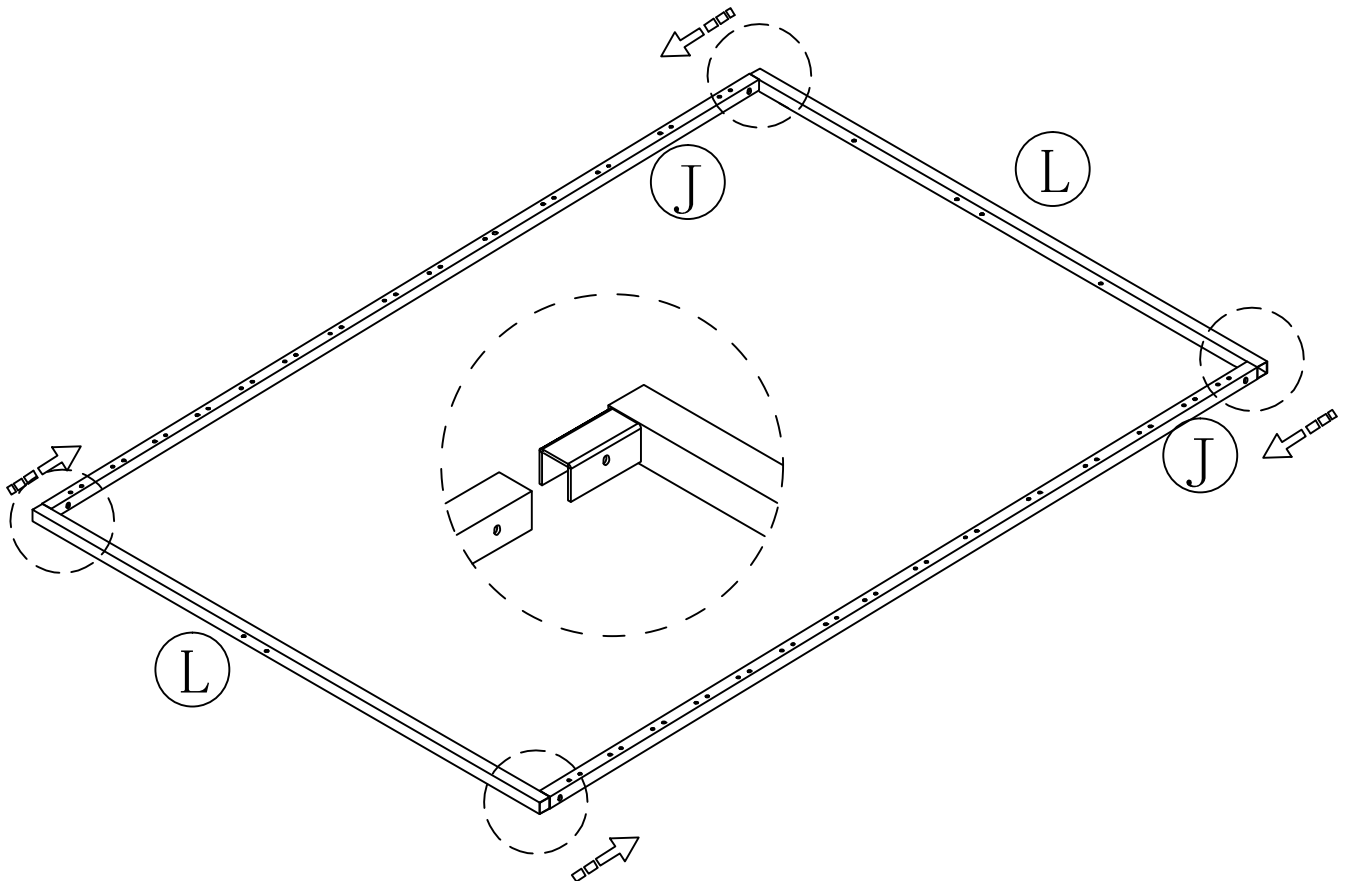

# SCHRITT 4



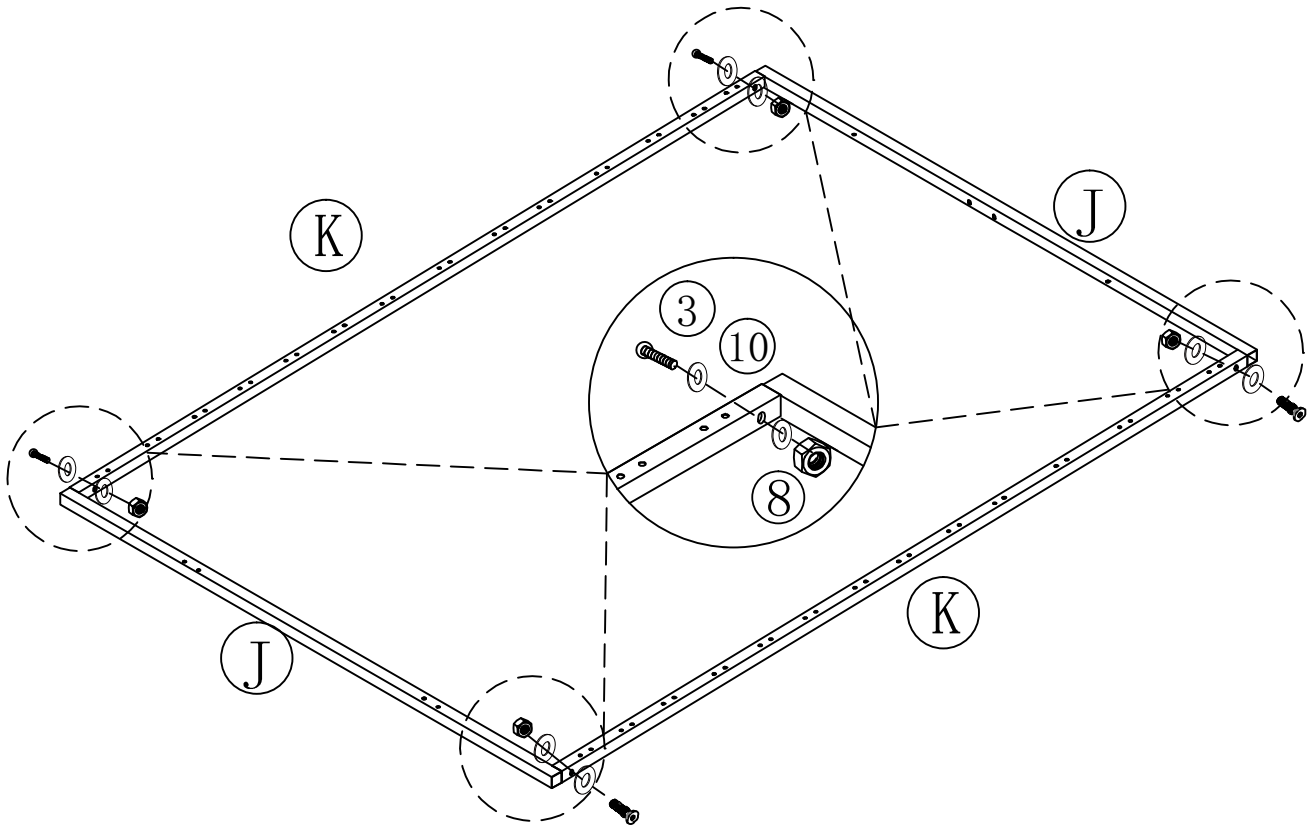

# SCHRITT 5

3		10		8		13		14	
	M8*40		Ø19		M8		M5		
	4PCS		8PCS		4PCS		1PC		1PC



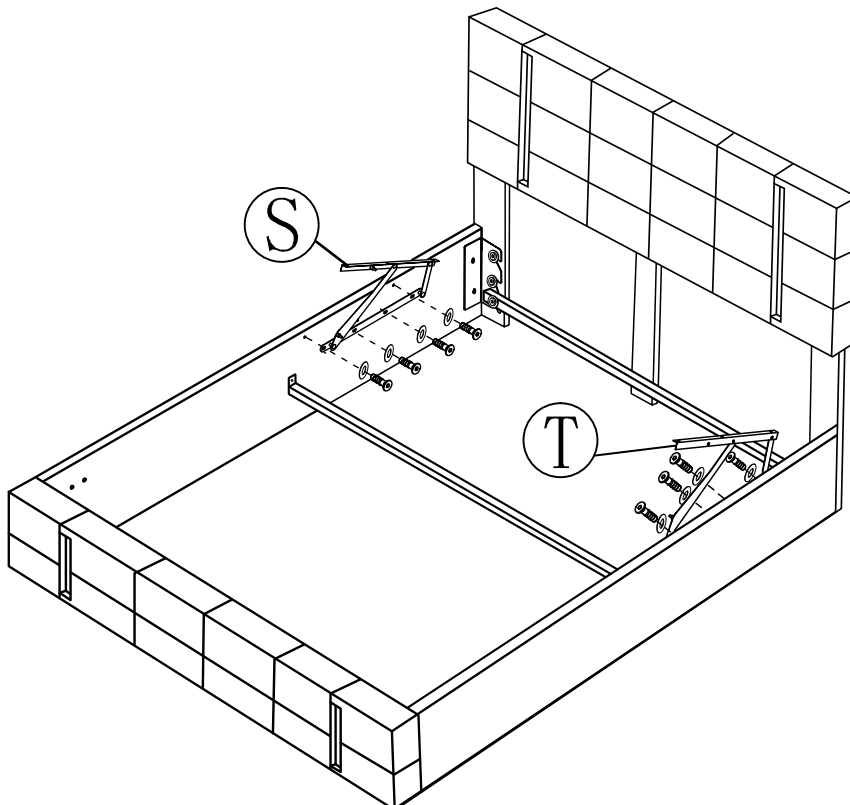

# SCHRITT 6

6		11		12	
	M6*25		Ø14		M4
	8PCS		8PCS		1PC



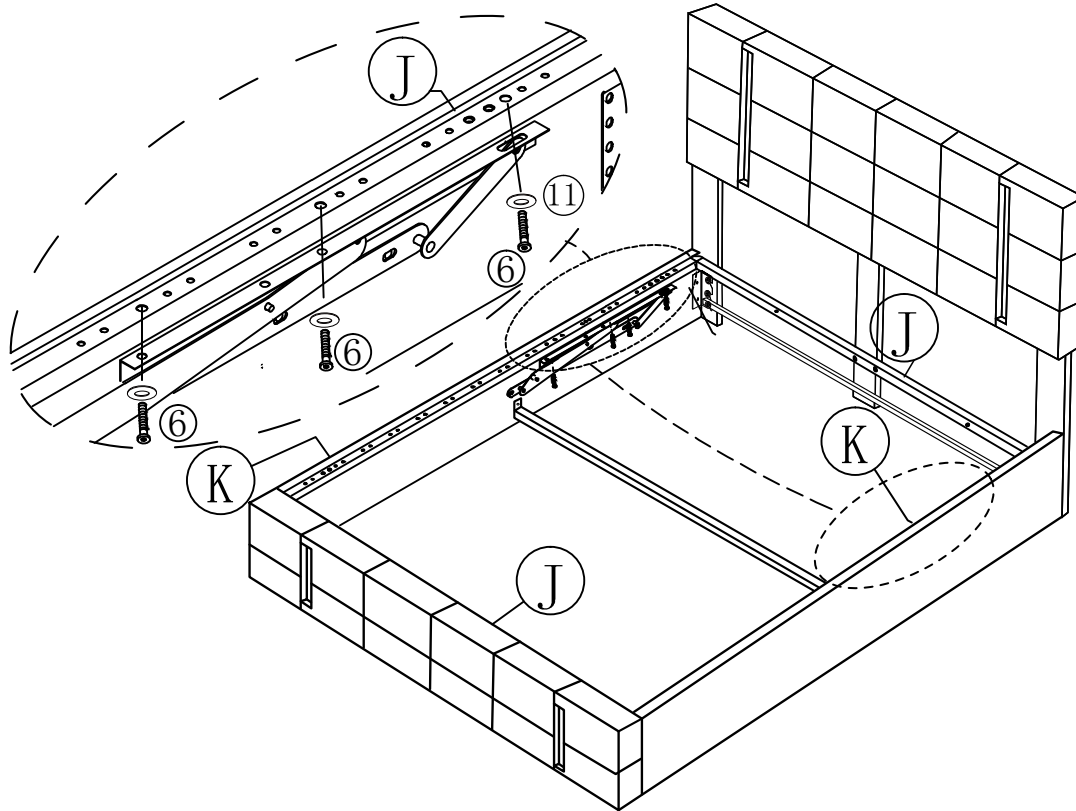

# SCHRITT 7

6		11		12	
	M6*25		Ø14		M4
	6PCS		6PCS		1PC







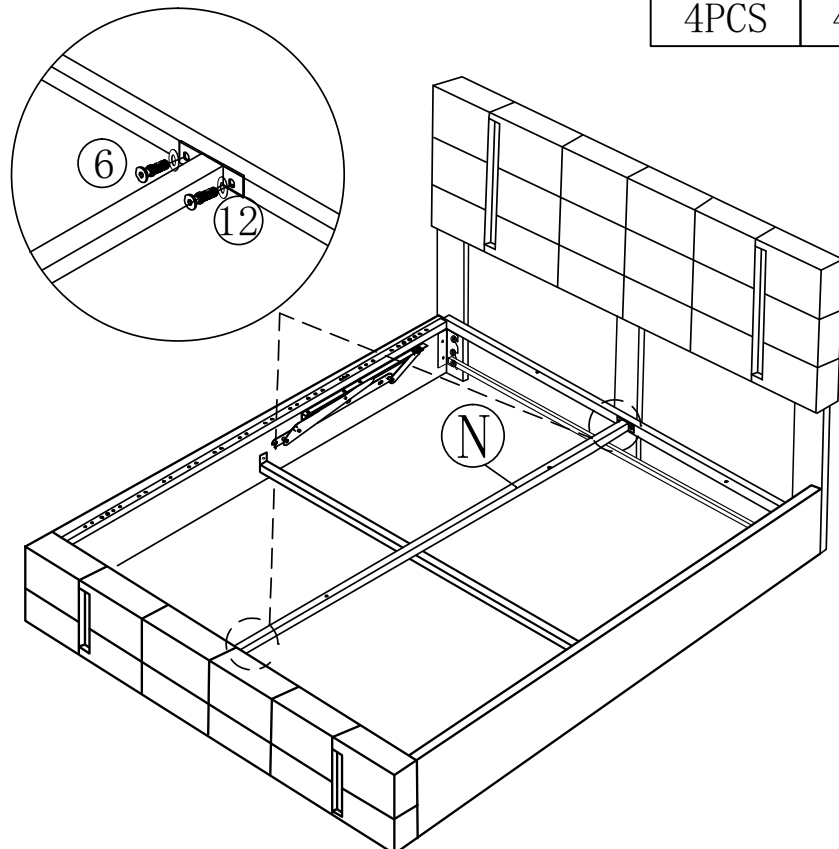

# SCHRITT 8

6		11		12	
	M6*25		Ø14		M4
	4PCS		4PCS		1PC





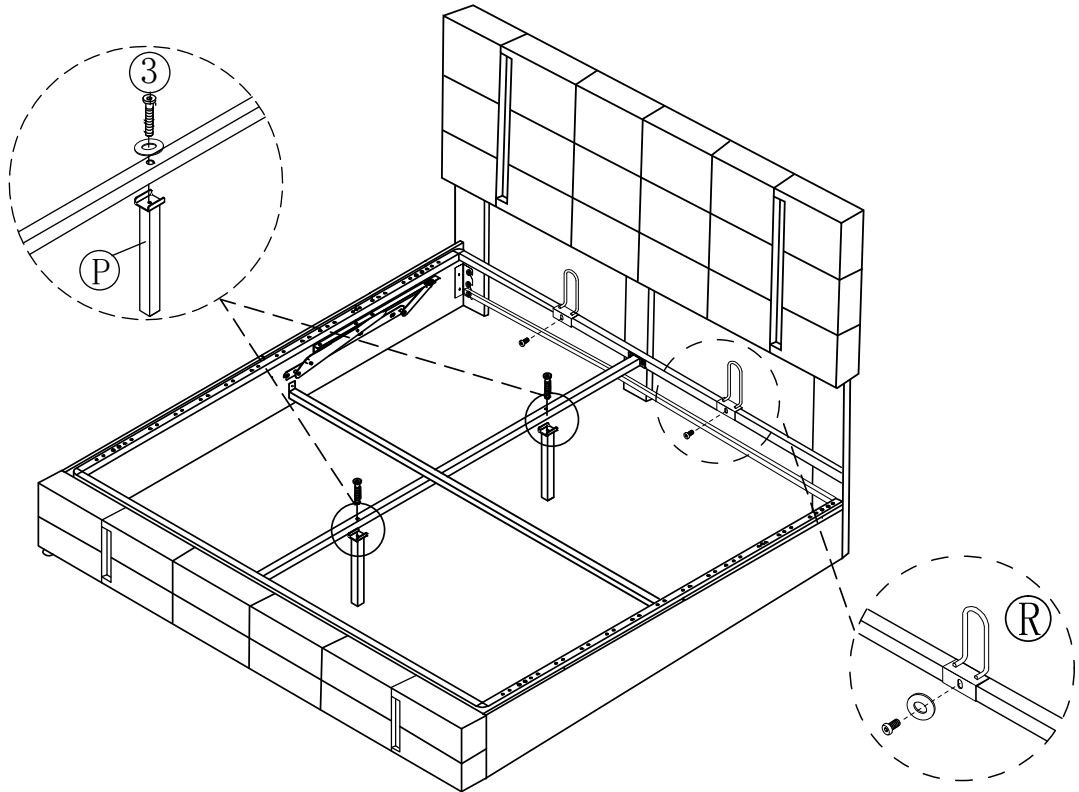

# SCHRITT 9

3		6		10		11		12		13	
	M8*40		M6*25		Ø19		Ø14		M4		M5
	2PCS		2PCS		2PCS		2PCS		1PC		1PC



# SCHRITT 10

9		14	
	Blocking nut M8		
	4PCS		1PC

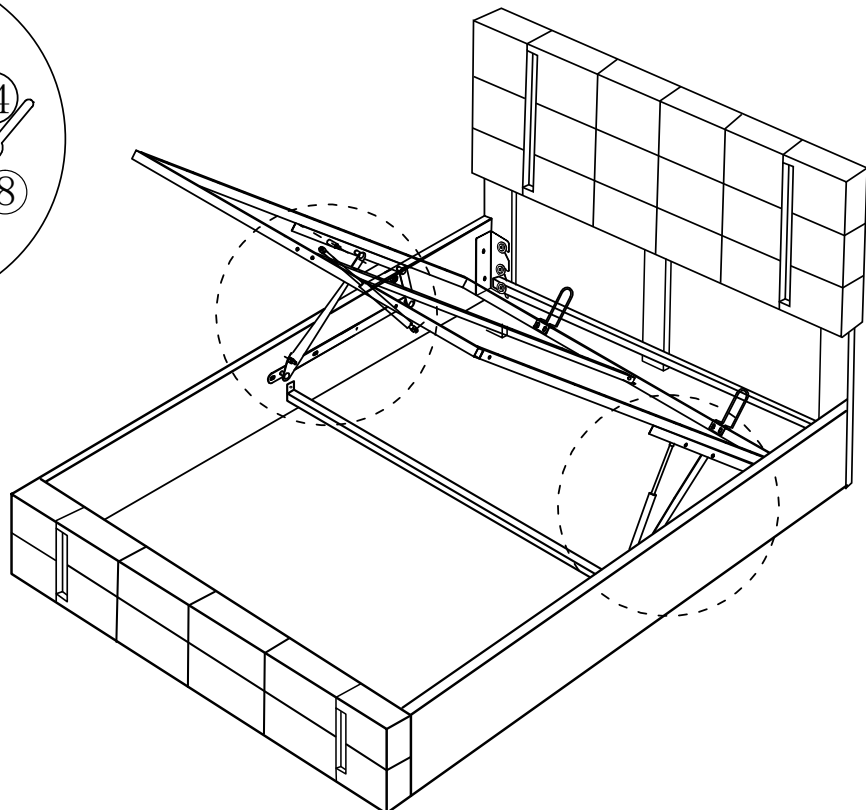
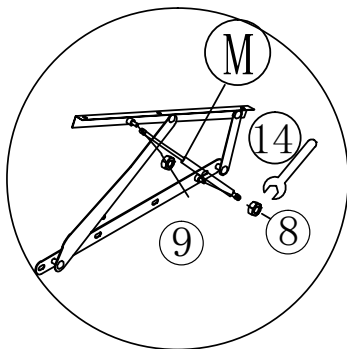

# SCHRITT 11

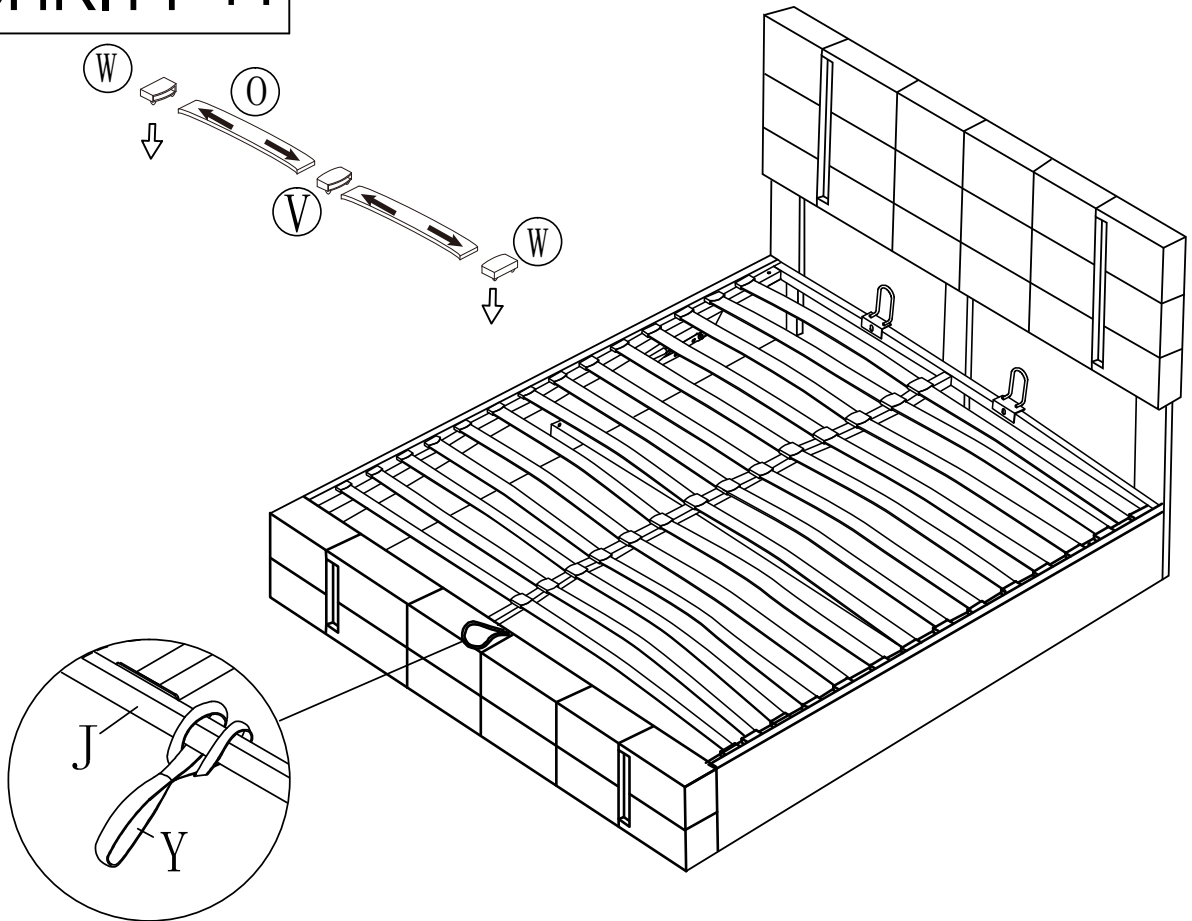

# SCHRITT 12

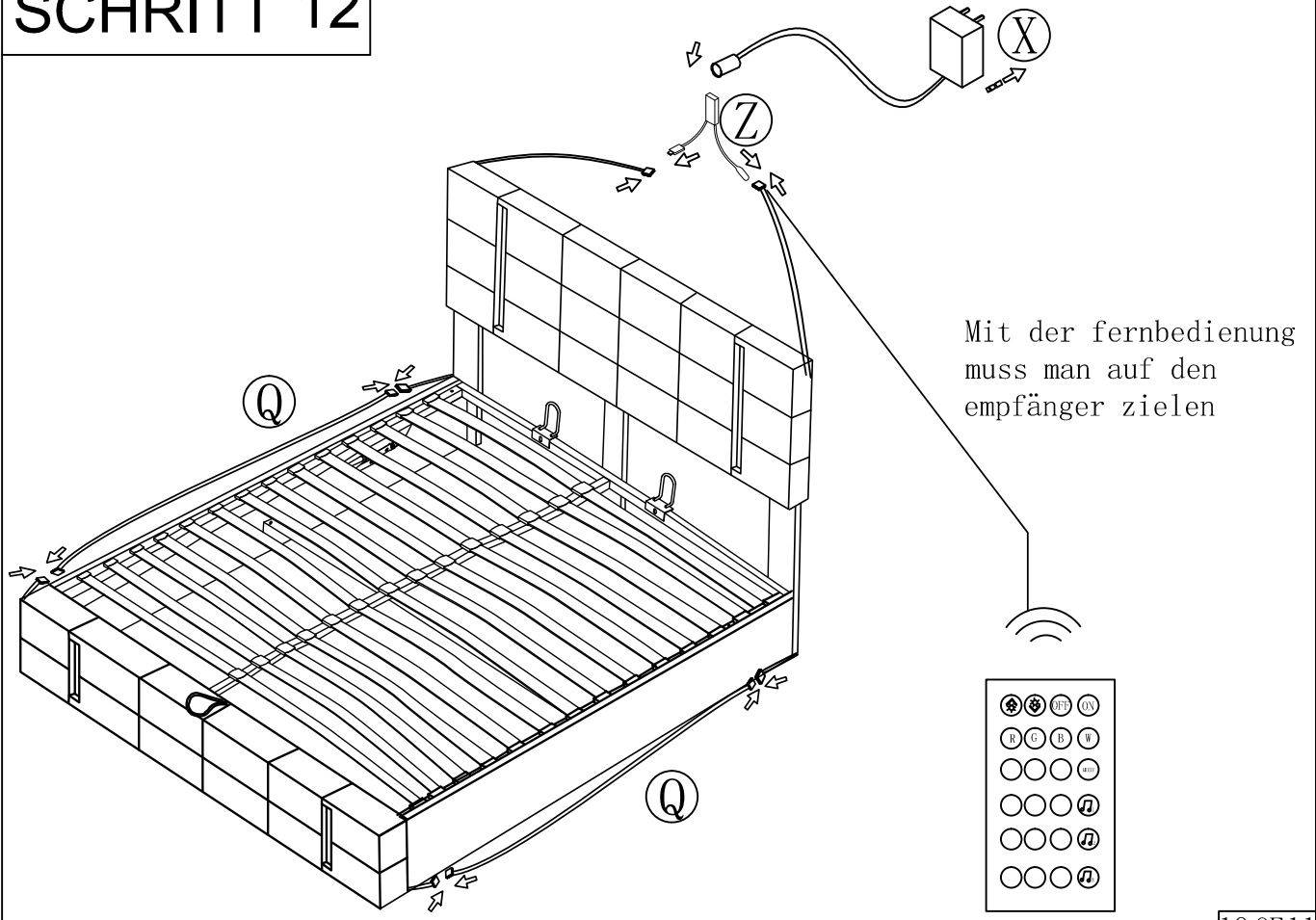

# SCHRITT 13

