

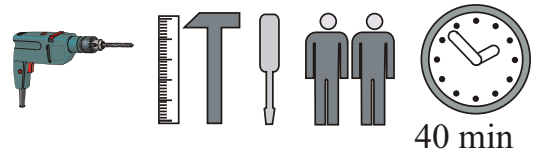

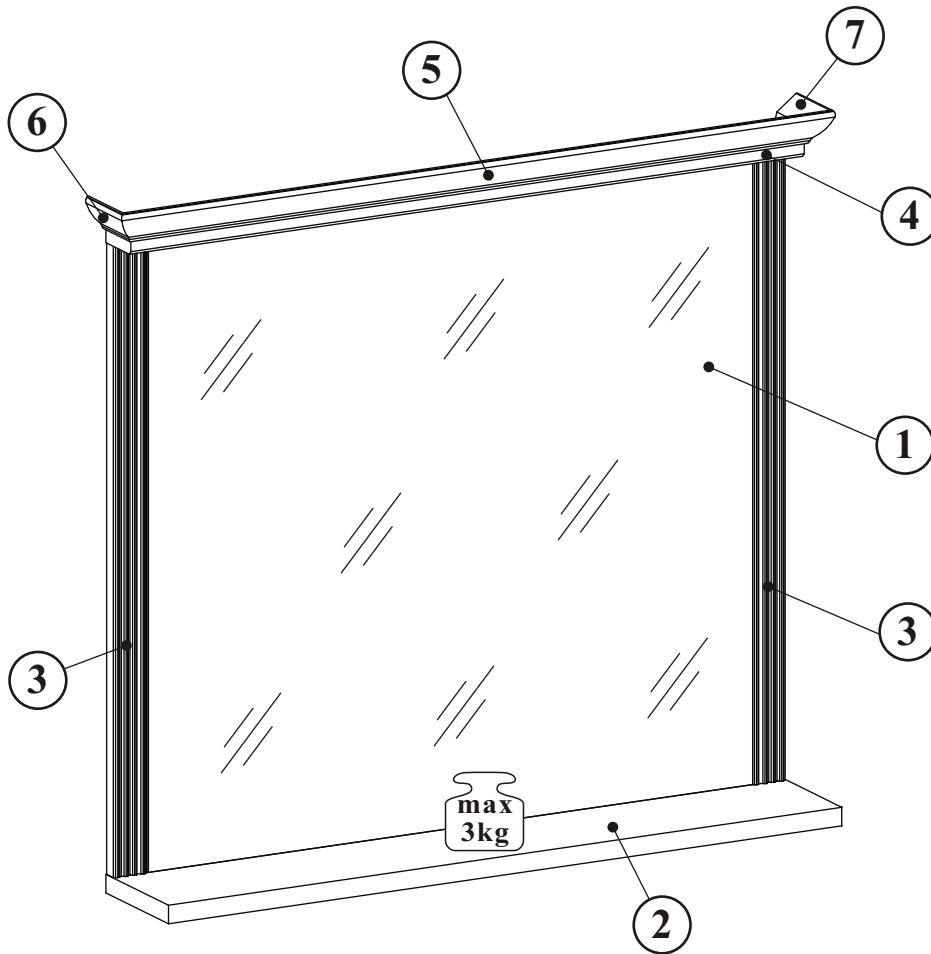

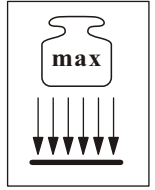



JASMIN 30B1_51

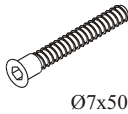

NO	Dim.		Col.-No	Qty
1	750	788	1	1
2	876	150	1	1
3	750	43	1	2
4	876	60	1	1
5	929	67	1	1
6	86	67	1	1
7	86	67	1	1

A1 x8  ø8x36	A3 x4  ø8x47	B5 x12  ø15x12	G5 x12 	B9 x6  ø7x48	D9 x7  USØ3x20
B11 x10  ø7x50	G4 x10 	D20 x6  ESØ6,3x9,5	KR2 x3 	G2 x1 	

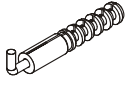
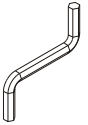
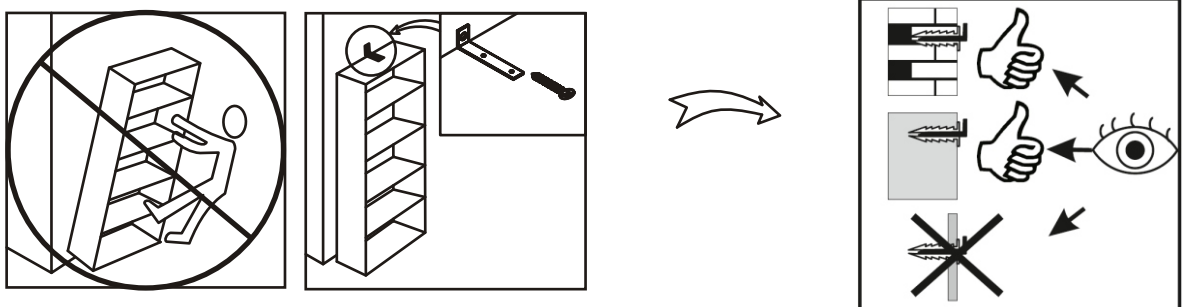
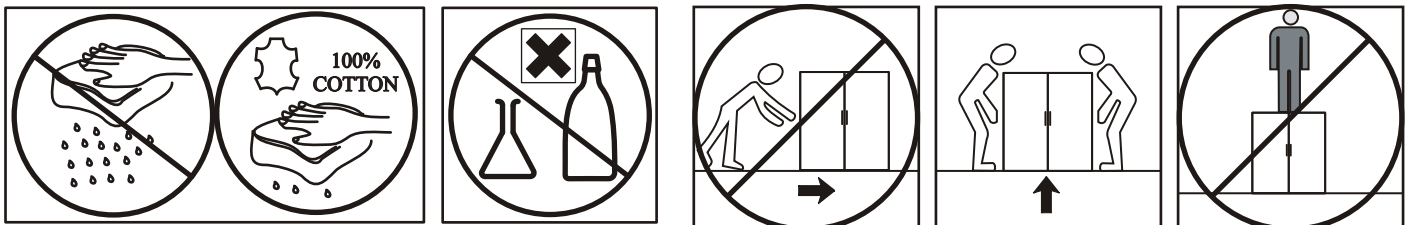
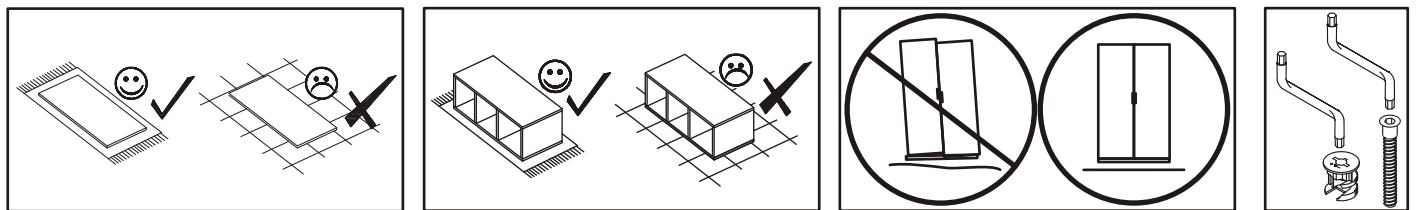
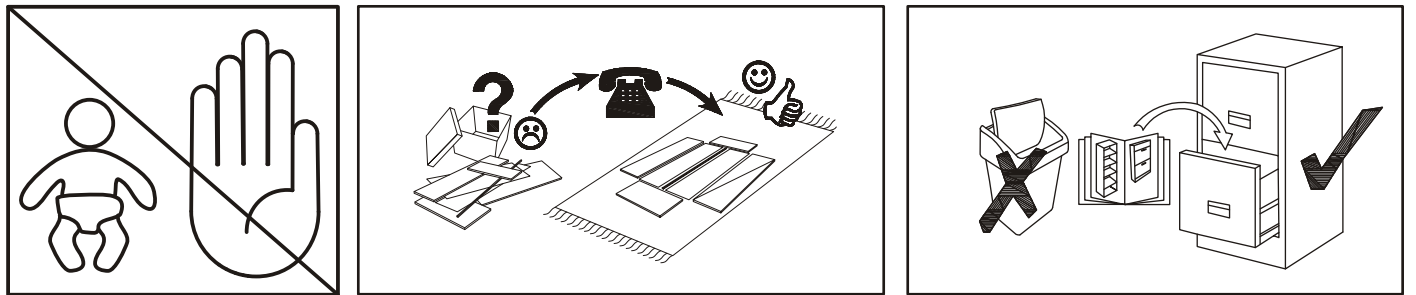
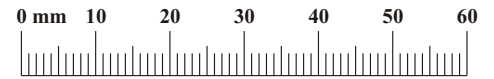

1

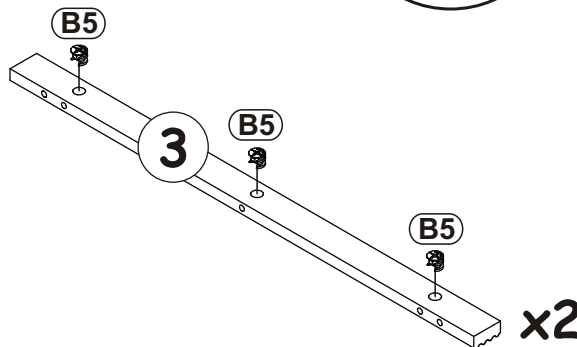
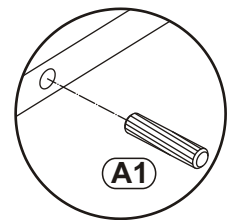
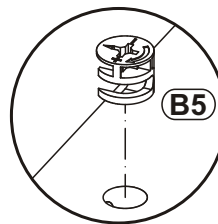
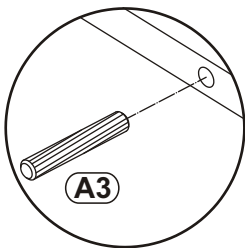
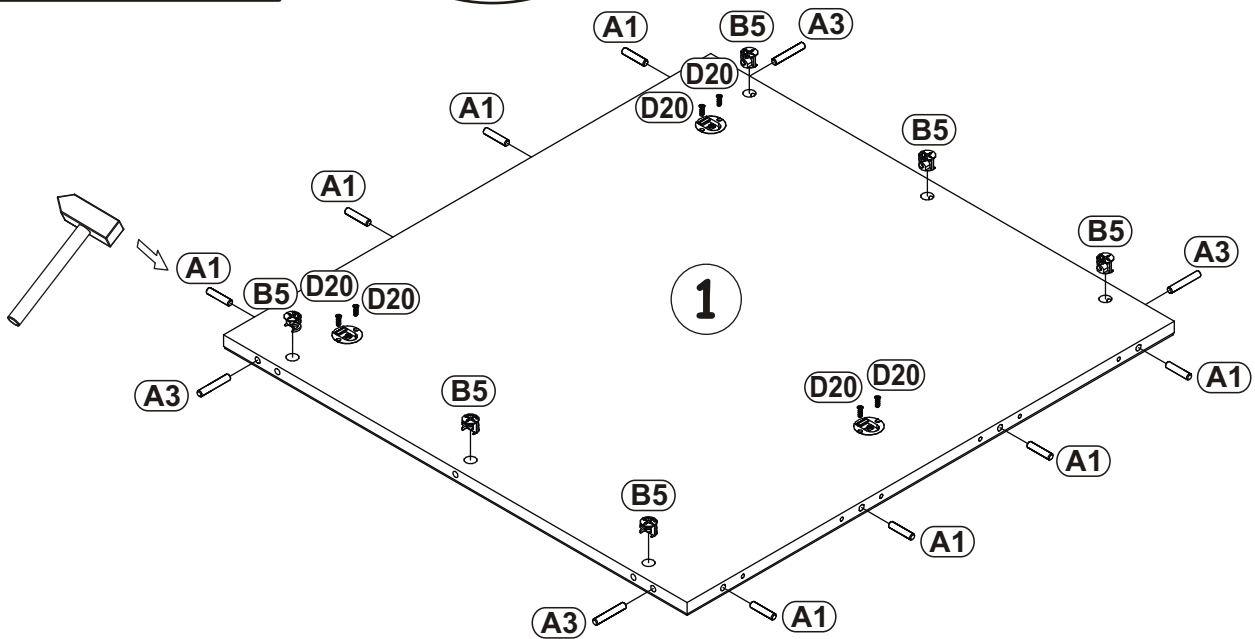
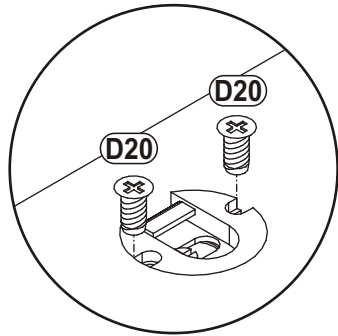
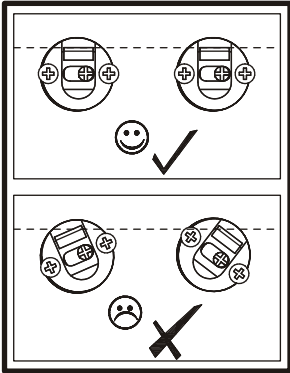
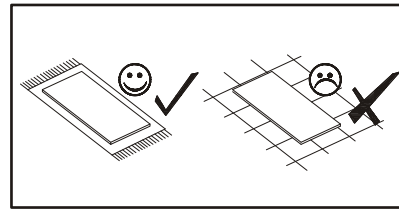
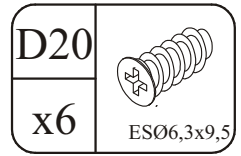
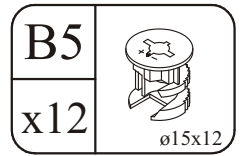
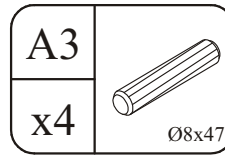
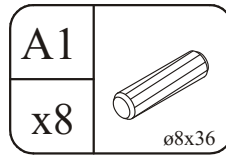

B9		G5	
x6	Ø7x48	x12	

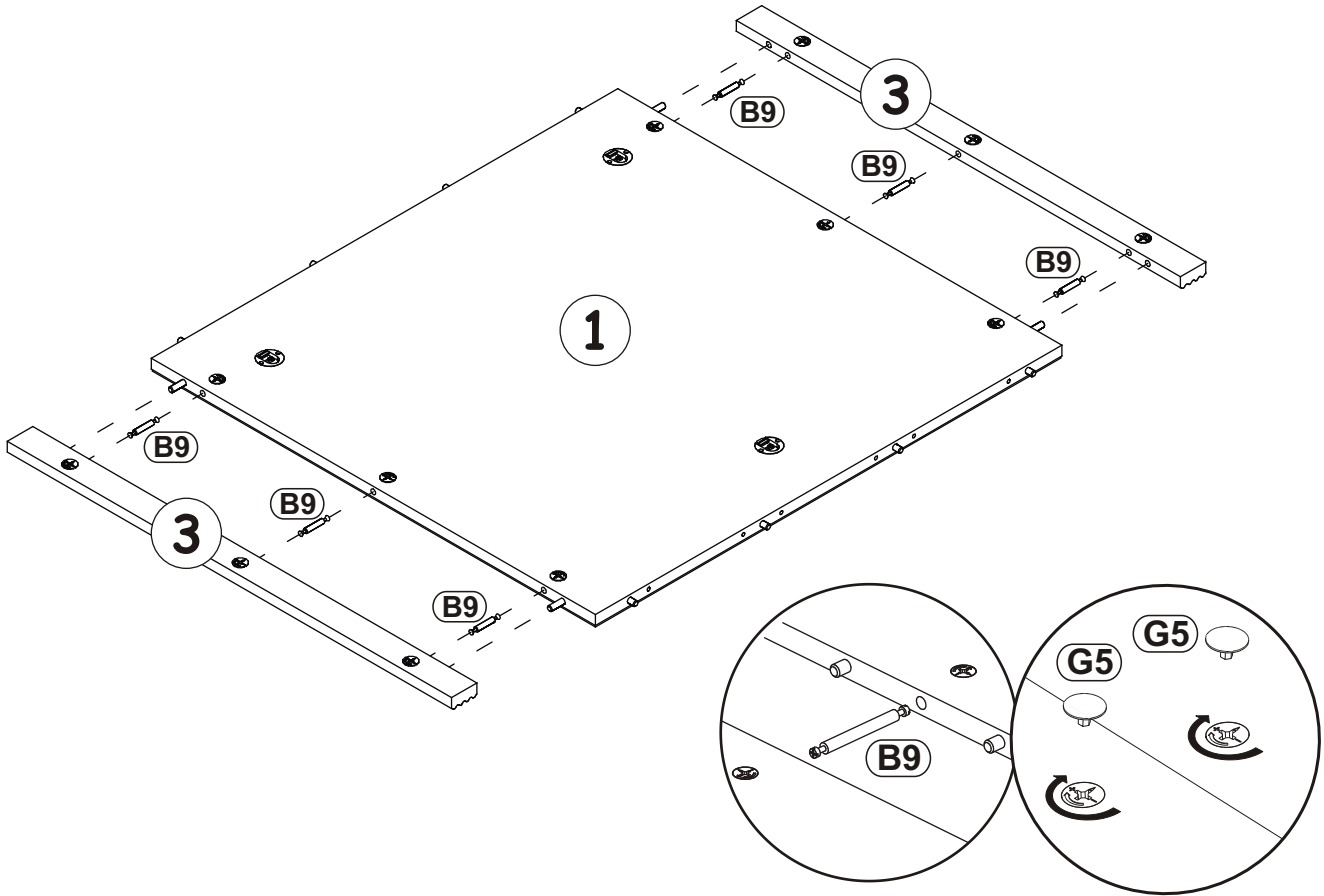

2

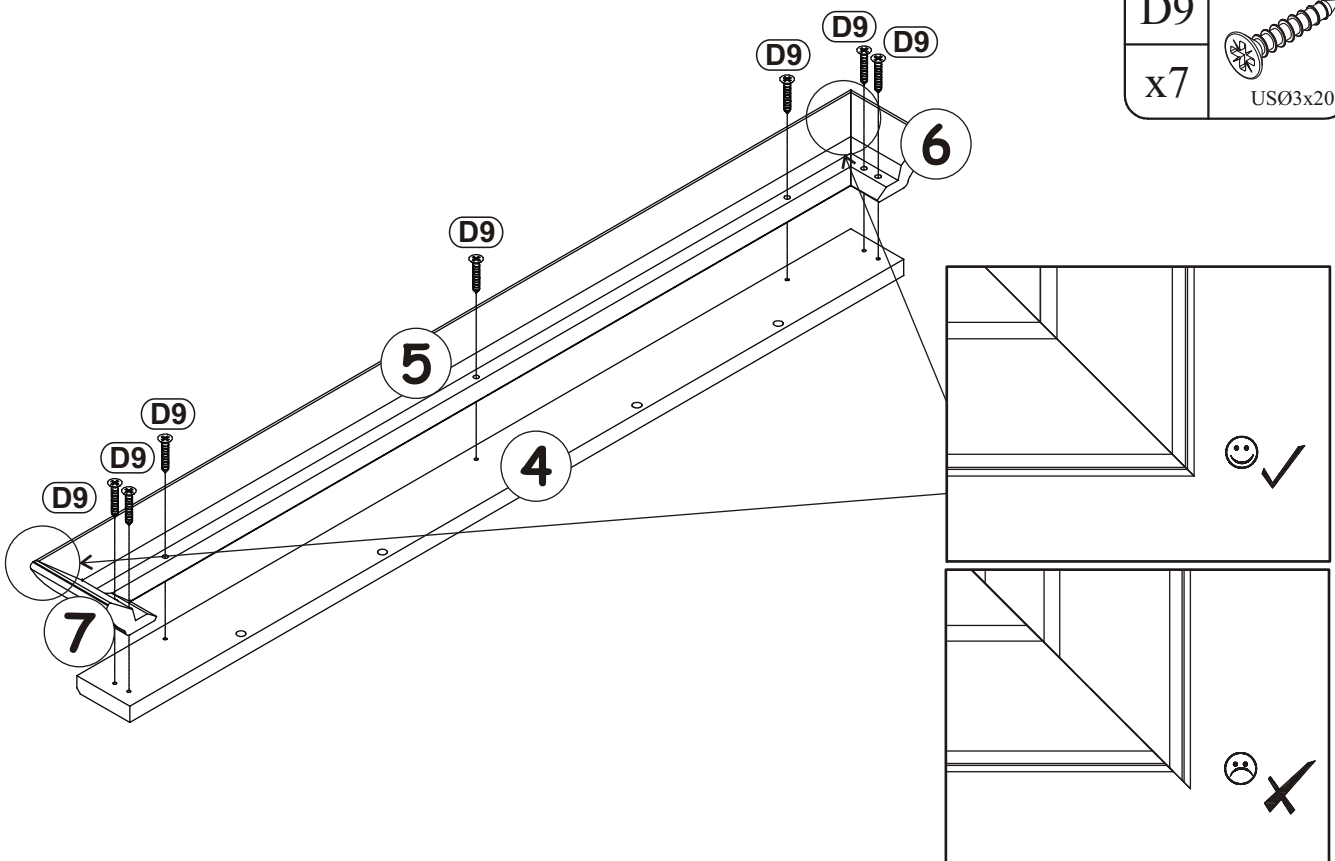

3

D9	
x7	USØ3x20



B11	 Ø7x50	G4	
x10		x10	

4

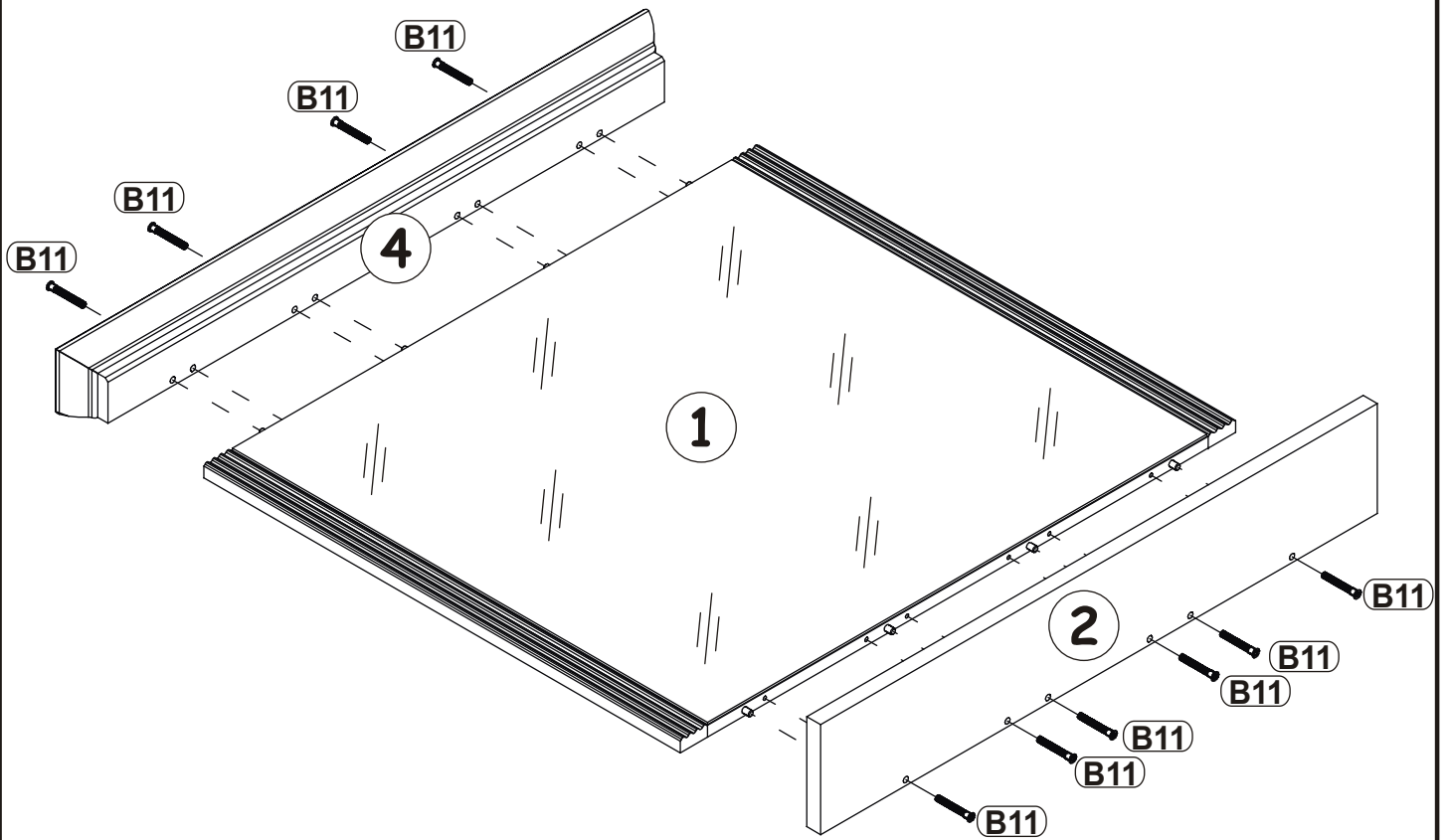
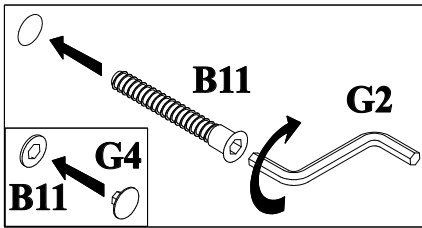

KR2
x3

5

