



(D) Videounterstützte Montageanleitung

(TR) Video destekli kurulum talimatları

(RU) инструкция по монтажу с помощью видеосигнала

(RO) Instrucțiuni de instalare acceptate video

(GB) Video-assisted assembly instructions

(IT) Istruzioni di montaggio video-assistite

(CZ) Instalační pokyny podporované videem

(PL) Instrukcje montażu wspomagane sygnałem wizyjnym

(FR) Instructions de montage assistées par vidéo

(NL) Video-ondersteunde montage-instructies

(HU) Video-támogatott telepítési utasítások

(SK) Inštaláčn  pokyny podporované videom

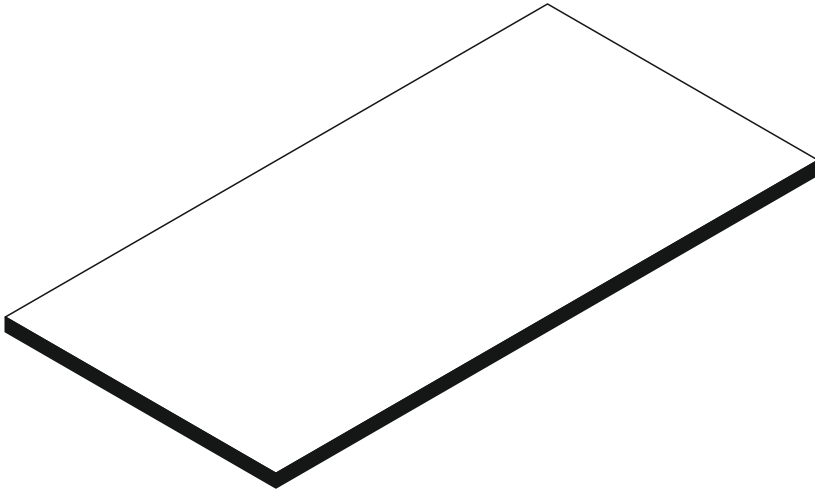
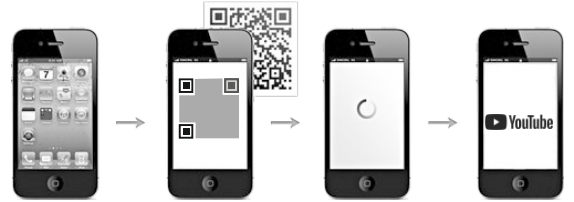

0546_180-90 P1 Tischplatte

REPC-Nr.:

Service • Assistenza • Dienstverlening • Serwis
Servis • Szerviz • Сервисная служба

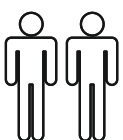
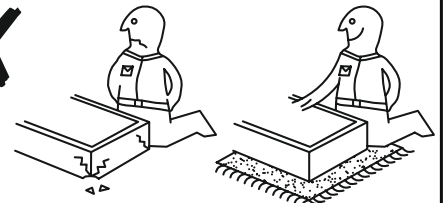
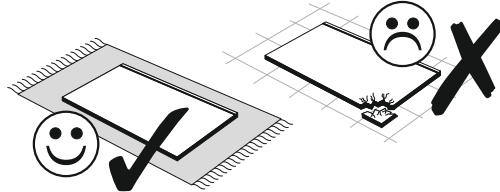
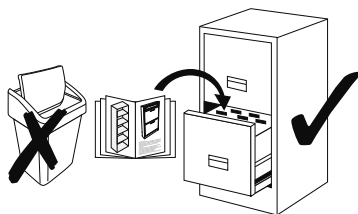
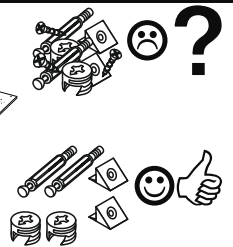
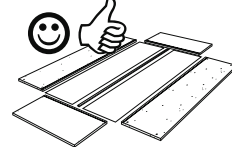
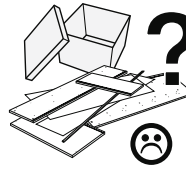
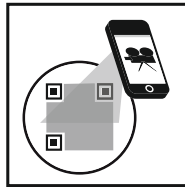
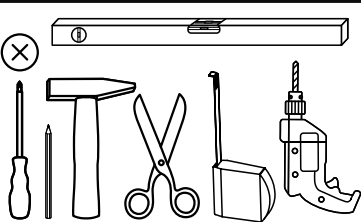

Das Ersatzteil-Anforderungsformular finden Sie auf <https://www.maeusbacher.de/ersatzteile/>

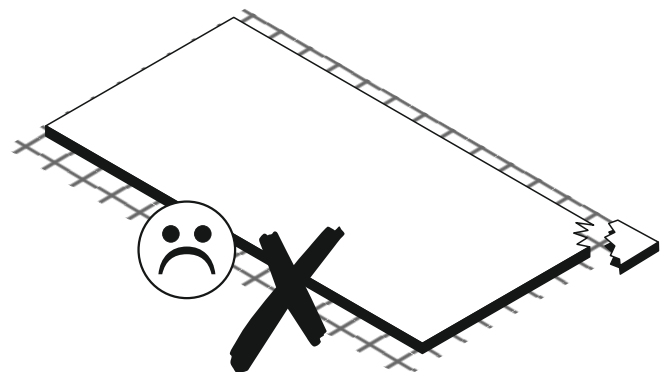
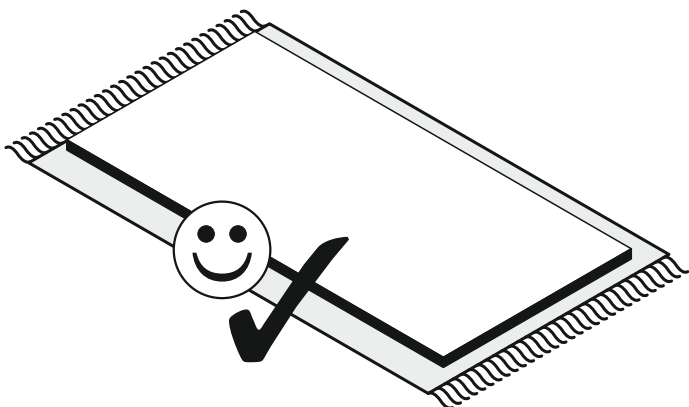
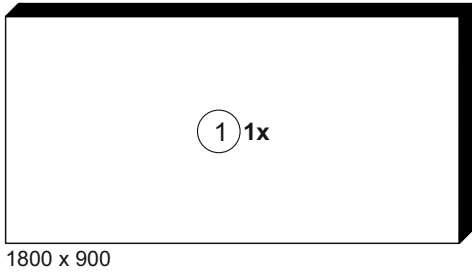
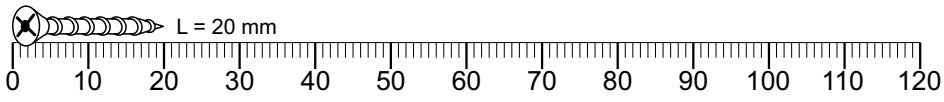
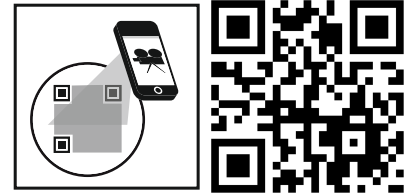



- | | | |
|---|--|--|
| (D) Videounterstützte Montageanleitung | (GB) Video-assisted assembly instructions | (FR) Instructions de montage assistées par vidéo |
| (TR) Video destekli kurulum talimatları | (IT) Istruzioni di montaggio video-assistite | (NL) Video-ondersteunde montage-instructies |
| (RU) инструкция по монтажу с помощью видеосигнала | (CZ) Instalační pokyny podporované videem | (HU) Video-támogatott telepítési utasítások |
| (RO) Instrucțiuni de instalare acceptate video | (PL) Instrukcje montażu wspomagane sygnałem wizyjnym | (SK) Inštaláčn  pokyny podporované videom |

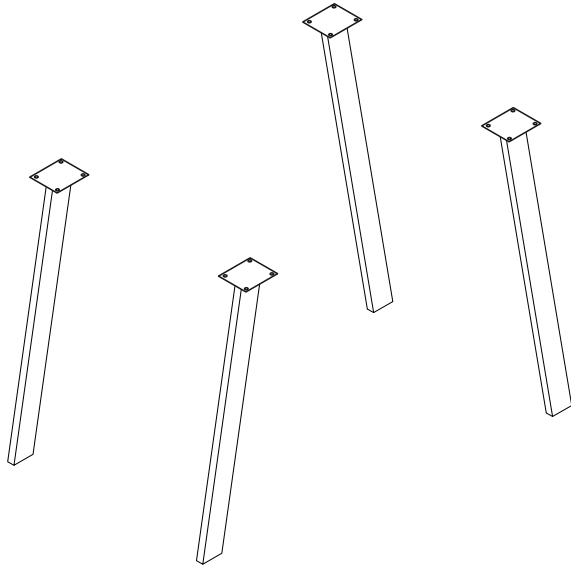

0212_Eckig-72 P2 Tischbeinset

REPC-Nr.:

Service • Assistenza • Dienstverlening • Servis
Servis • Szerviz • Сервисная служба

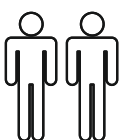
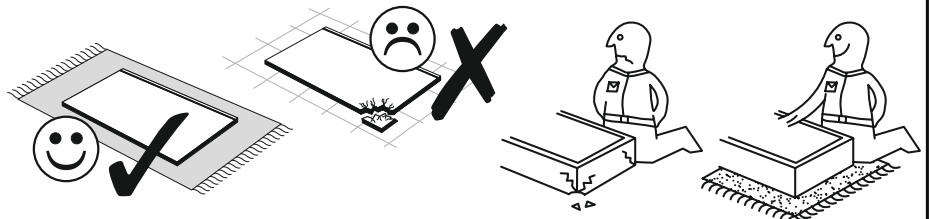
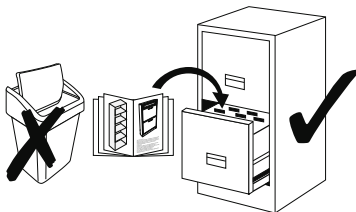
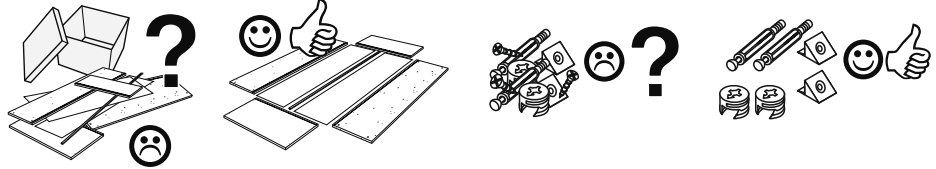
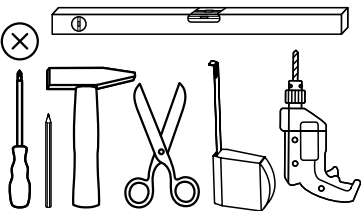

Das Ersatzteil-Anforderungsformular finden Sie auf <https://www.maeusbacher.de/ersatzteile/>

Beutel 1/1

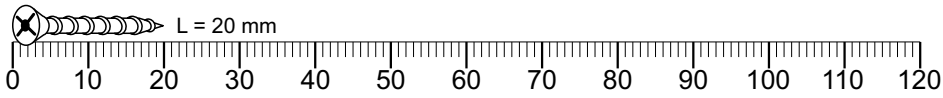
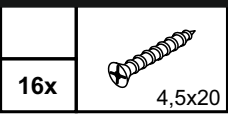

Colli 1/1

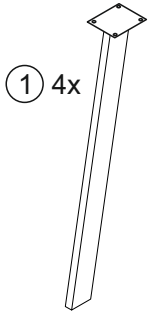

Höhe 720 mm

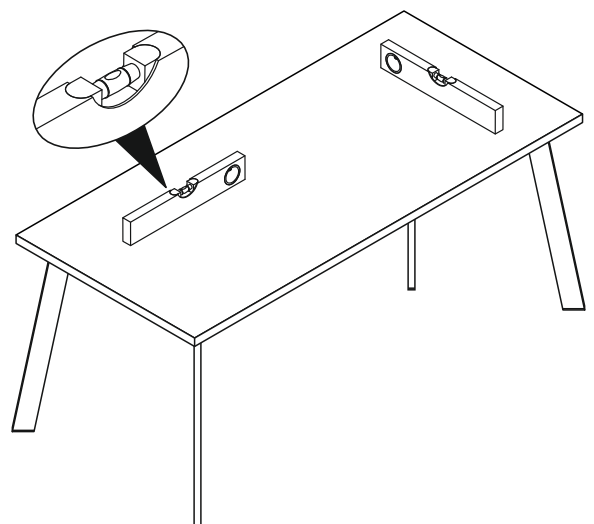
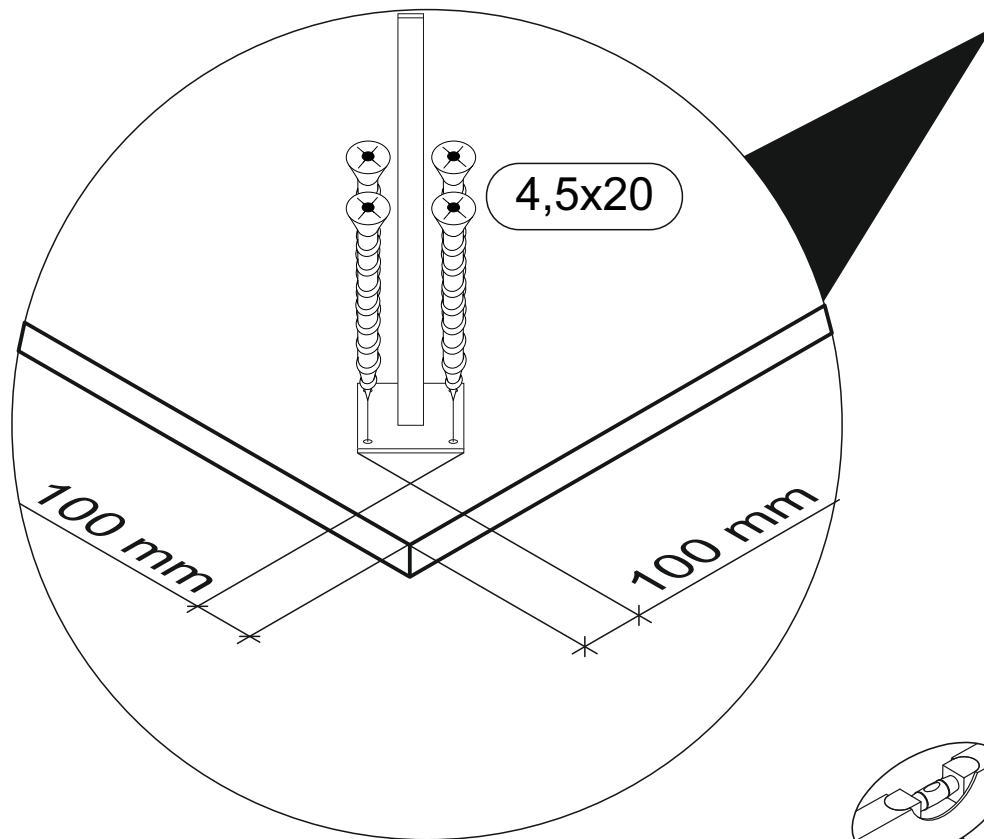
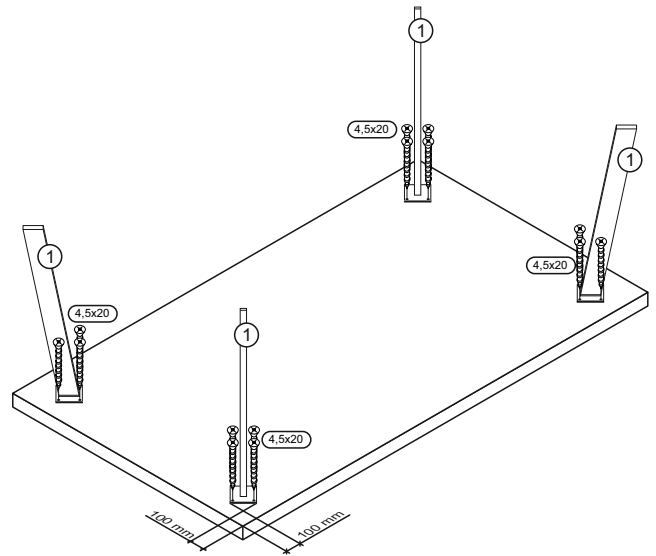



(D) Videounterstützte Montageanleitung

(TR) Video destekli kurulum talimatları

(RU) инструкция по монтажу с помощью видеосигнала

(RO) Instrucțiuni de instalare acceptate video

(GB) Video-assisted assembly instructions

(IT) Istruzioni di montaggio video-assistite

(CZ) Instalační pokyny podporované videem

(PL) Instrukcje montażu wspomagane sygnałem wizyjnym

(FR) Instructions de montage assistées par vidéo

(NL) Video-ondersteunde montage-instructies

(HU) Video-támogatott telepítési utasítások

(SK) Inštaláčn  pokyny podporované videom

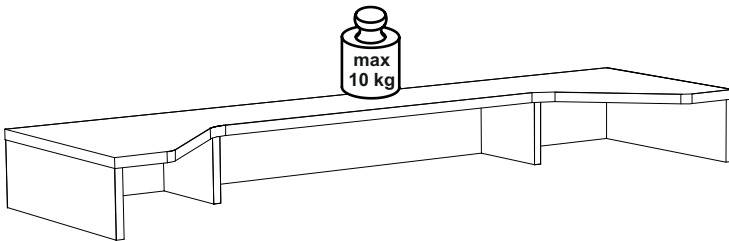
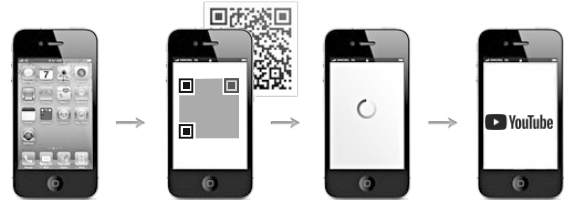

REPC-Nr.:



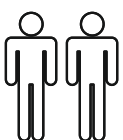
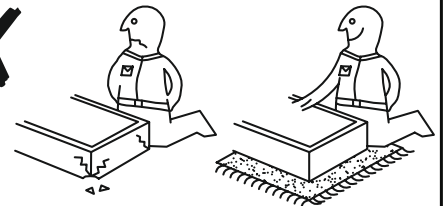
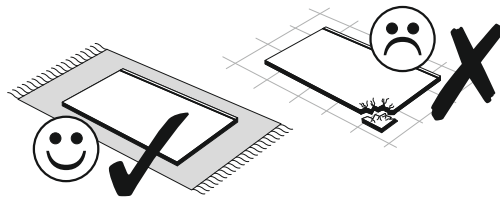
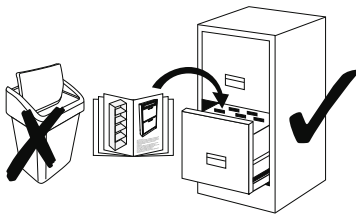
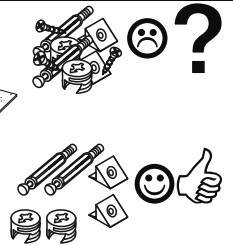
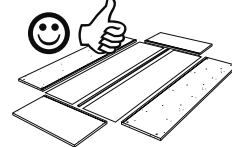
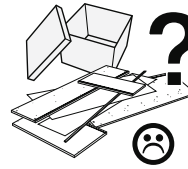
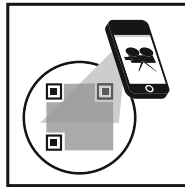
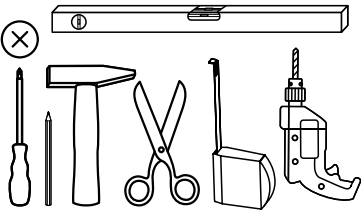

0216_GA Gaming-Aufsatz

Service • Assistenza • Dienstverlening • Serwis
Servis • Szerviz • Сервисная служба

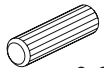

Das Ersatzteil-Anforderungsformular finden Sie auf <https://www.maeusbacher.de/ersatzteile/>

BT1-00274 1/1

B02-90 4x	 6x30	B02-10 8x		B02-20 8x	
B05-130 1x		B03-134 8x			

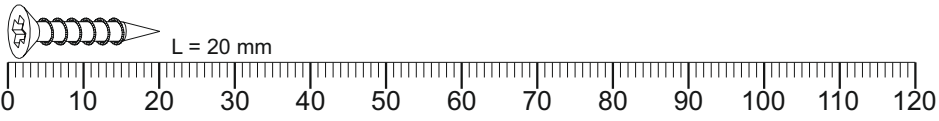
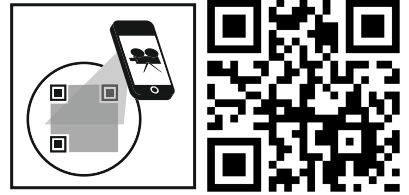

Paket 1/1

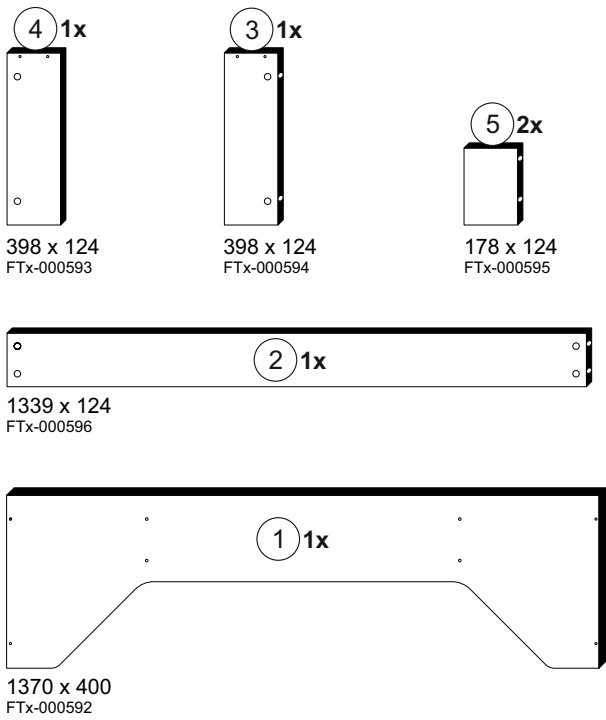

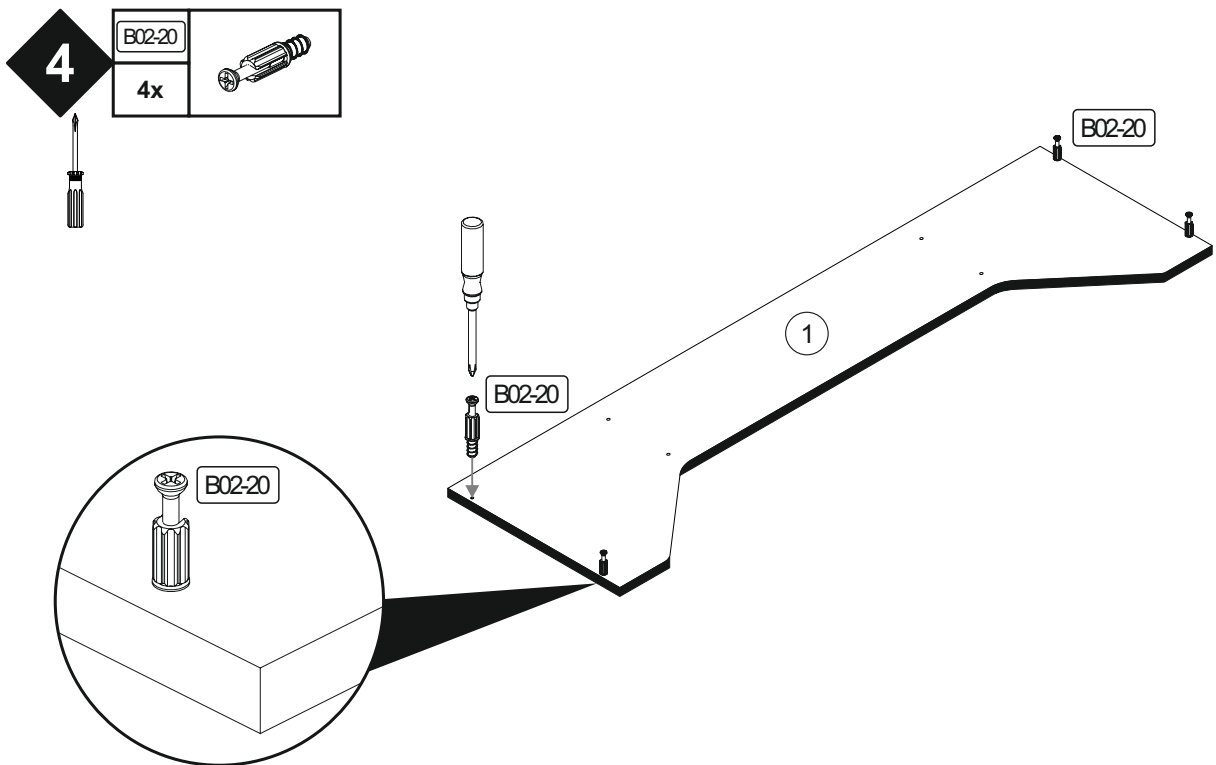
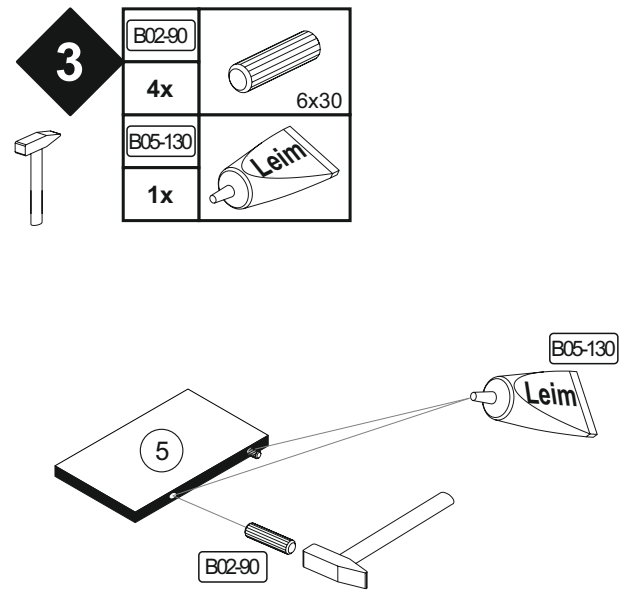
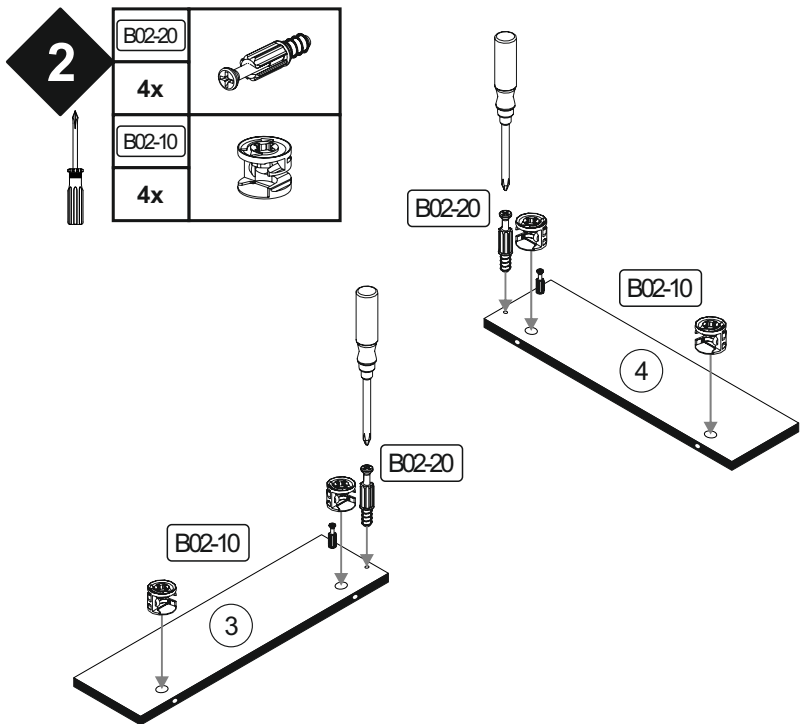
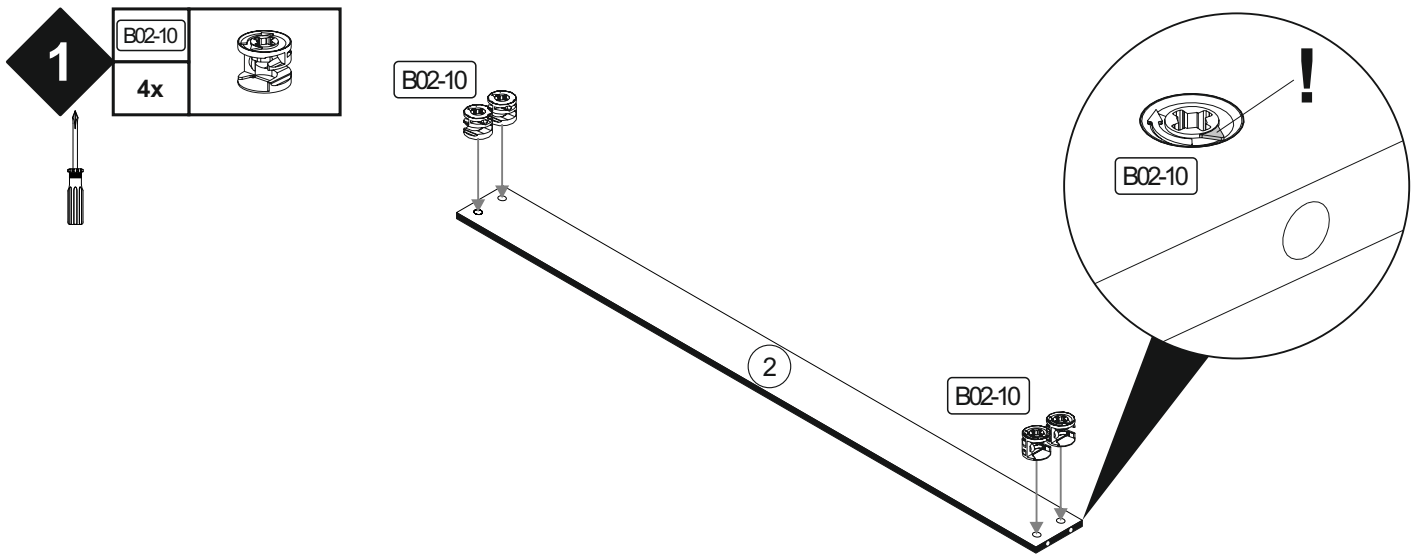

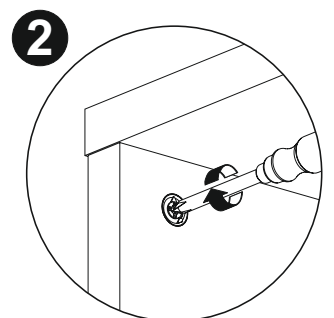
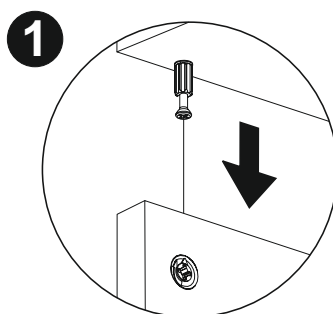
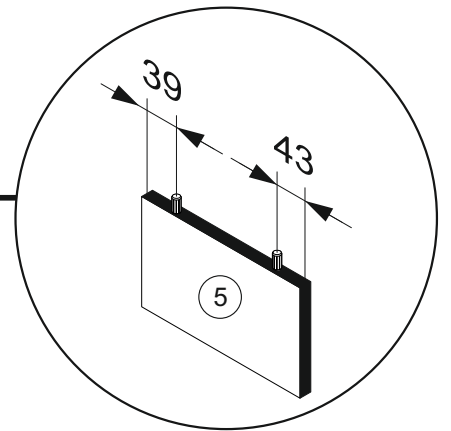
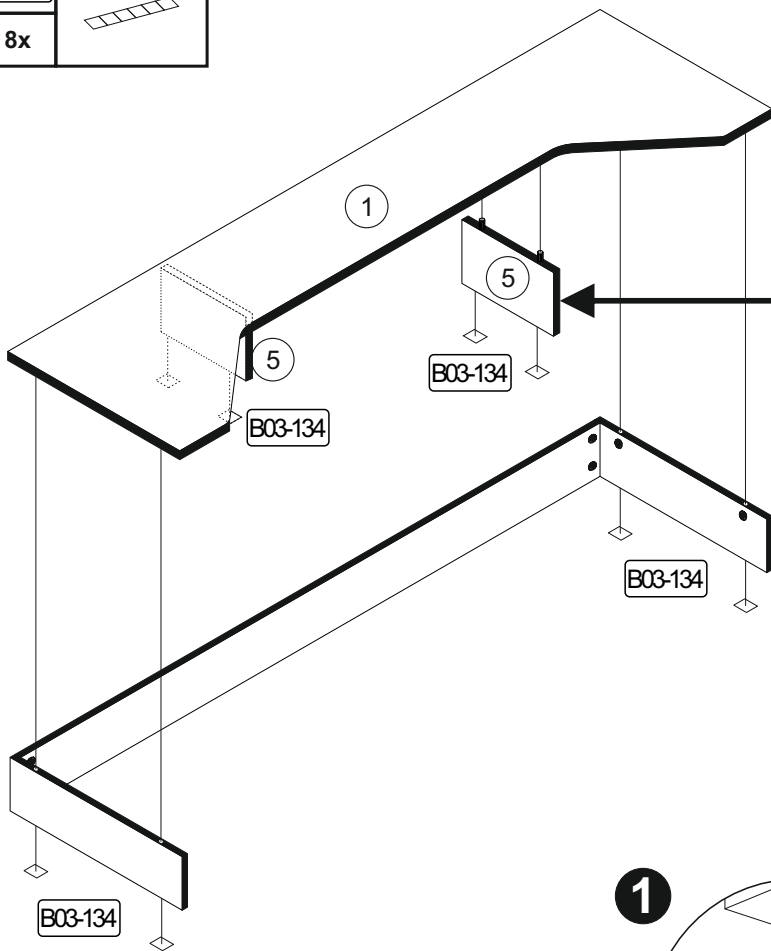
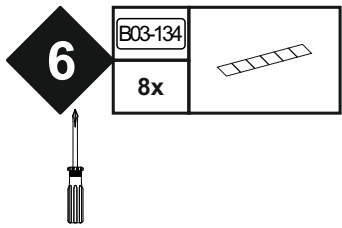
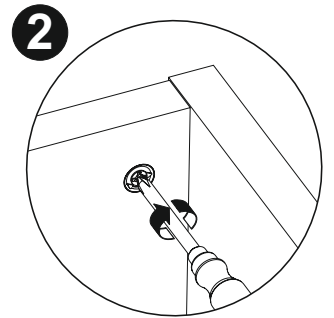
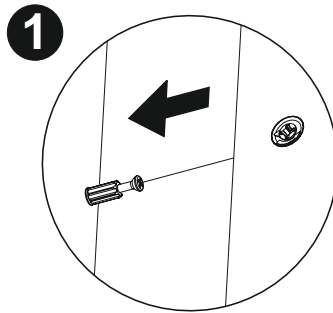
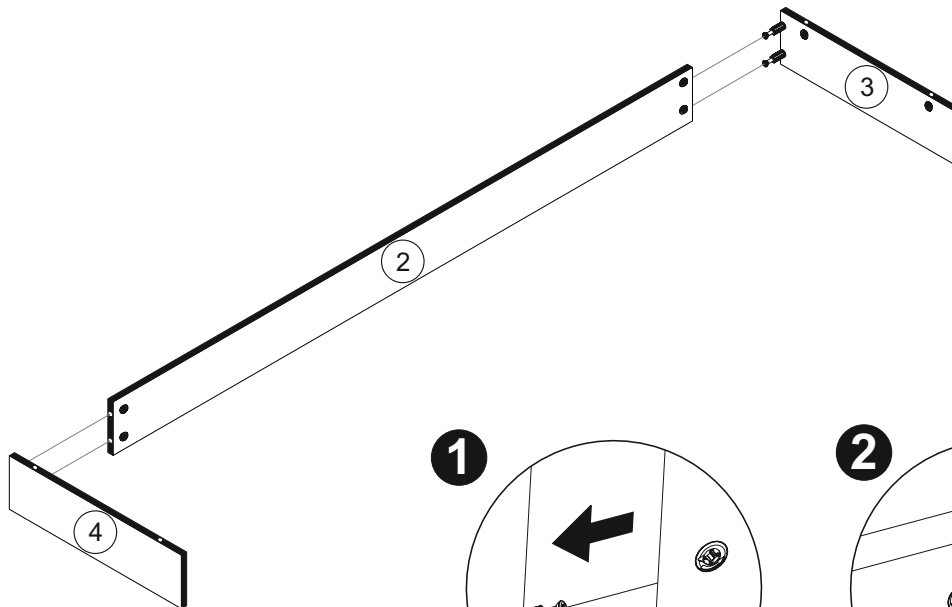



(D) Videounterstützte Montageanleitung

(TR) Video destekli kurulum talimatları

(RU) инструкция по монтажу с помощью видеосигнала

(RO) Instrucțiuni de instalare acceptate video

(GB) Video-assisted assembly instructions

(IT) Istruzioni di montaggio video-assistite

(CZ) Instalační pokyny podporované videem

(PL) Instrukcje montażu wspomagane sygnałem wizyjnym

(FR) Instructions de montage assistées par vidéo

(NL) Video-ondersteunde montage-instructies

(HU) Video-támogatott telepítési utasítások

(SK) Inštaláčn  pokyny podporované videom

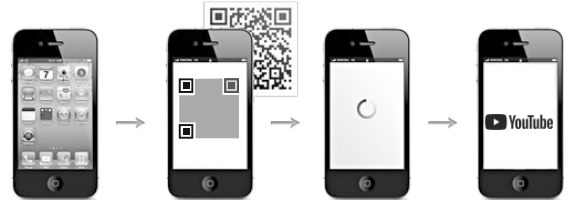
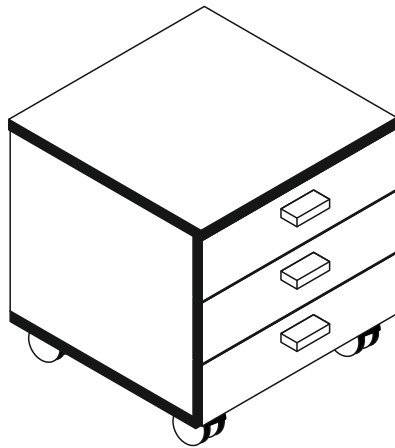

0203_03R Rollcontainer





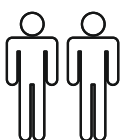
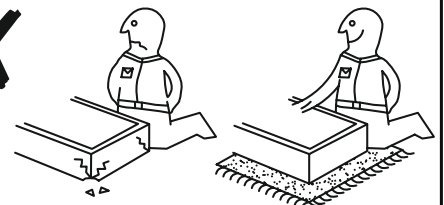
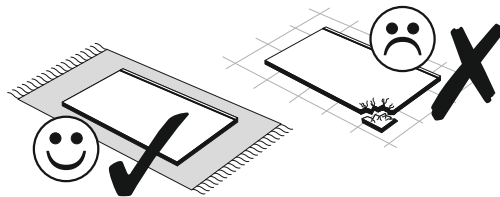
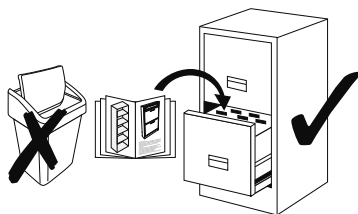
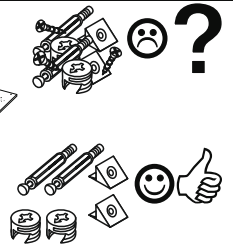
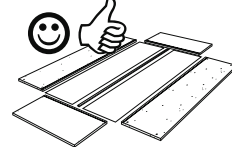
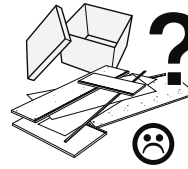
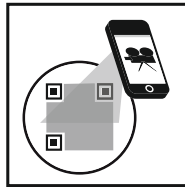
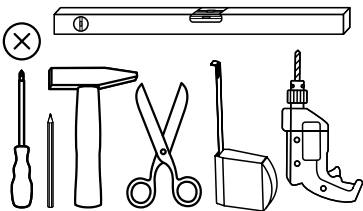

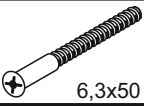

REPC-Nr.:

Service • Assistenza • Dienstverlening • Serwis
Servis • Szerviz • Сервисная служба





Das Ersatzteil-Anforderungsformular finden Sie auf <https://www.maeusbacher.de/ersatzteile/>

Beutel 1/2

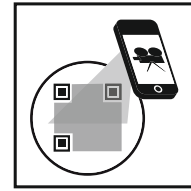
1-10 4x	 6,3x50	1-37 1x	 4,5x25	1-122 16x	 4x13	1-190 6x	 M4x20
2-10 4x		2-20 4x		1-200 18x	 6,3x13	1-330 6x	 M4x10



Beutel 2/2

3-130 6x		5-130 2x	 LEIM	6-401 3x	
-------------	---	-------------	--	-------------	---

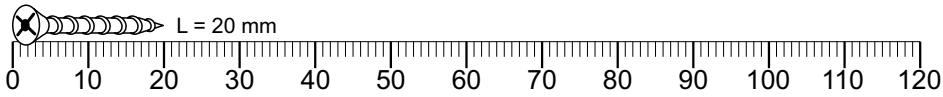

Colli 1/1

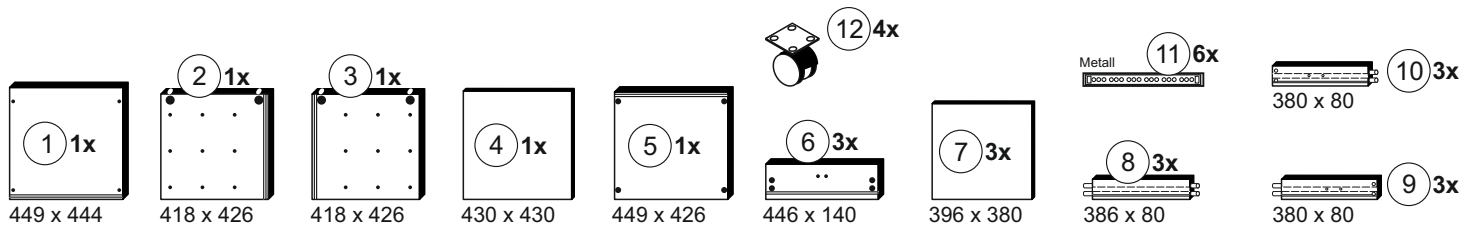

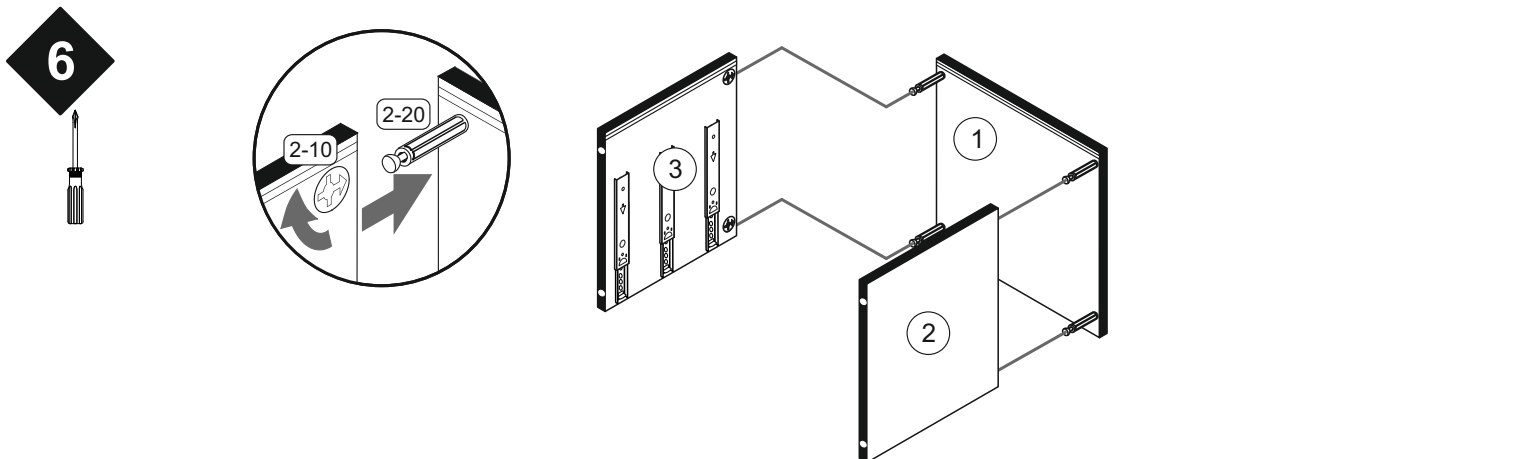
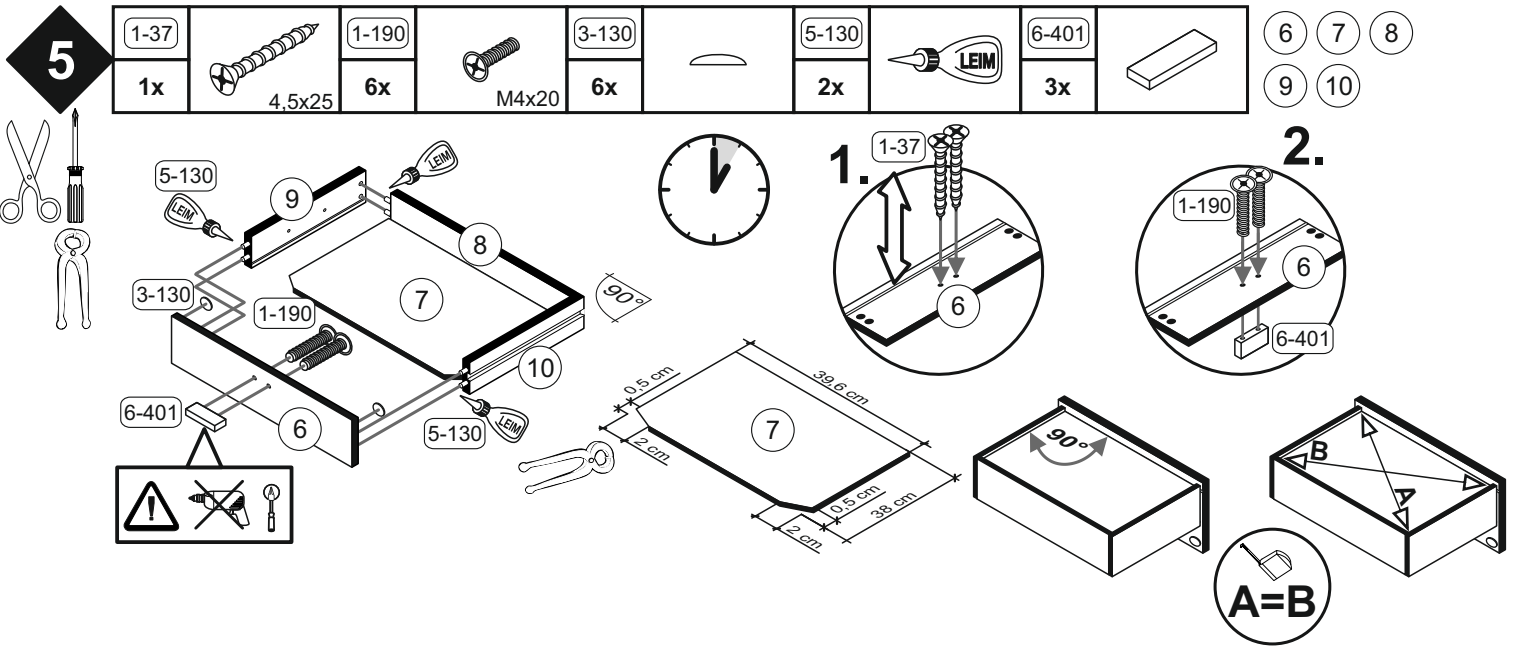
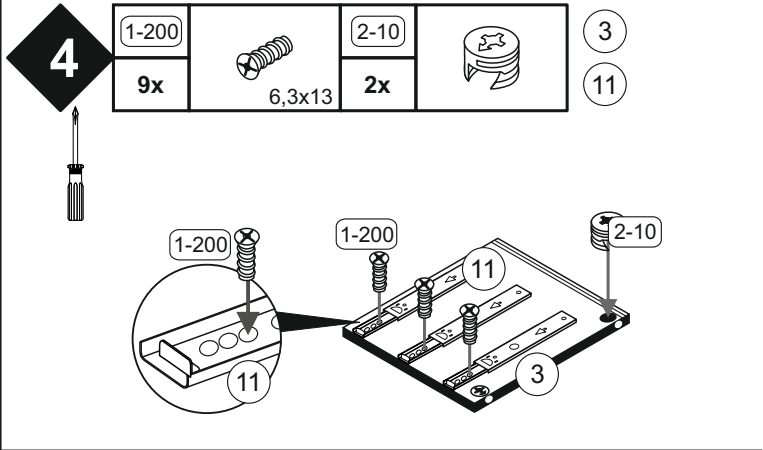
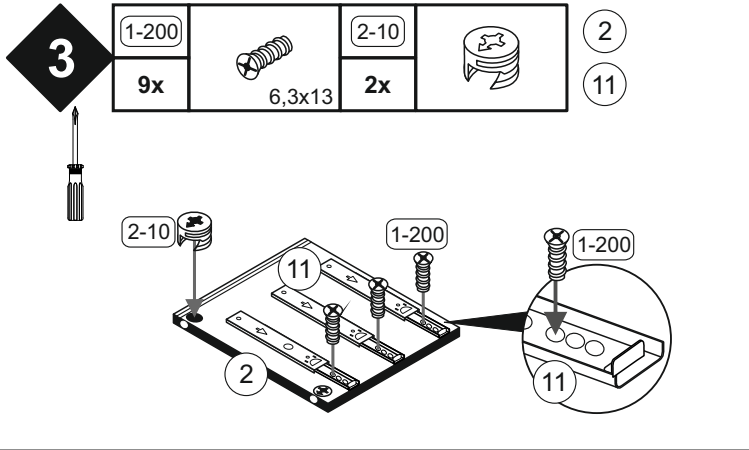
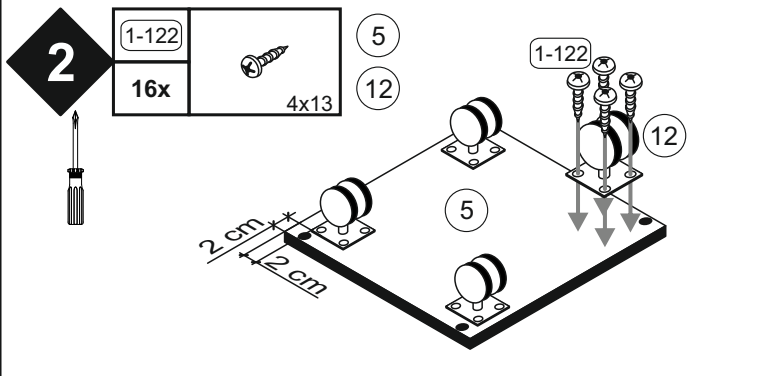
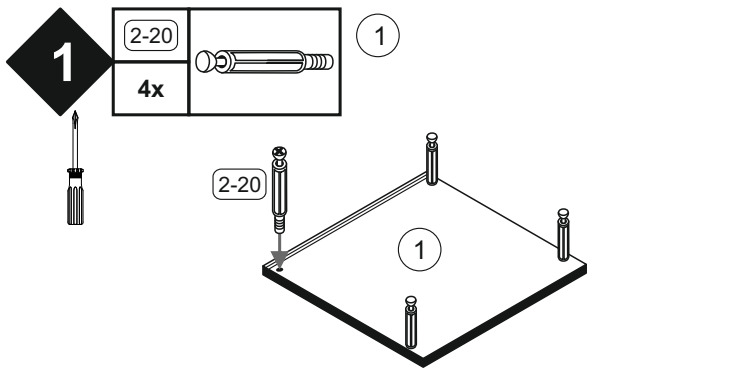

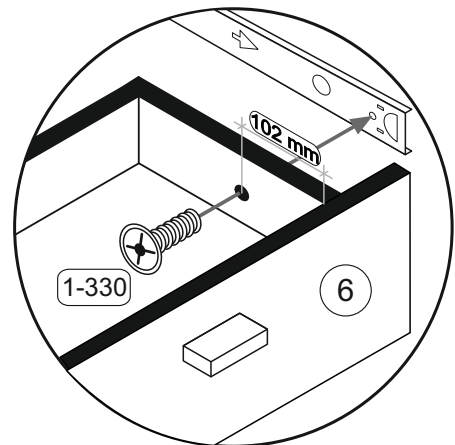
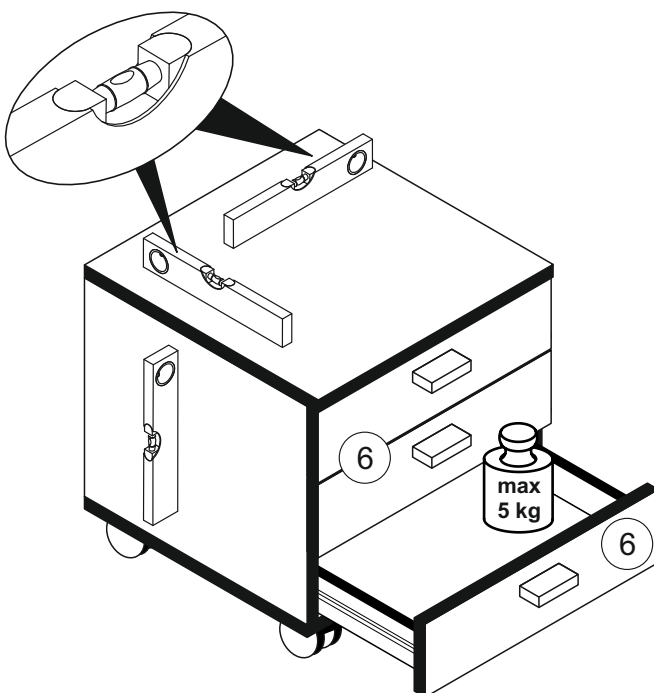
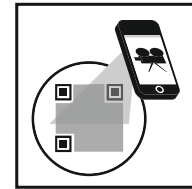
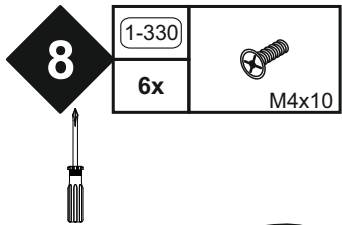
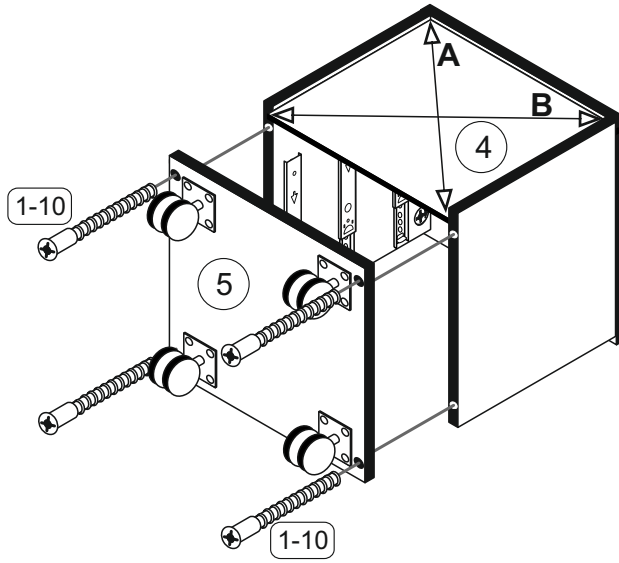
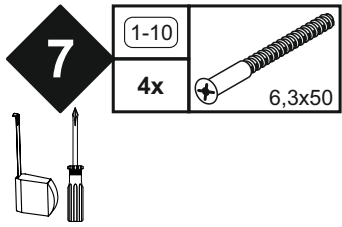



D Videounterstützte Montageanleitung

TR Video destekli kurulum talimatları

RU инструкция по монтажу с помощью видеосигнала

RO Instrucțiuni de instalare acceptate video

GB Video-assisted assembly instructions

IT Istruzioni di montaggio video-assistite

CZ Instalační pokyny podporované videem

PL Instrukcje montażu wspomagane sygnałem wizyjnym

FR Instructions de montage assistées par vidéo

NL Video-ondersteunde montage-instructies

HU Video-támogatott telepítési utasítások

SK Inštačné pokyny podporované videom

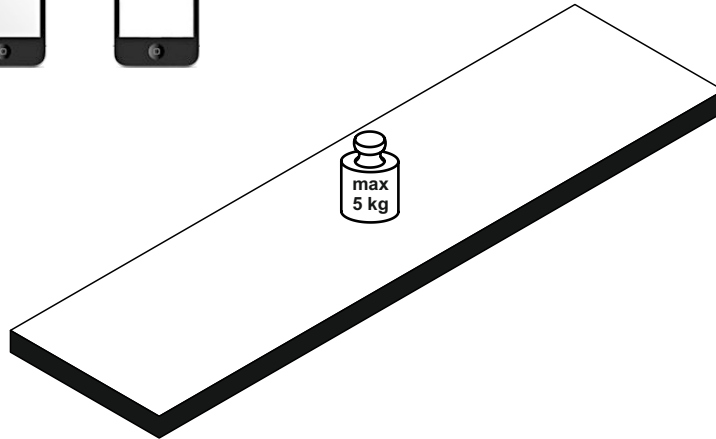
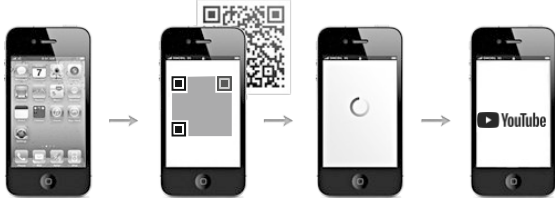

0521_90

Wandsteckboard

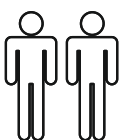
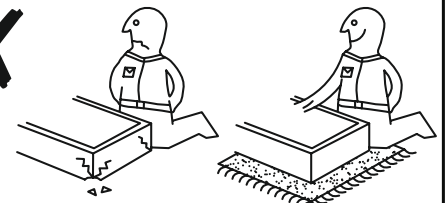
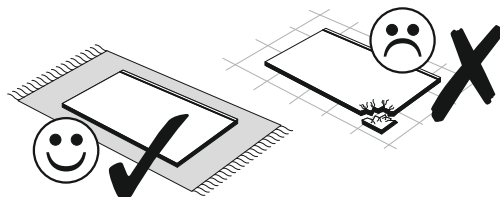
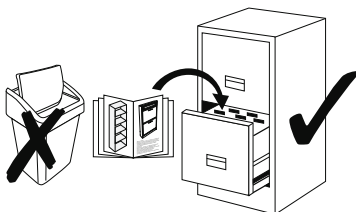
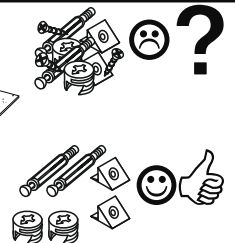
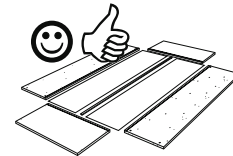
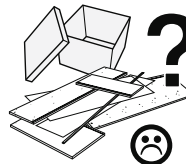
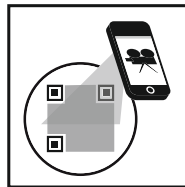
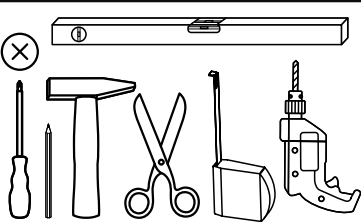

REPC-Nr.:

Service • Assistenza • Dienstverlening • Serwis
Servis • Szerviz • Сервисная служба

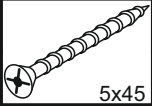

Das Ersatzteil-Anforderungsformular finden Sie auf <https://www.maeusbacher.de/ersatzteile/>

0521/60 B1 Colli 1/1

1-177		8-70	
4x	5x45	4x	Ø8

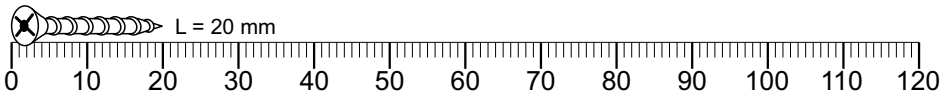
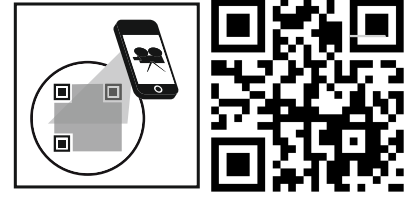

Colli 1/1

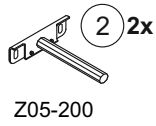
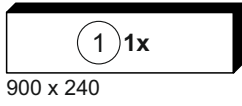

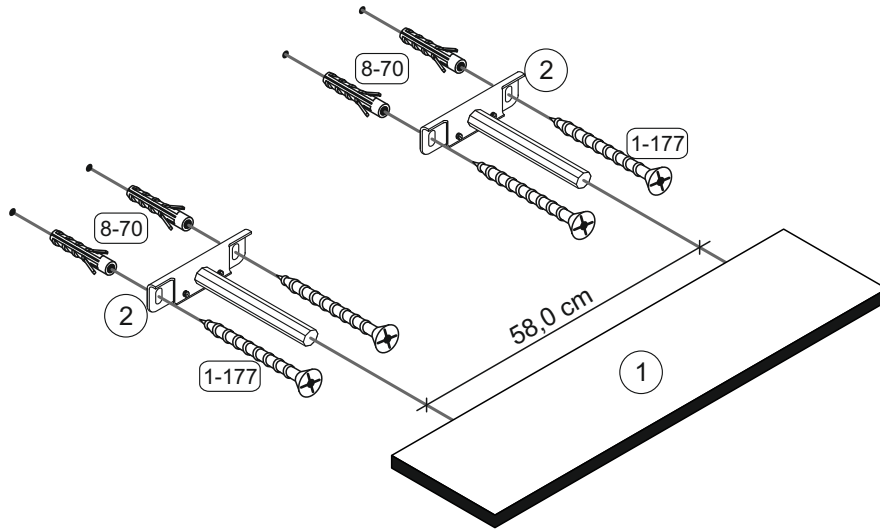
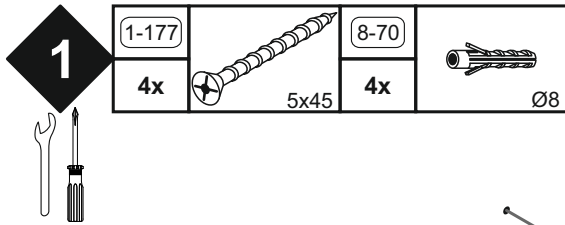

Höhenverstellung :

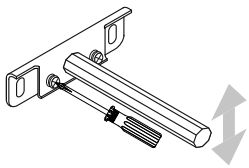

Seitenverstellung :

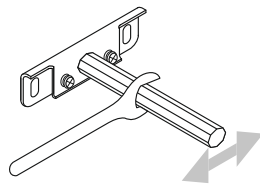

Achtung • Attention • Attenzione • Opgelet • Uwaga • Pozor • Figyelem • Atenție • Dikkat • Внимание	
(D)	Wandbefestigung dient als Kippschutz - unbedingt anbringen! Bei einigen Wandtypen kann ein Spezialdübel erforderlich sein!
(GB)	The wall fastening serves to prevent tipping - be absolutely sure to mount it! For certain wall types, a special wall plug may be necessary!
(FR)	La fixation murale sert de protection contre le basculement – à installer impérativement ! Pour certains types de murs il faut des chevilles spéciales !
(TR)	Duvardaki sabitleme, devrilmeye karşı bir emniyet tedbiridir ve mutlaka monte edilmelidir! Bazı duvar tiplerinde bunun için özel bir dübel gerekli olabilir!
(IT)	Il fissaggio alla parete serve da protezione anti-ribaltamento – attaccarla assolutamente! Per alcune strutture di parete può essere necessario un tassello speciale!
(NL)	Bevestiging aan de muur dient als kantelbescherming – zeker en vast bevestigen! Bij enkele muurtypes is een speciale plug misschien vereist!
(RU)	Обязательно установите крепление на стене во избежание опрокидывания! Для некоторых типов стен может потребоваться специальный дюбель!
(CZ)	Montáž na stěnu slouží jako ochrana proti převrnutí – bezpodmínečně umístěte! U některých typů stěn může být zapotřebí speciální hmoždinka!
(HU)	A terméket a falhoz kel rögzíteni, különben az felborulhat! Egyes faltípusoknál speciális tiplit kell használni!
(RO)	Sistemul de fixare la perete servește ca protecție la răsturnare - de montat obligatoriu! Pentru unele tipuri de pereți este posibil să fie necesar un diblu special!
(PL)	Mocowanie do ściany jest jednocześnie zabezpieczeniem przed przewróceniem – koniecznie zamontować! Do niektórych rodzajów ścian koniecznie zastosować specjalne kołki mocujące.
(SK)	Upevnenie na stenu slúži ako ochrana proti prevráteniu – bezpodmienečne použiť! Pre niektoré druhy stien môže byť potrebná špeciálna hmoždinka!