

Installation Instruction

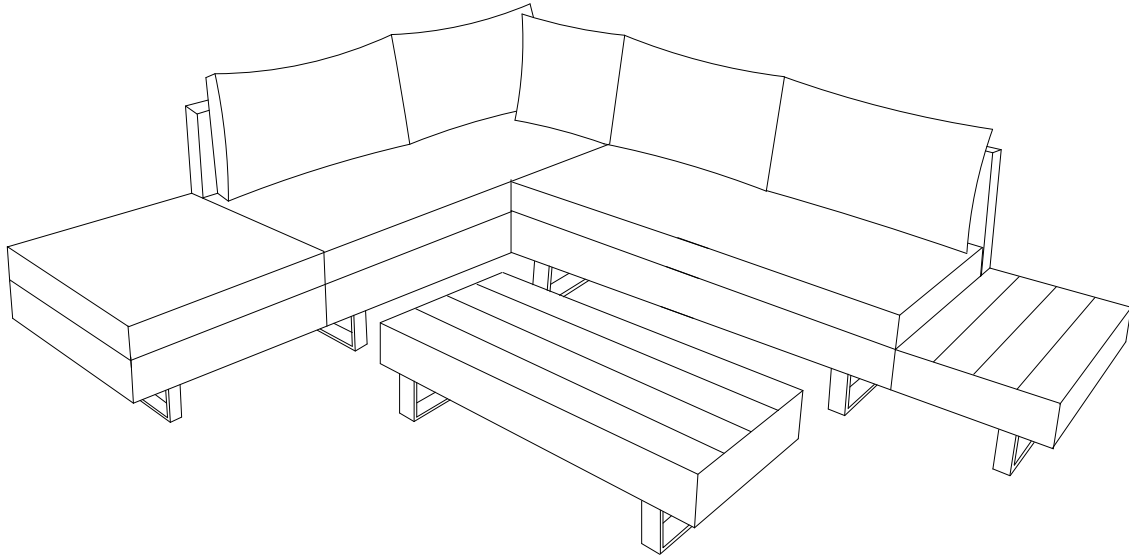

WF317222/WF317223/WF317224

TIPPS

1. Dieses Produkt wird für die Lieferung in 2 Pakete aufgeteilt. Sie kommen möglicherweise nicht gleichzeitig an. Bitte warte geduldig .
2. Wir danken Ihnen für den Einkauf! Wir bemühen uns, Ihnen qualitativ hochwertige Produkte zu bieten. In seltenen Fällen, dass Ihr Produkt beschädigt ist, Teile fehlt oder Sie auf Probleme bei der Montage stoßen, wenden Sie sich bitte an unseren Kundendienst, wir werden Ihnen die beste Lösung so schnell wie möglich bieten. Um Ihr Problem schnell zu lösen, bitte stellen Sie uns einige Bilder zur Verfügung, die das Produktproblem deutlich widerspiegeln können. Vielen Dank !
3. Setzen Sie die Schrauben in die Löcher ein und ziehen Sie die Schrauben an, aber nicht zu fest, 70 % ~ 80 % ist genug, und ziehen Sie schließlich alle Schrauben an. Wenn einige Schrauben nicht mit den Löchern ausgerichtet sind oder die Montage einiger Teile schwierig ist, stellen Sie bitte den Straffheitsgrad der Schrauben um.
4. Es wird empfohlen, dass 2 Personen das Produkt installieren.









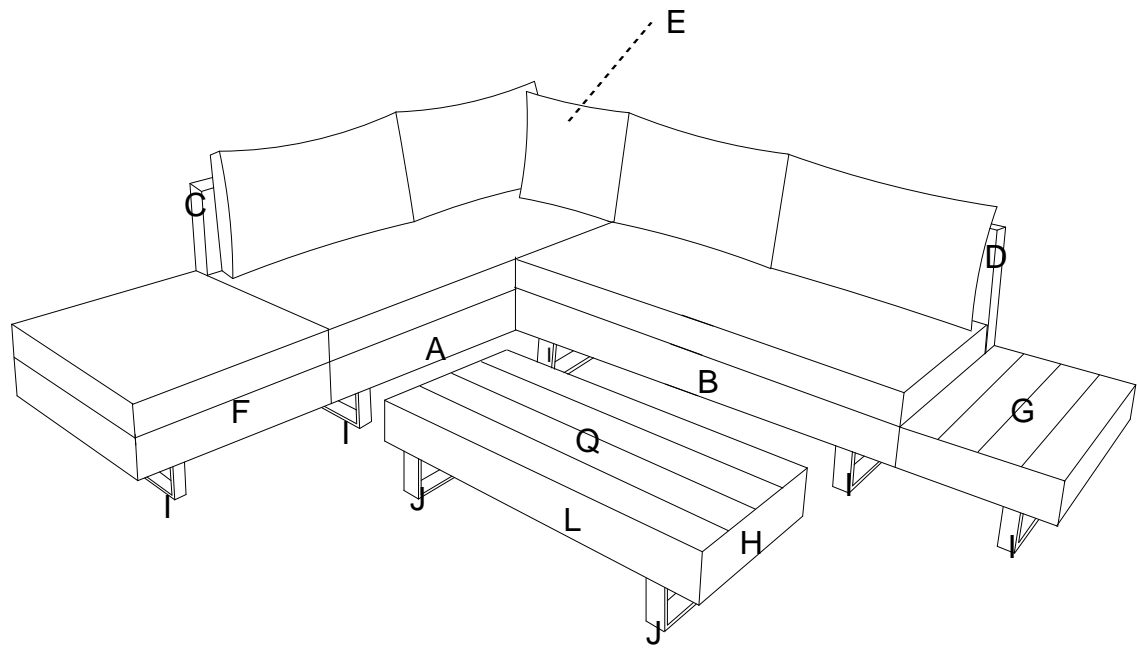

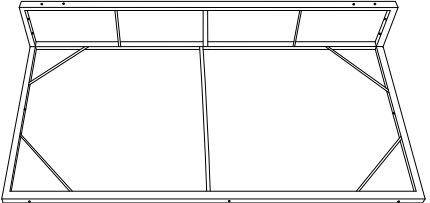
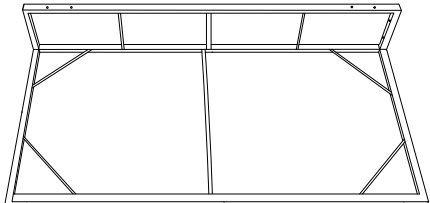
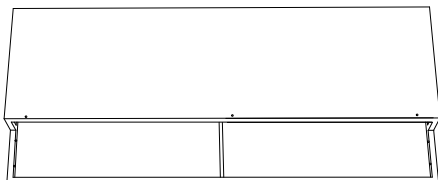
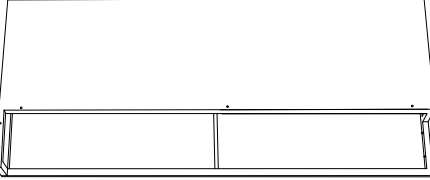
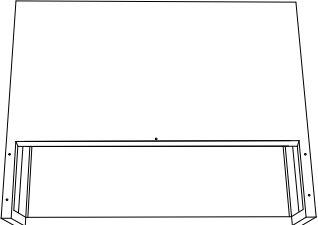

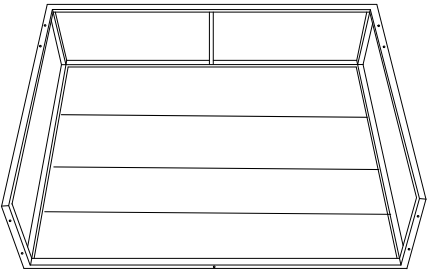
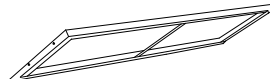
Tips

- 1.This product will be split into 2 packages for delivery. They may not arrive at the same time. Please wait patiently.
- 2.Thank you for shopping! We strive to provide you with high quality products. In rare cases that your product is damaged, missing parts or you encounter assembly problems, please contact our customer service with it, we will offer you the best solution as soon as possible. In order to solve your problem quickly, please provide us with some pictures that can clearly reflect the product problem. Thanks very much !
3. Insert the screws in holes and tighten the screws, but not too tight, 70%~80% is ok, finally tighten all the screws. If some issues happened that some screws can not target to the hole or some parts are difficult to install, please adjust the tightness of the screws.
4. 2 people are recommended to finish

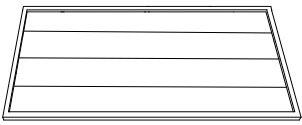
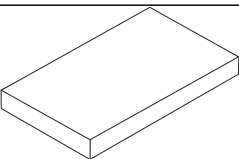
Conseils

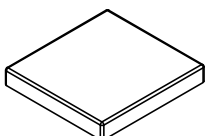
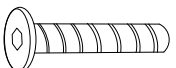
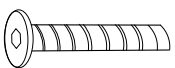
1. Ce produit sera divisé en 2 colis pour la livraison. Il se peut qu'ils n'arrivent pas en même temps. S'il vous plaît, attendez patiemment.
2. Merci pour vos achats! Nous nous efforçons de vous fournir des produits de haute qualité. Dans les rares cas où votre produit est endommagé, des pièces manquantes ou si vous rencontrez des problèmes d'assemblage, veuillez contacter notre service client, nous vous proposerons la meilleure solution dans les plus brefs délais. Afin de résoudre votre problème rapidement, veuillez nous fournir quelques images pouvant refléter clairement le problème du produit. Merci beaucoup !
3. Insérez les vis dans les trous et serrez les vis, mais pas trop fort, 70 % ~ 80 % est ok, serrez enfin toutes les vis. Si des problèmes surviennent et que certaines vis ne peuvent pas cibler le trou ou que certaines pièces sont difficiles à installer, veuillez ajuster le serrage des vis.
4. Il est recommandé d'être 2 personnes pour terminer

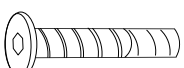

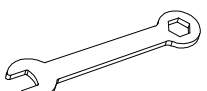
<p>A</p>  <p>X1</p>	<p>B</p>  <p>X1</p>	<p>C</p>  <p>X1</p>
<p>D</p>  <p>X1</p>	<p>E</p>  <p>X1</p>	<p>F</p>  <p>X1</p>
<p>G</p>  <p>X1</p>	<p>H</p>  <p>X2</p>	<p>I</p>  <p>X6</p> <p>J</p>  <p>X2</p>
<p>K</p>  <p>X1</p>	<p>Q</p>  <p>X1</p>	<p>Double Seat Cushion</p>  <p>X2</p>
<p>L</p>  <p>X2</p>	<p>Back Cushion</p>  <p>X5</p>	<p>Seat Cushion</p>  <p>X1</p>
<p>M</p>  <p>M 6X35</p> <p>X31</p>	<p>N</p>  <p>M 6X16</p> <p>X32</p>	<p>X1</p>  <p>X1</p>
<p>O</p>  <p>M 6X 50</p> <p>X 8</p>	<p>P</p>  <p>X 8</p>	<p>X1</p>  <p>X1</p>

WF317222

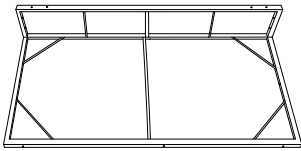

Ax1

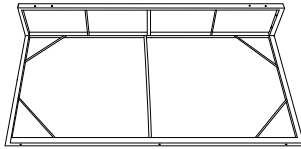

Bx1

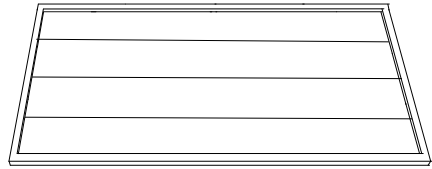

Qx1

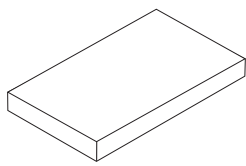

**Double Seat
Cushion x2**

WF317223

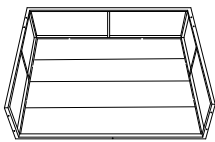

Fx1

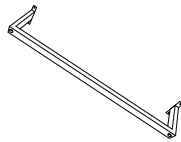

lx6

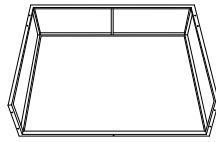

Gx1

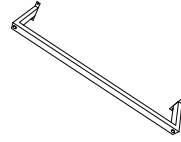

Jx2



Back Cushion x2

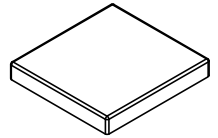

**Seat Cushion
x1**

WF317224

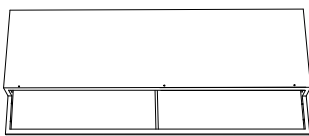

Cx1

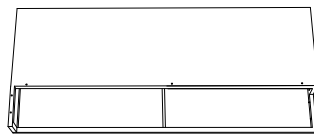

Dx1

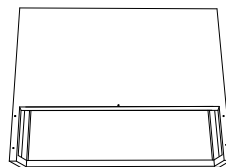

Ex1

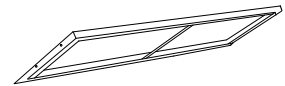

Hx2

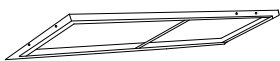

Kx1



Lx2



**Back Cushion
x3**

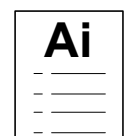

NOTE: 50% TIGHTEN BEFORE FIXING ALL BOLTS

1

M

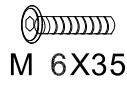

4 pcs

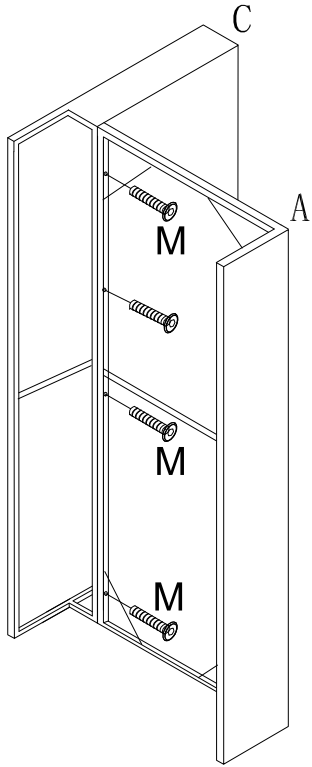

2

M

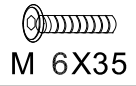

5 pcs

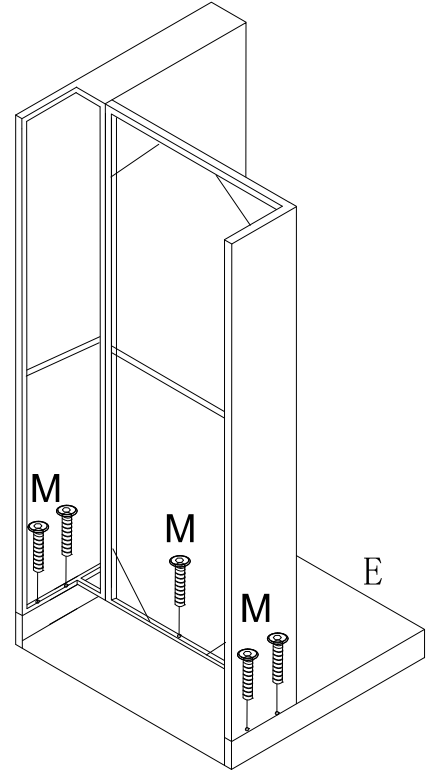

3

N



8 pcs

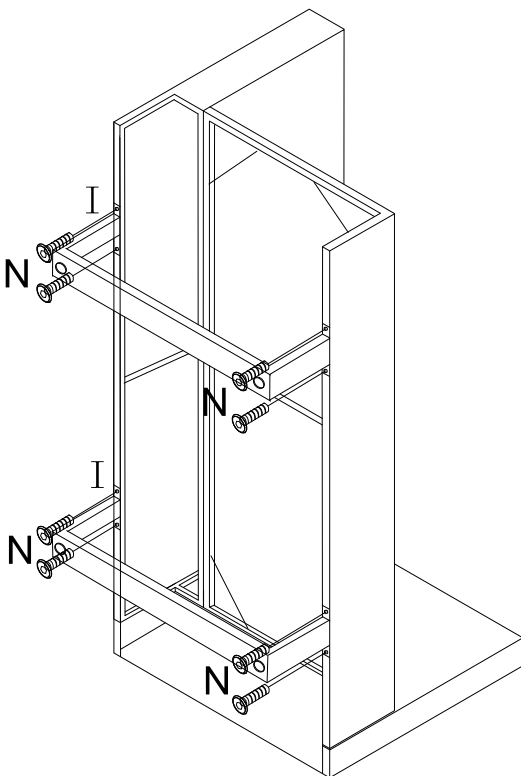

4

N

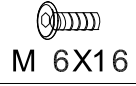

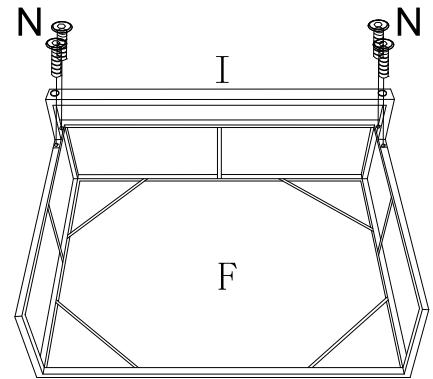

4 pcs



NOTE: 50% TIGHTEN BEFORE FIXING ALL BOLTS

5

O	 M 6X50	4 pcs
P		4 pcs
M	 M 6X35	1 pcs

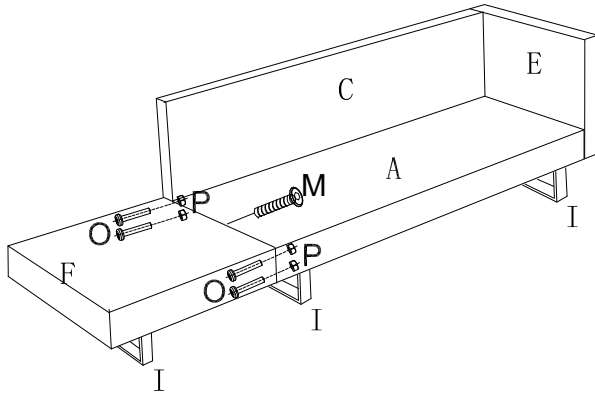

6

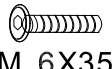
M	 M 6X35	8 pcs
---	---	-------

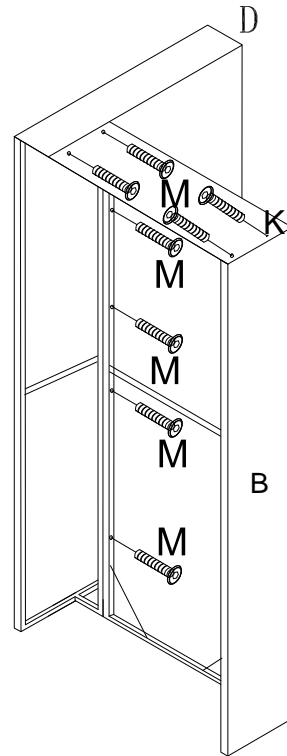

7

N	 M 6X16	8 pcs
---	---	-------

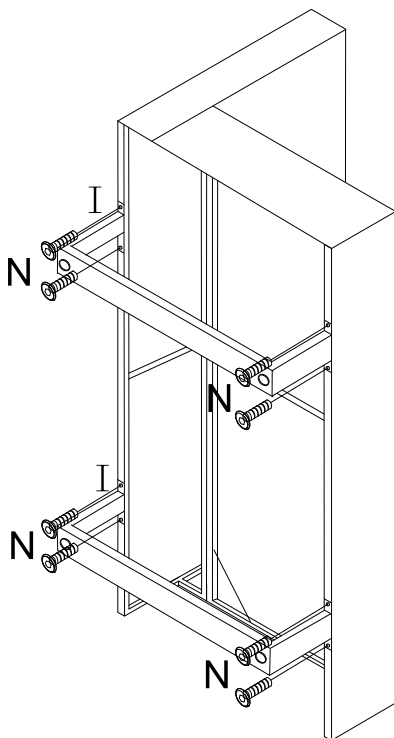

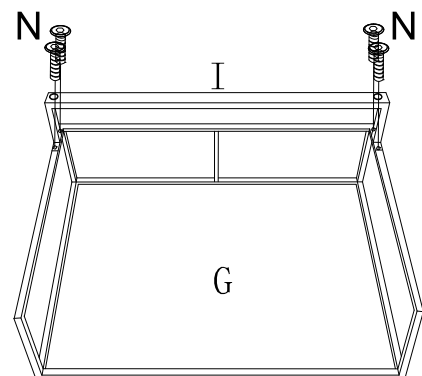

8

N	 M 6X16	4 pcs
---	---	-------

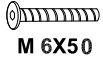

NOTE: 50% TIGHTEN BEFORE FIXING ALL BOLTS

9

O	 M 6X50	4 pcs
P		4 pcs
M	 M 6X35	1 pcs

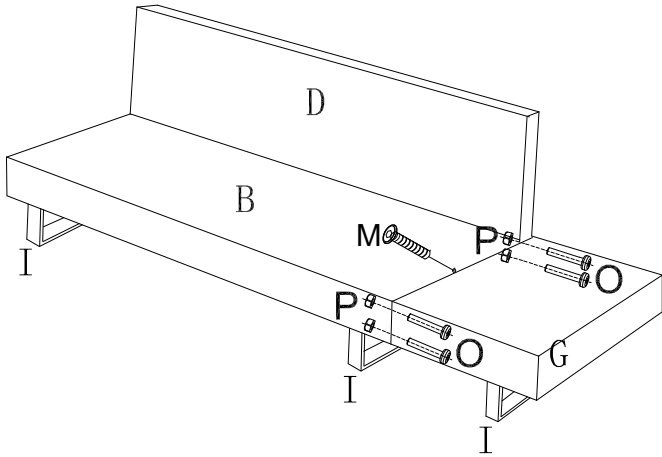

10

M	 M 6X35	8 pcs
---	---	-------

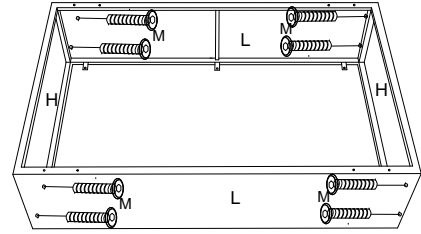

11

M	 M 6X35	4 pcs
---	---	-------

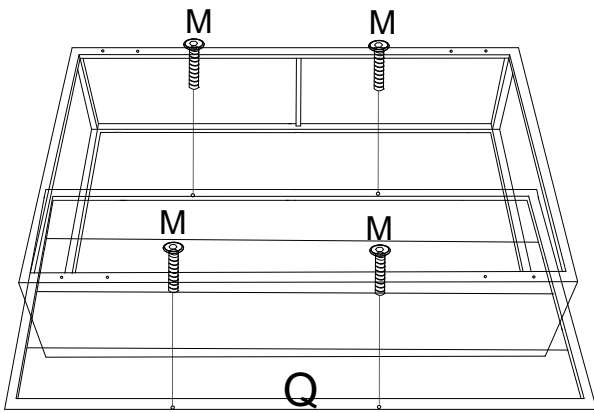

14

N	 M 6X16	8 pcs
---	---	-------

