

2344

Versionsnummer:
Version number:
Numer wersji:

11.2019

Naturholz kann sich werkstoffbedingt verziehen. Durch das Montieren ziehen sich Teile wieder plan.
Wood is a natural material and can be distorted. However, when the furniture is assembled, the parts straighten out.
Drewno jest surowcem naturalnym i może ulec wypaczeniu. Jednakże, po zmontowaniu mebla w całość części wyprostowują się.

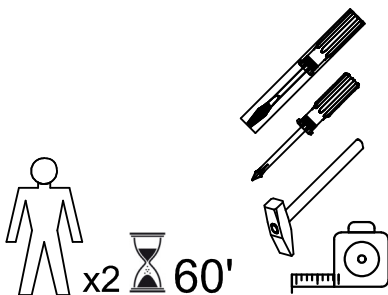
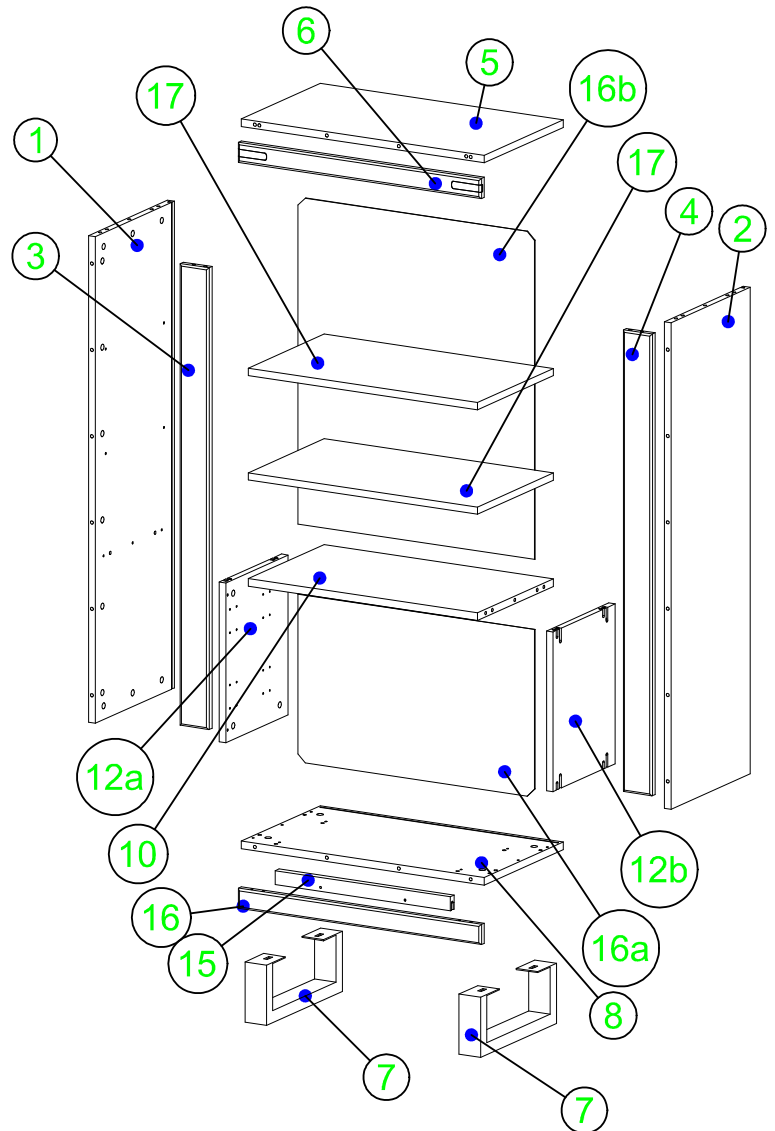
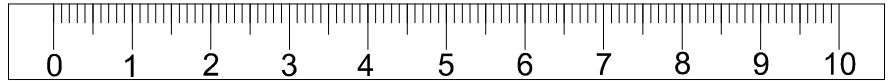



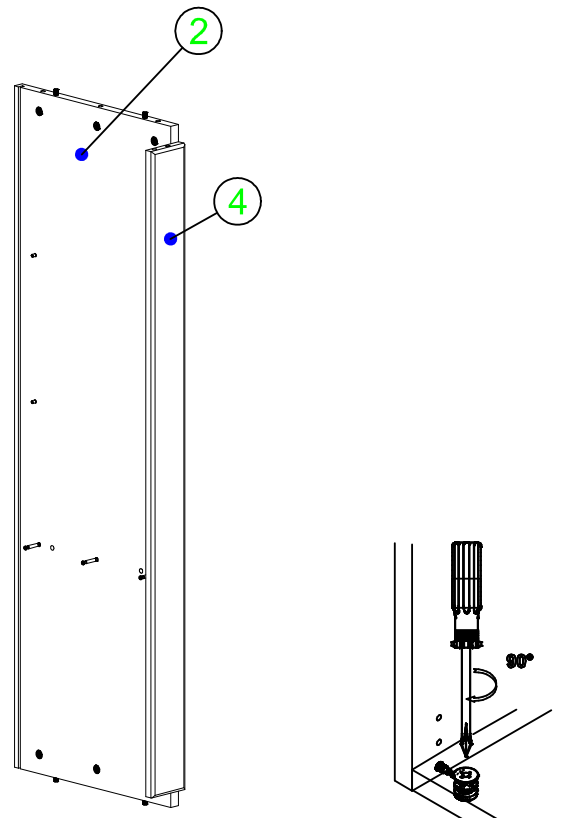
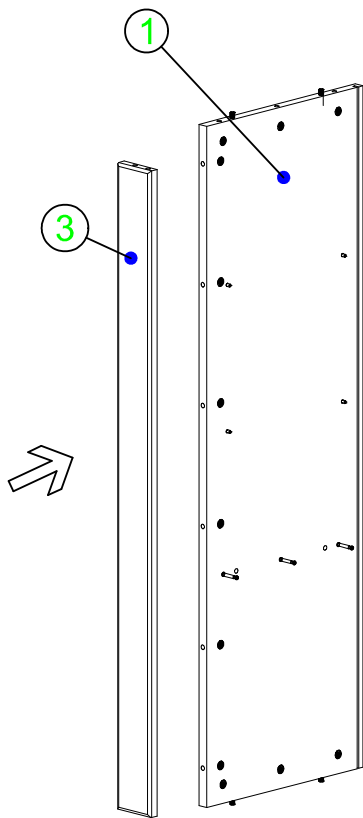
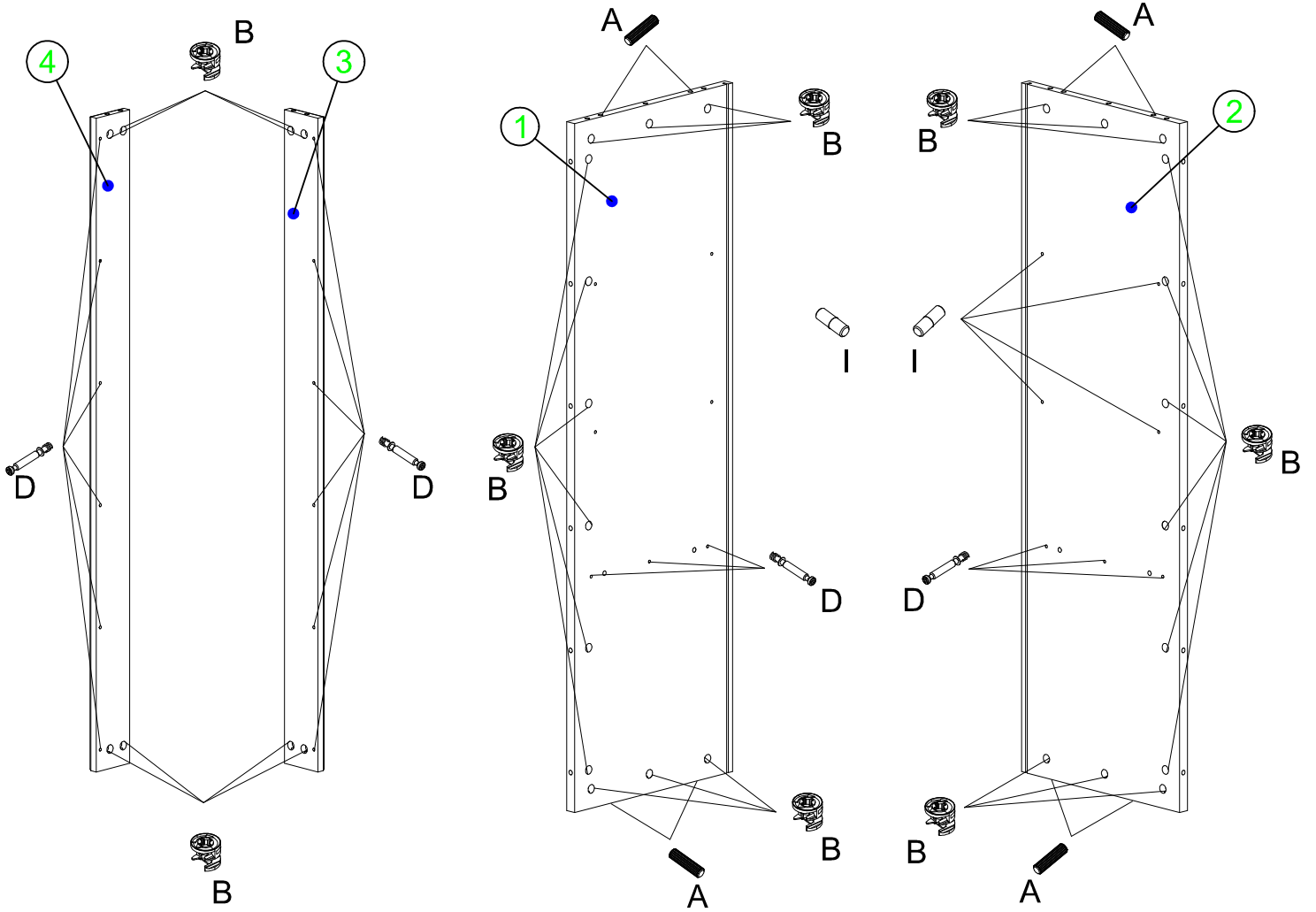



A Ø 8x30 22	B 64	D 64	G Ø 4x30 2	H 20	I 8	J Ø 5x13 16	I 8	L Ø 7x50 8
M 2	O 4	R M4x30 4	S 4	T Ø 3x16 4	P 6	N 16	Filz/Filz 4	U 1

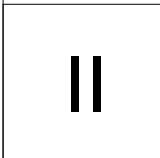
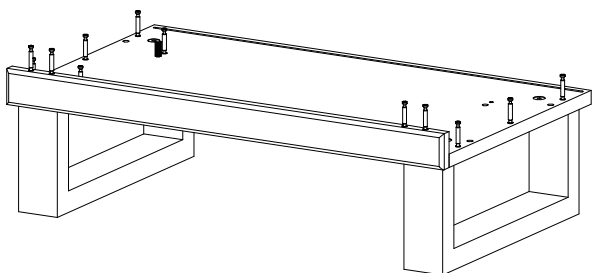
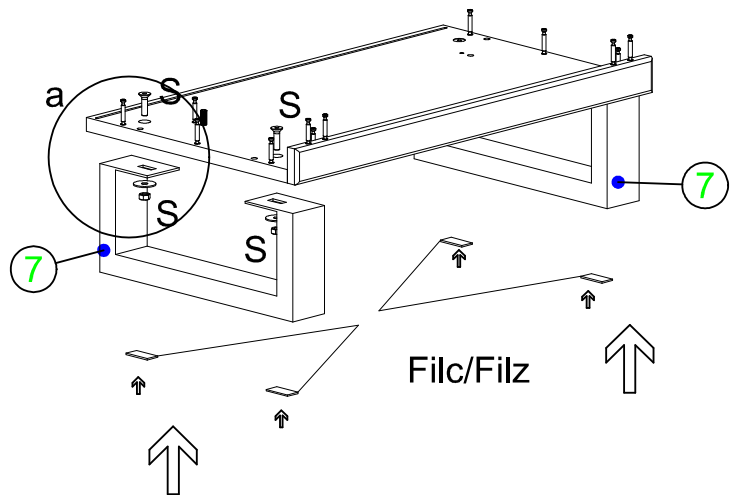
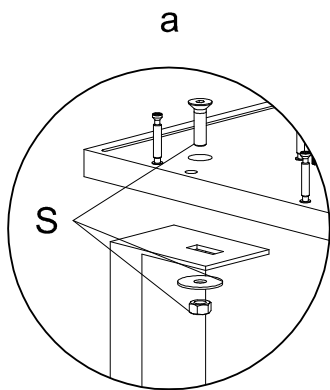
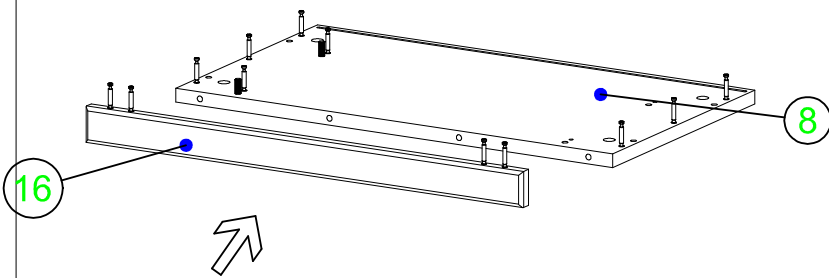
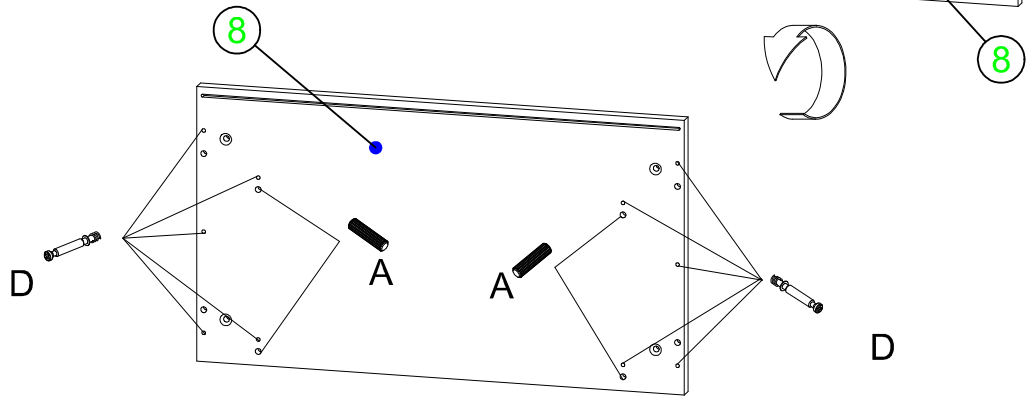
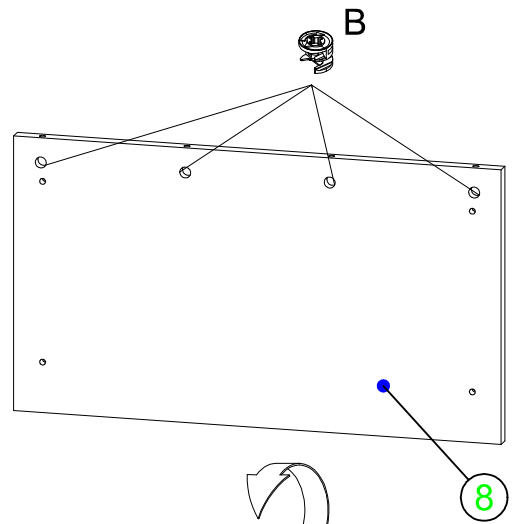
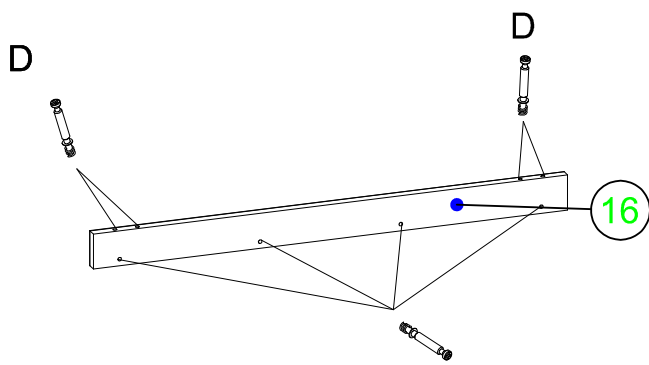

I



<p>A</p> <p>∅ 8x30 8</p>	<p>B</p> <p>32</p>	<p>D</p> <p>18</p>	<p>I</p> <p>8</p>
------------------------------	--------------------	--------------------	-------------------

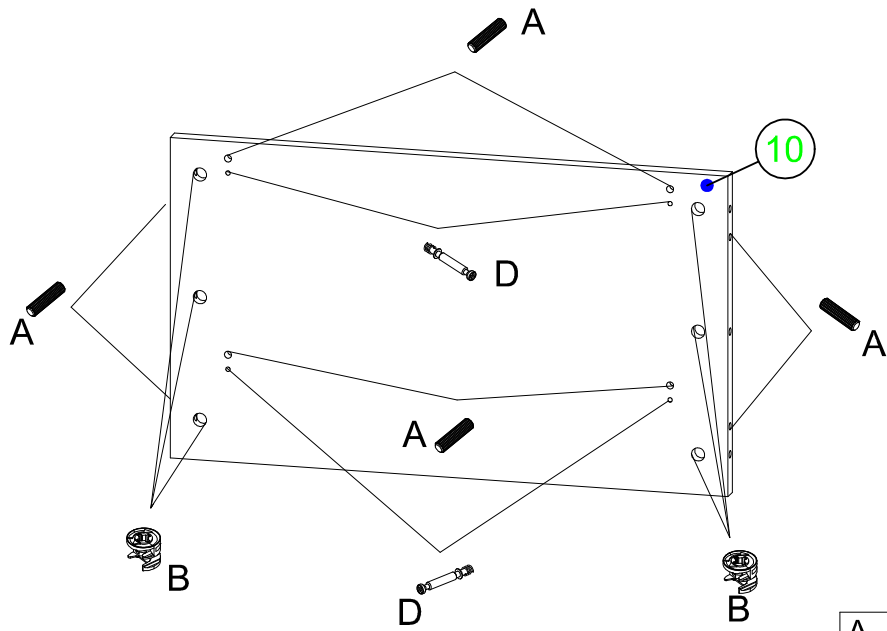

<p>A</p>  <p>Ø 8x30 4</p>	<p>B</p>  <p>4</p>	<p>D</p>  <p>18</p>	<p>Filc / Filz</p>  <p>4</p>	<p>S</p>  <p>4</p>
---	---	---	--	--

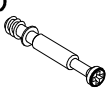

III

<p>A</p>  <p>Ø 8x30 8</p>	<p>B</p>  <p>6</p>	<p>D</p>  <p>4</p>
--	---	---

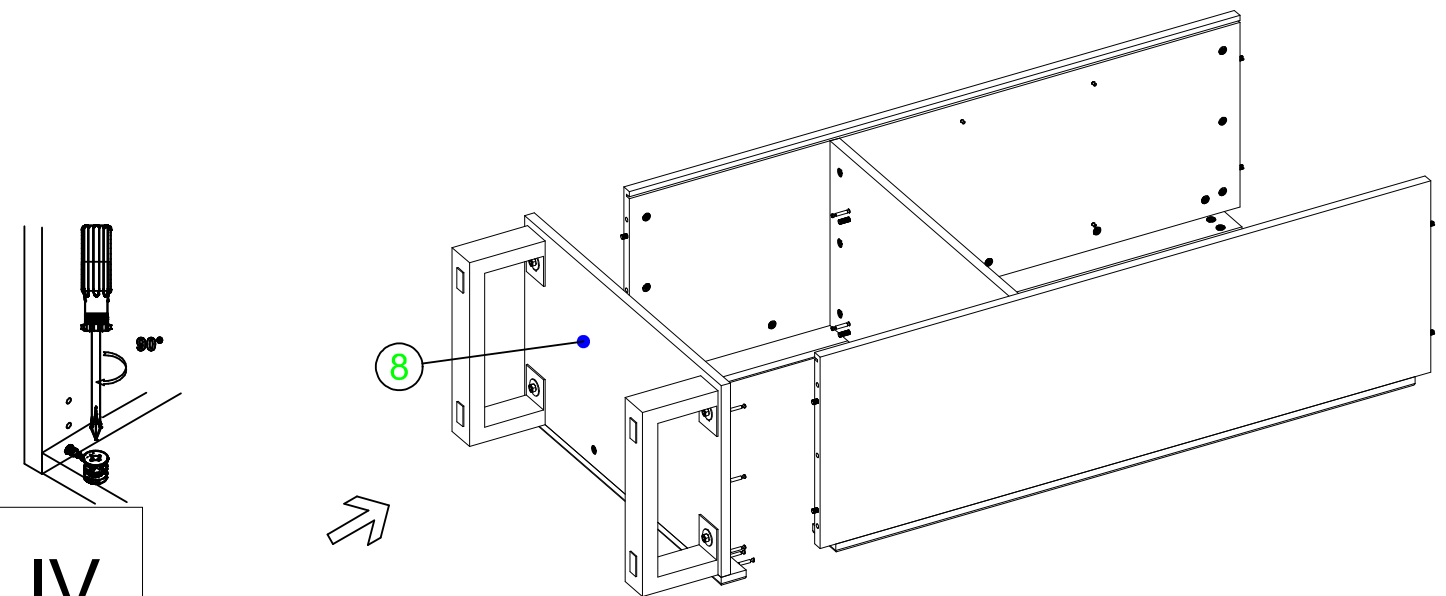
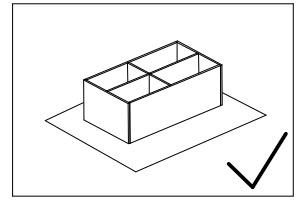
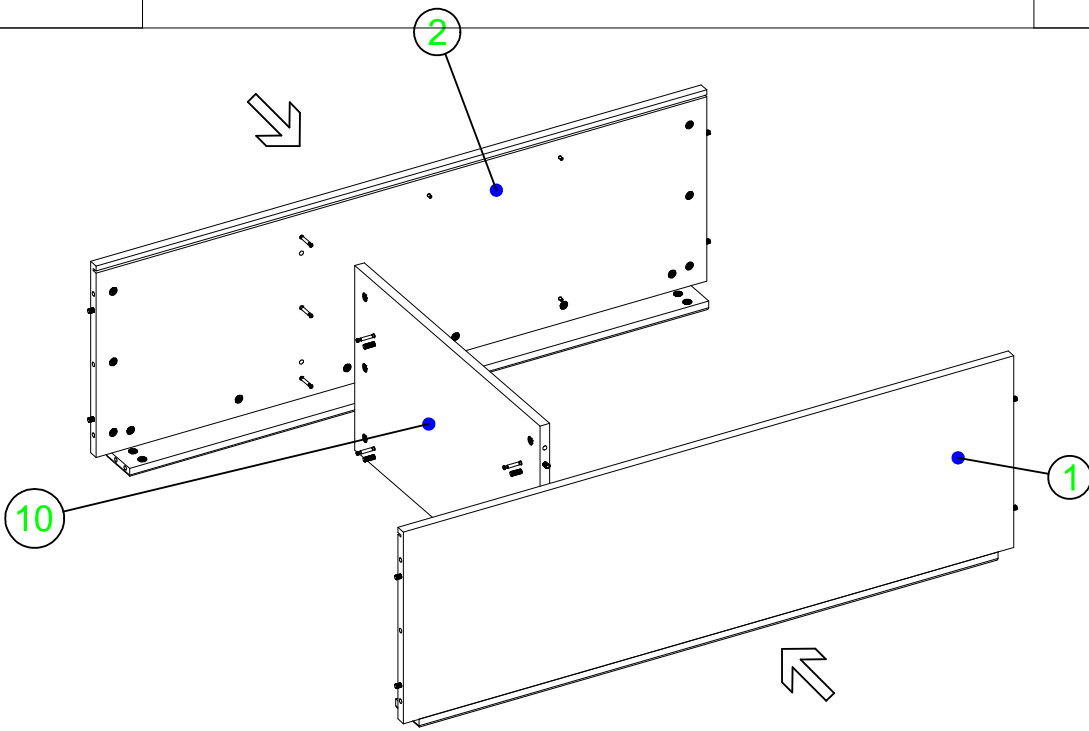

IV

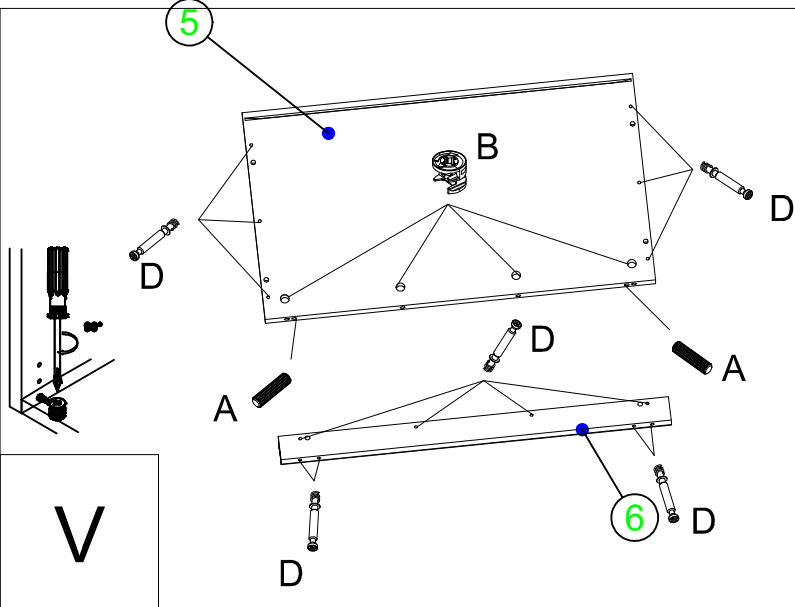

5

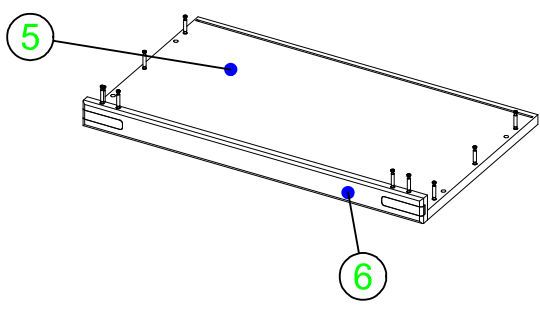

5

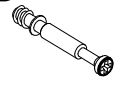

V

<p>A</p>  <p>∅ 8x30 2</p>	<p>B</p>  <p>4</p>	<p>D</p>  <p>14</p>
--	---	--

16b

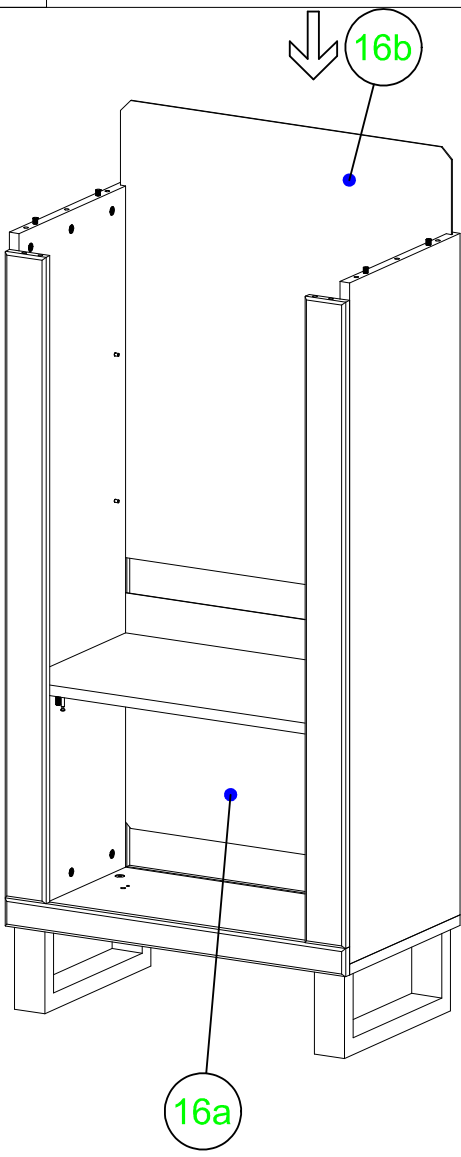

16a

↓

5

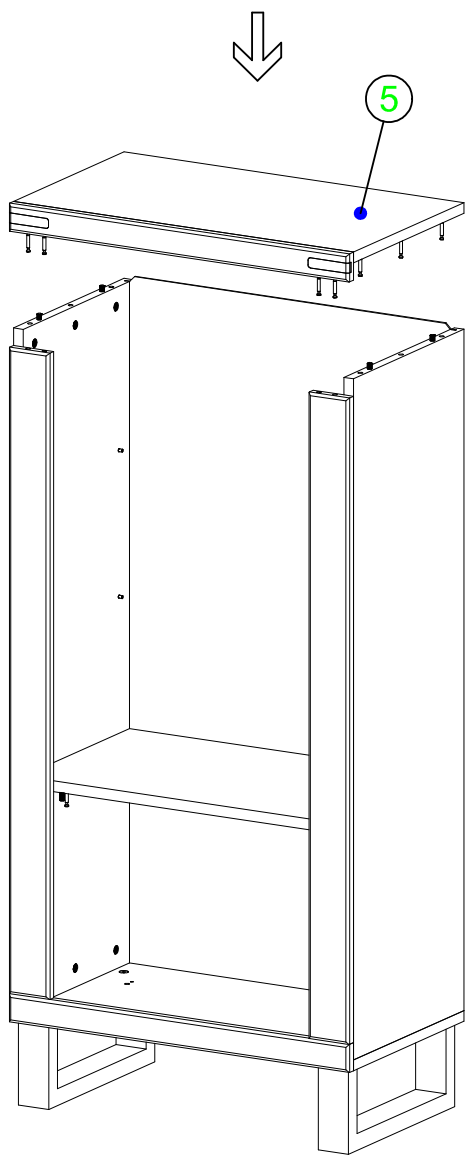

VI

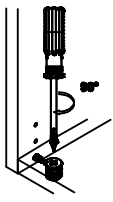

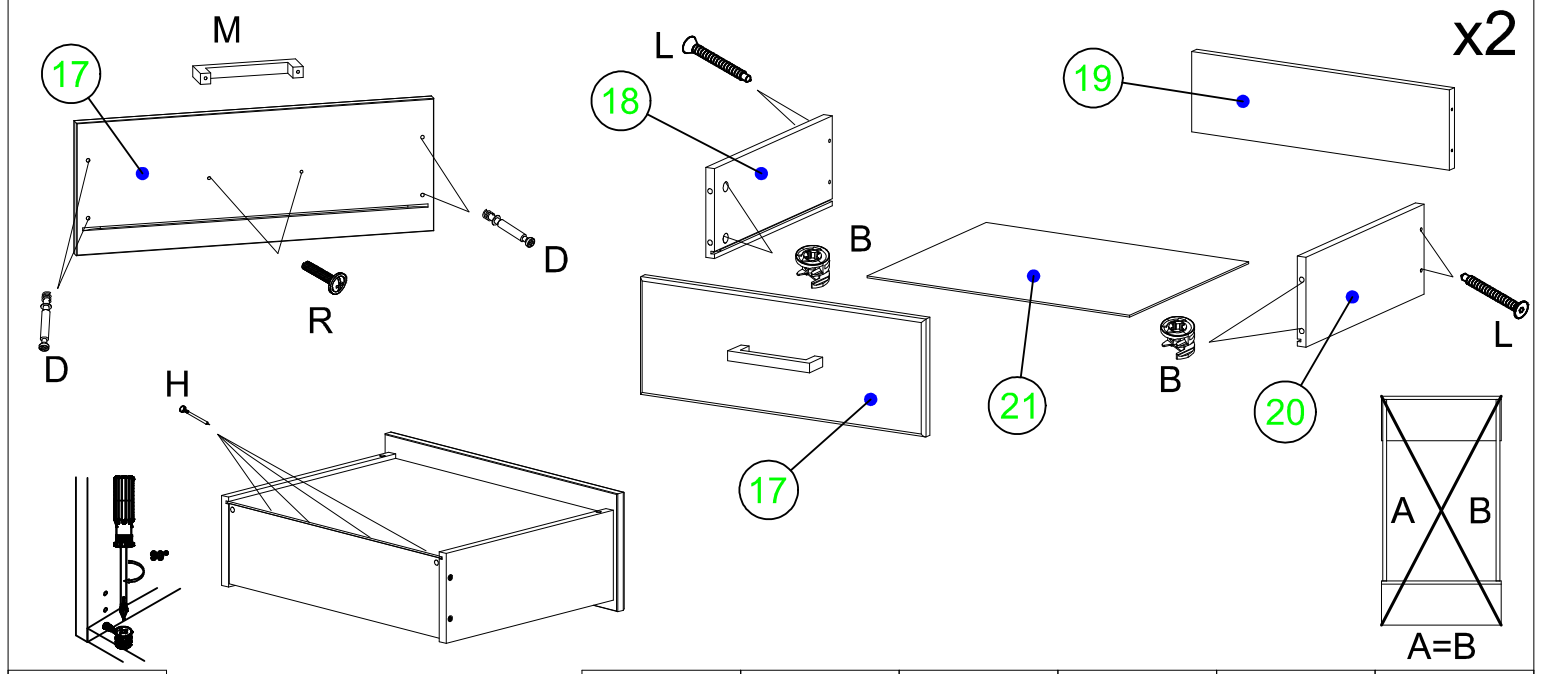

VIII

B	D	H	L	M	R
8	8	8	Ø 7x50 8	2	M4x30 4

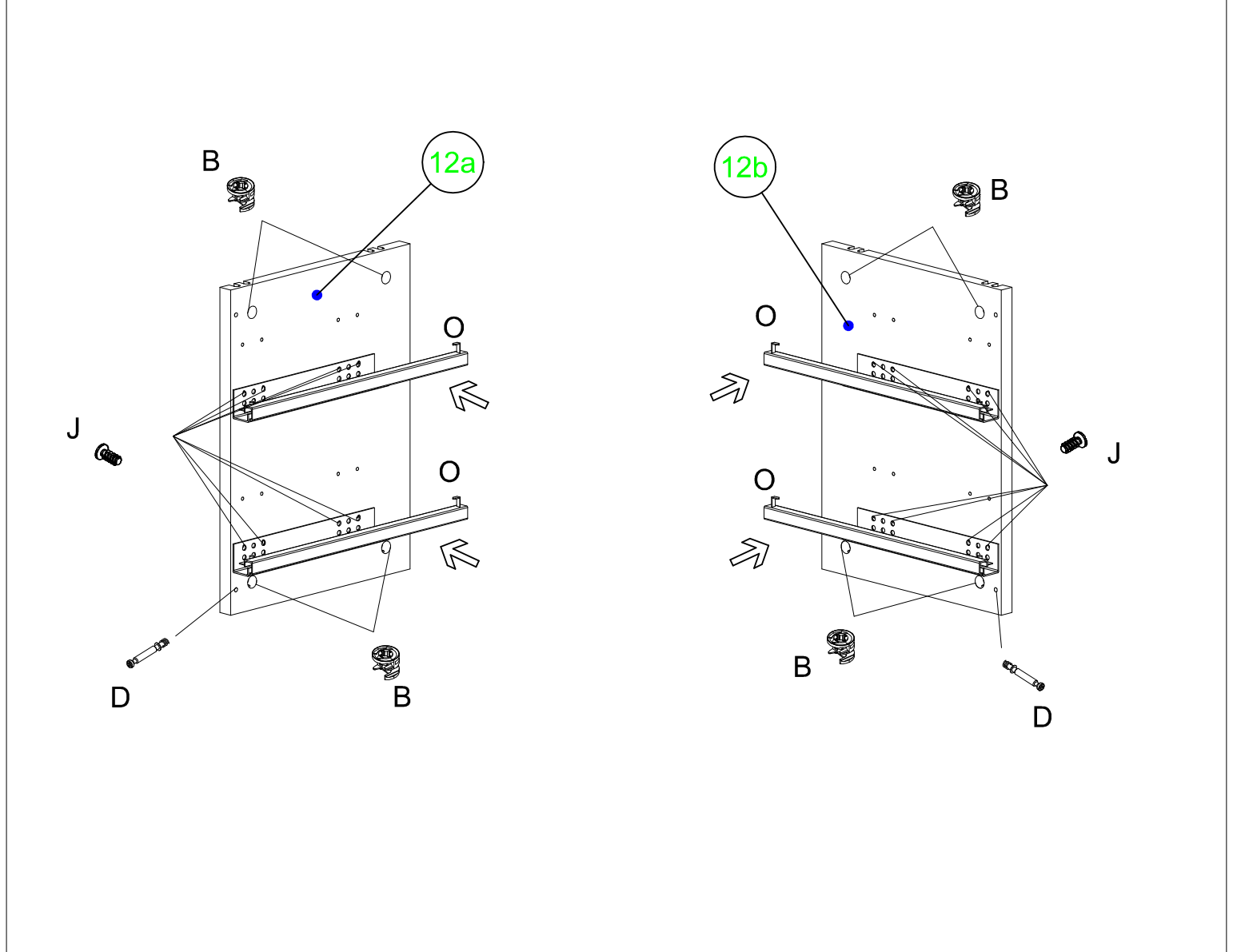

IX

B	D	J	O
10	2	Ø 5x13 16	4

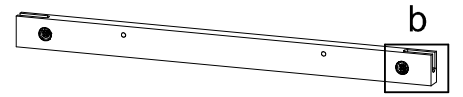

Ausnahme!
Exception!
Wyjątek!

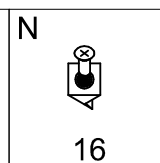
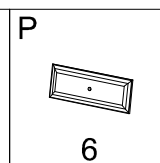
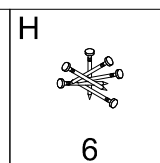
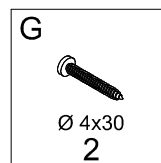
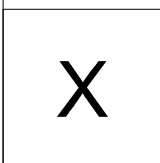
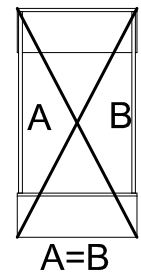
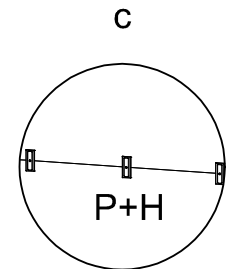
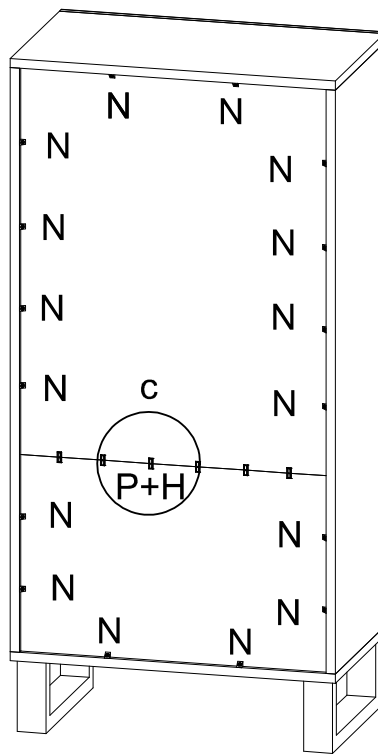
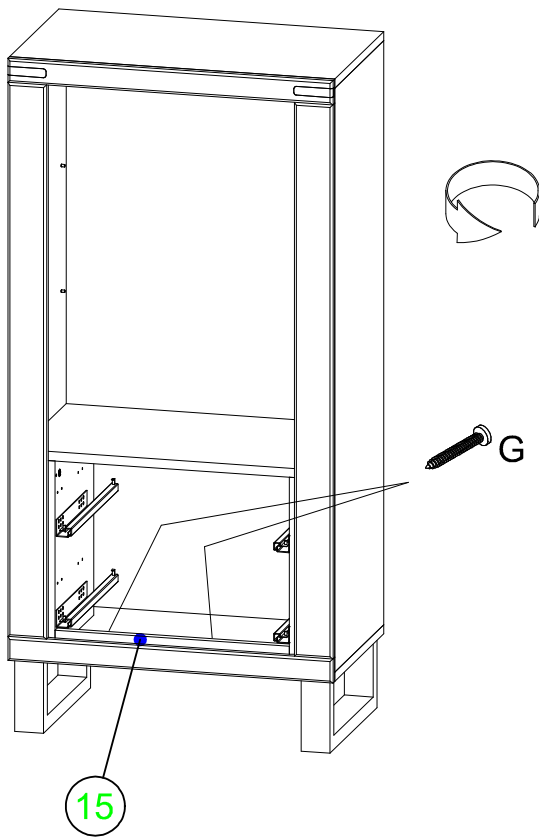
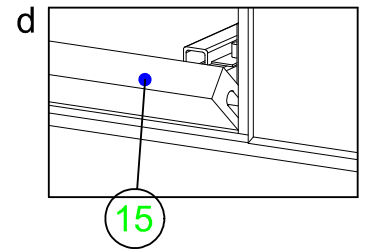
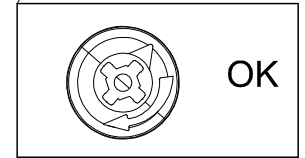
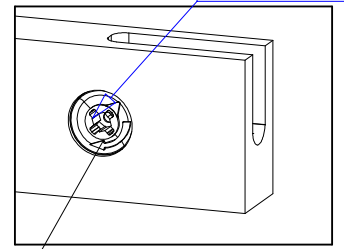
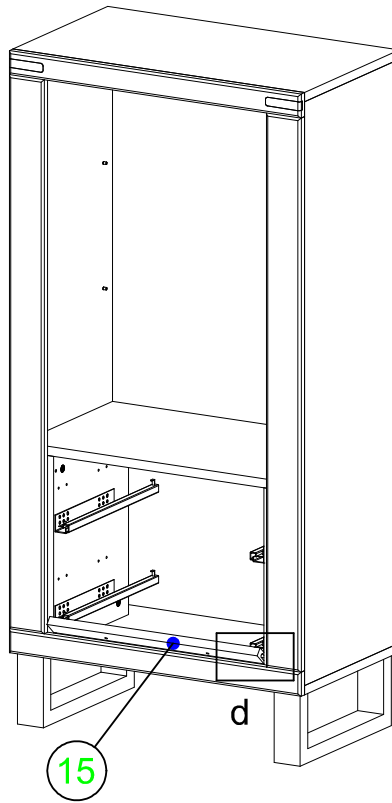
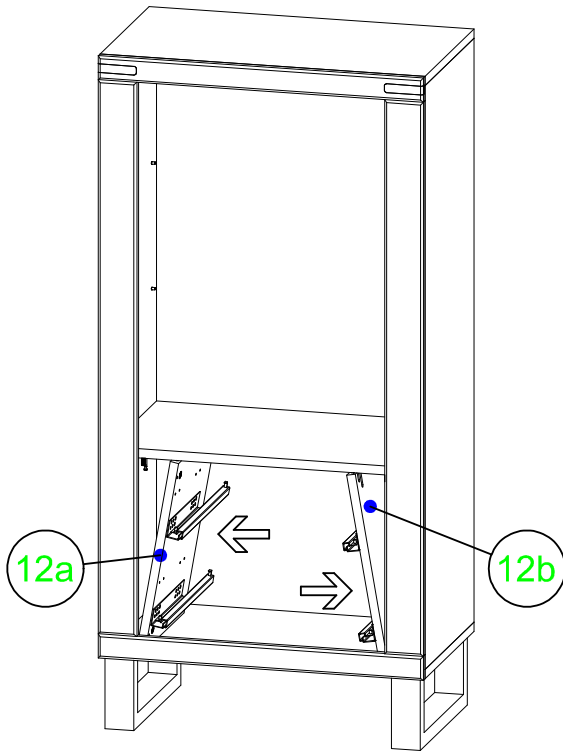

XI

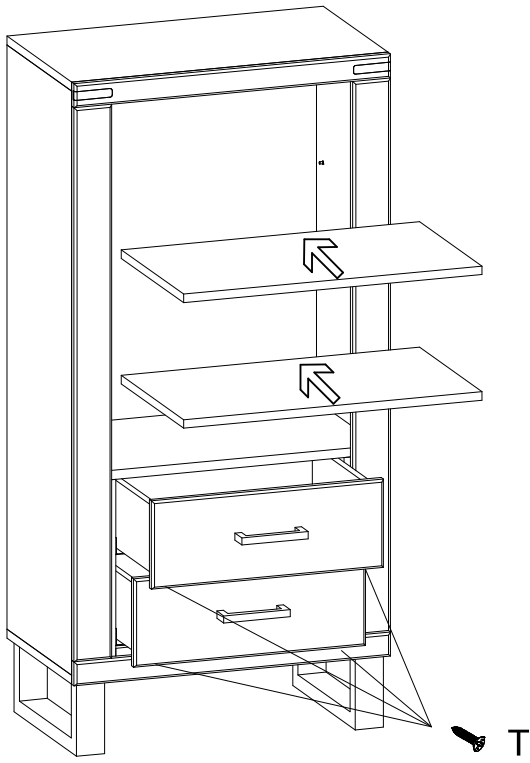

T

T



Ø 3x16
4

XII

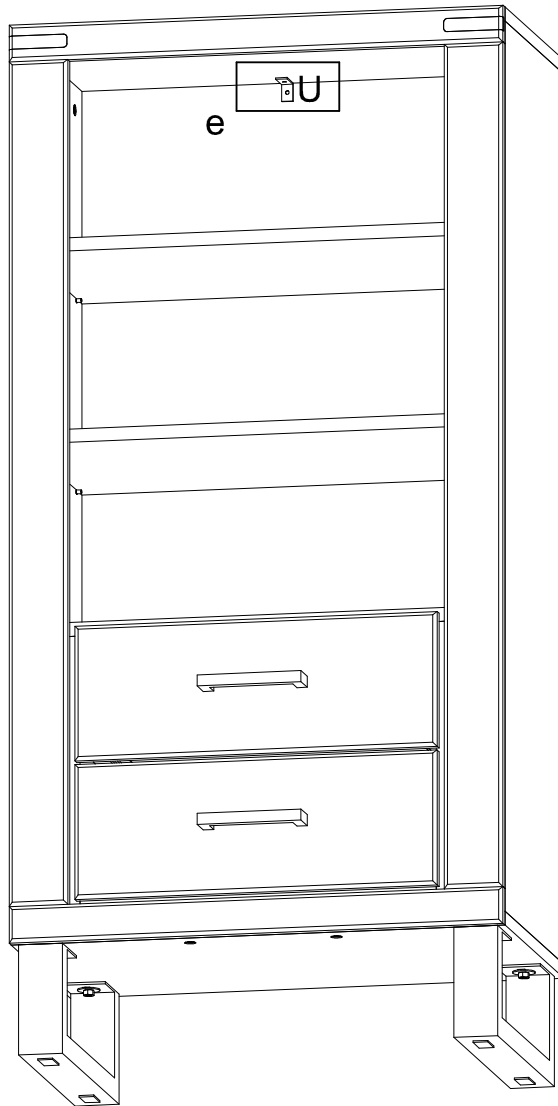

e

U

e

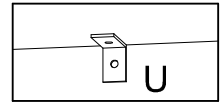

U

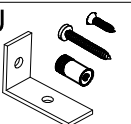

1