

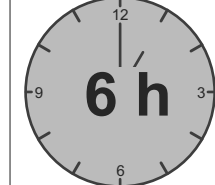

- (GB) Assembly instructions
- (DE) Montageanleitung
- (FR) Notice de montage
- (NL) Handleiding voor de montage
- (IT) Istruzioni di montaggio
- (HU) Szerelési útmutató
- (ES) Instrucciones de montaje
- (PL) Instrukcja montażu
- (CZ) Montážní návod
- (SK) Návod na montáž
- (HR) Montat'e
- (TR) Montaj talimat
- (RO) Instrucțiuni de montaj
- (RU) Инструкции по монтажу

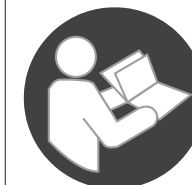
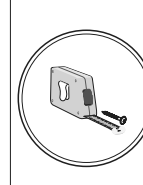
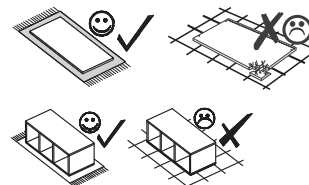
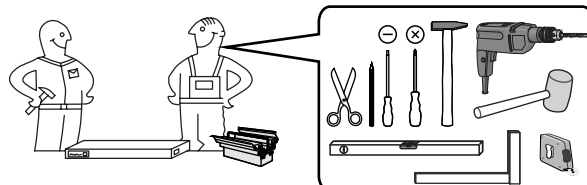
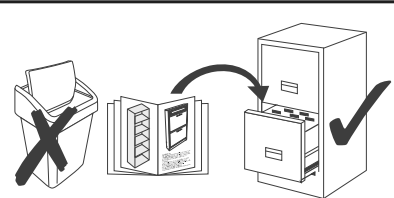
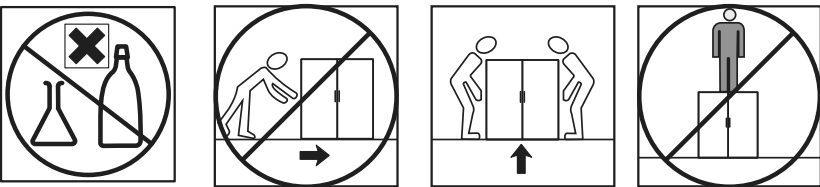
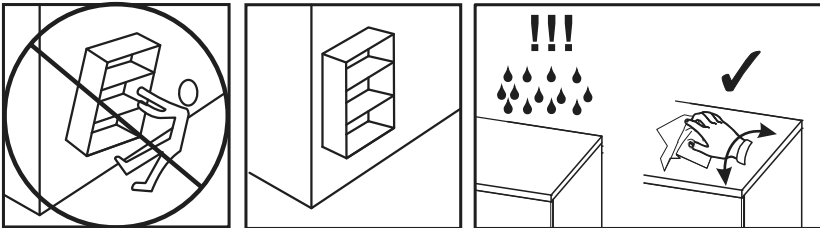
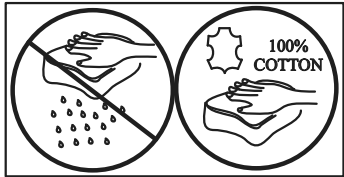
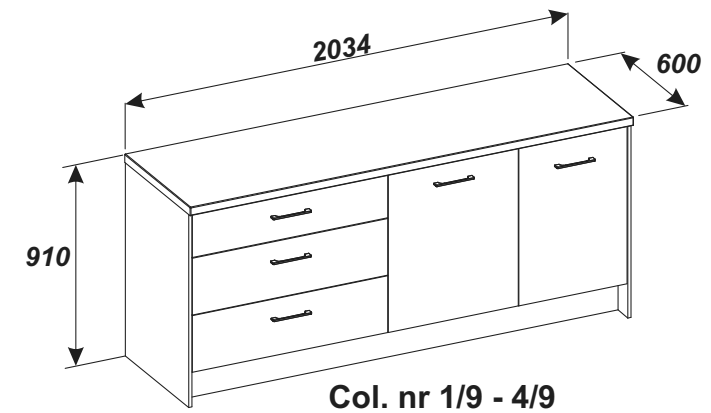
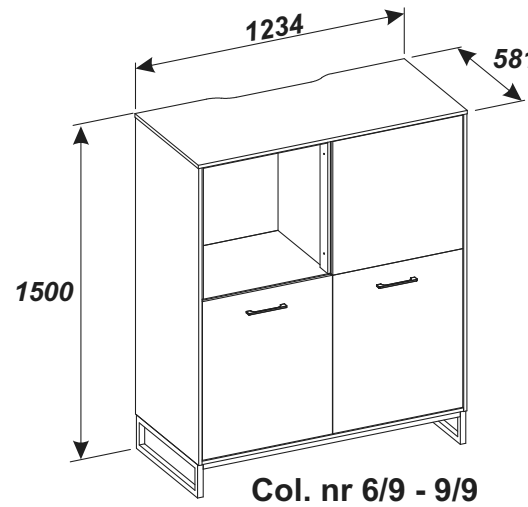
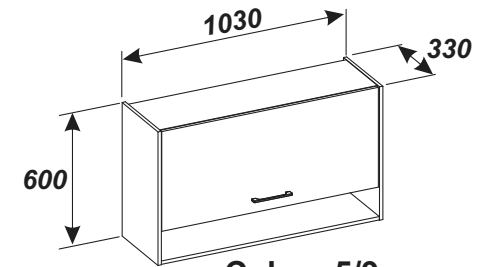
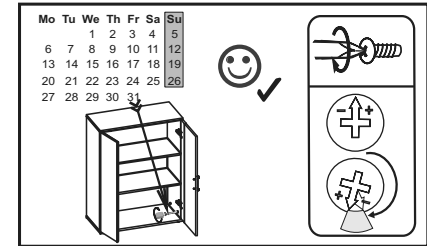

Service • Assistenza • Dienstverlening • Serwis Servis • Szerviz • Servizio • Usluga •

Name • Nom • Nome • Naam • Nazwa
Jméno • Názov • Név • Denumire
Nombre • Ime • Isim

MONTREAL

shop • geschäft • boutique • sklep • winkel •
negozio • bolt • tienda • obchod • dučan • mađaza • magazin

Nr. • No. • N° • říeříd • Ć • Sz • Ne



Typ • Type • Tip • Típus • Tipo

2D

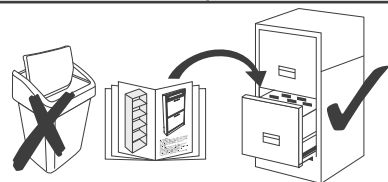

M1 15x12,5 x26	J23 x9	P4 4x25 x6
-----------------------------	------------------	-------------------------

T1 x26	F1 x5	N31 x1
------------------	-----------------	------------------

C9 fi 20 x31	P2 3x16 x14	S8 4x13 x4
---------------------------	--------------------------	-------------------------

L13 SJ x4	W1 x4	I20 x2
------------------------	-----------------	------------------

B1 fi 8x28 x30	J11 x2	S3 3,5x13 x8
-----------------------------	------------------	---------------------------

Z1 x3	P16 4x16 x4	C15 x1
-----------------	--------------------------	------------------

Z2 x2	T17 x2	F30 x4
-----------------	------------------	------------------

S9 4x16 x10	U70 x2	P11 4x13 x16
--------------------------	------------------	---------------------------

D1 H=2 x5	A14 M4x22 x4	S12 4x30 x7
------------------------	---------------------------	--------------------------

Col. nr 6/9

Col. nr 9/9

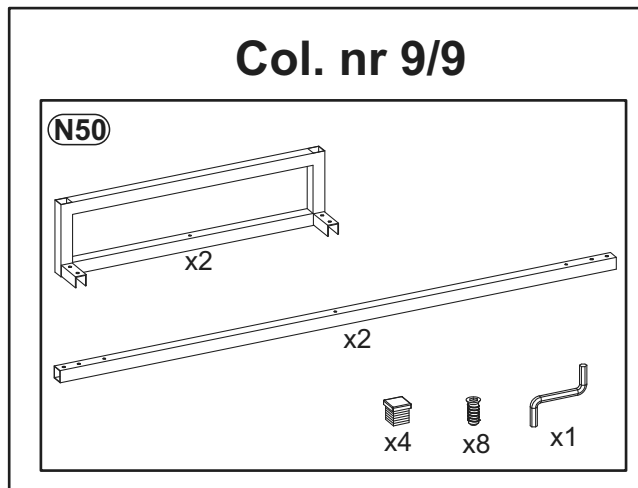

Col. nr 6/9-9/9

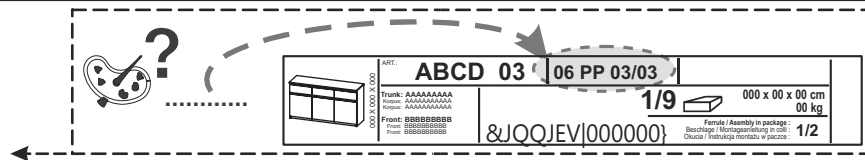
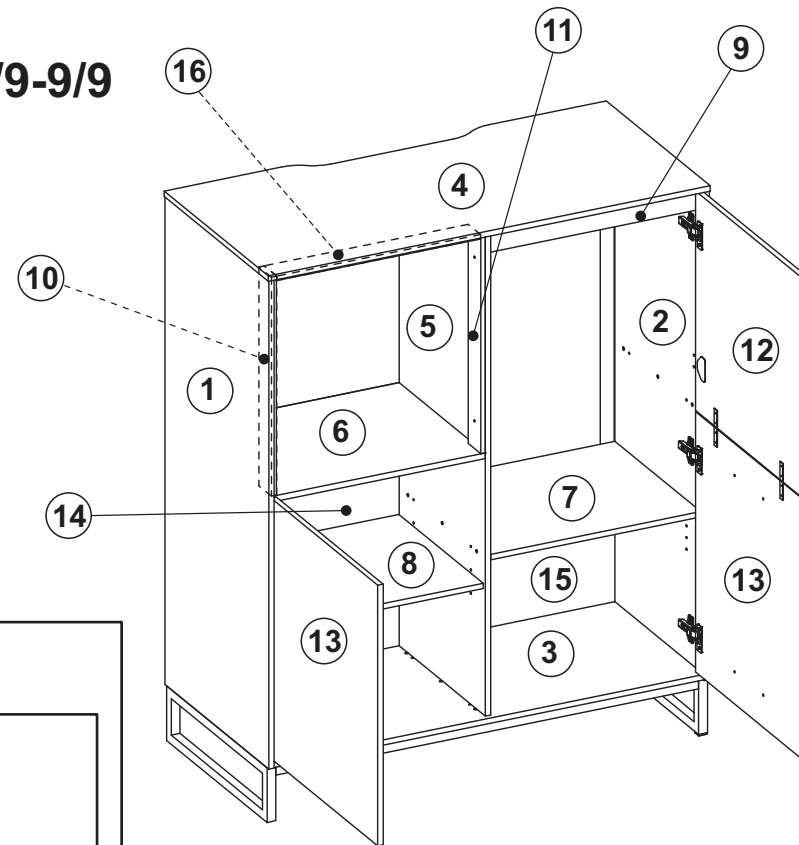

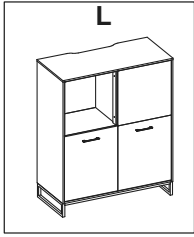

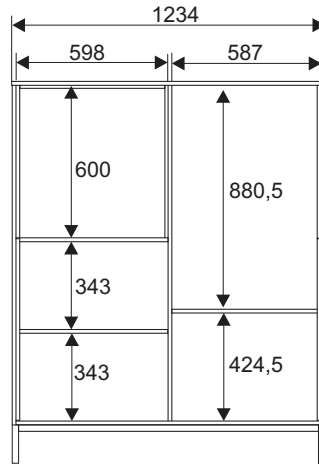
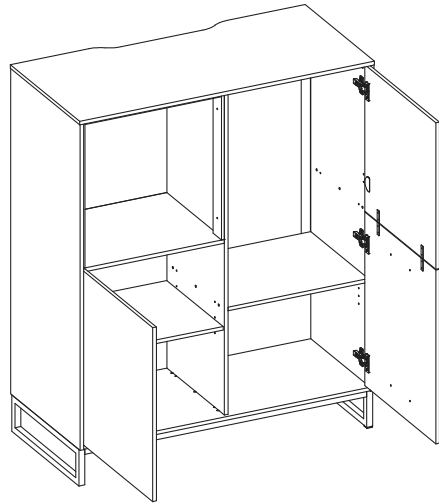

LA

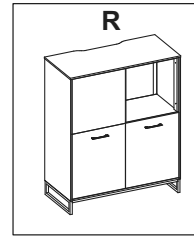

4/68
5/68-11/68



RA

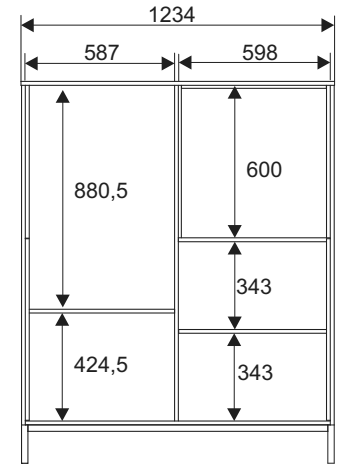
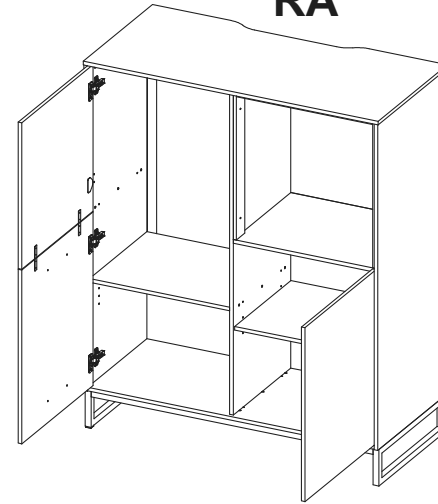

4/68
19/68-25/68

LB

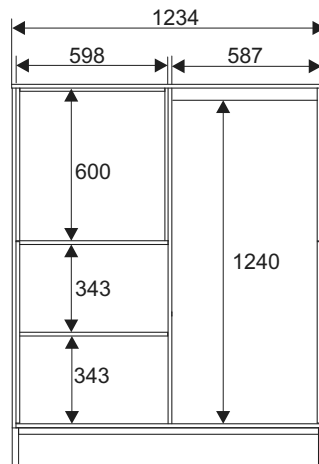
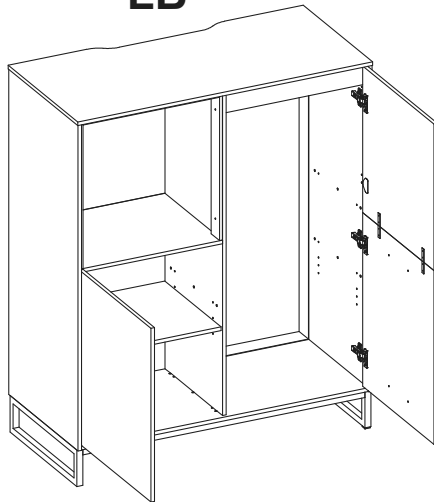

4/68
12/68-18/68

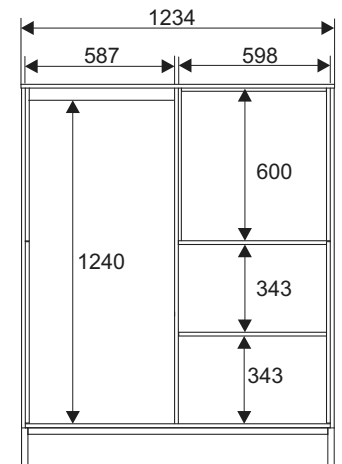
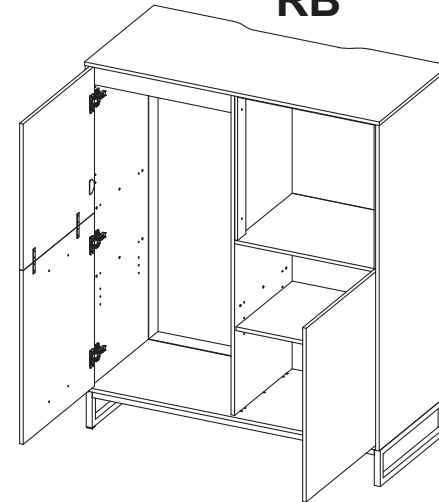

RB

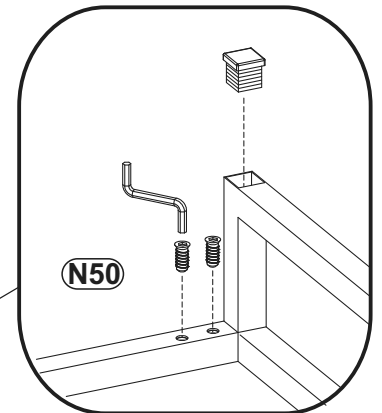
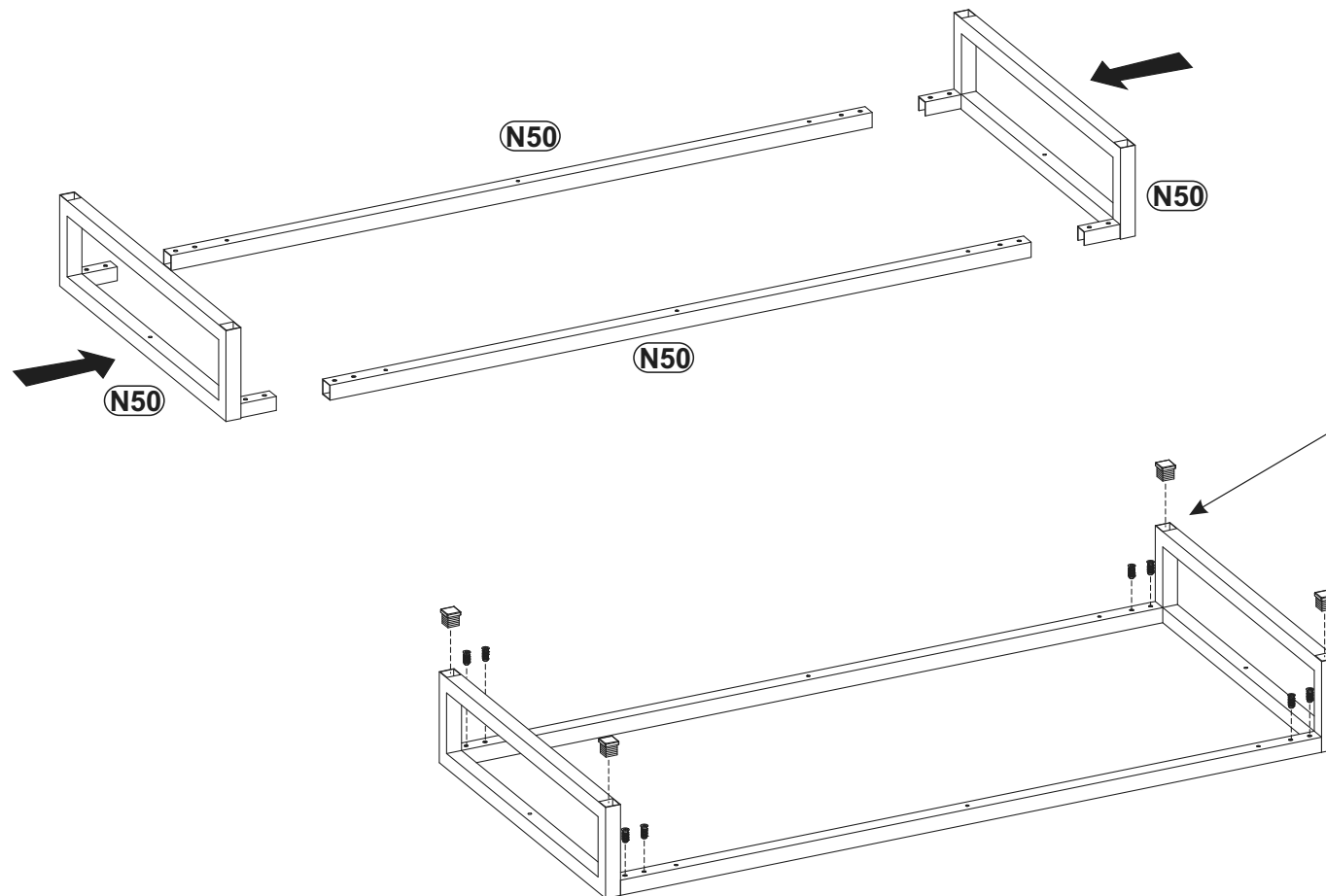
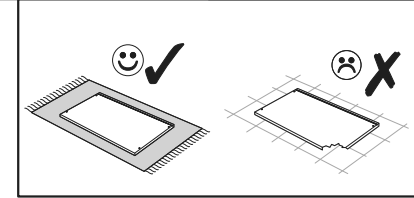
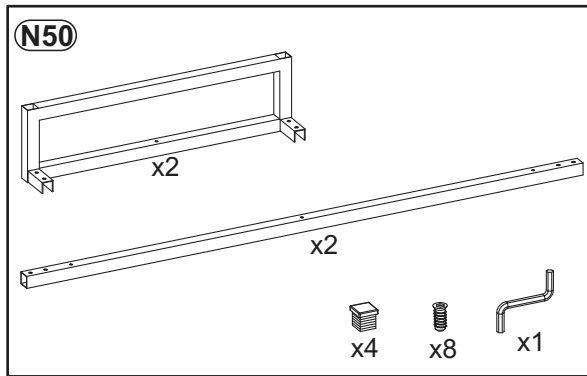

4/68
26/68-32/68

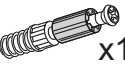

1

- T1**  x12
- B1**  fi 8x28 x12
- D1**  H=2 x5

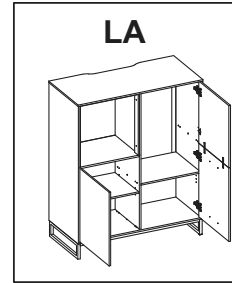

5/68 - 11/68

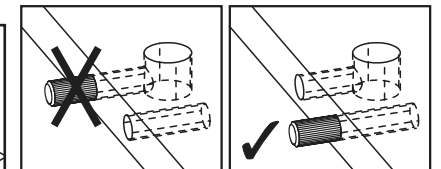
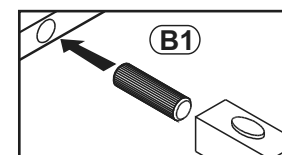
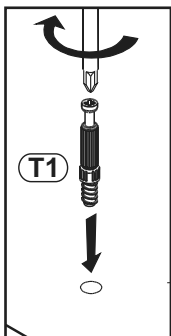
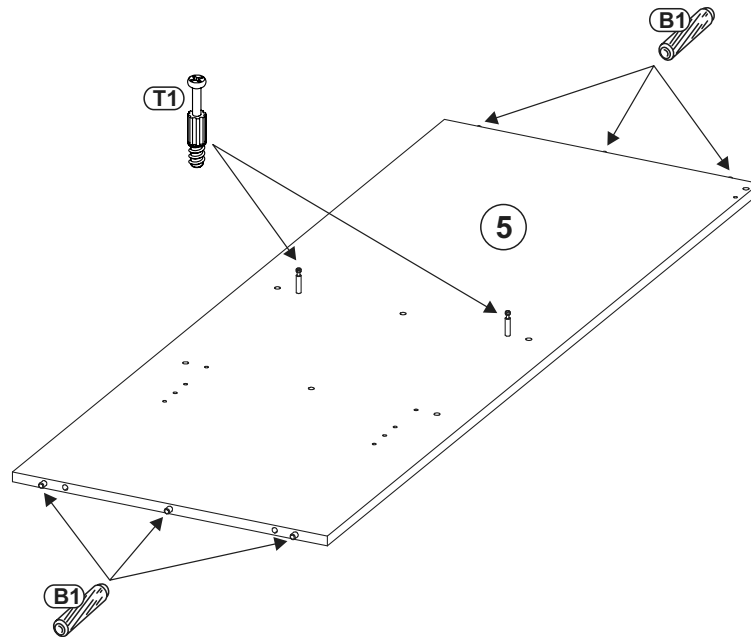
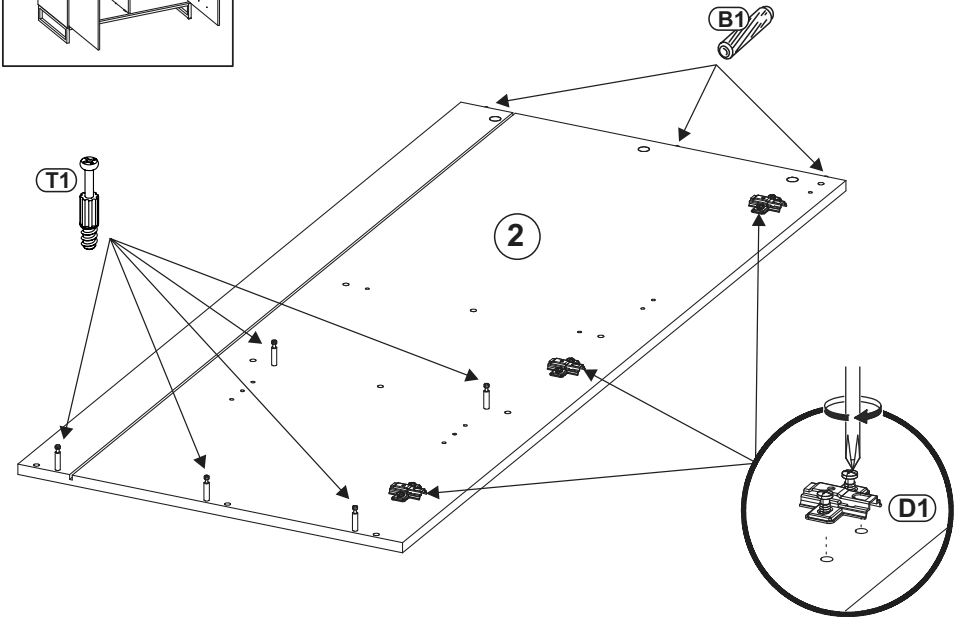
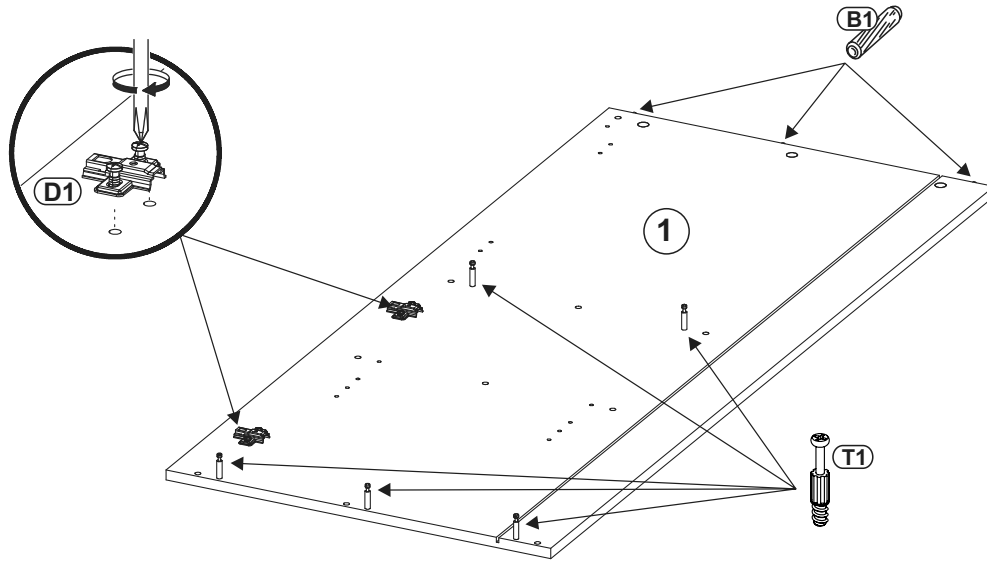
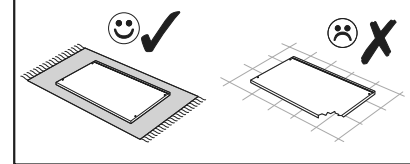

2

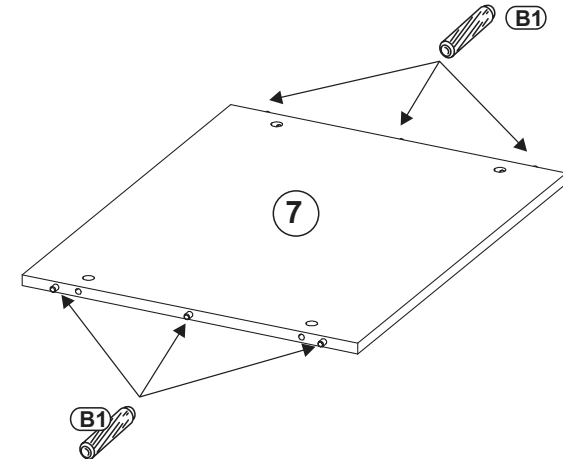
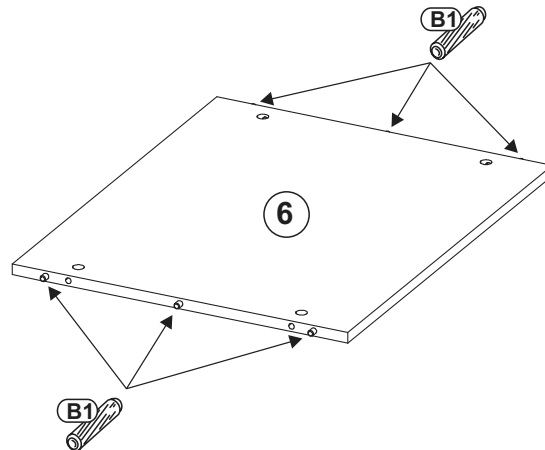
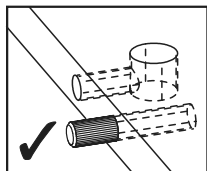
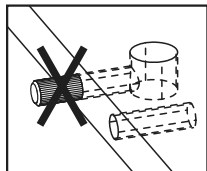
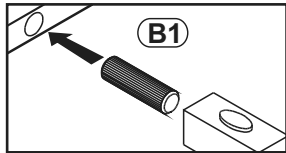
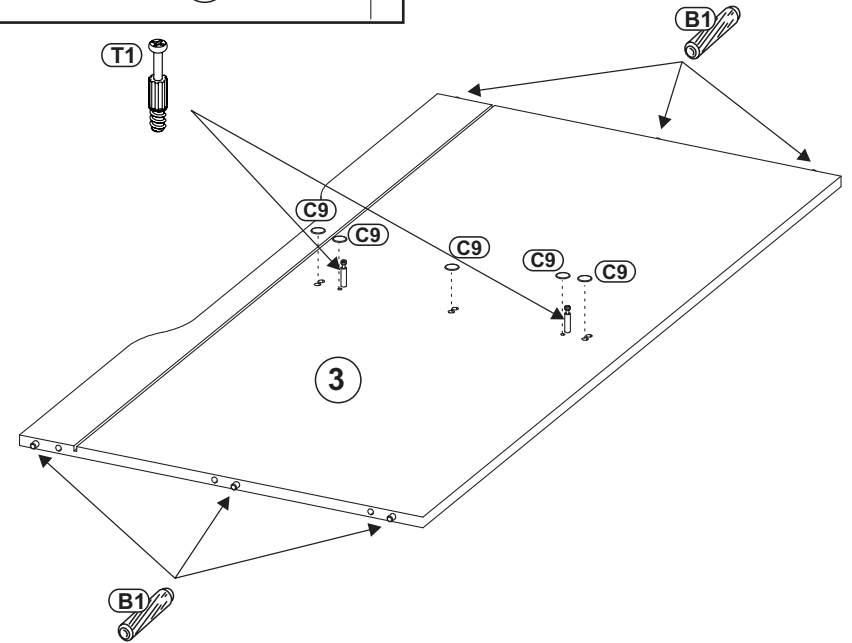
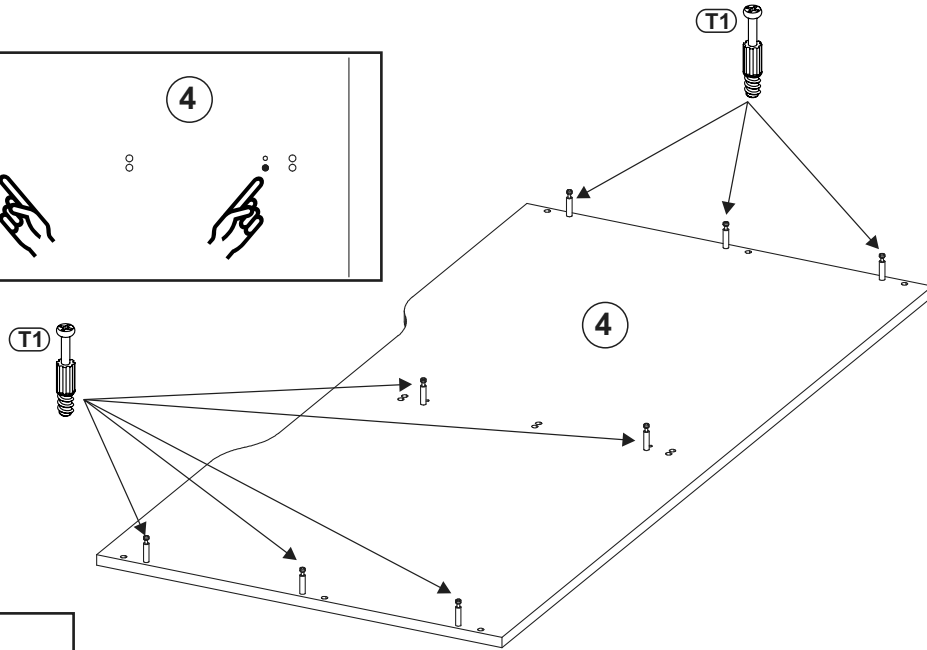
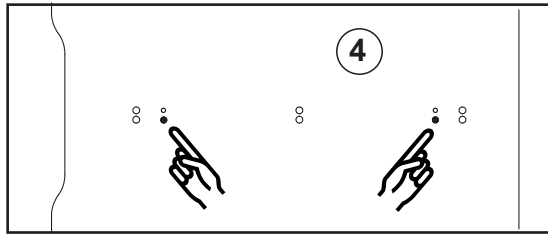
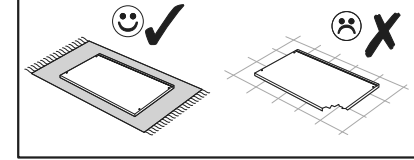
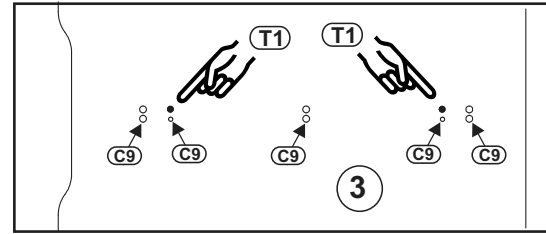
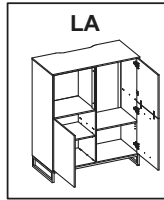
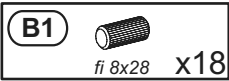
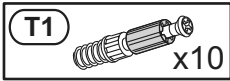

3

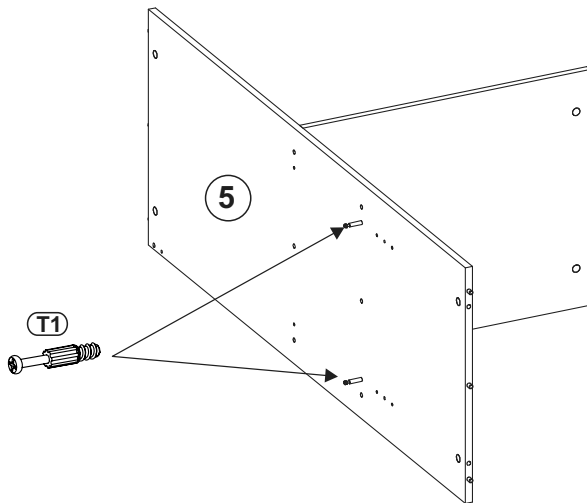
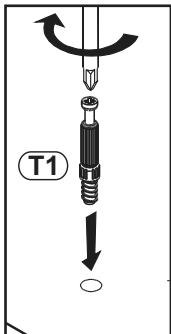
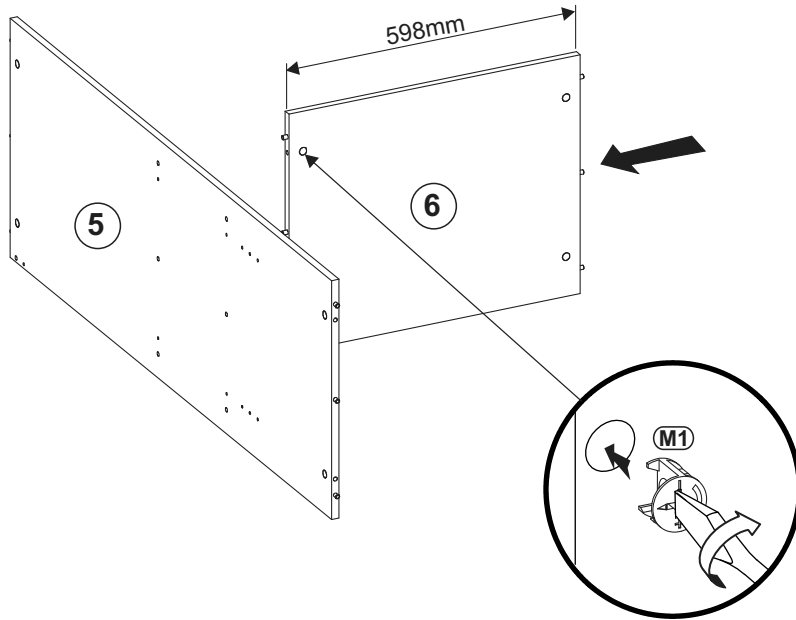
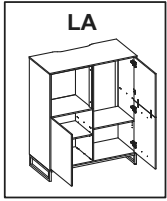
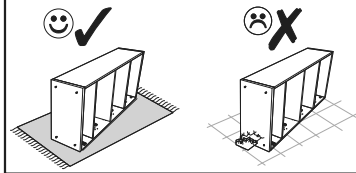
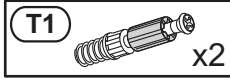

4

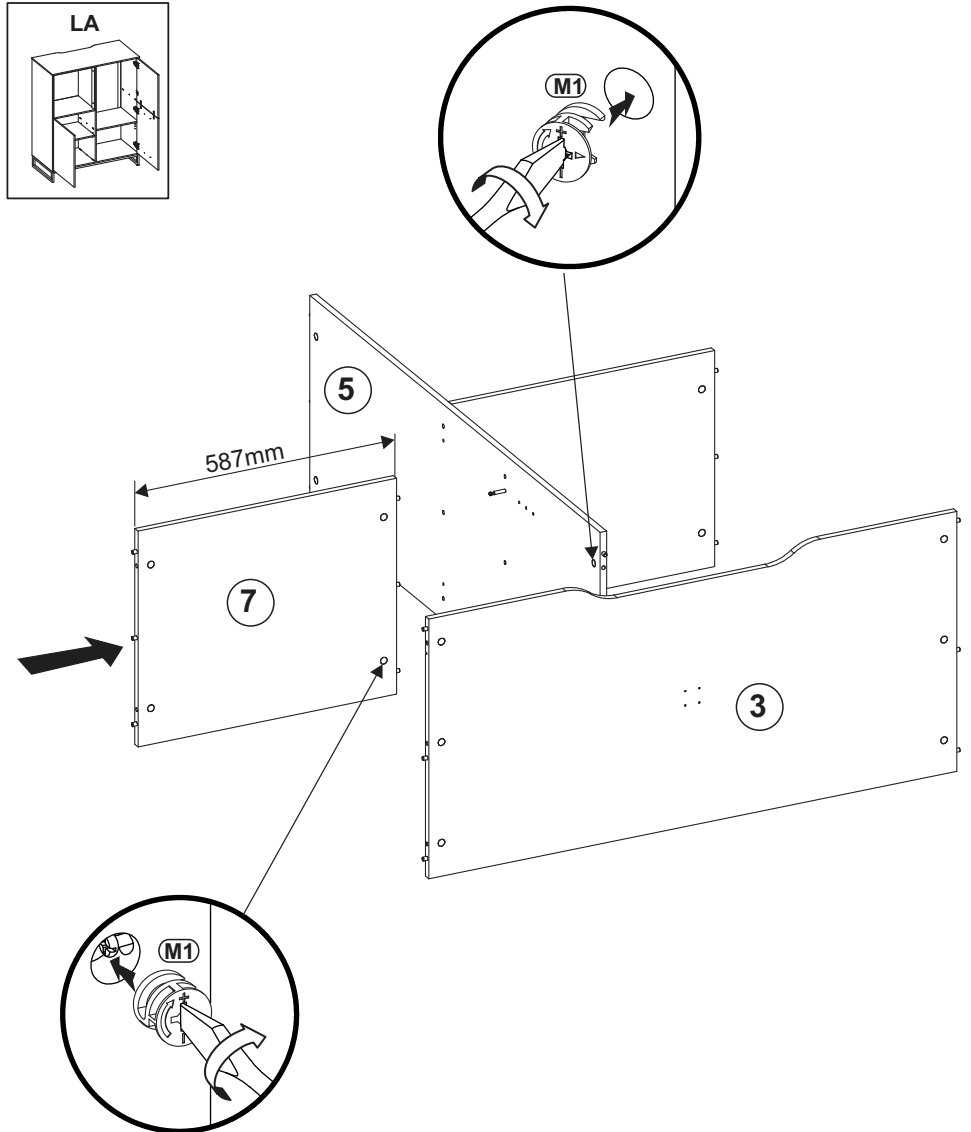
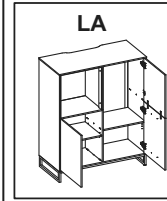
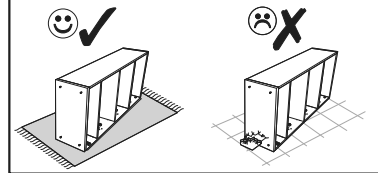

5

M1  x10

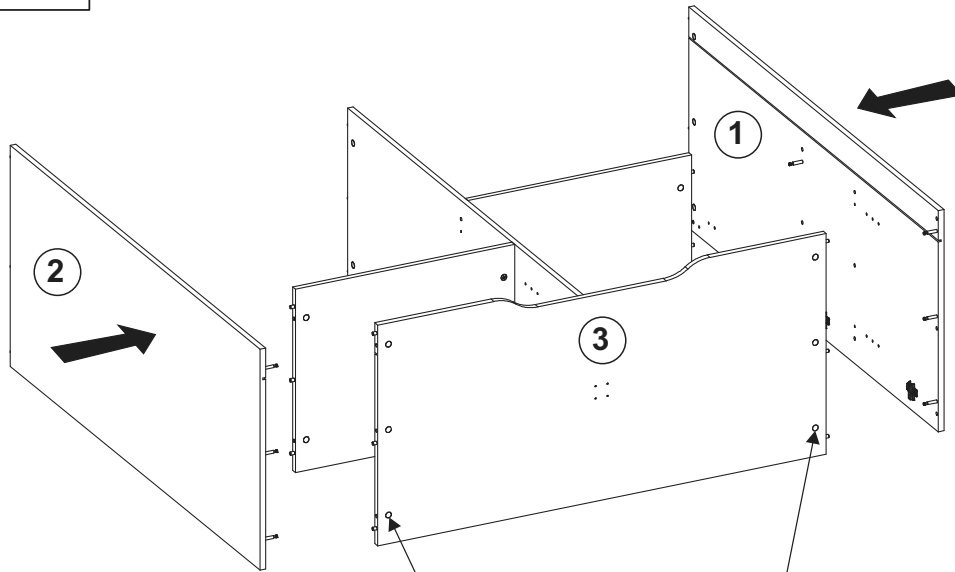
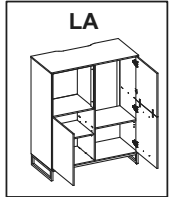
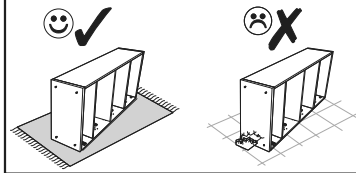

6

M1  x8

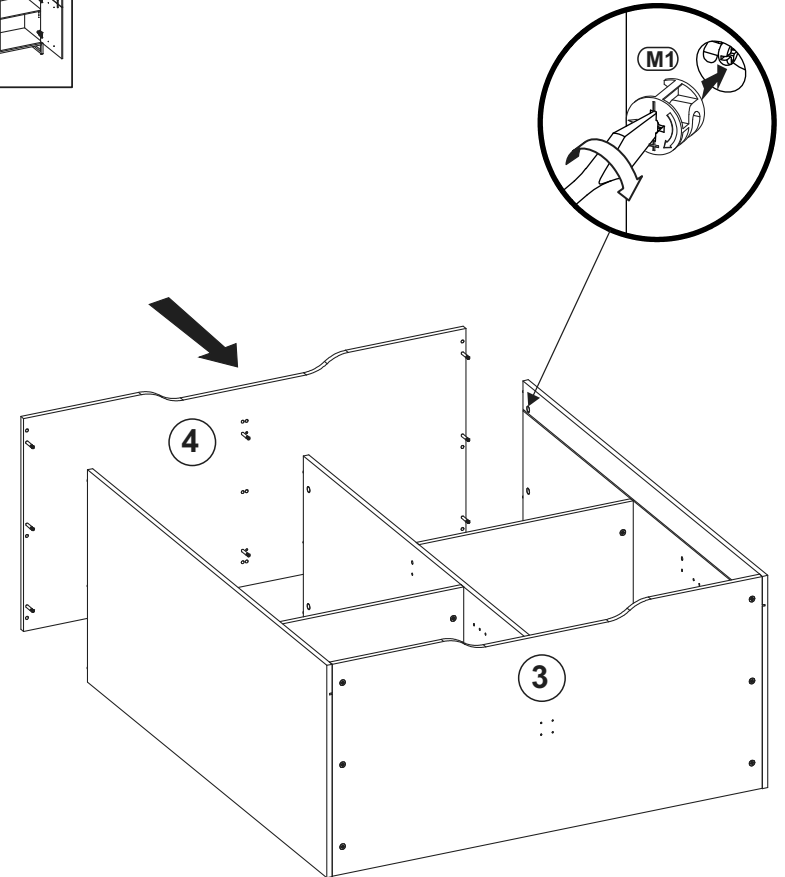
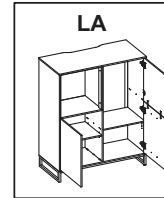
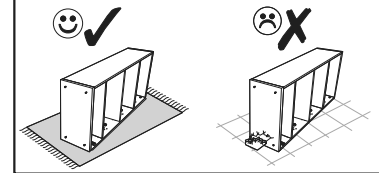

7

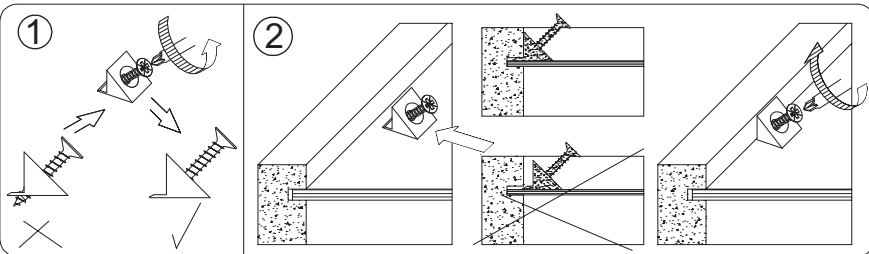
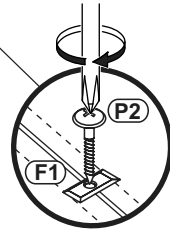
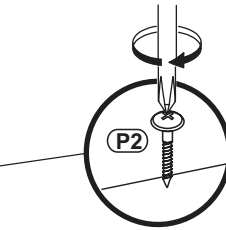
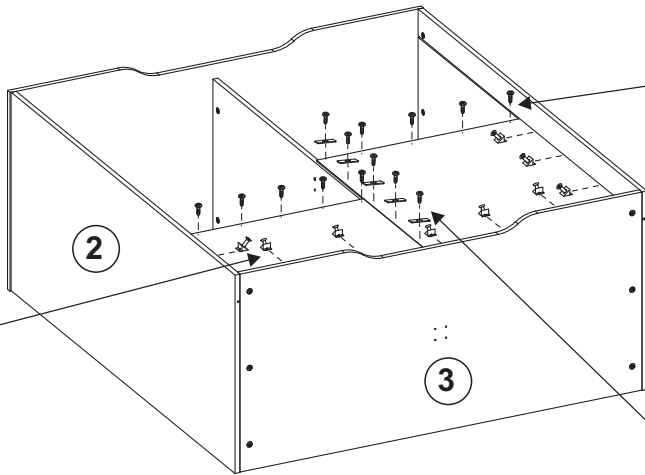
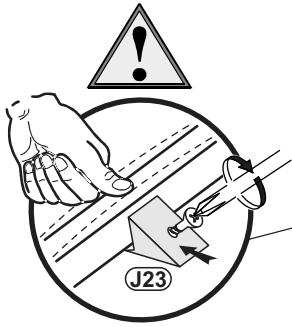
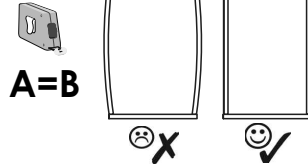
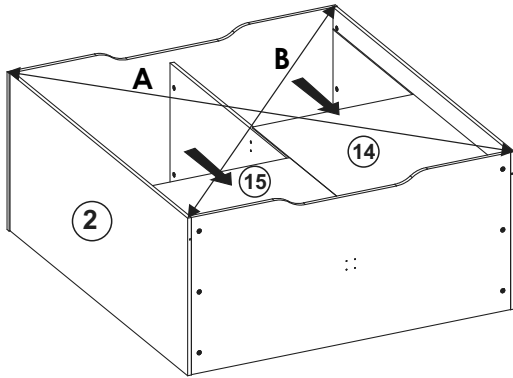
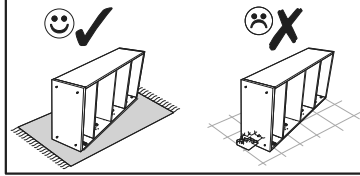
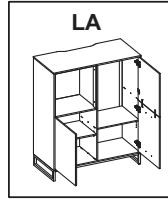
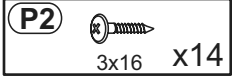
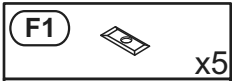

8

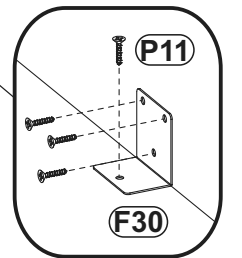
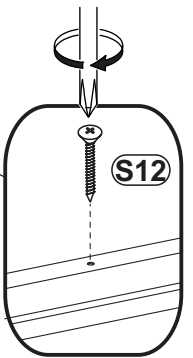
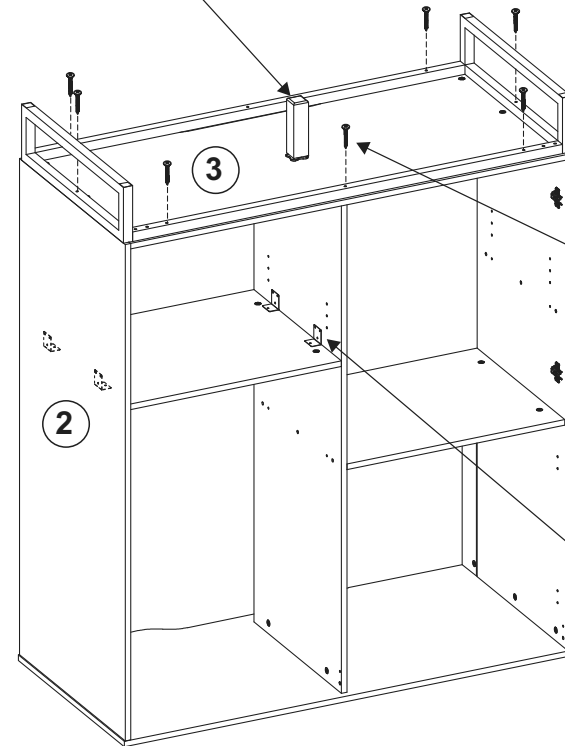
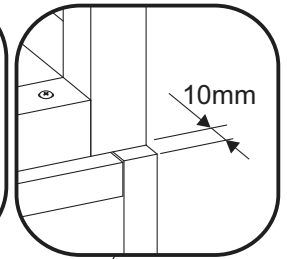
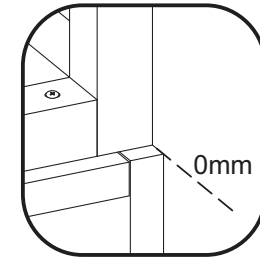
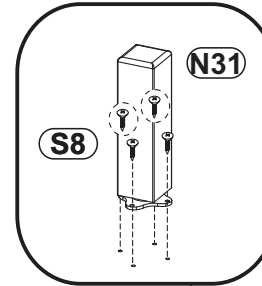
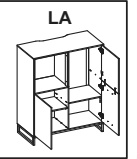
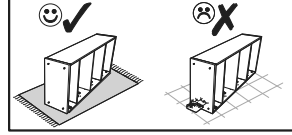
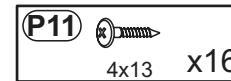
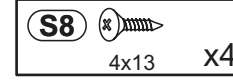
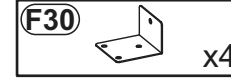
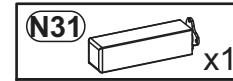

9

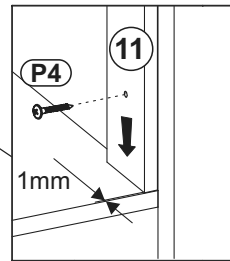
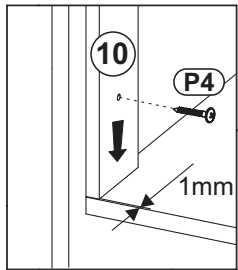
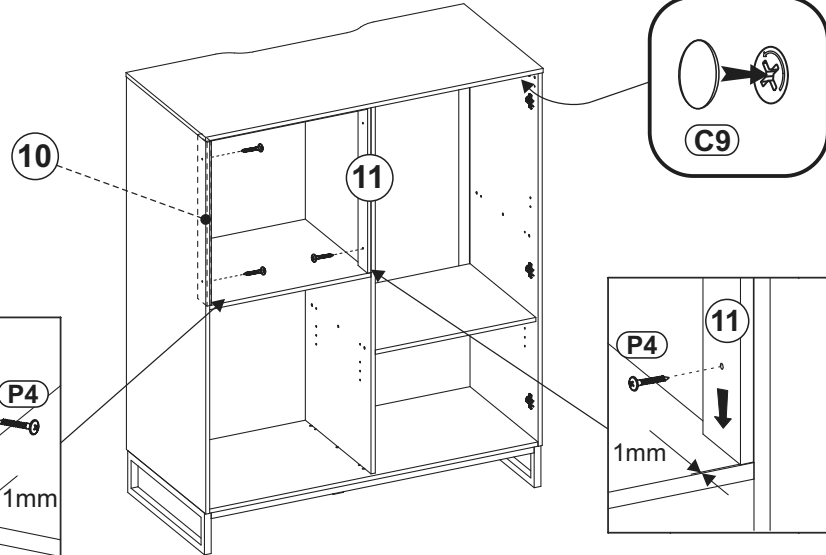
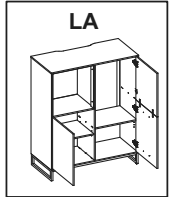
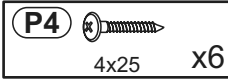



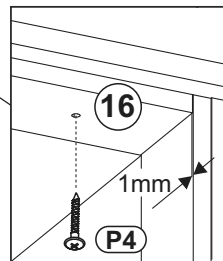
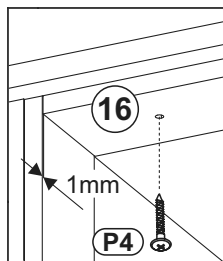
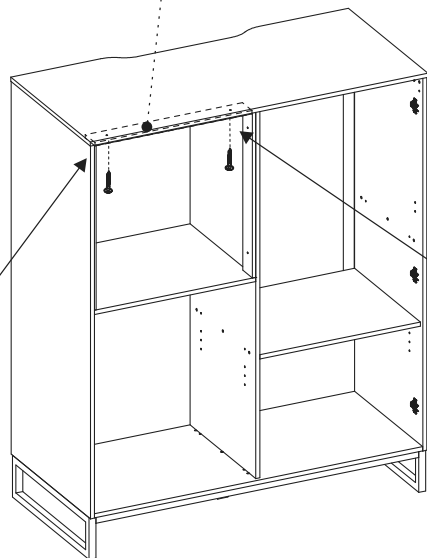

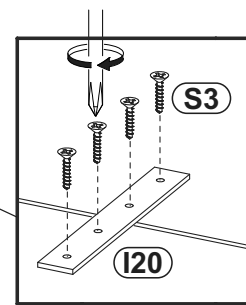
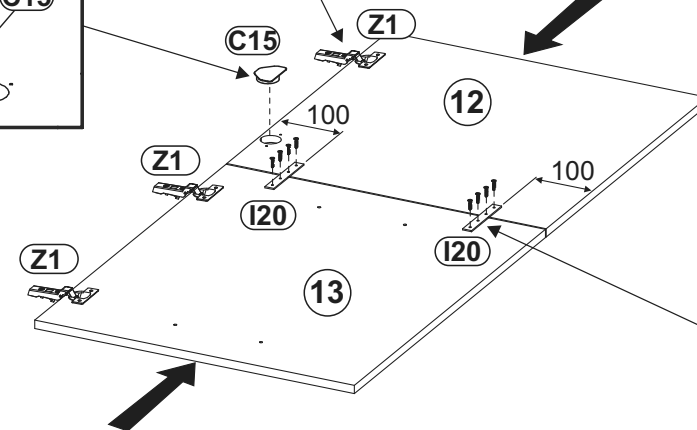
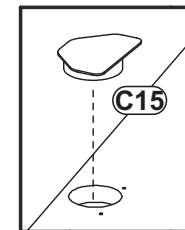
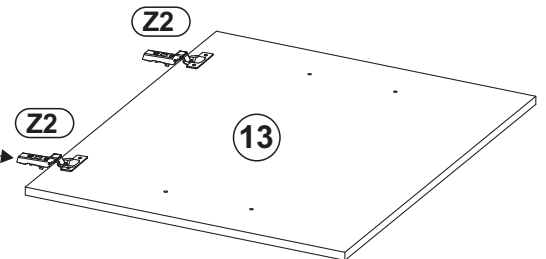
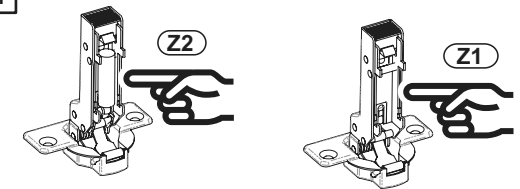
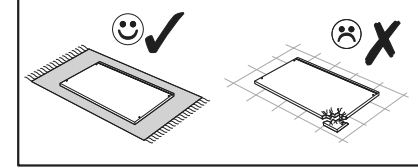
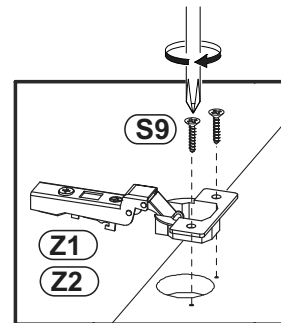
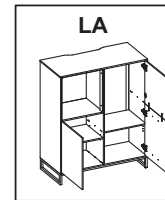
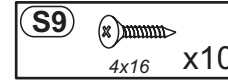
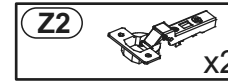
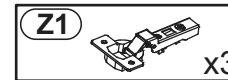
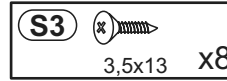
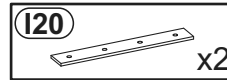

16



10



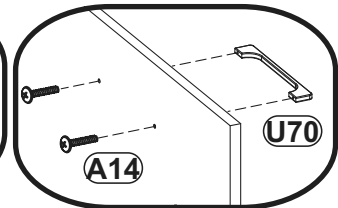
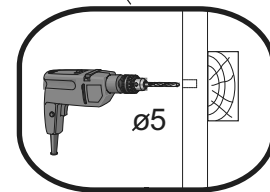
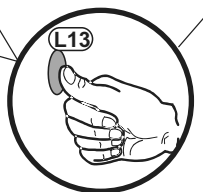
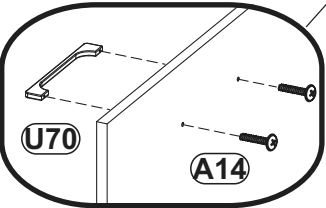
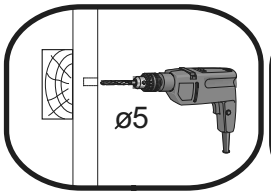
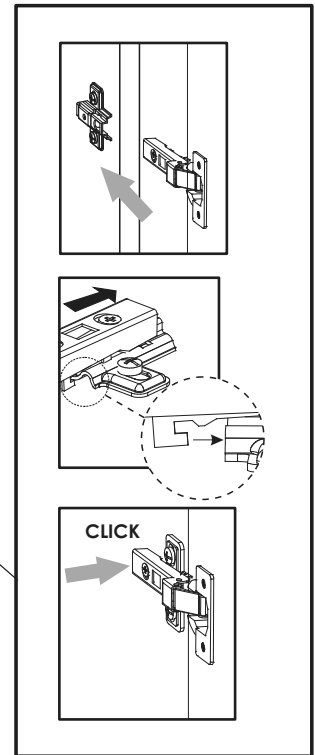
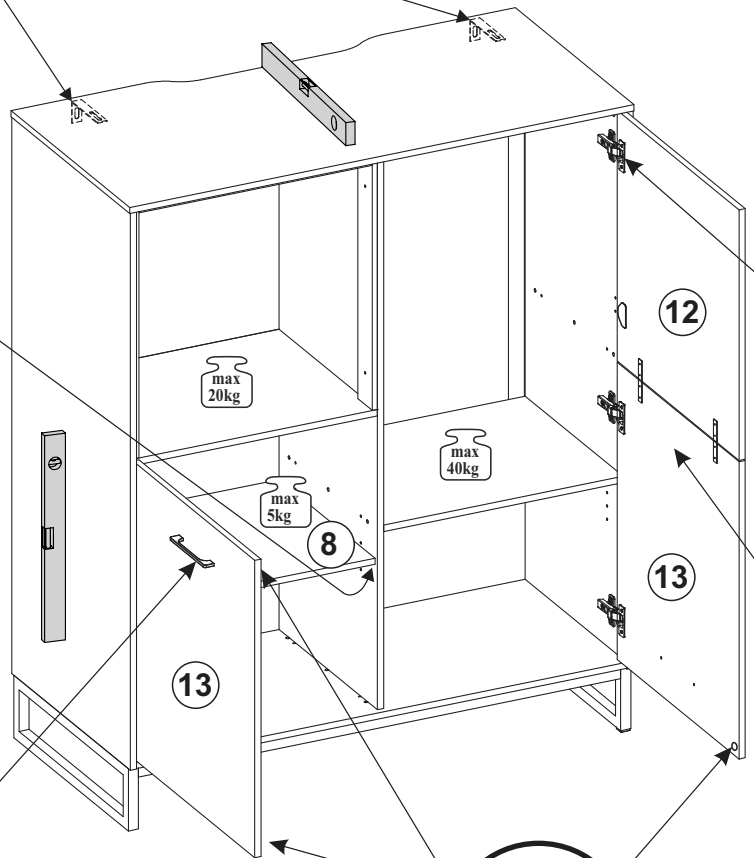
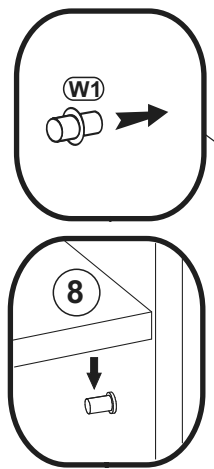
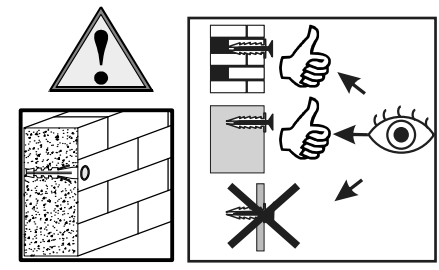
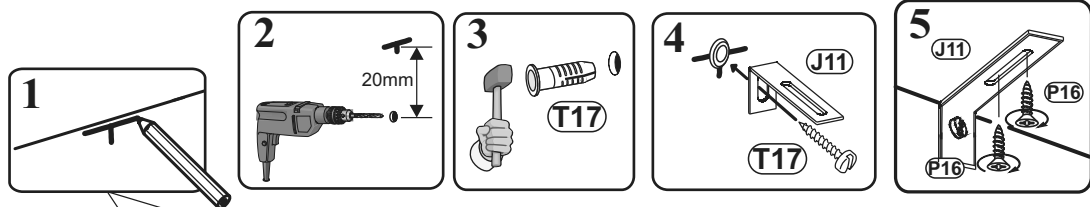
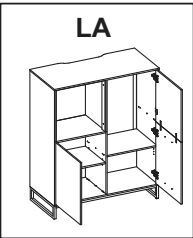

11

- U70**  x2
- A14**  M4x22 x4
- W1**  x4
- L13**  SJ x3
- J11**  x2
- P16**  4x16 x4
- T17**  x2

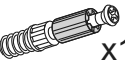

1

- T1**  x11
- B1**  fi 8x28 x12
- D1**  H=2 x5

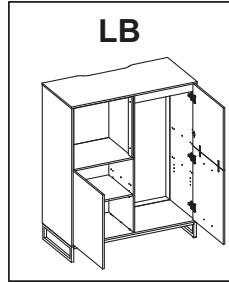

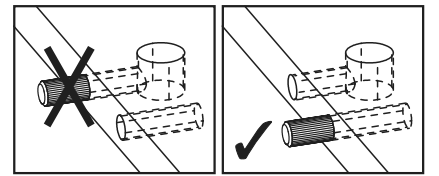
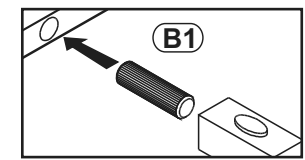
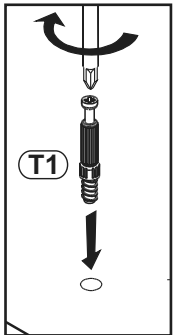
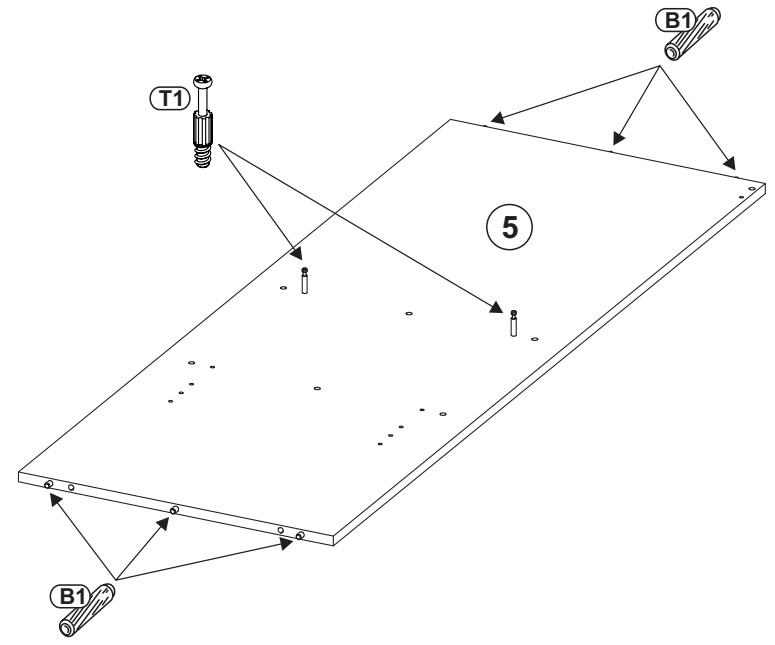
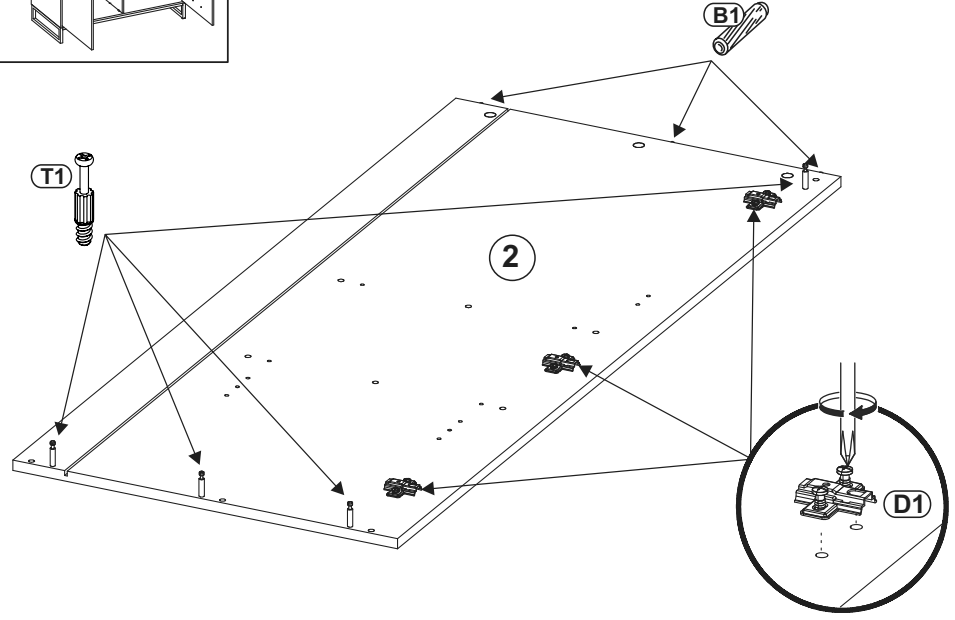
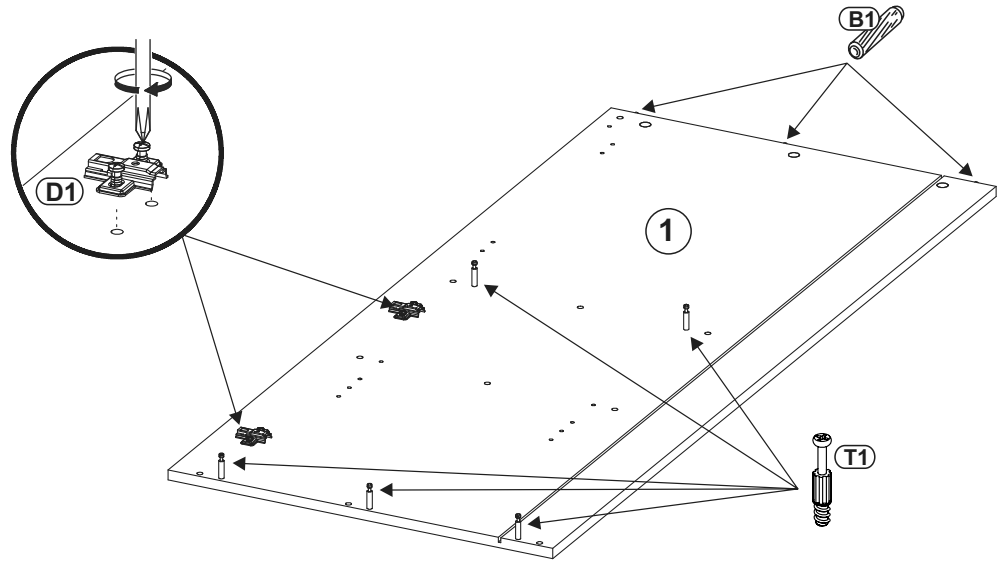
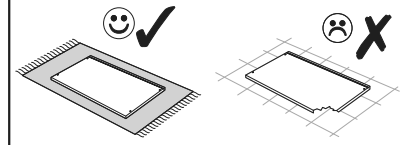

12/68 - 18/68

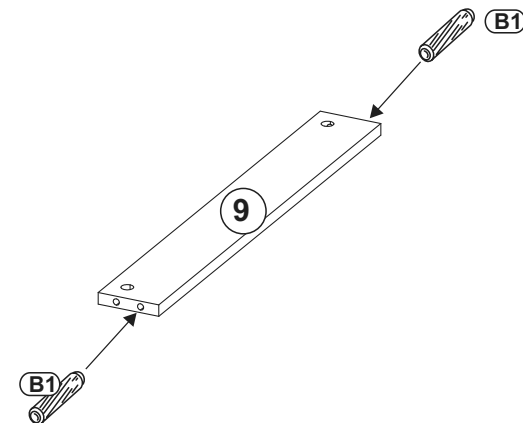
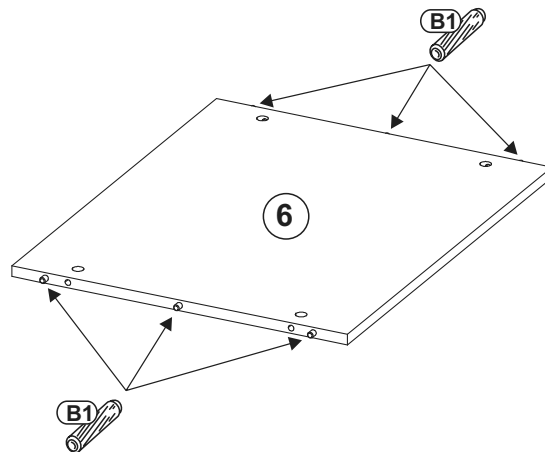
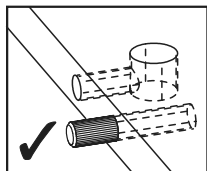
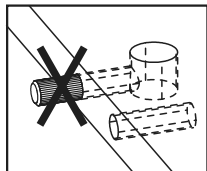
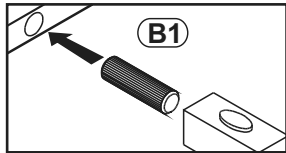
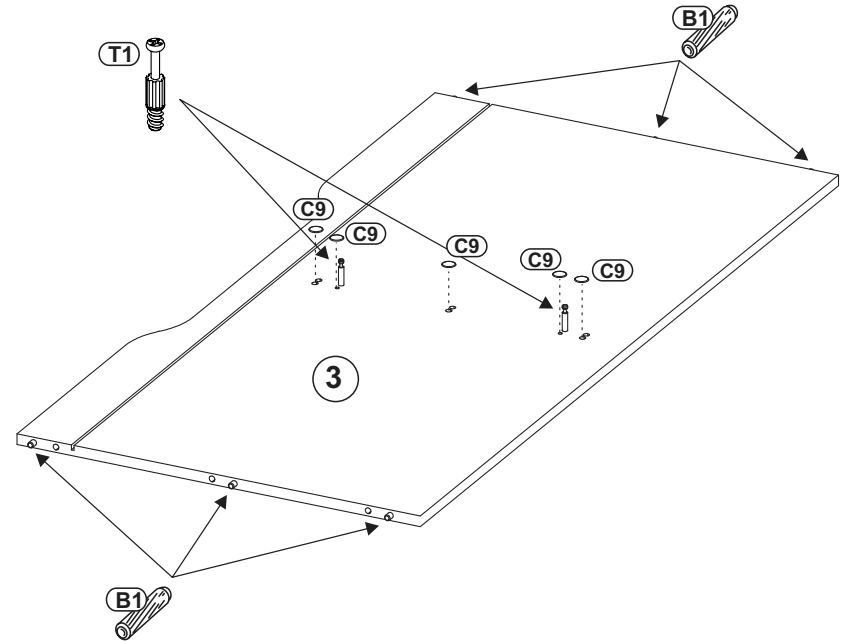
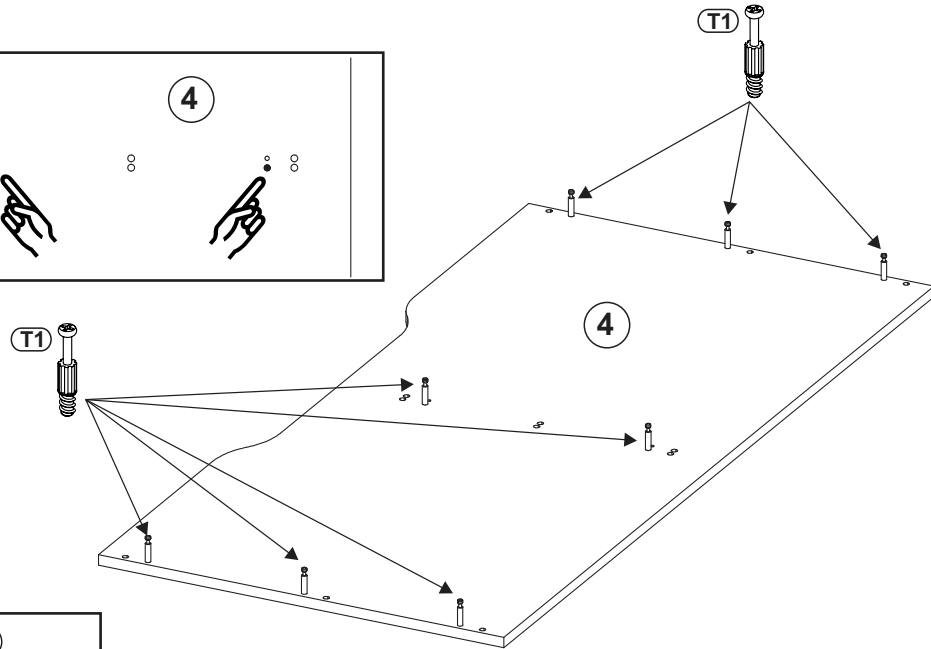
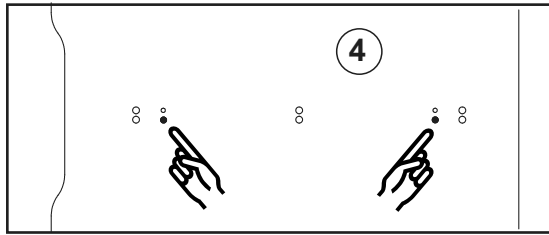
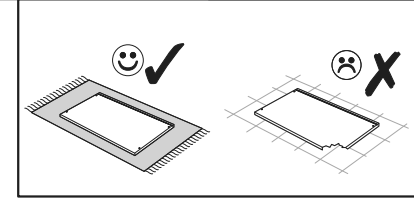
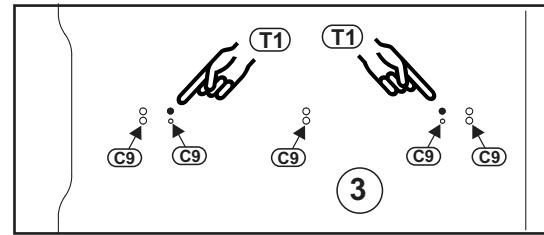
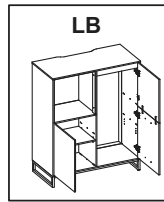
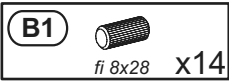
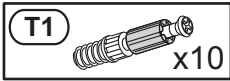

2

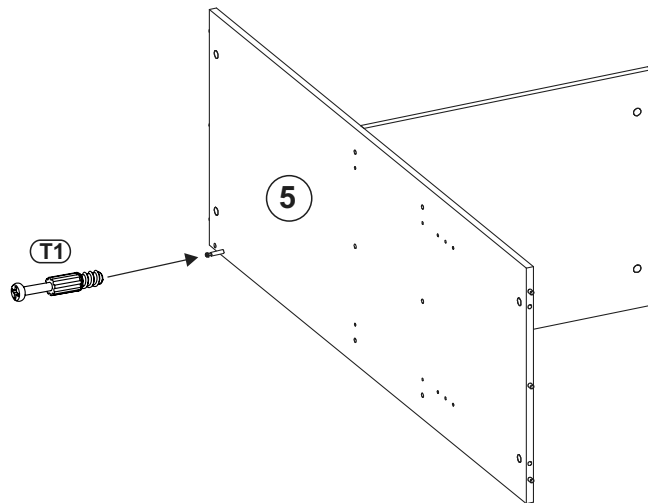
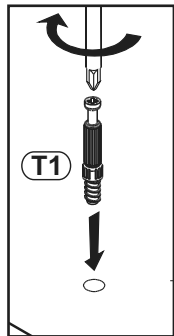
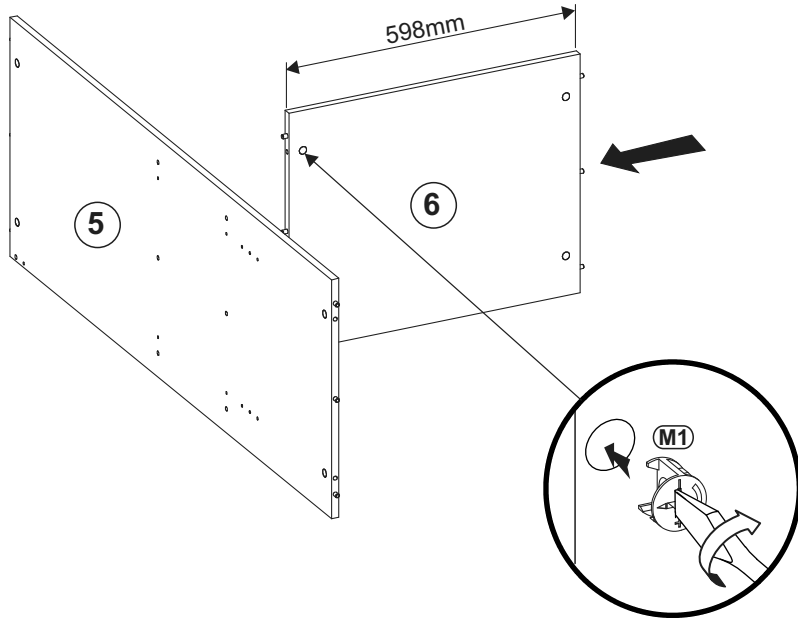
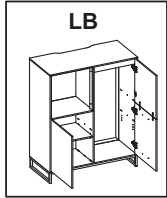
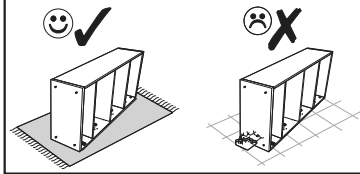
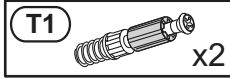

3



4

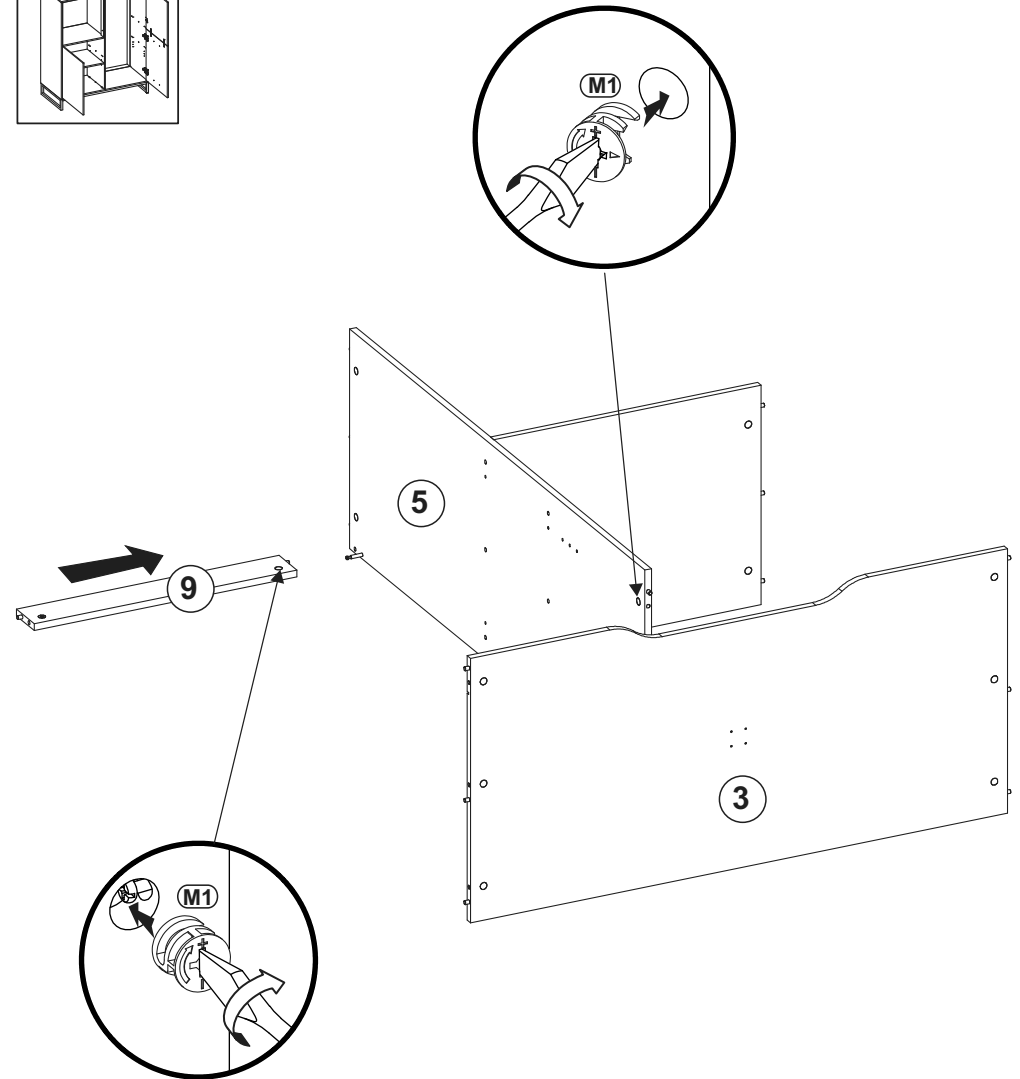
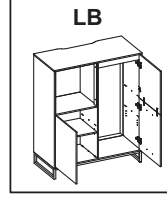
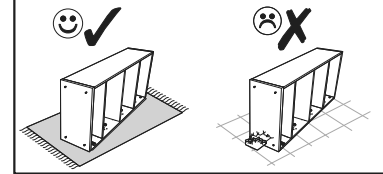

5

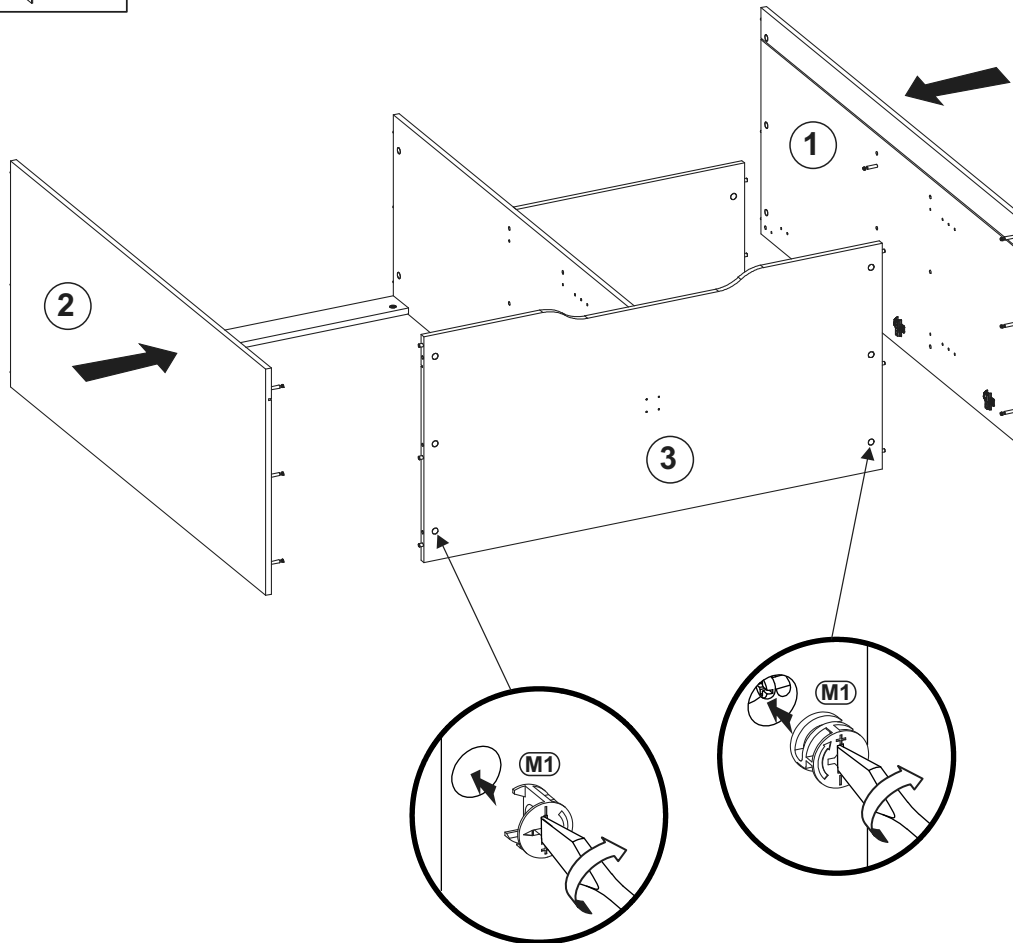
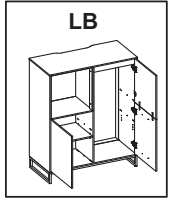
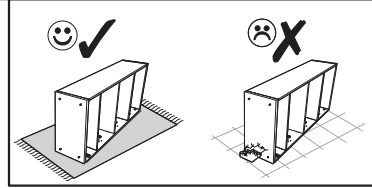

6

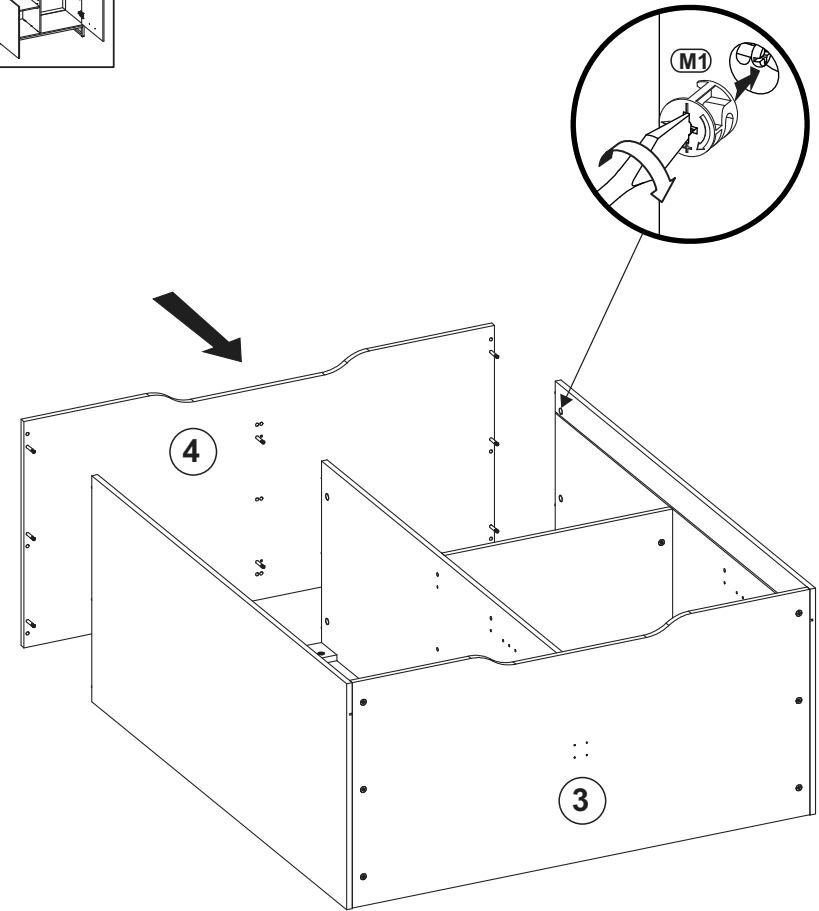
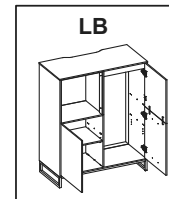
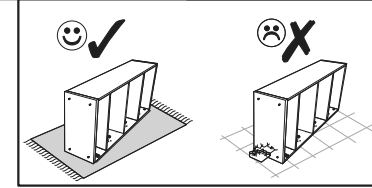

7

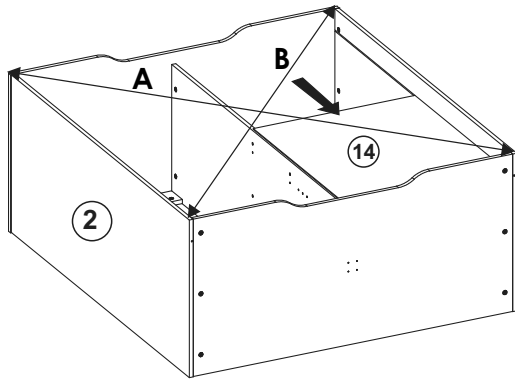
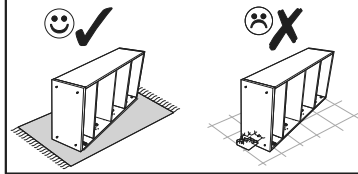
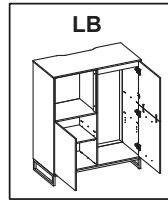
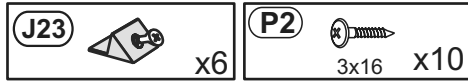

A=B

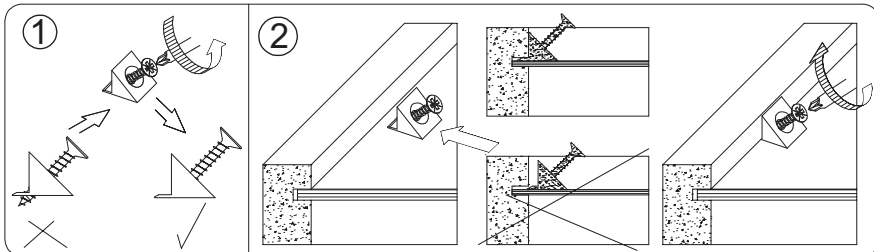
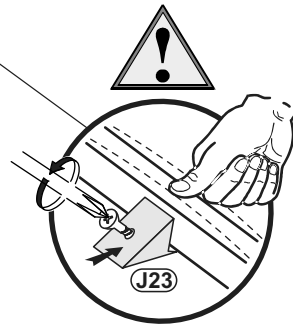
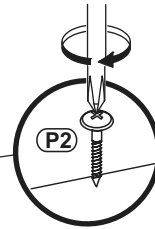
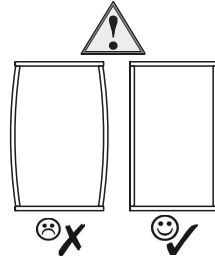

8

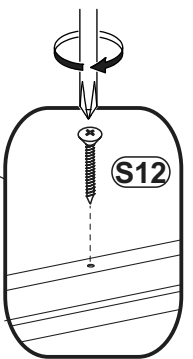
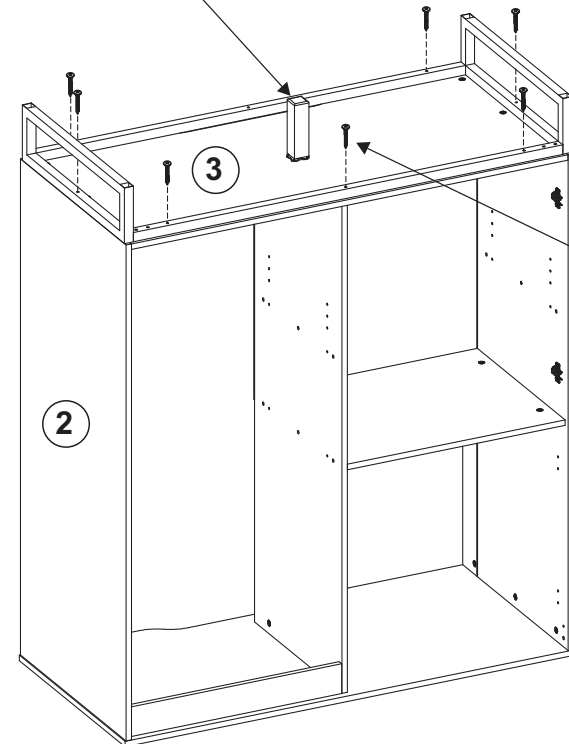
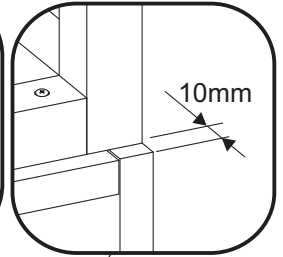
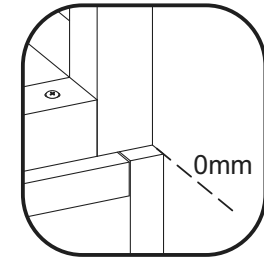
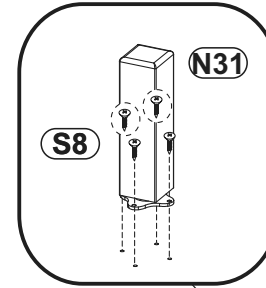
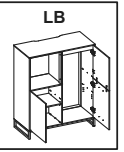
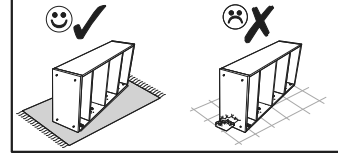
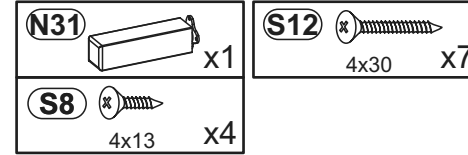

9

- P4** 4x25 x6
- C9** fi 20 x26

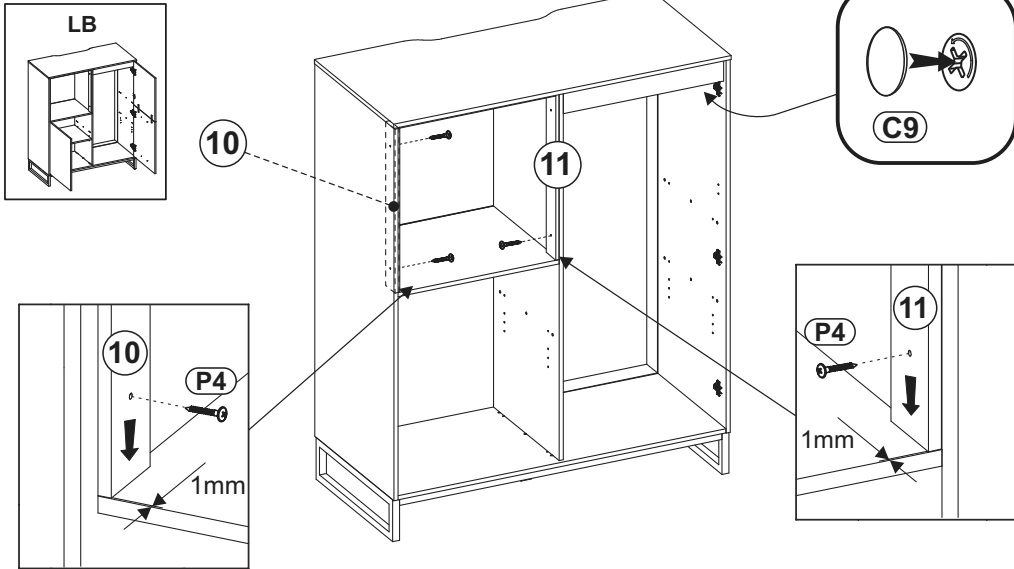

16

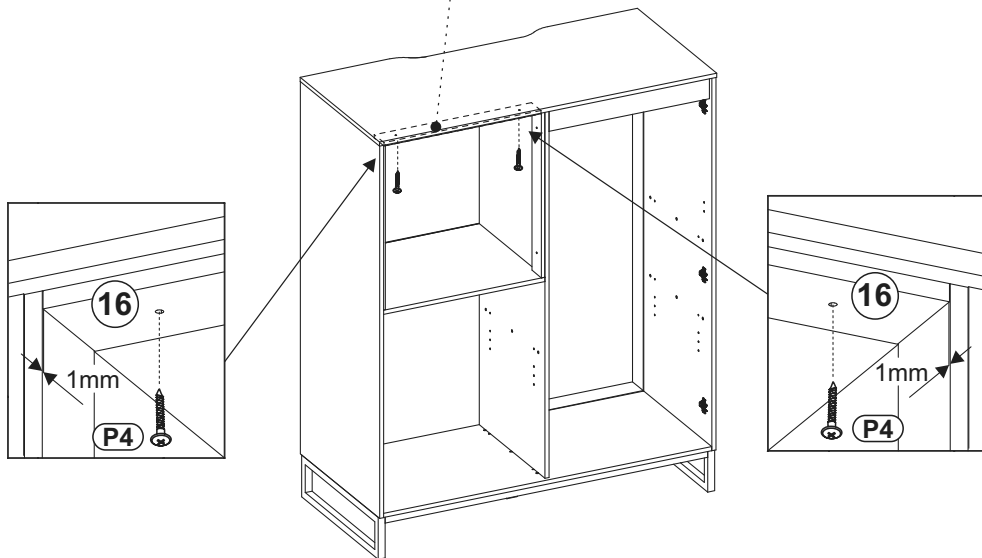

10

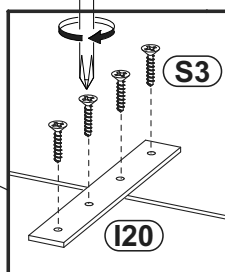
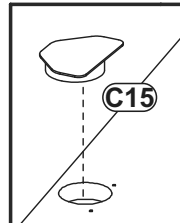
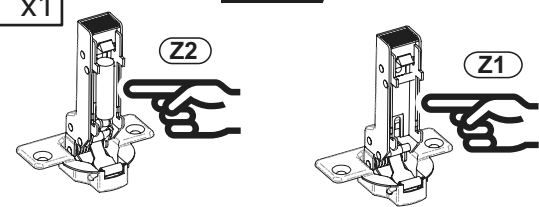
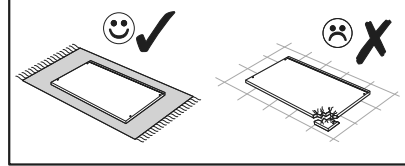
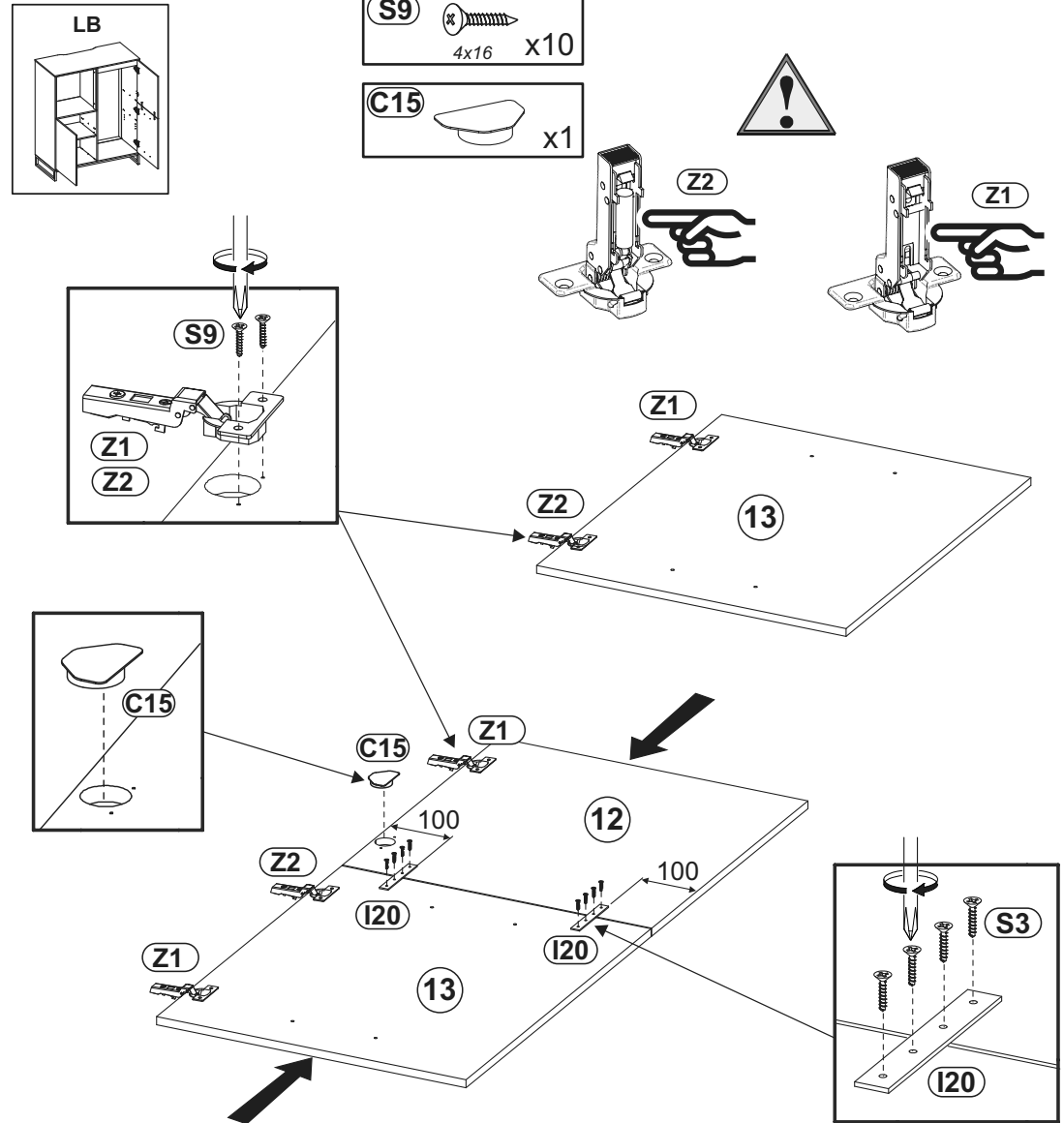

- I20** x2
- S3** 3,5x13 x8
- Z1** x3
- Z2** x2
- S9** 4x16 x10
- C15** x1

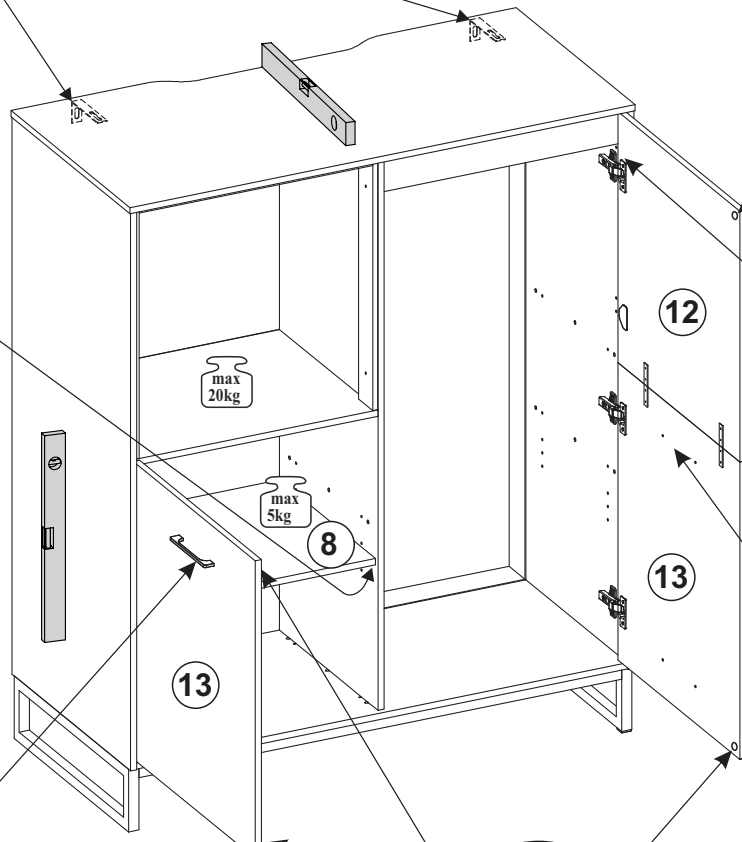
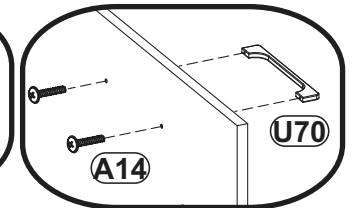
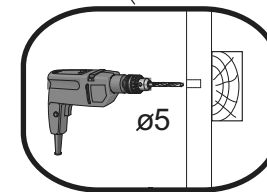
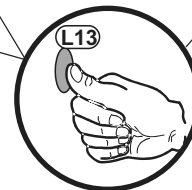
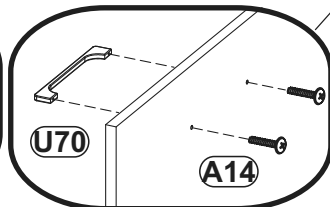
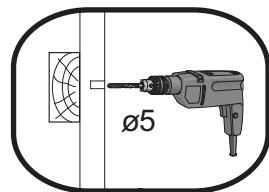
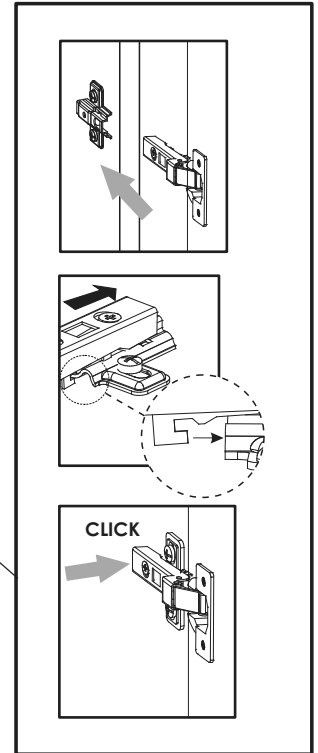
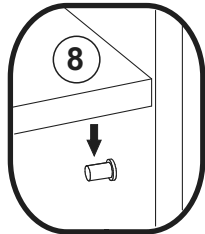
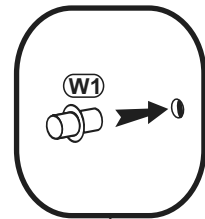
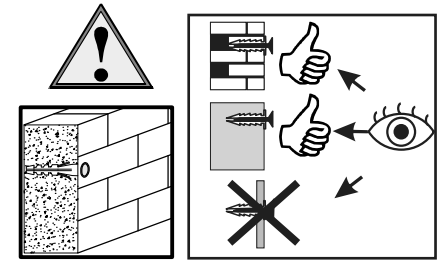
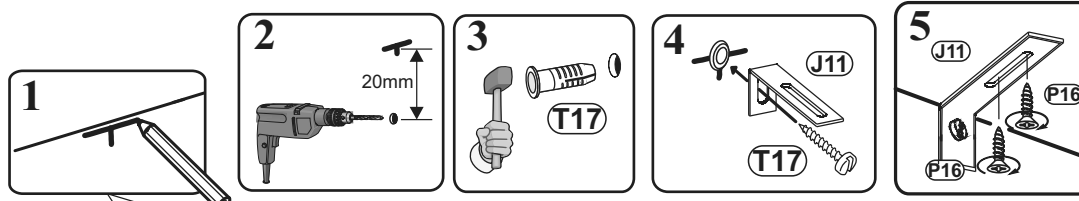
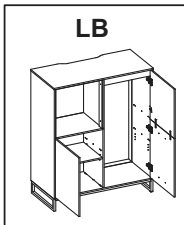
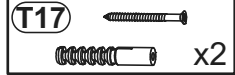
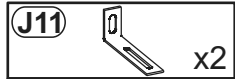
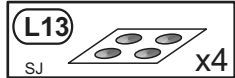
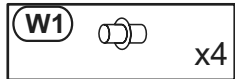
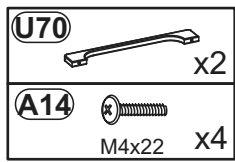

11

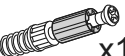

1

- T1**  x12
- B1**  fi 8x28 x12
- D1**  H=2 x5

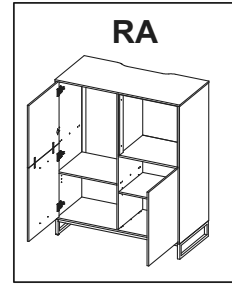

19/68 - 25/68

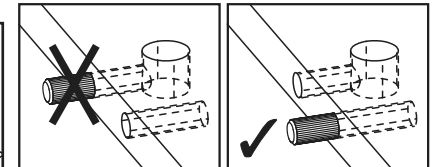
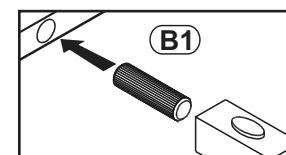
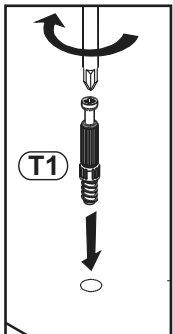
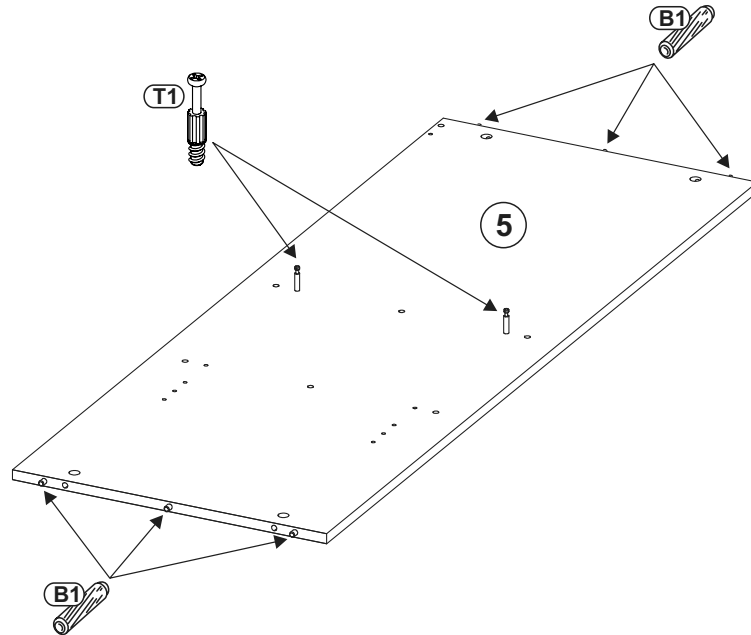
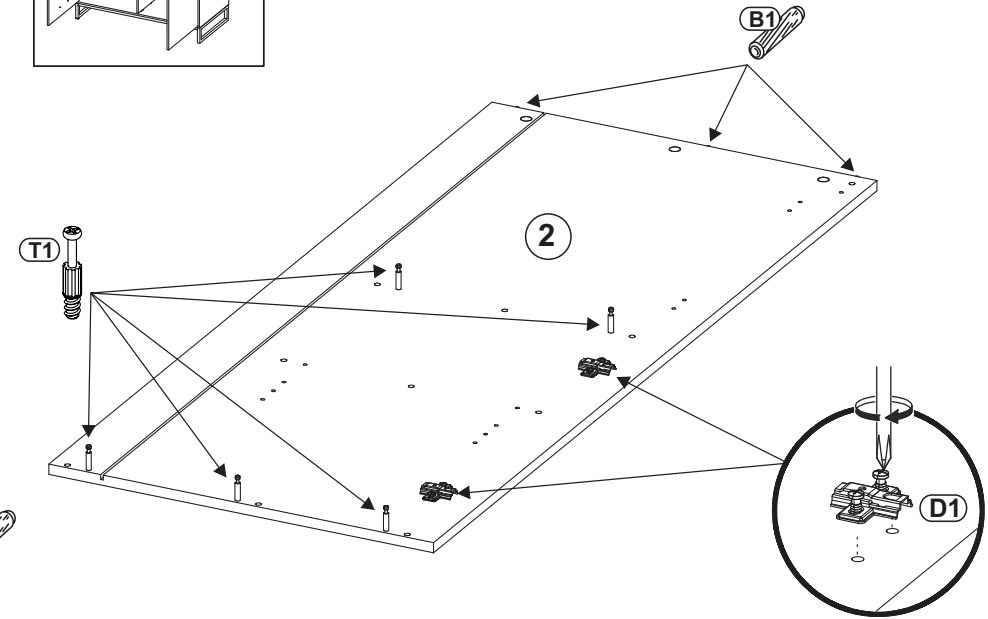
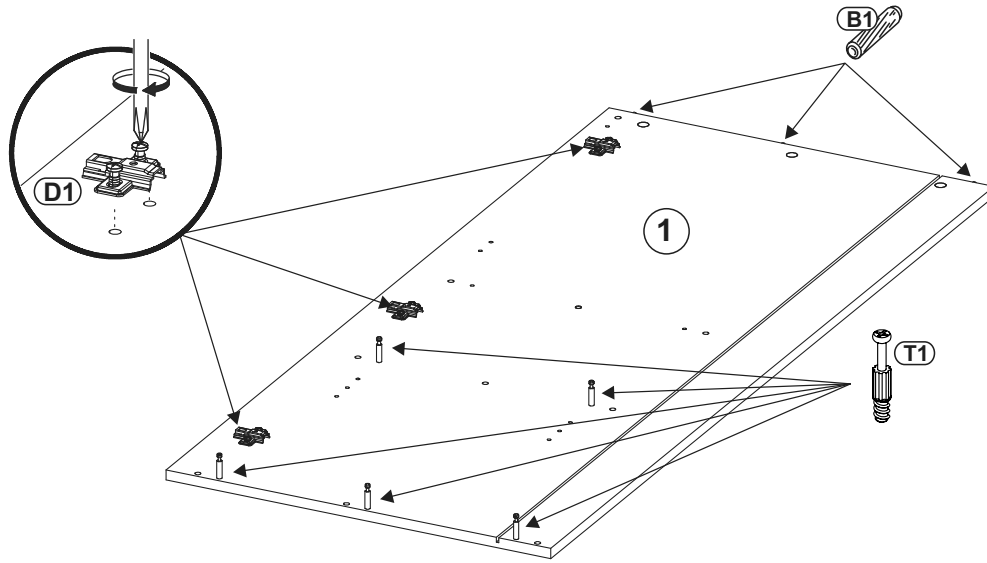
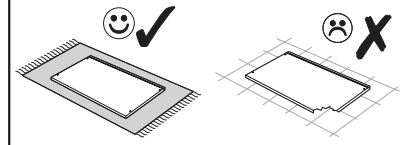

2

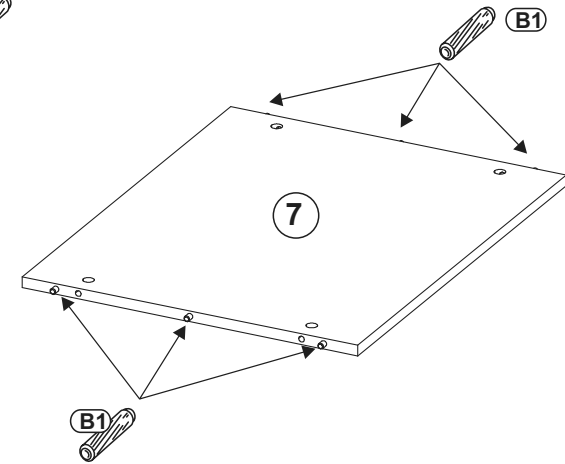
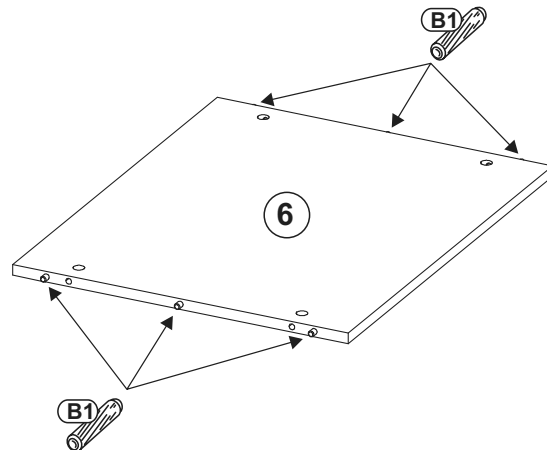
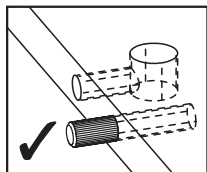
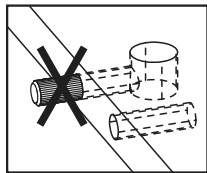
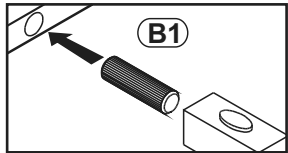
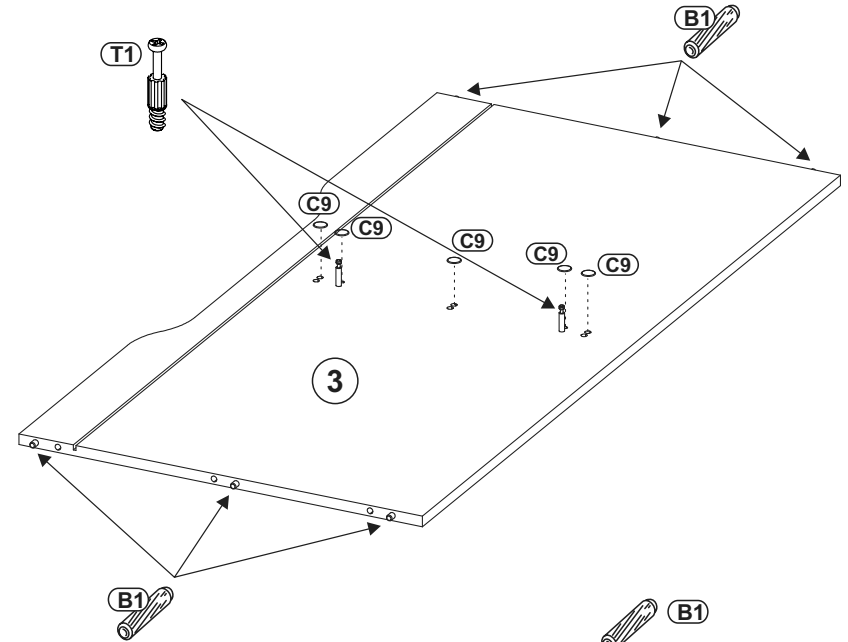
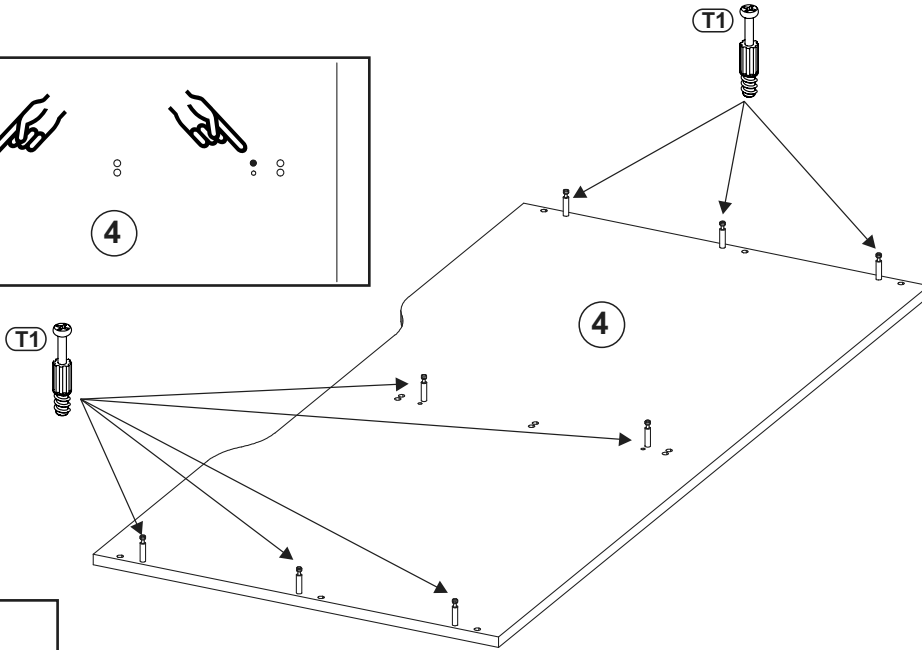
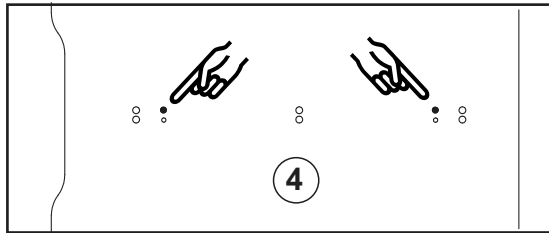
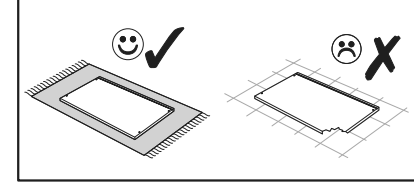
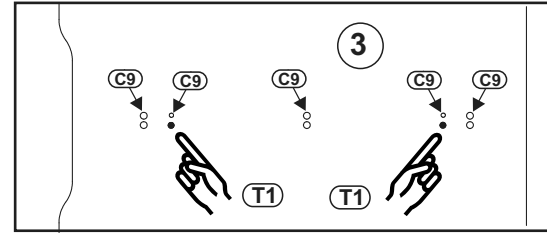
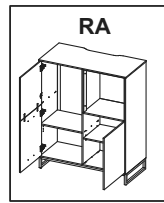
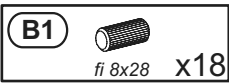
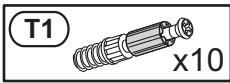

3

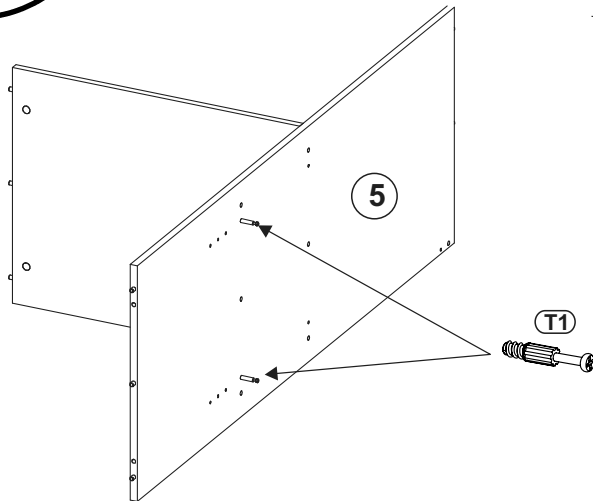
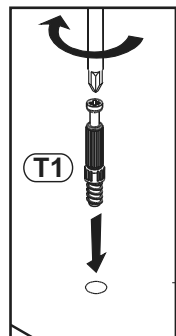
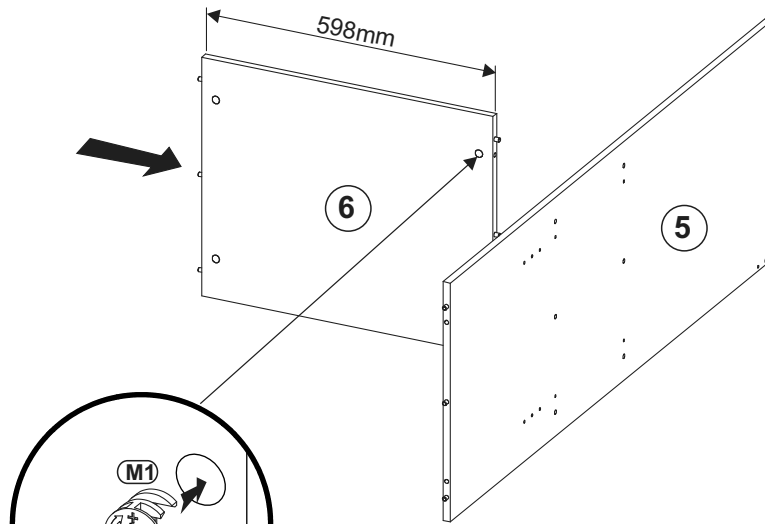
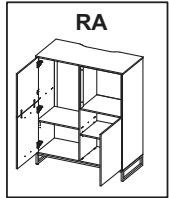
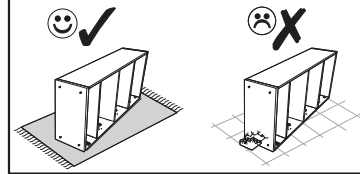
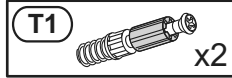

4

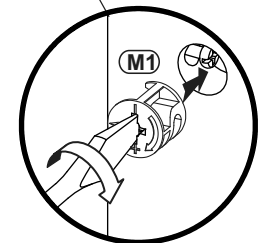
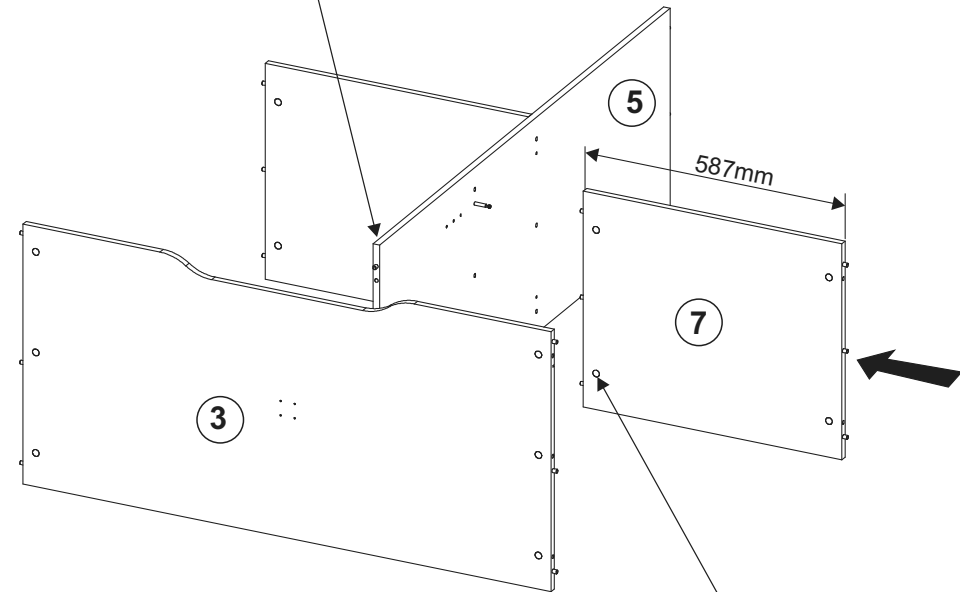
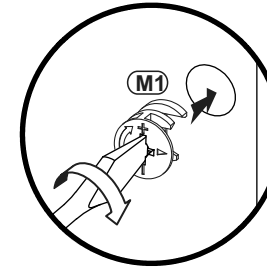
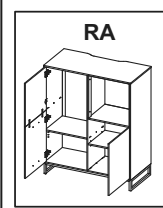
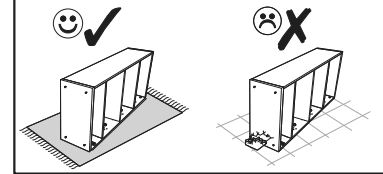

5

M1  x10

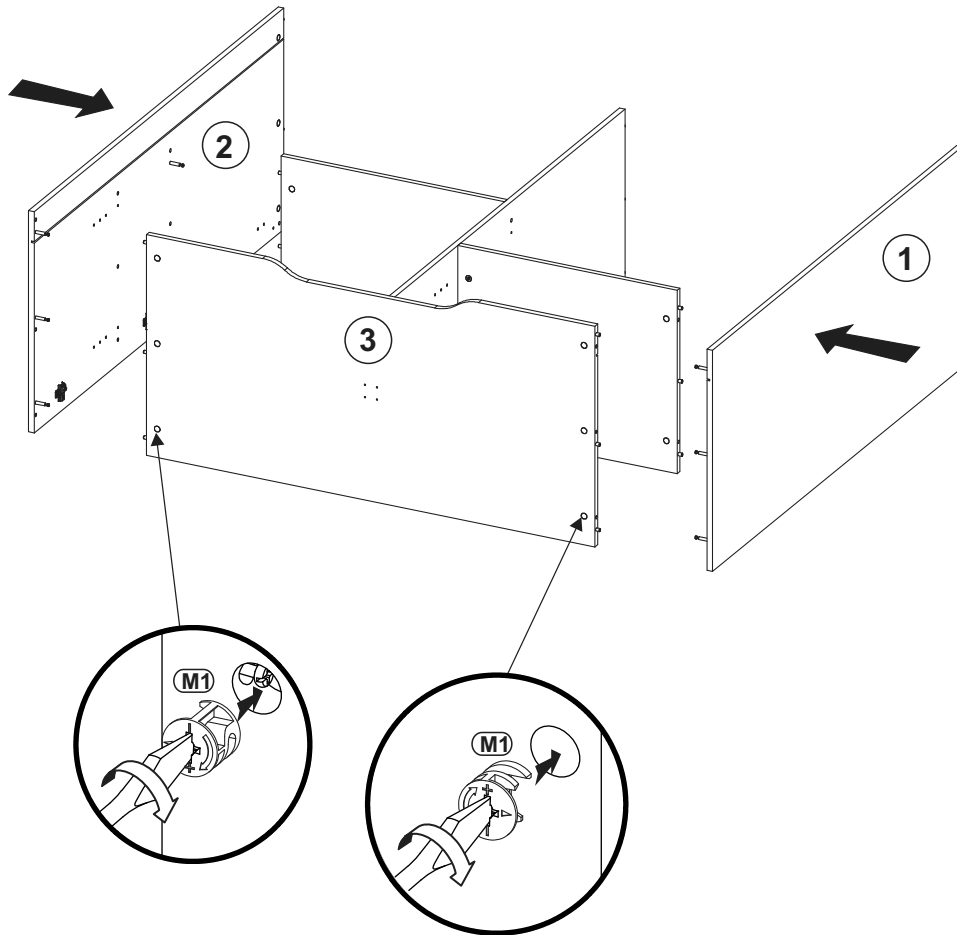
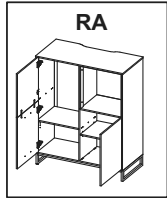
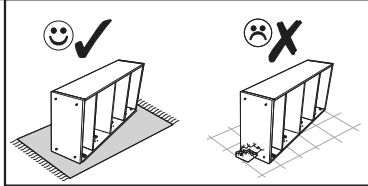

6

M1  x8

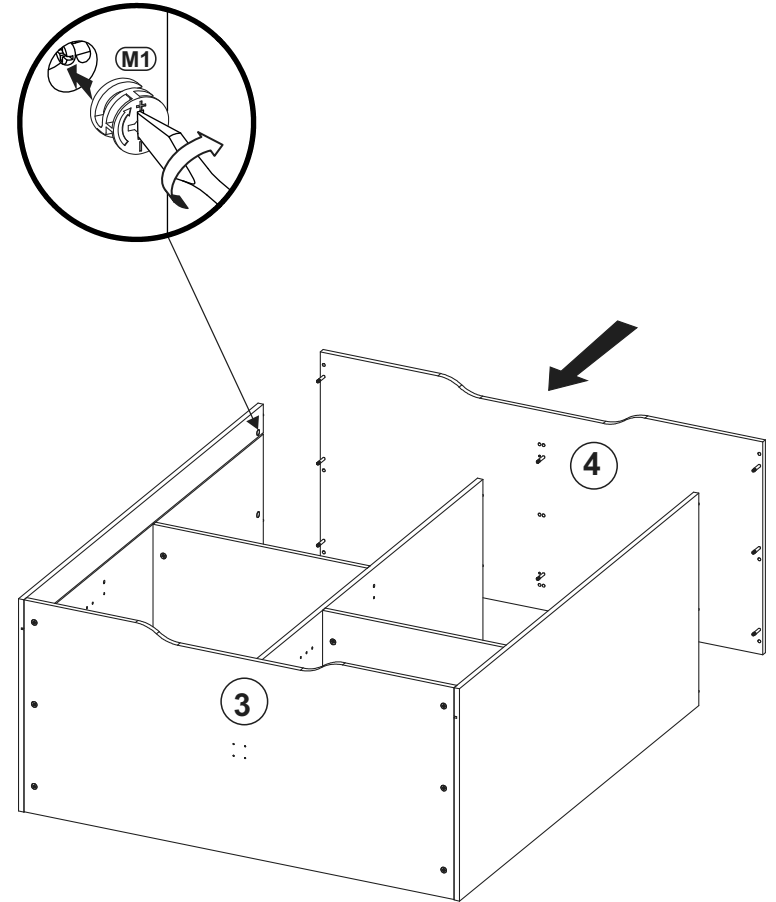
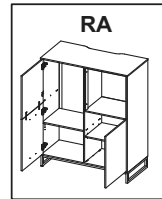
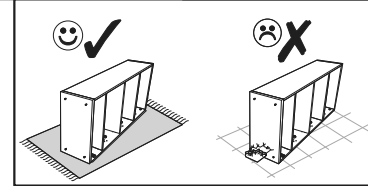

7

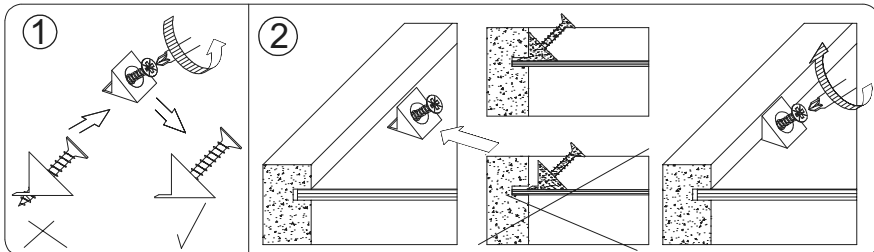
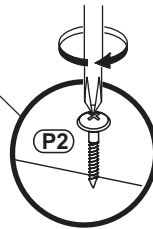
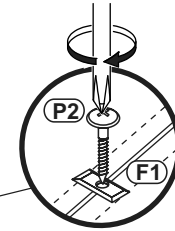
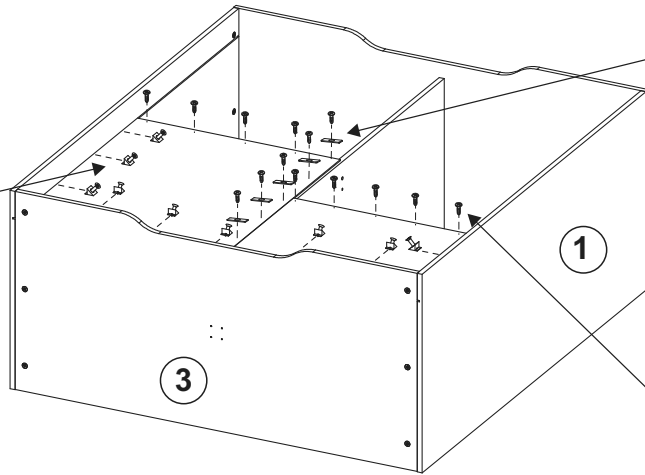
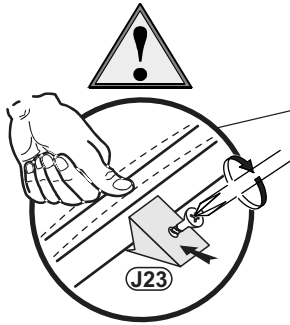
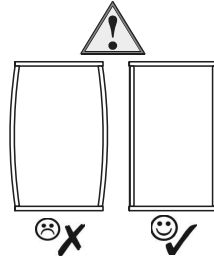
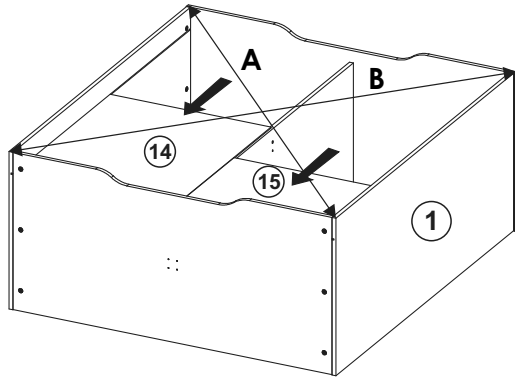
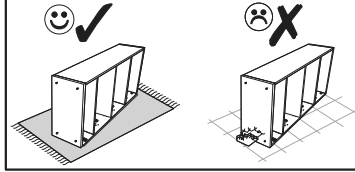
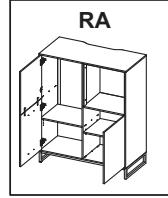
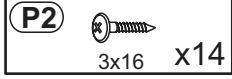
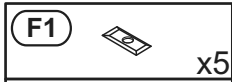

8

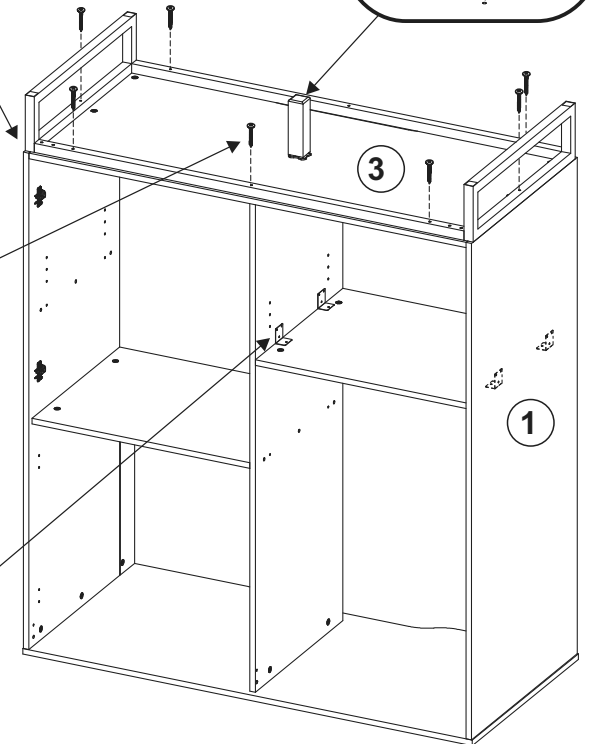
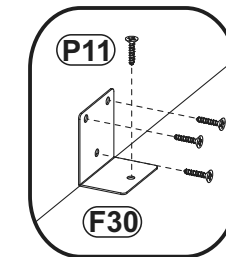
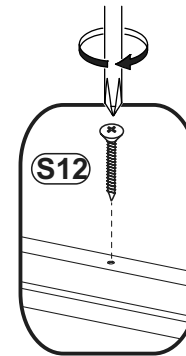
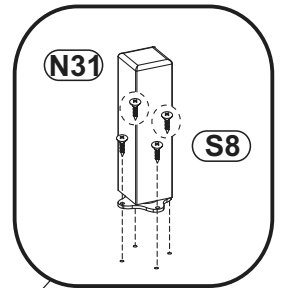
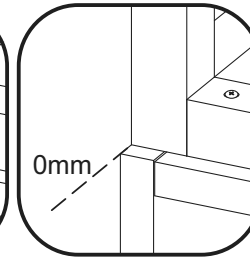
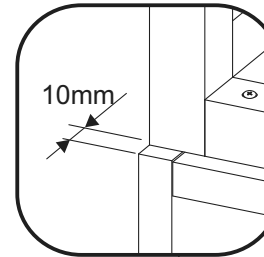
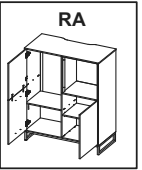
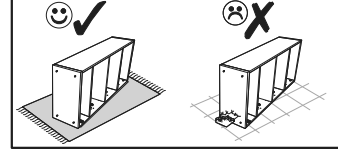
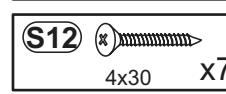
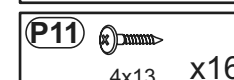
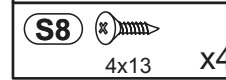
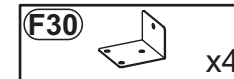
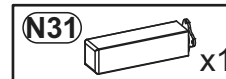

9

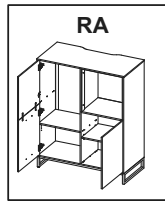
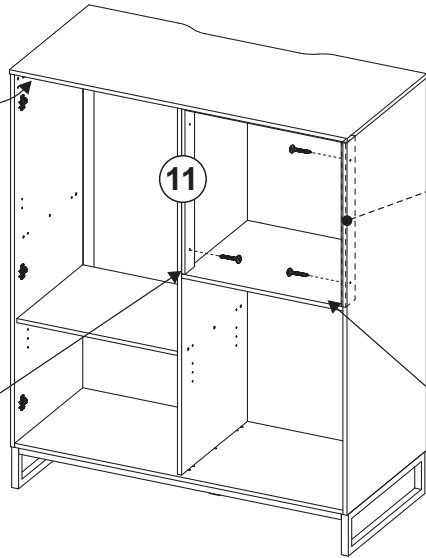
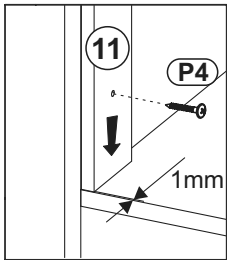
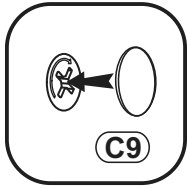
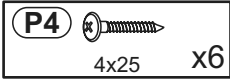

10

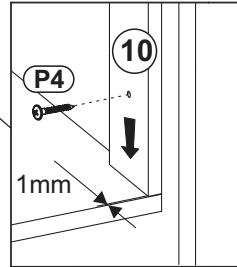

16

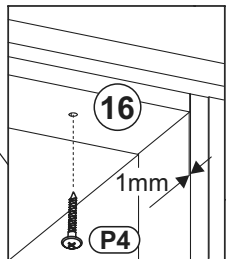
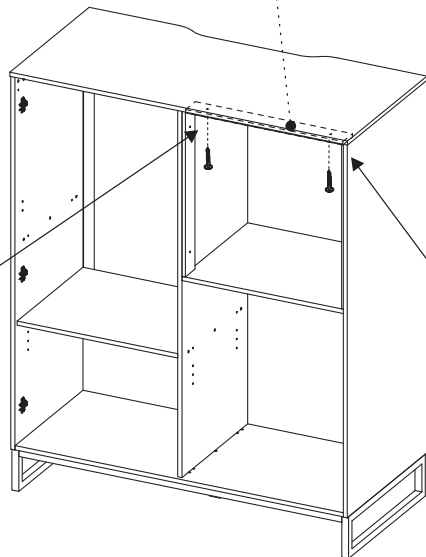
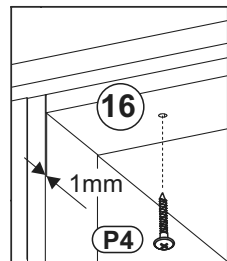

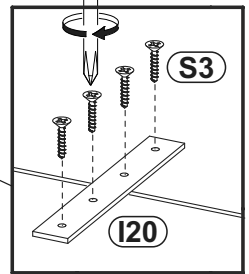
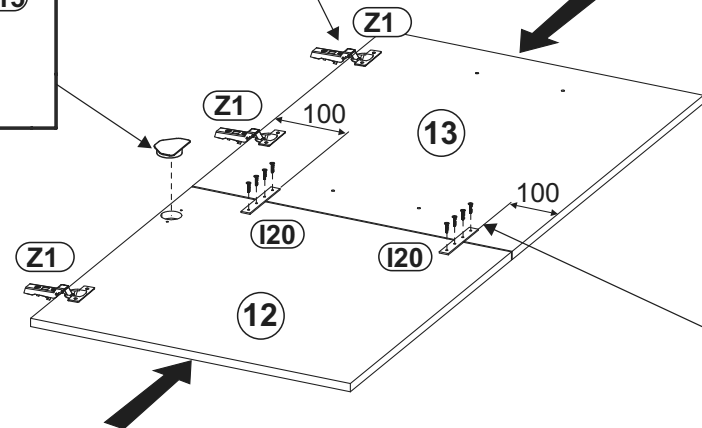
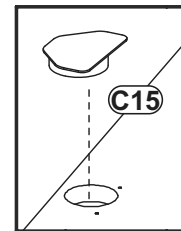
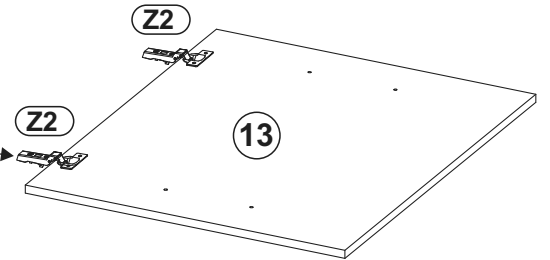
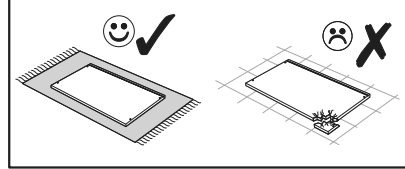
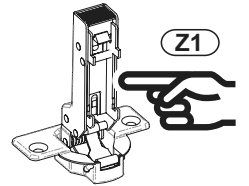
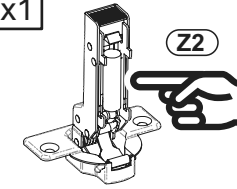
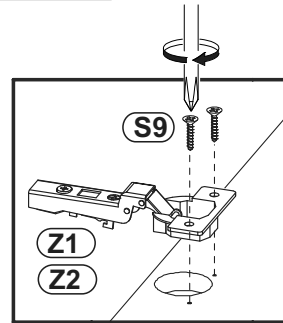
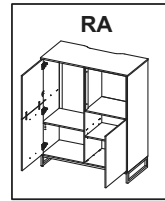
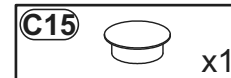
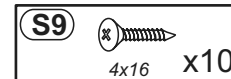
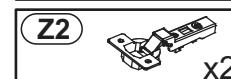
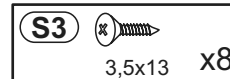
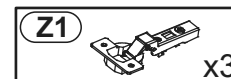
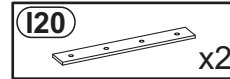

10

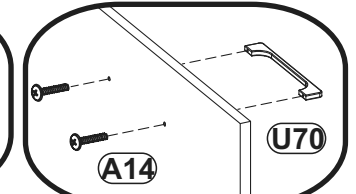
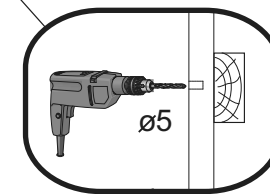
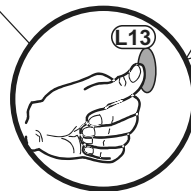
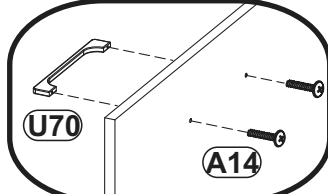
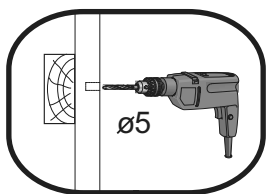
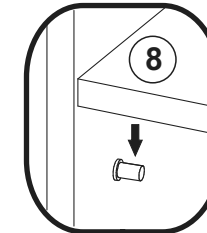
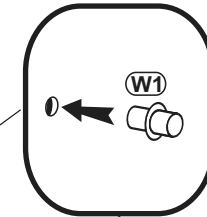
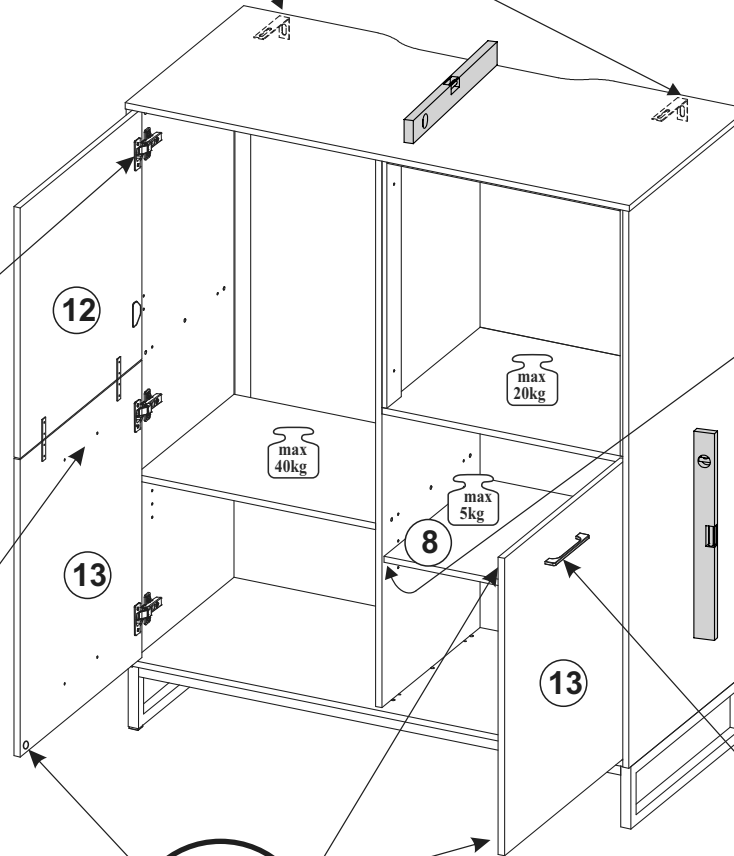
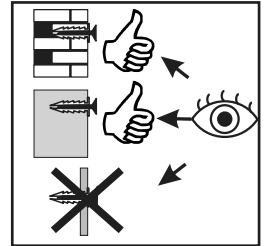
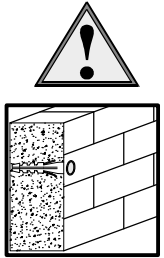
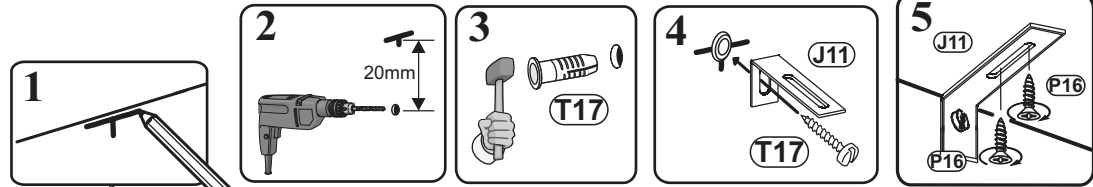
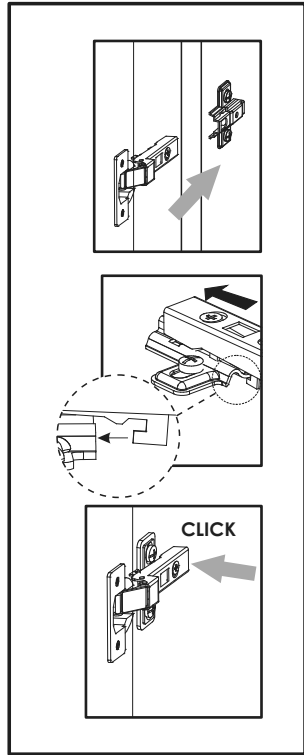
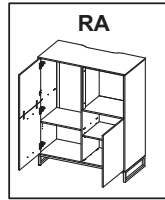
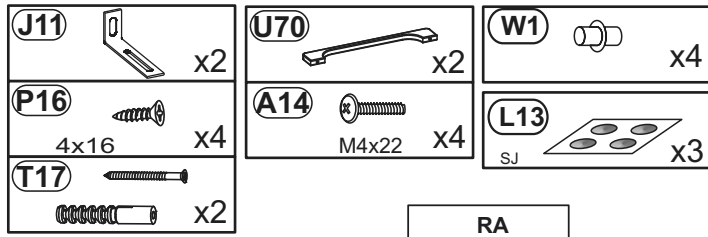

11

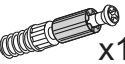

1

- T1**  x12
- B1**  fi 8x28 x12
- D1**  H=2 x5

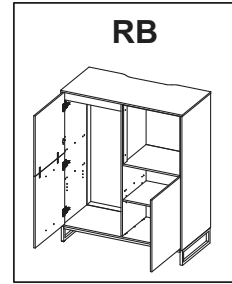

26/68 - 32/68

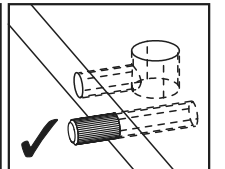
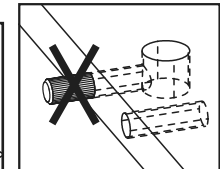
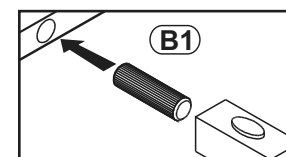
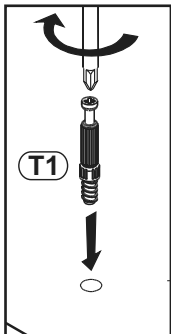
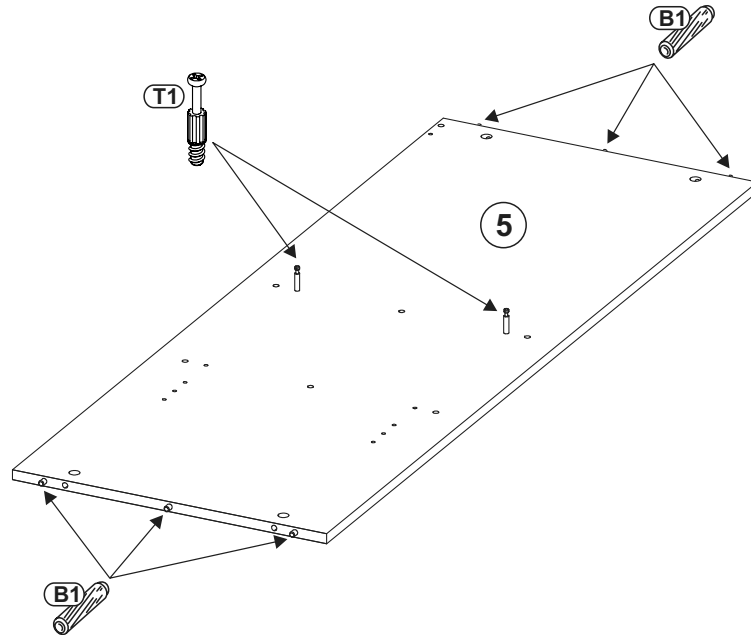
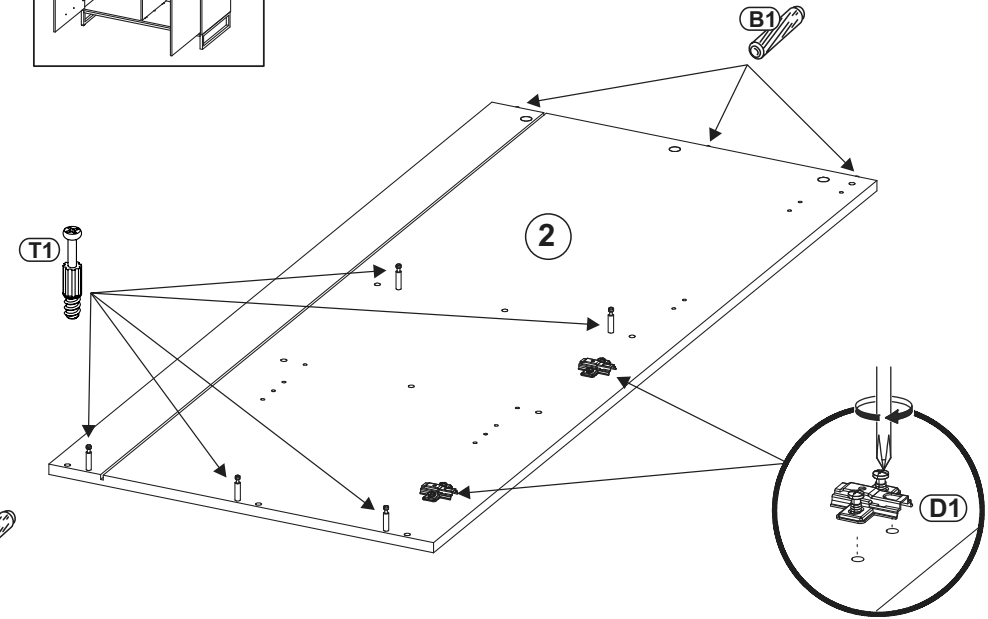
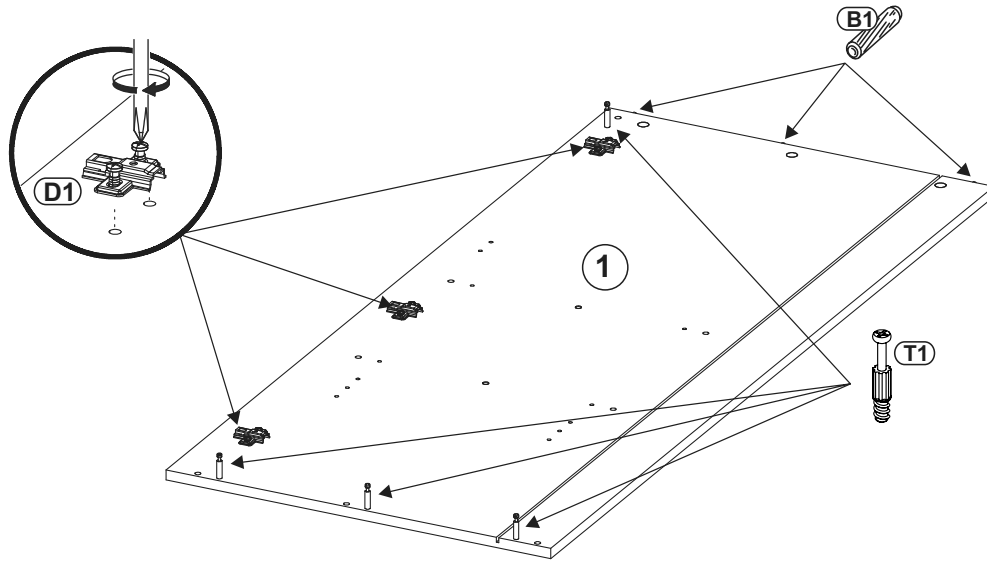
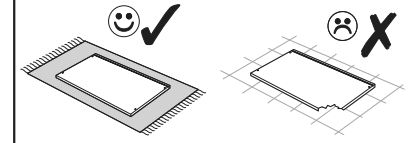

2

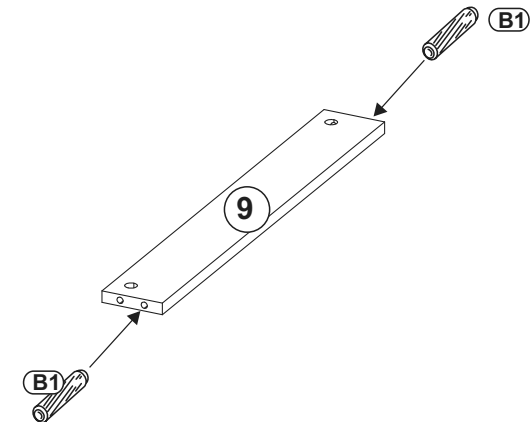
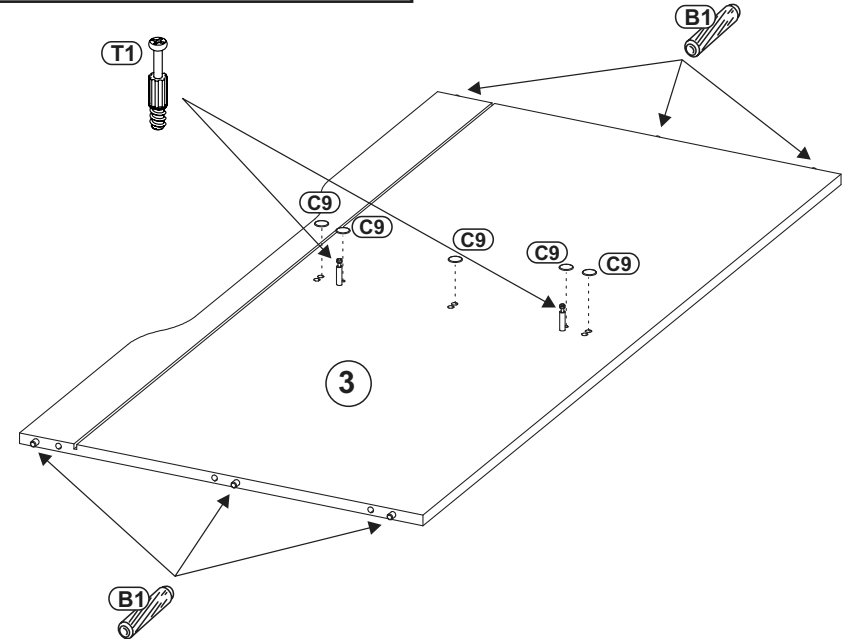
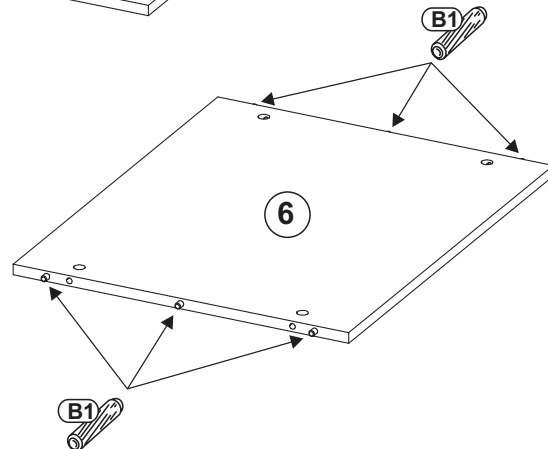
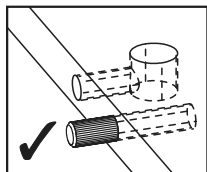
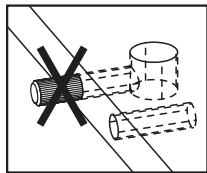
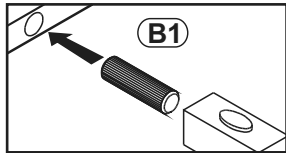
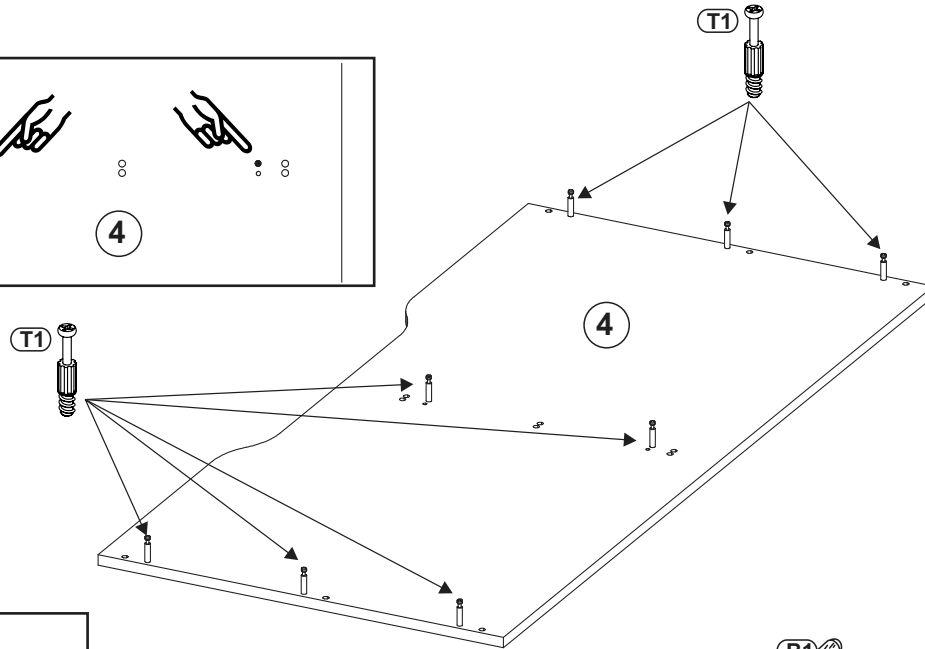
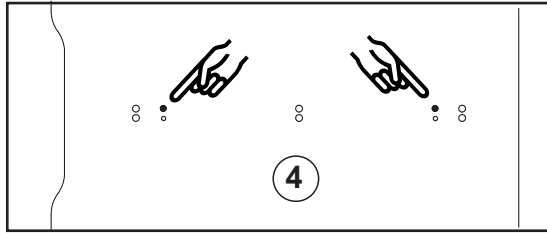
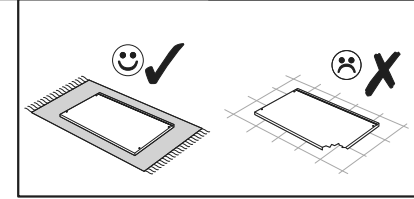
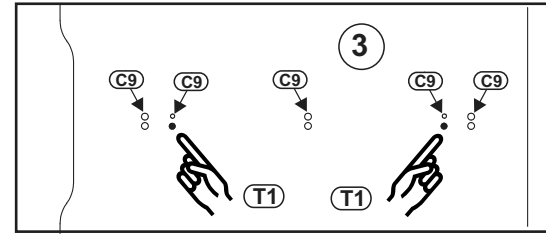
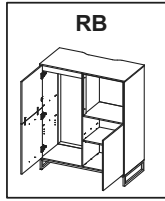
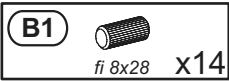
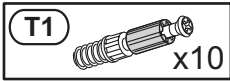

3

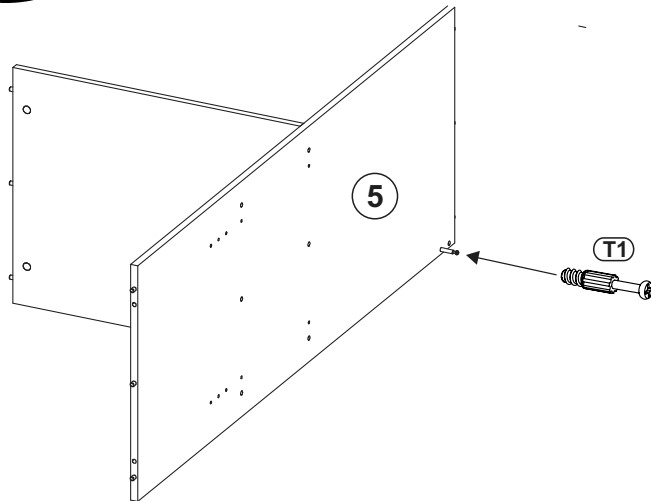
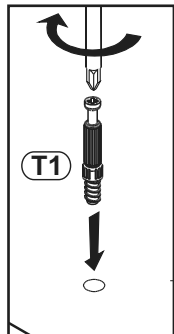
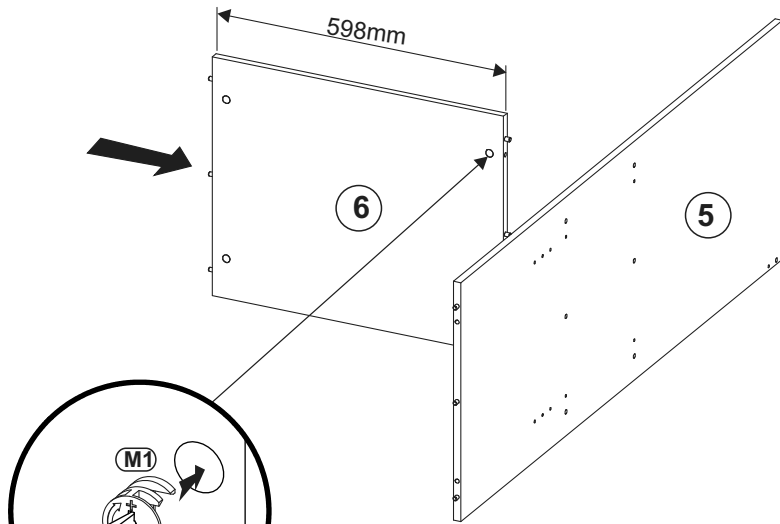
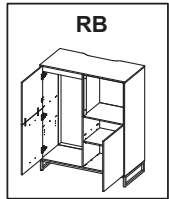
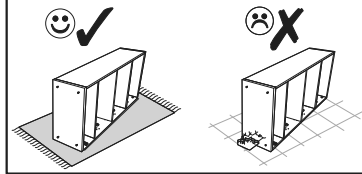
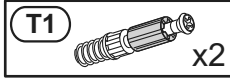

4

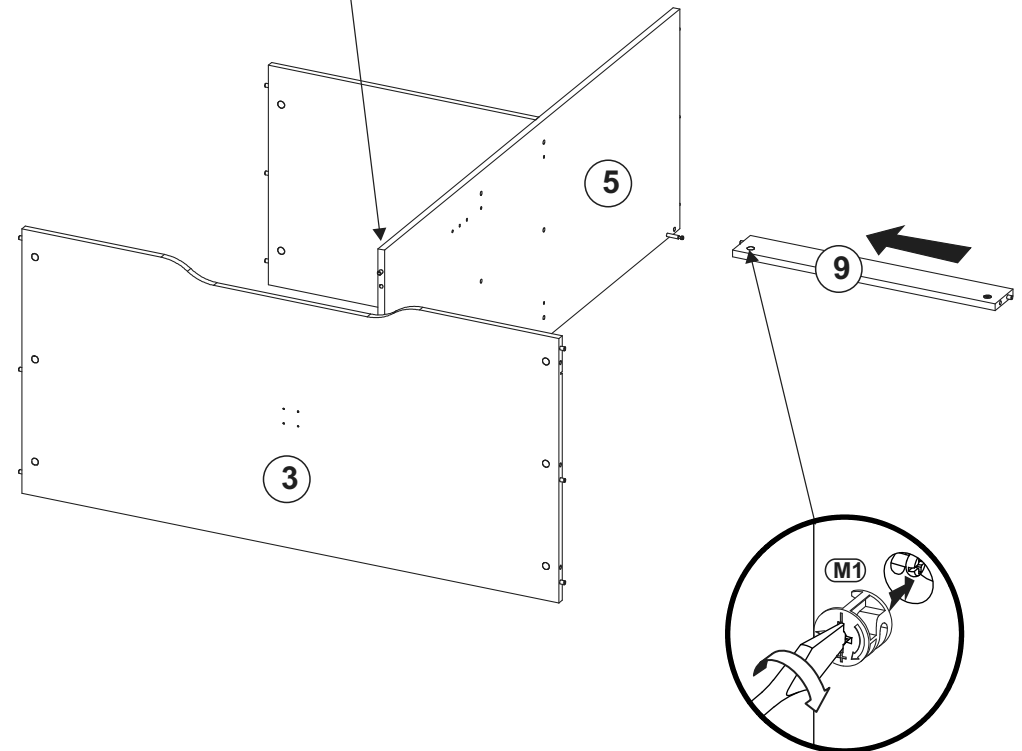
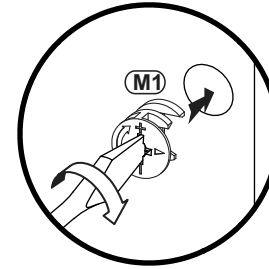
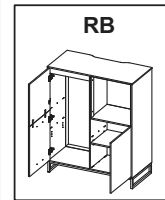
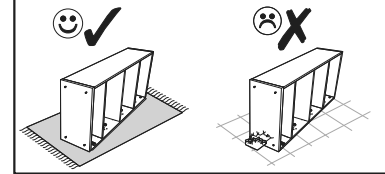

5

M1  x9

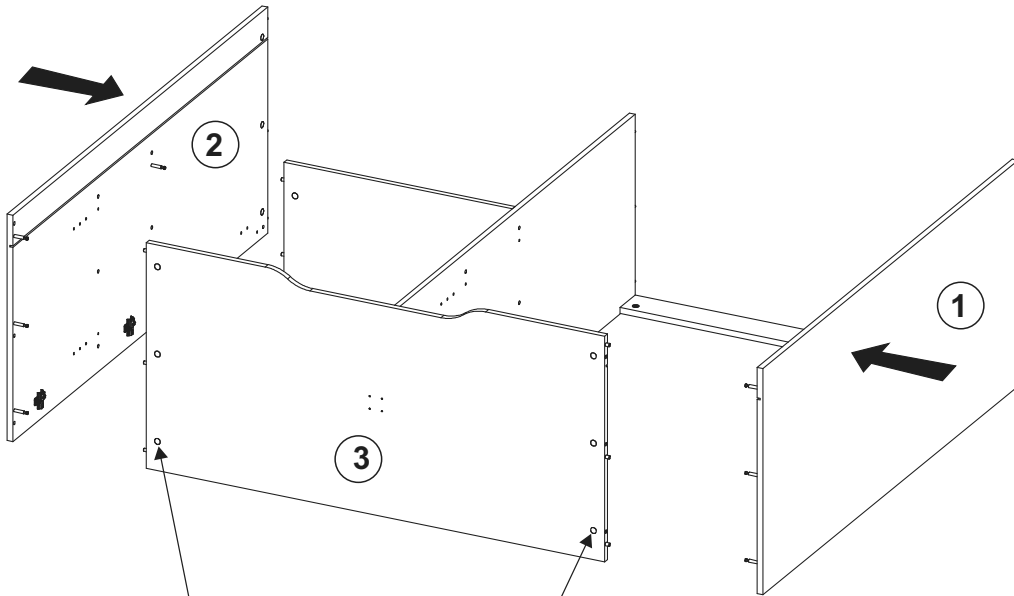
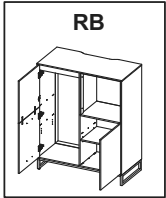
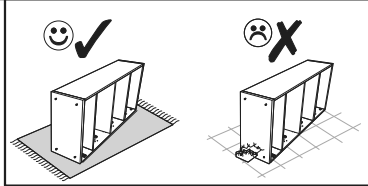

6

M1  x8

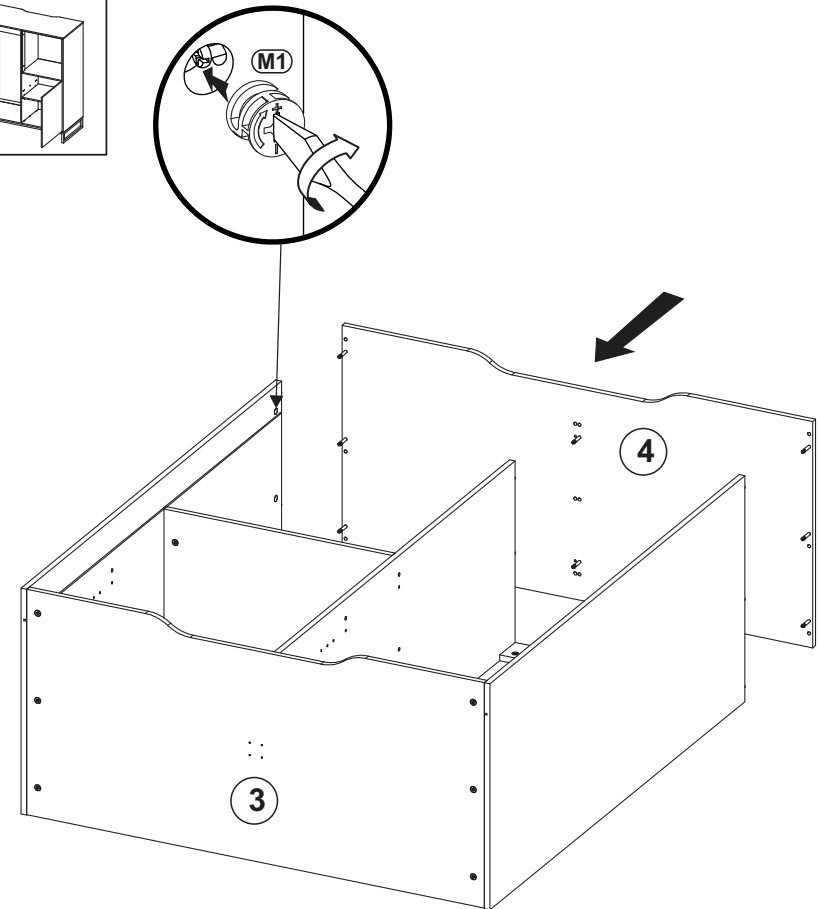
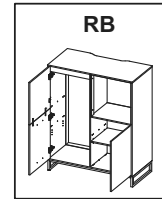
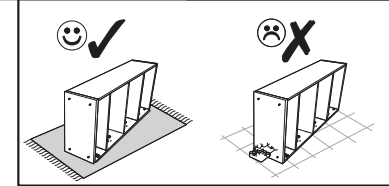

7

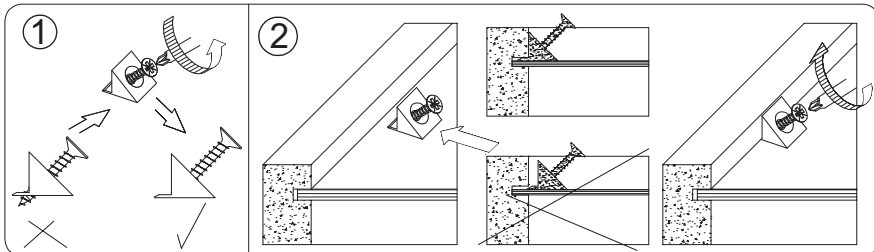
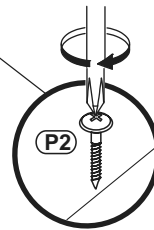
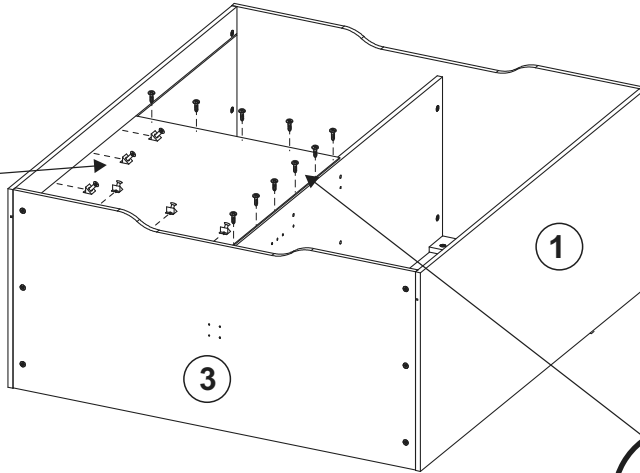
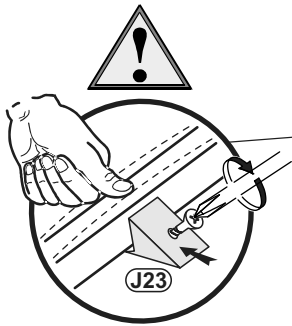
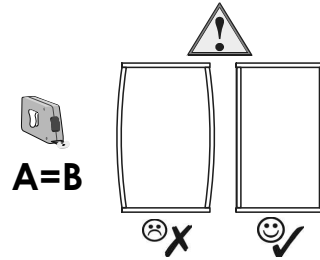
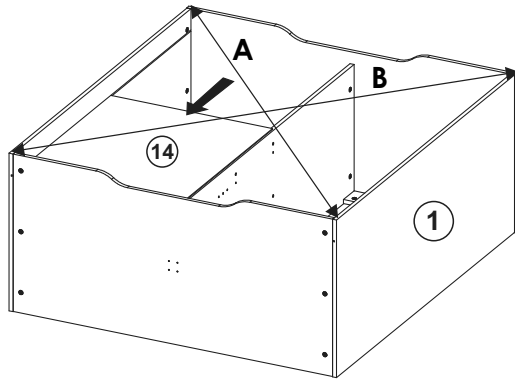
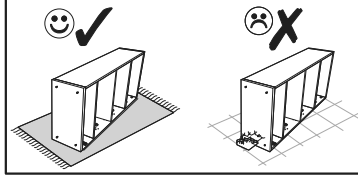
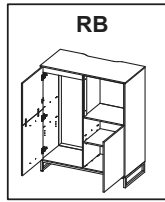
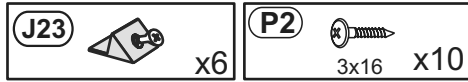

8

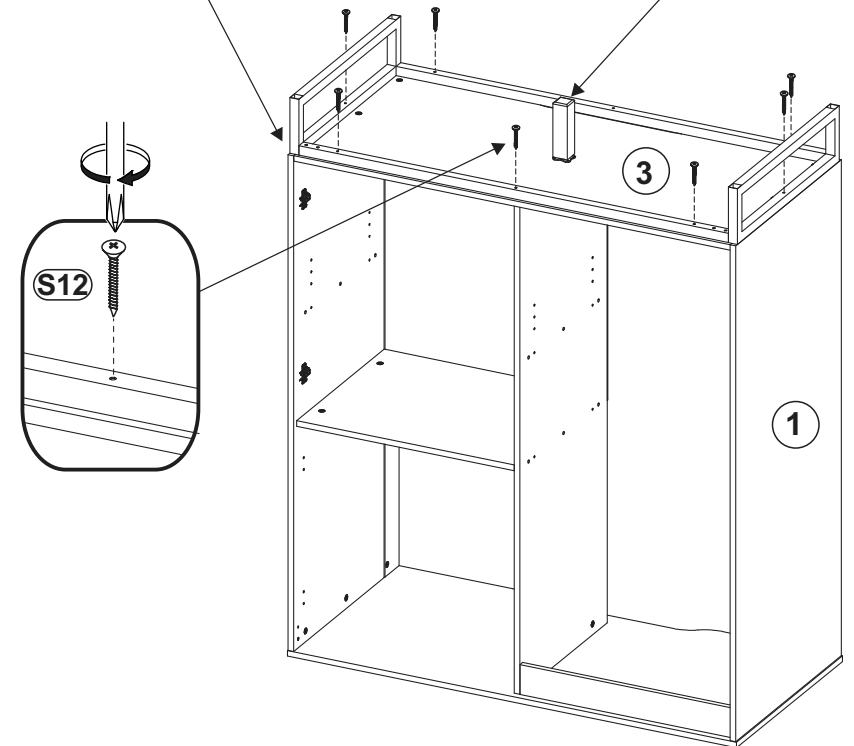
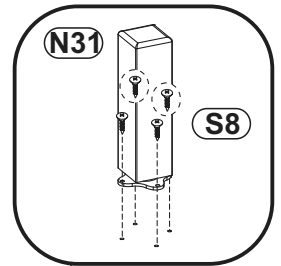
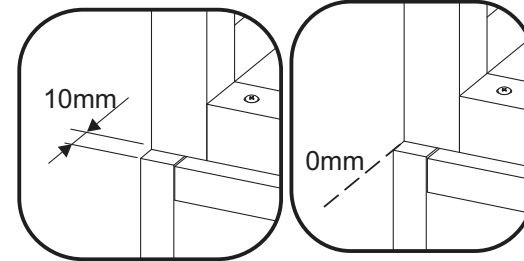
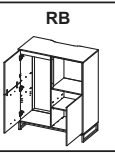
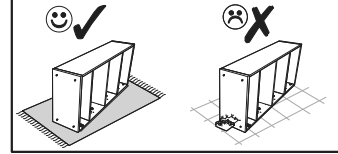
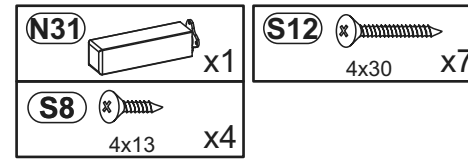

9

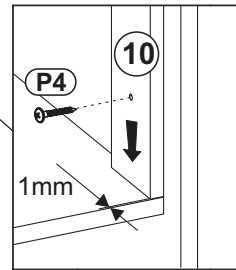
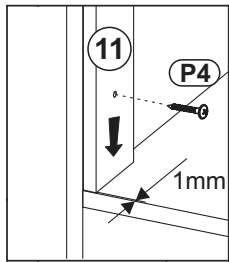
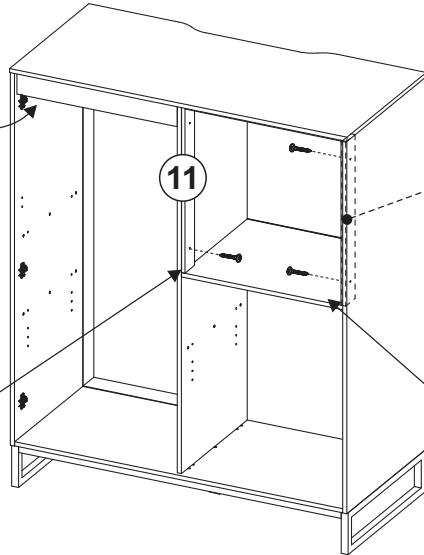
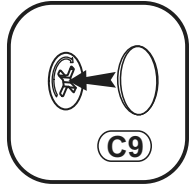
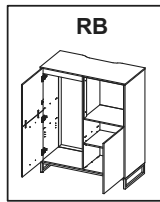
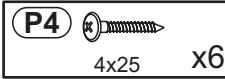

16

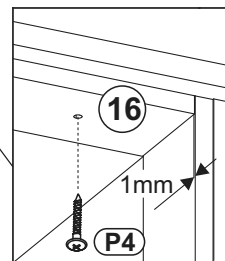
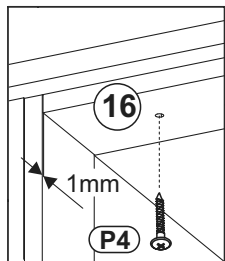
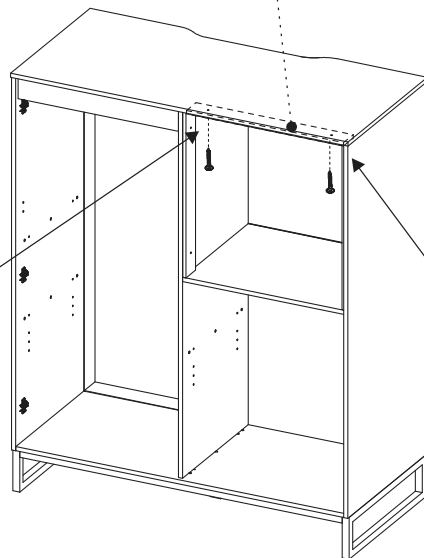

10

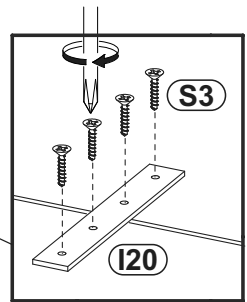
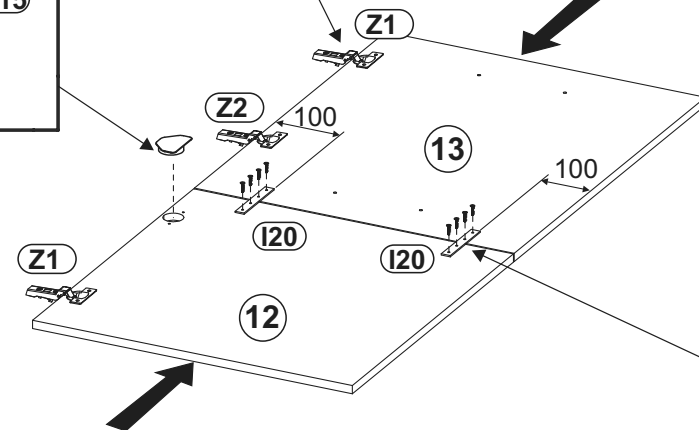
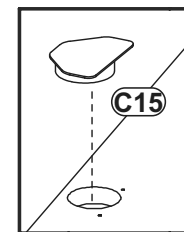
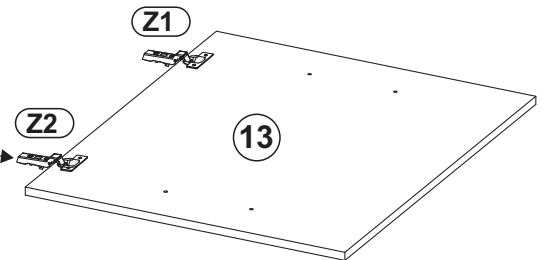
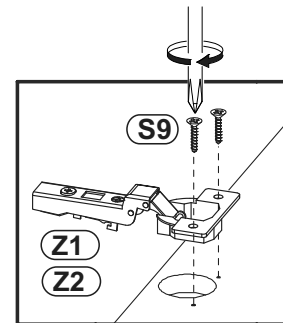
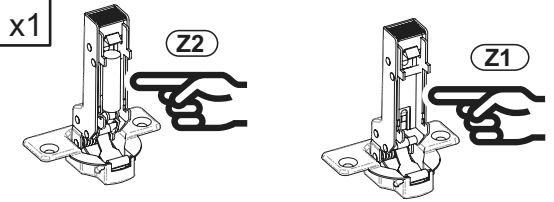
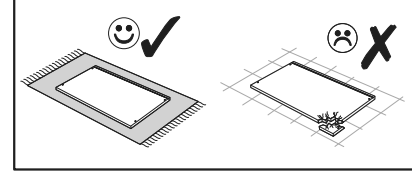
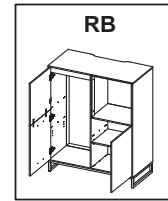
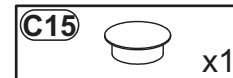
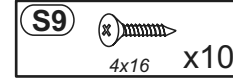
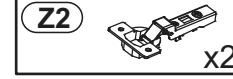
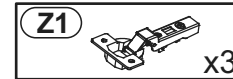
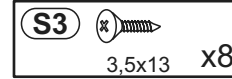
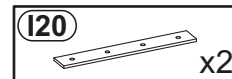

11

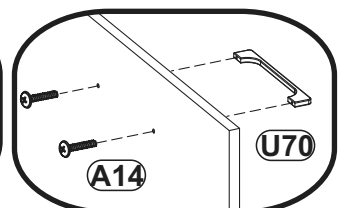
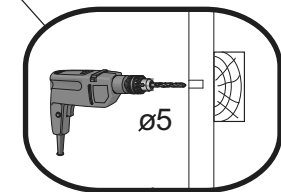
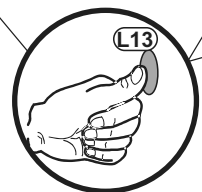
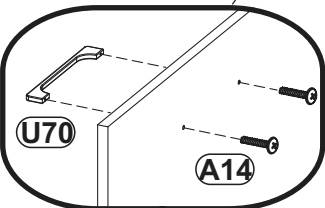
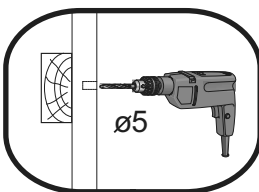
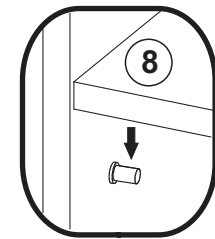
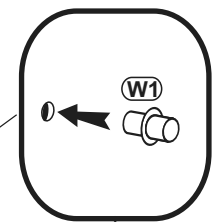
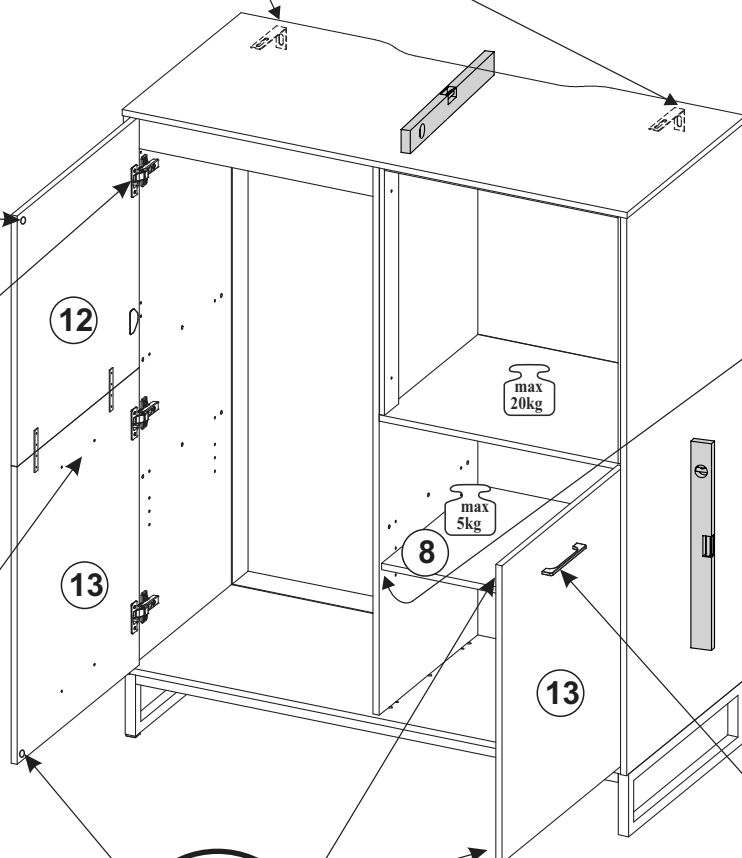
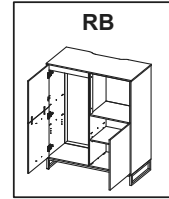
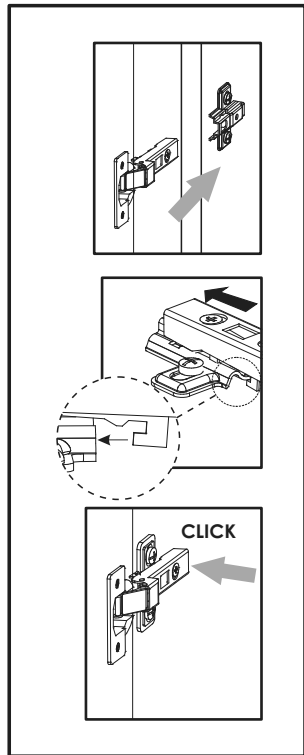
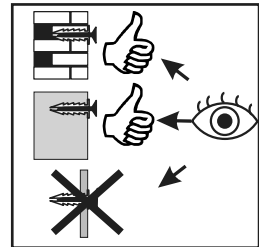
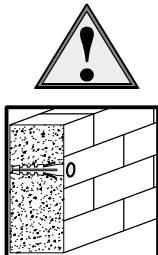
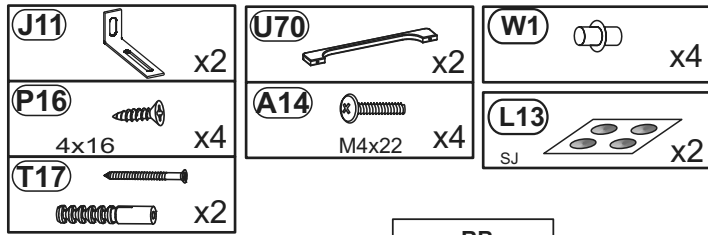

Service • Assistenza • Dienstverlening • Serwis Servis • Szerviz • Servizio • Usluga •

Name • Nom • Nome • Naam • Nazwa Jméno • Názov • Név • Denumire Nombre • Ime • Isim	MONTREAL
Nr. • No. • N° • říeříd • Ć • Sz • Ne	
Typ • Type • Tip • Típus • Tipo	2D3S

shop • geschäft • boutique • sklep • winkel •
negozio • bolt • tienda • obchod • dučan • mađaza • magazin

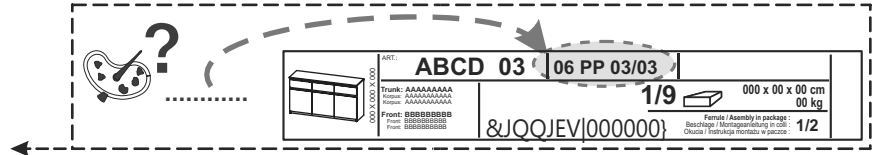
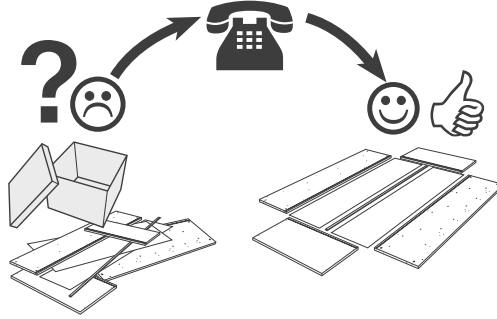

Col. nr 1/9-4/9

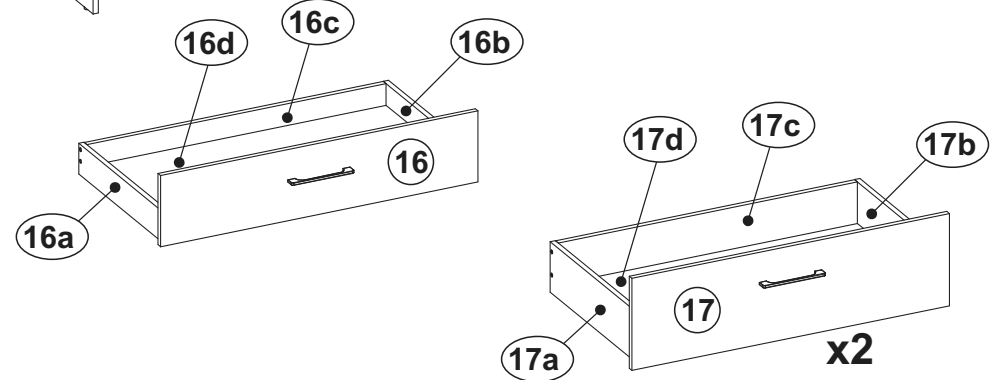
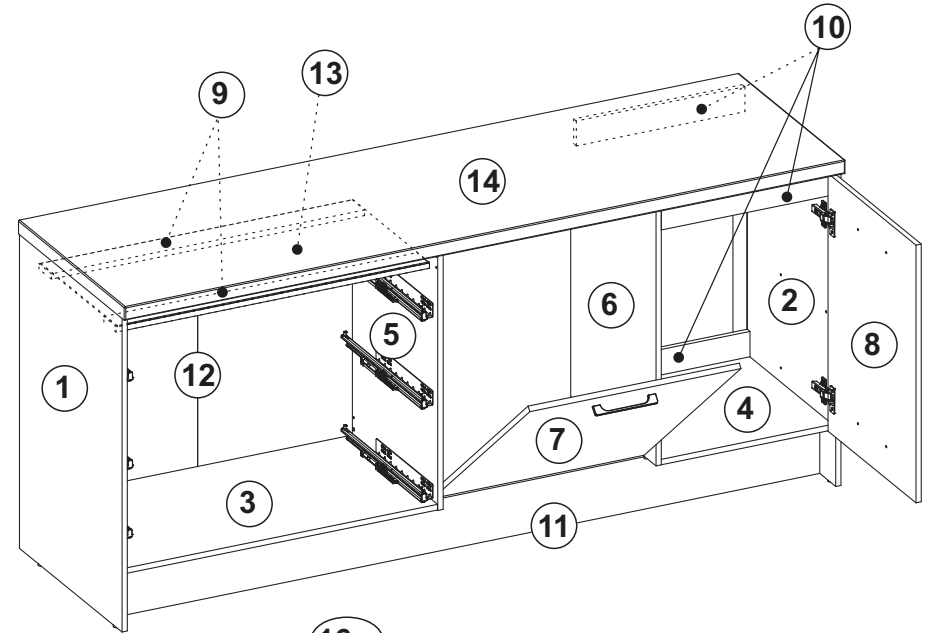

M1 15x12,5 x53	J23 x2	E1 6,3x13 x12	S3 3,5x13 x8
T1 x53	P2 3x16 x17	S14 4x40 x6	R44 L-450 x3
C9 fi 20 x32	J11 x2	P1 3x13 x6	P17 4x20 x6
L13 SJ x2	P16 4x16 x4	F30 x14	L14 SJ x8
B1 fi 8x28 x46	T17 x2	P11 4x13 x56	Col. nr 1/9
Z1 x1	U70 x5	N30 x8	
Z2 x1	A14 M4x22 x10	N31 x4	
S9 4x16 x4	N32 x8	N31 x4	
D1 H=2 x2	K1 7x50 x12	S9 4x16 x32	

0 10 20 30 40 50 60 70 80 90 100 110 120 130 140 150 160 170 180 190 200



L



35/68 - 46/68

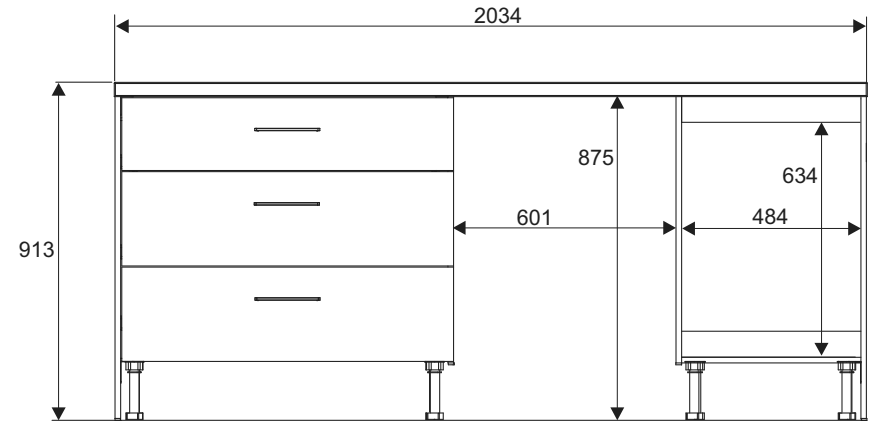
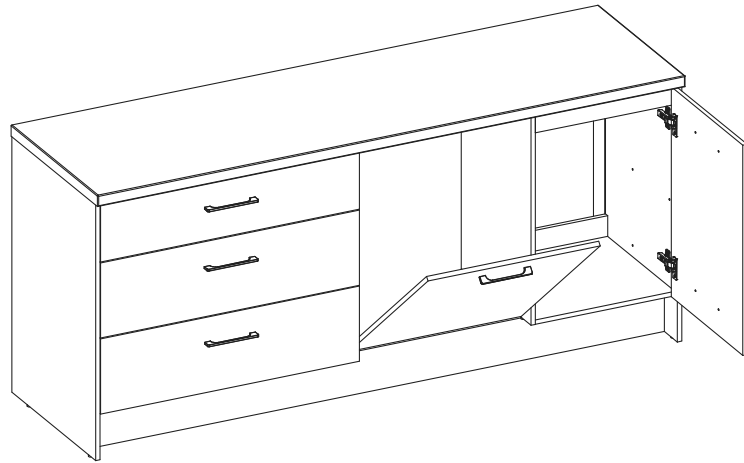

R



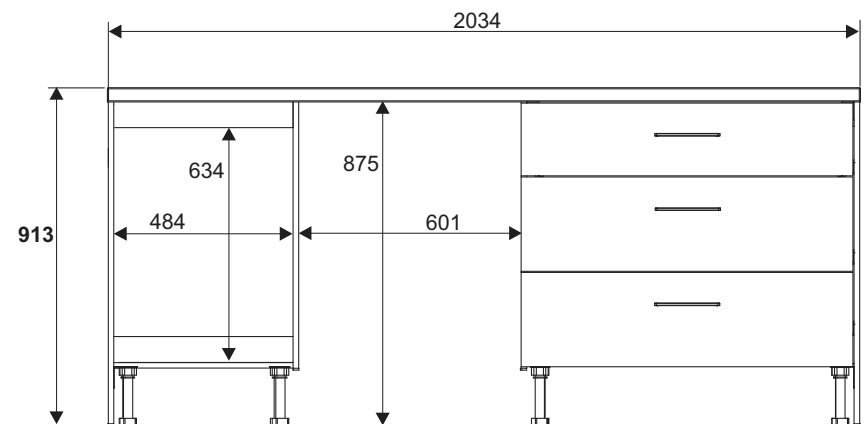
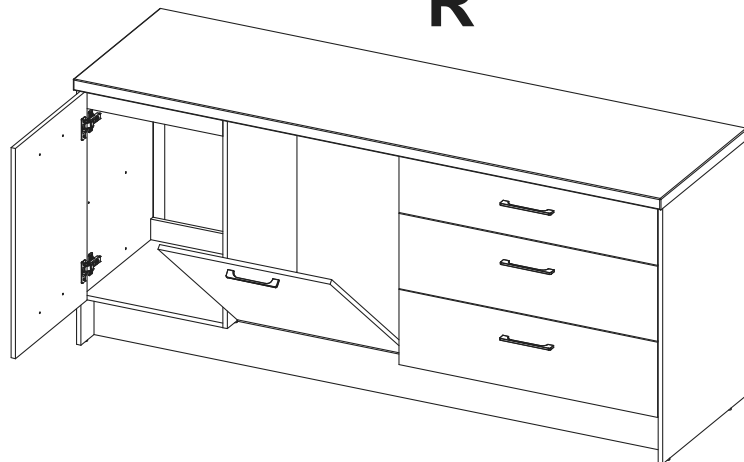

47/66 - 58/66

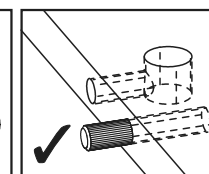
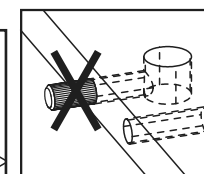
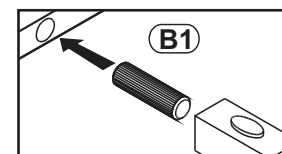
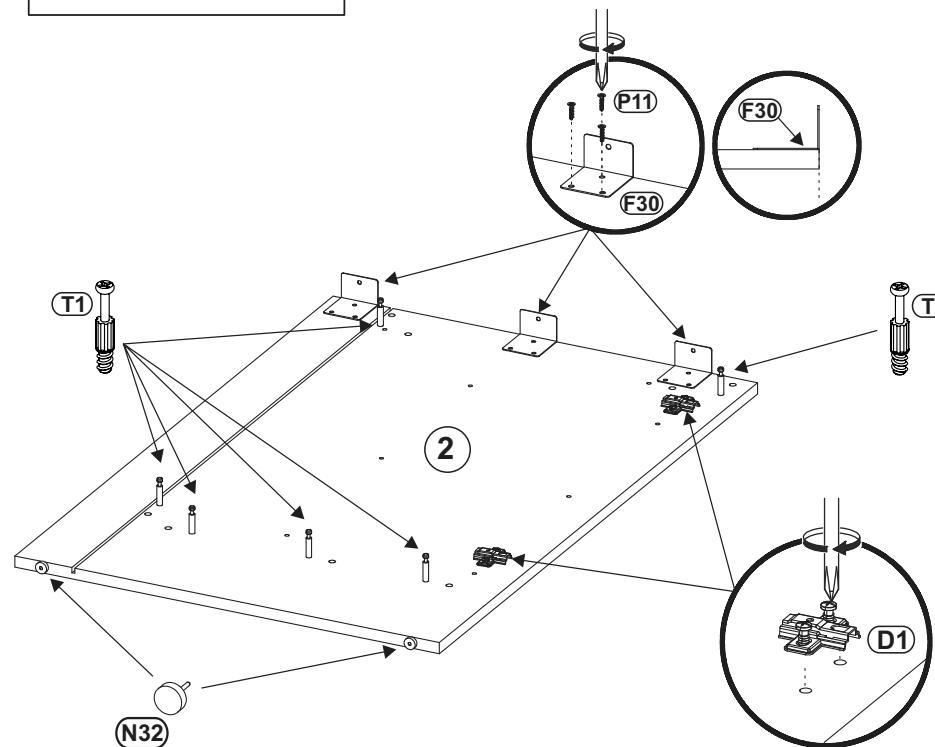
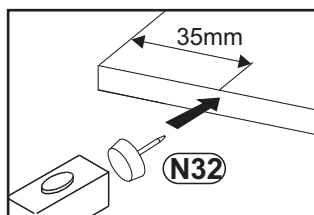
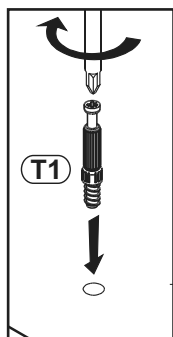
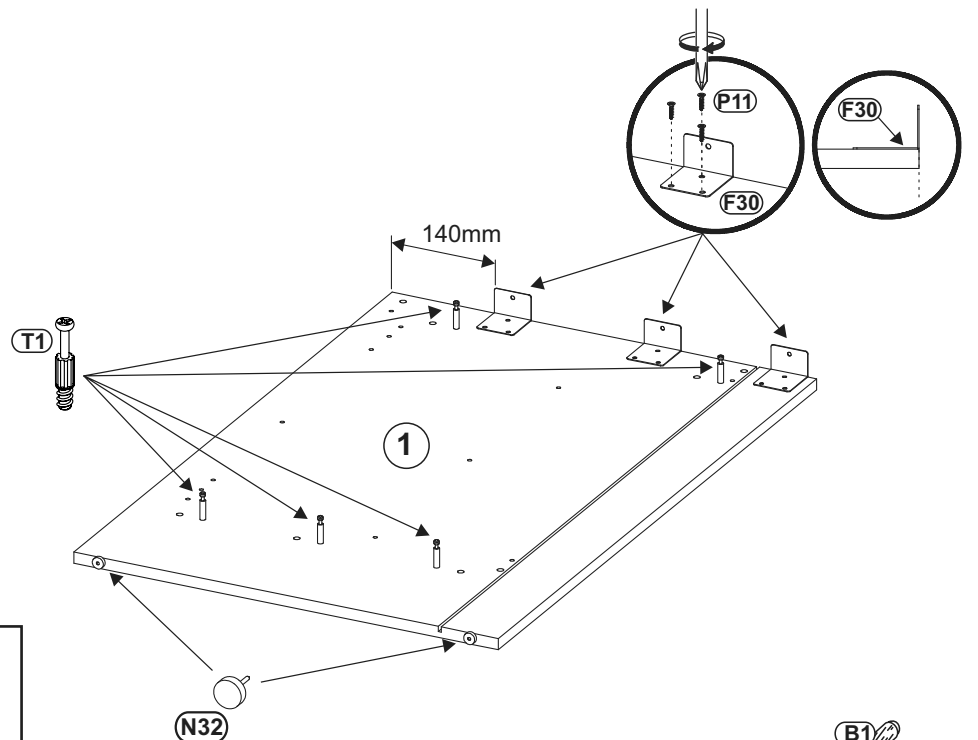
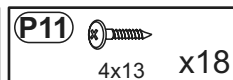
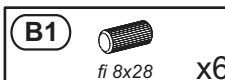
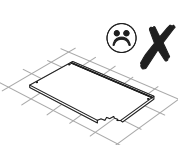
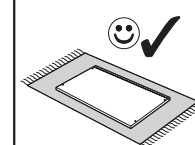
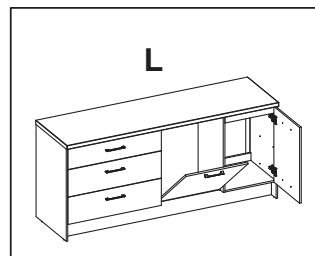
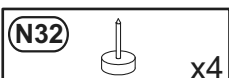
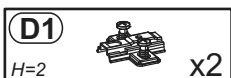
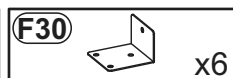
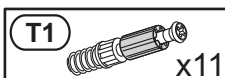

1

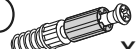

2

- F30**  x4
- T1**  x11
- B1**  fi 8x28 x16
- P11**  4x13 x12

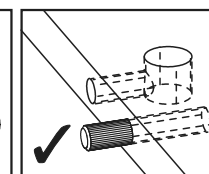
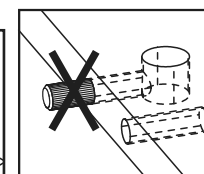
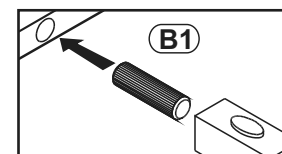
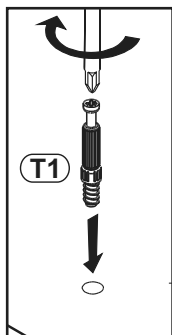
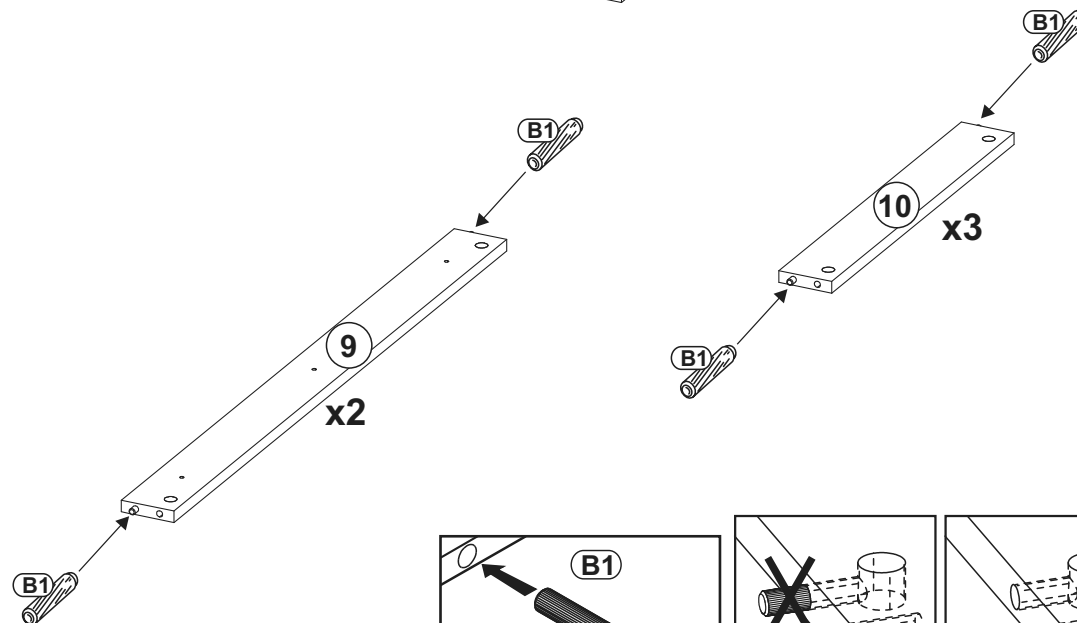
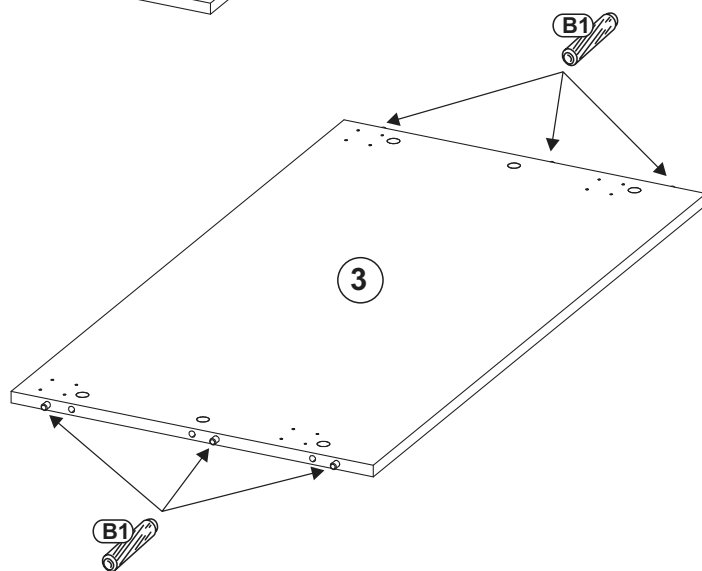
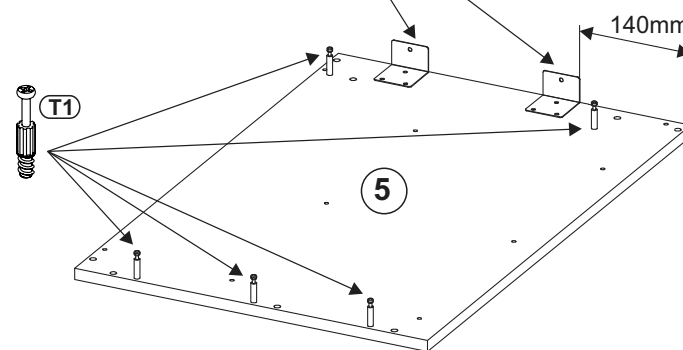
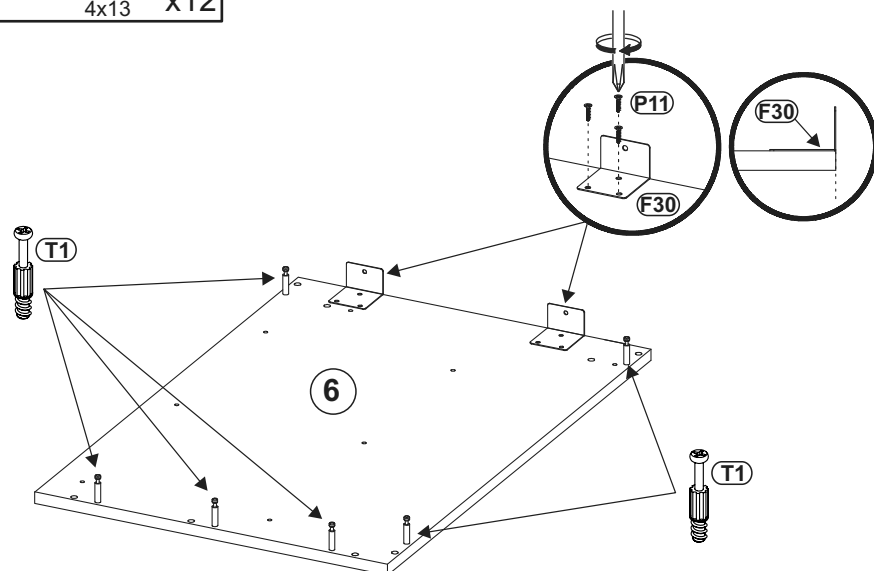
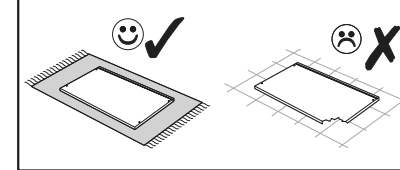
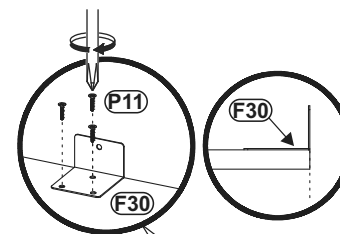
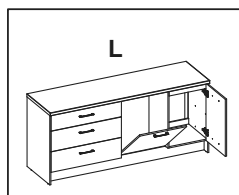

3

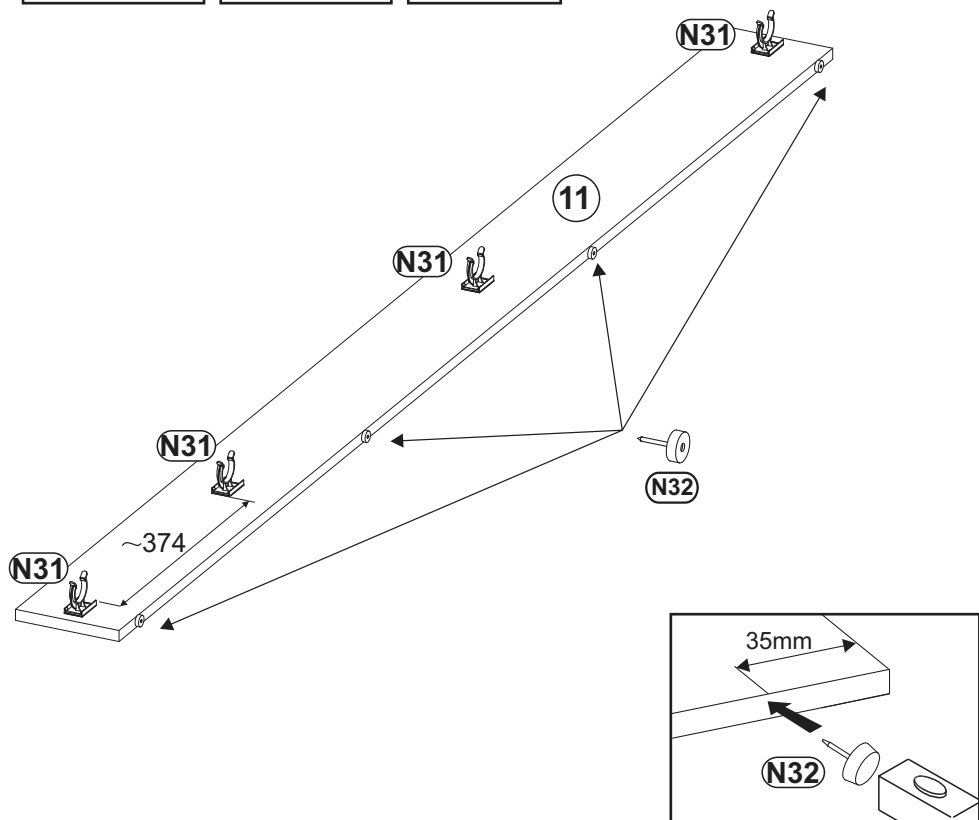
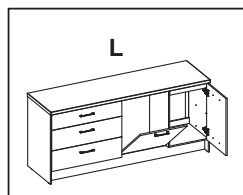
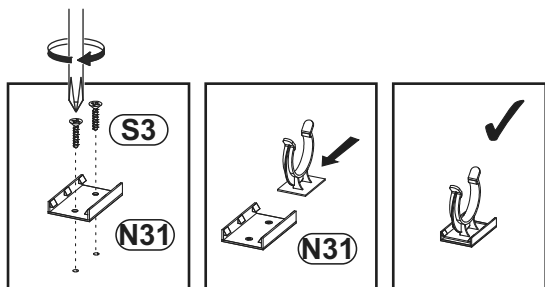
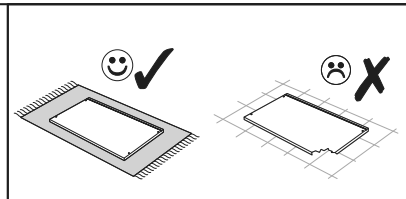
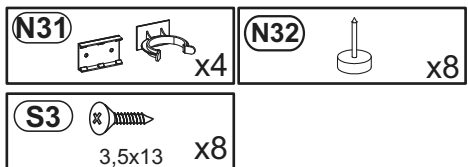

4

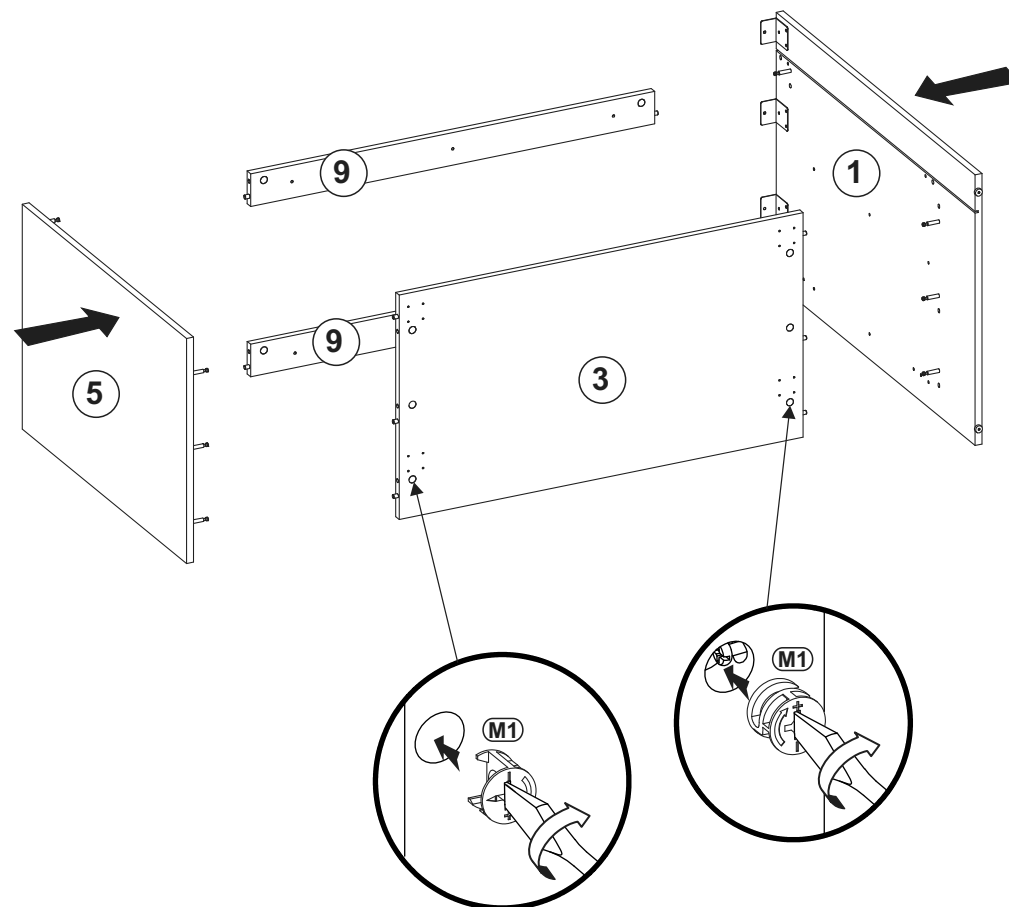
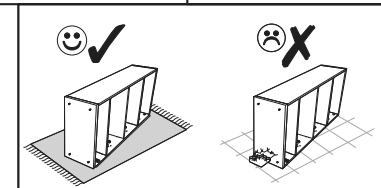
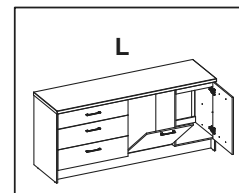

5

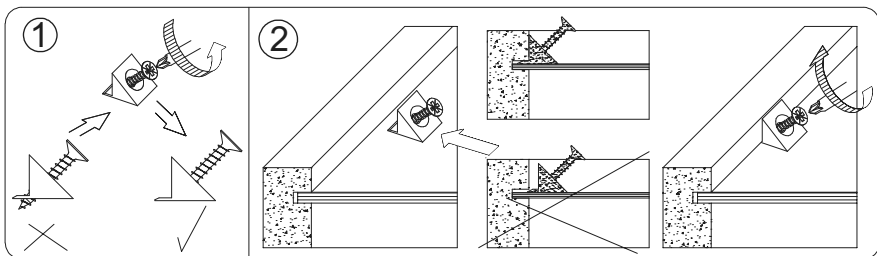
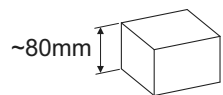
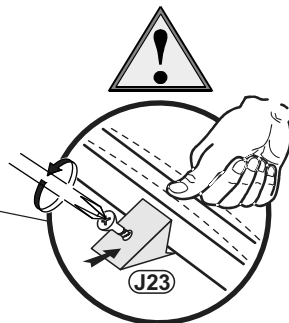
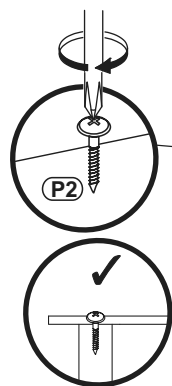
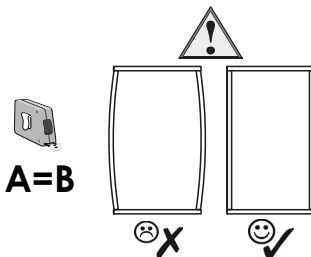
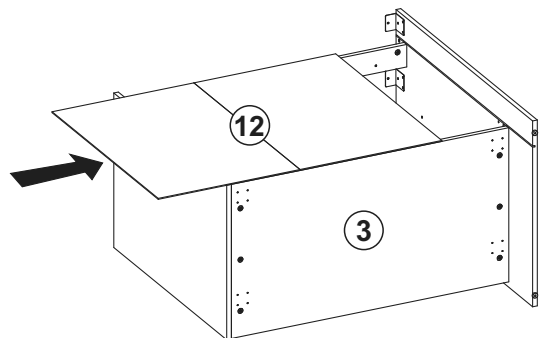
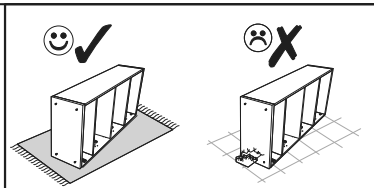
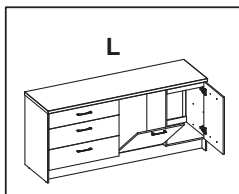
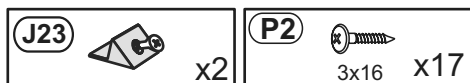

6

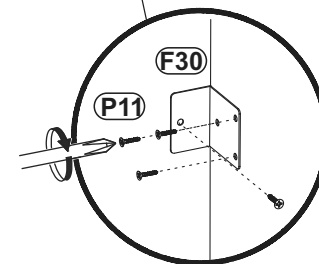
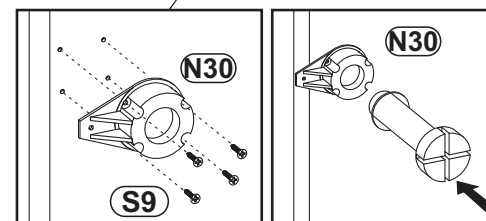
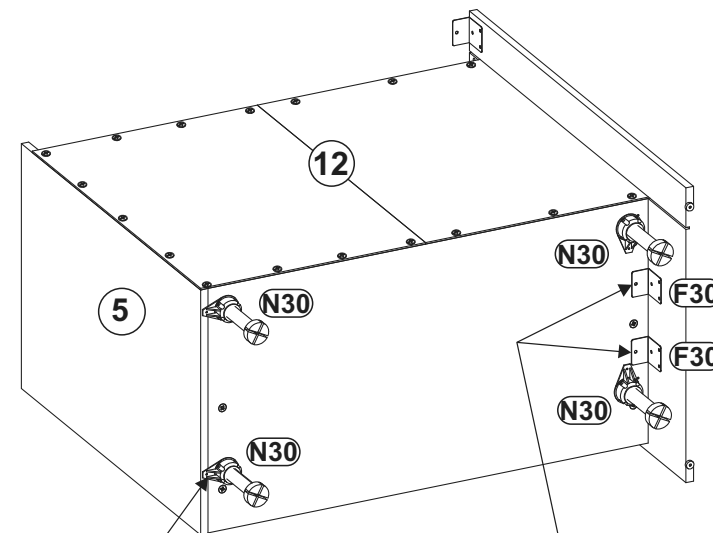
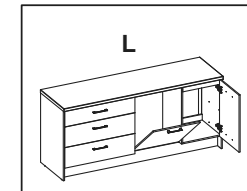
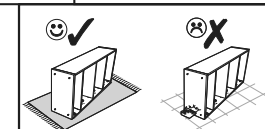
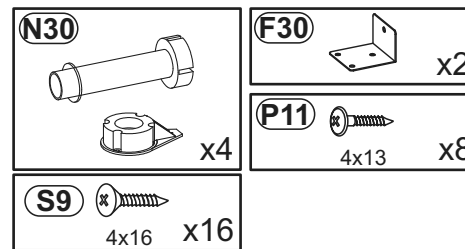

7

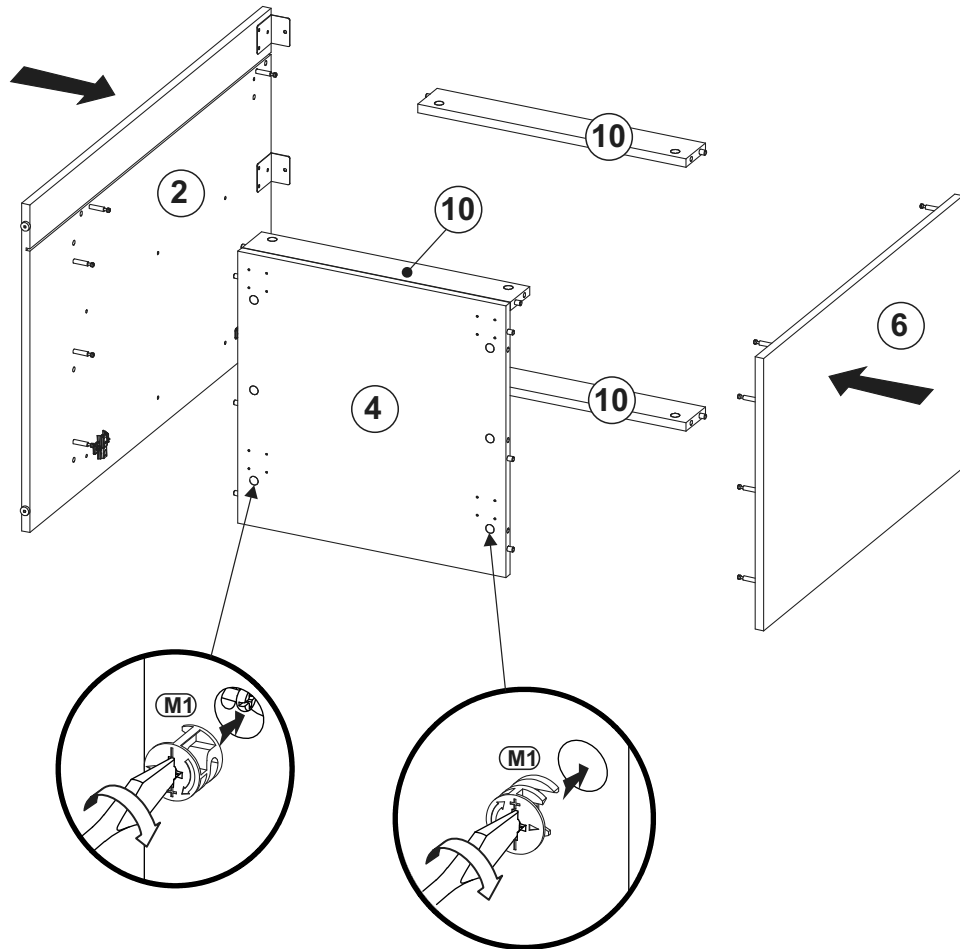
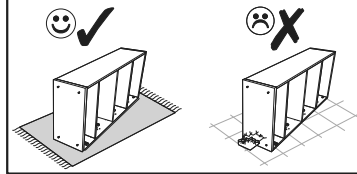
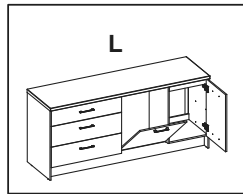

8

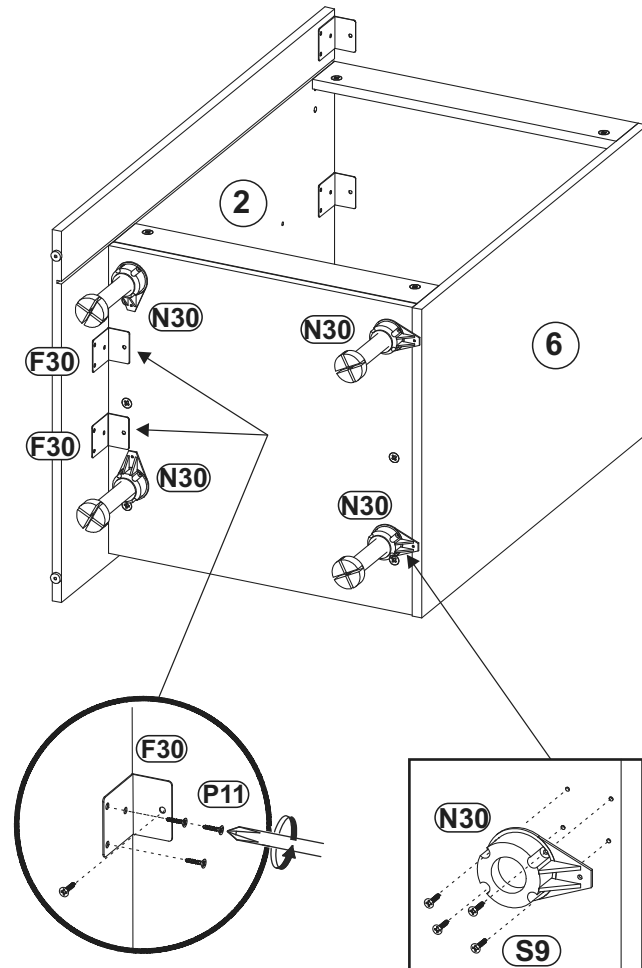
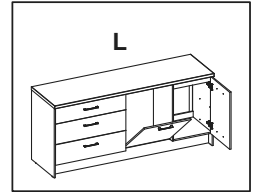
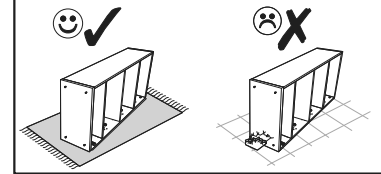
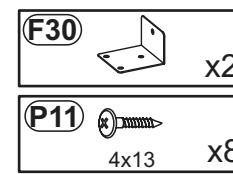
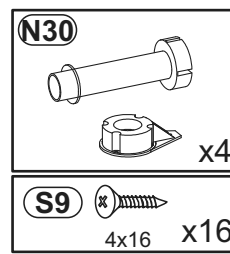



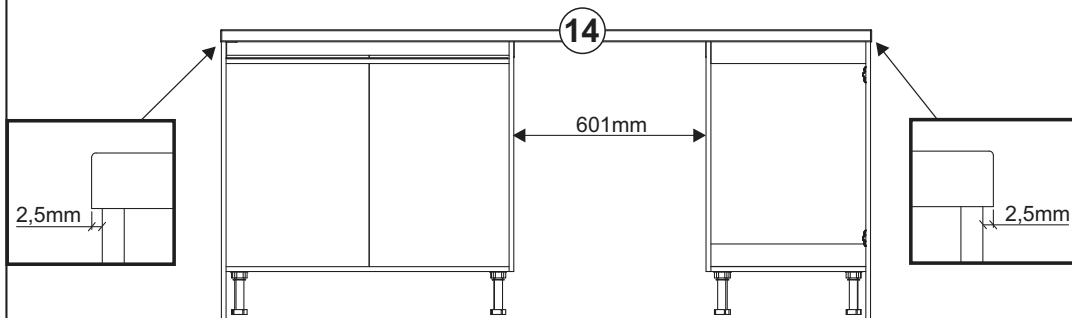
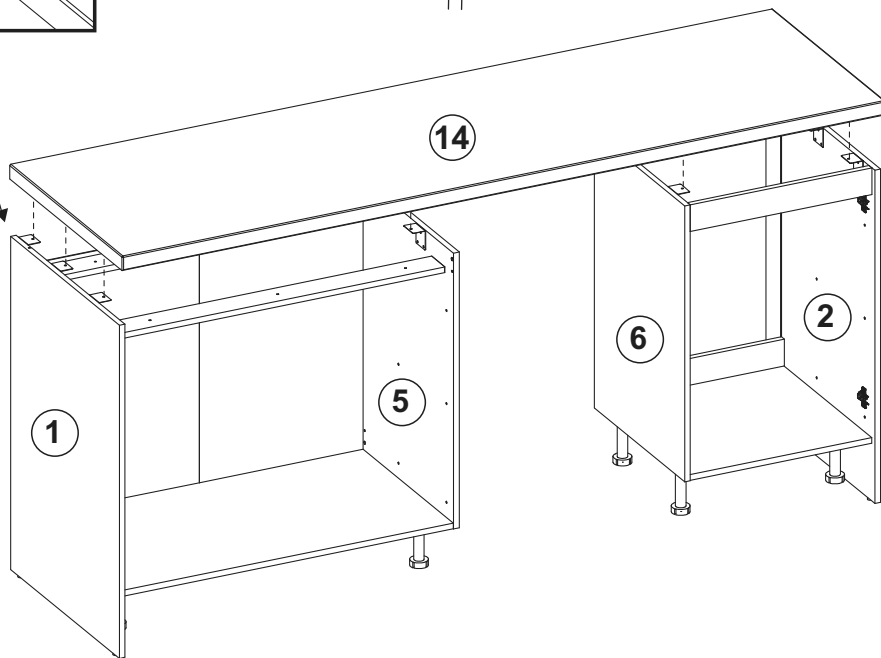
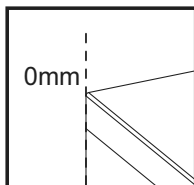
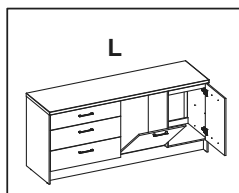
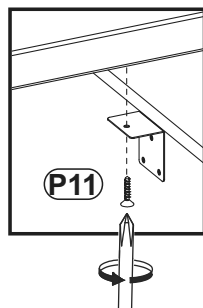

9

P11  4x13 x10



10

R44  L-450 x3
E1  6.3x13 x12

J11  x2
P16  4x16 x4
T17  x2

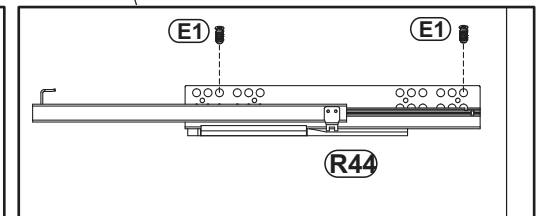
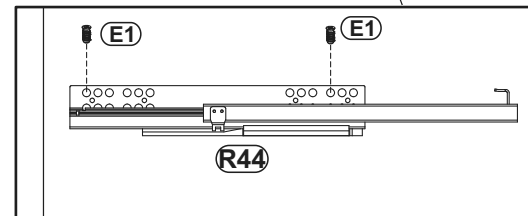
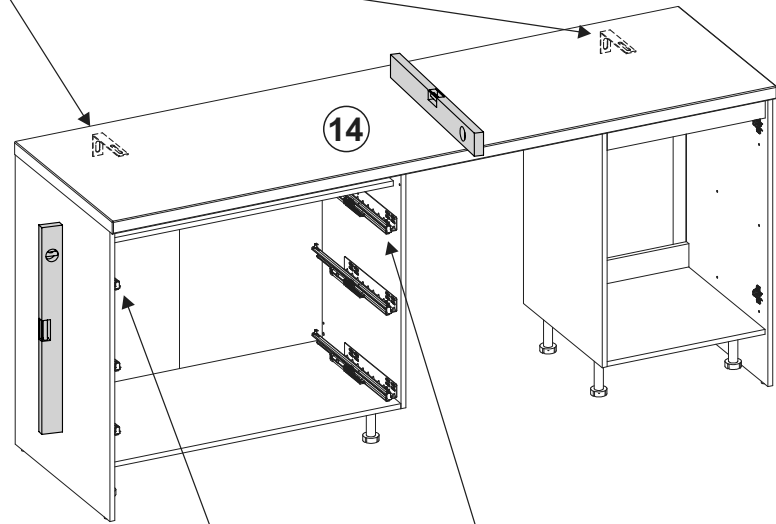
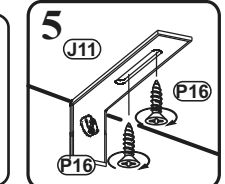
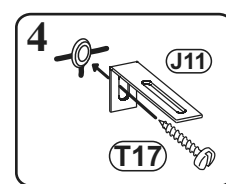
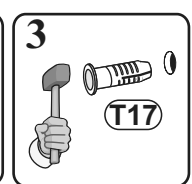
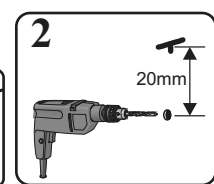
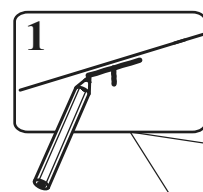
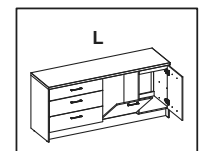
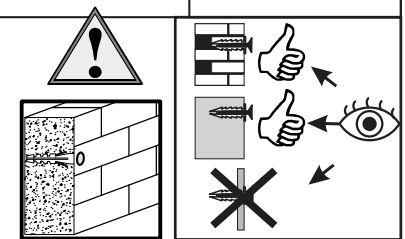

11

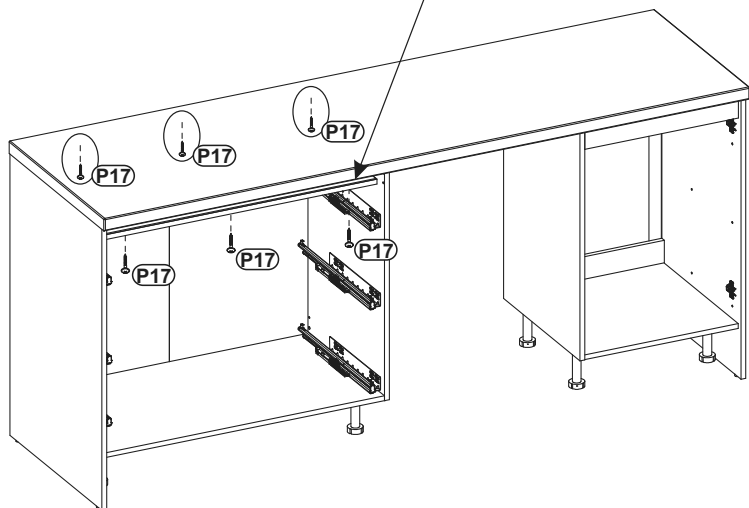
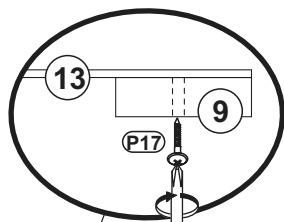
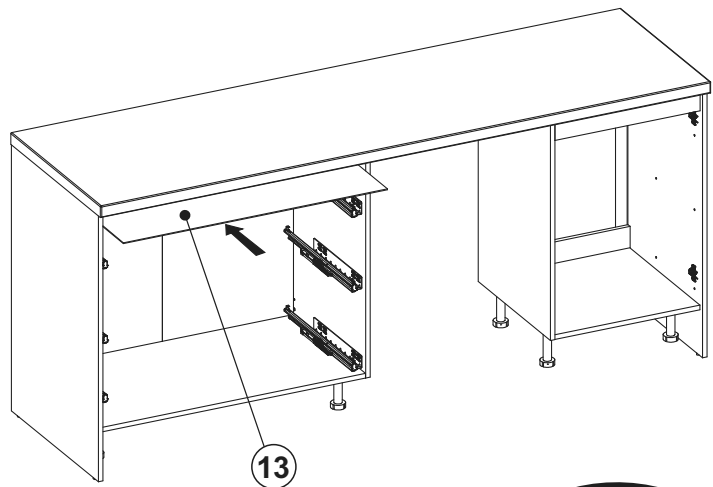
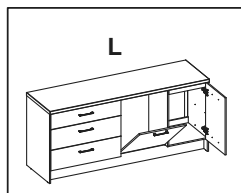
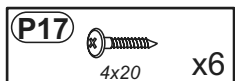

12

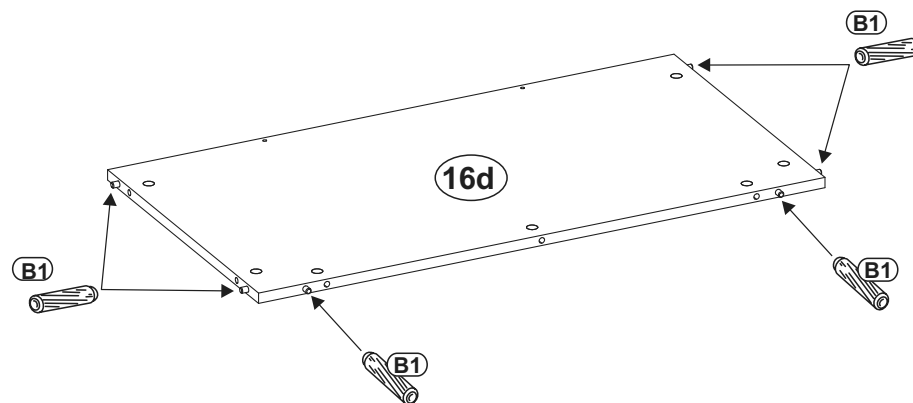
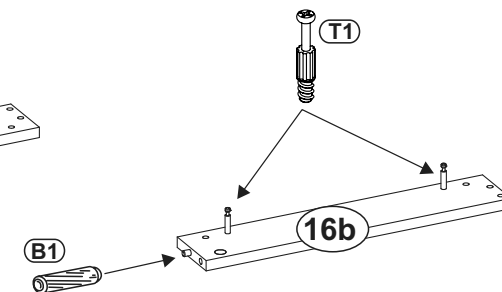
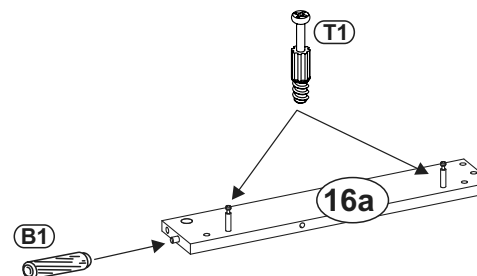
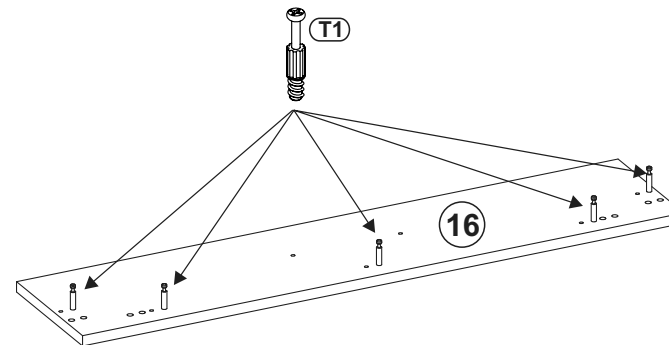
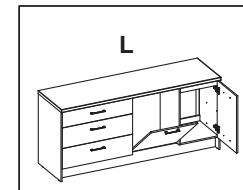
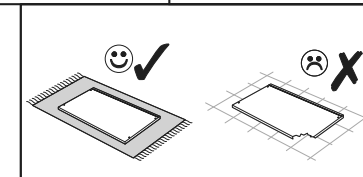
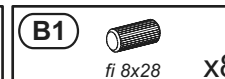
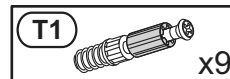

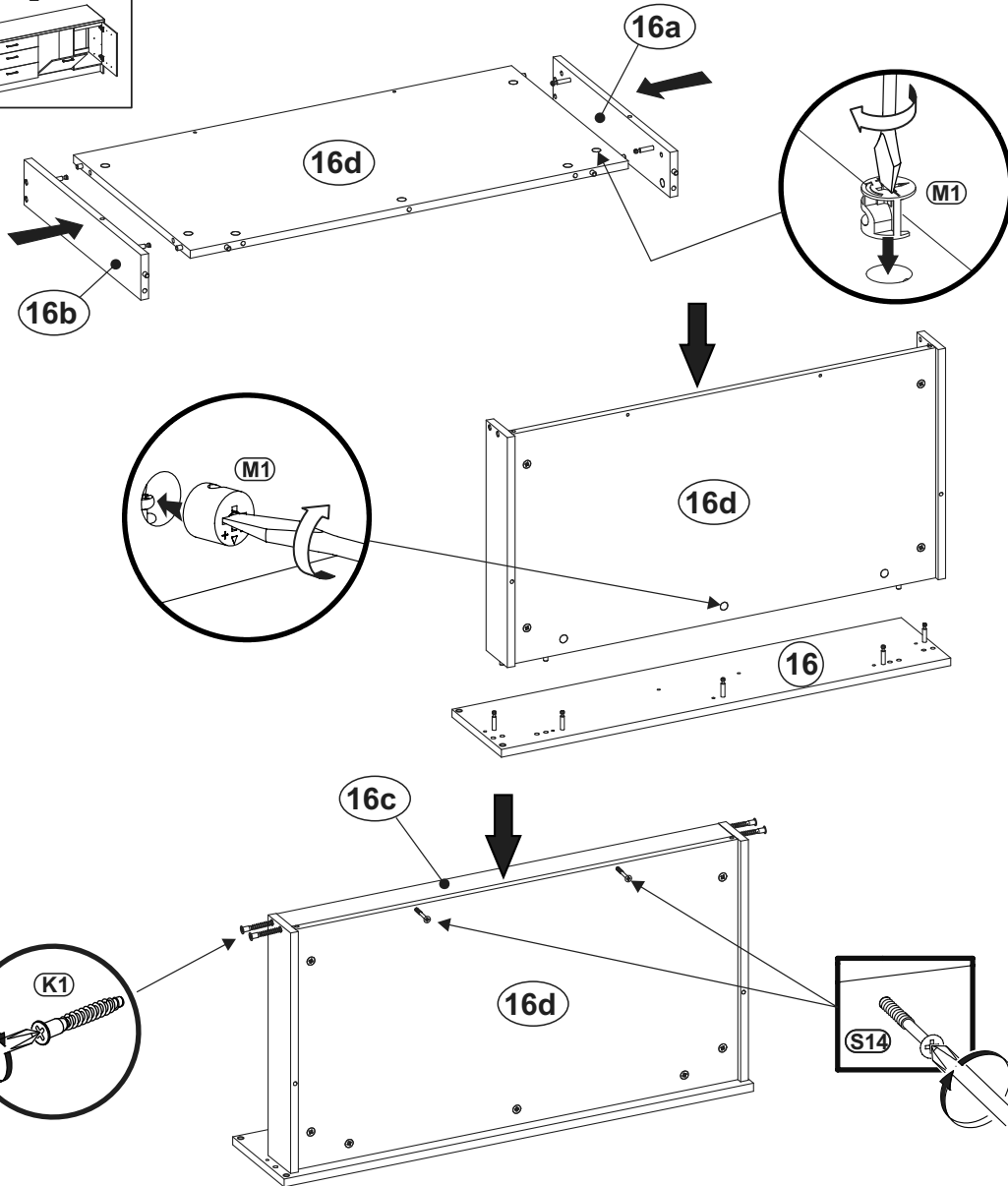
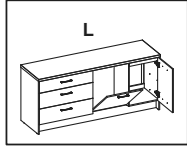
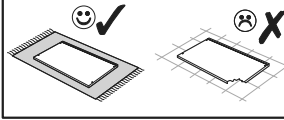
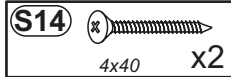
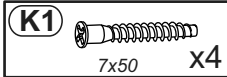

13

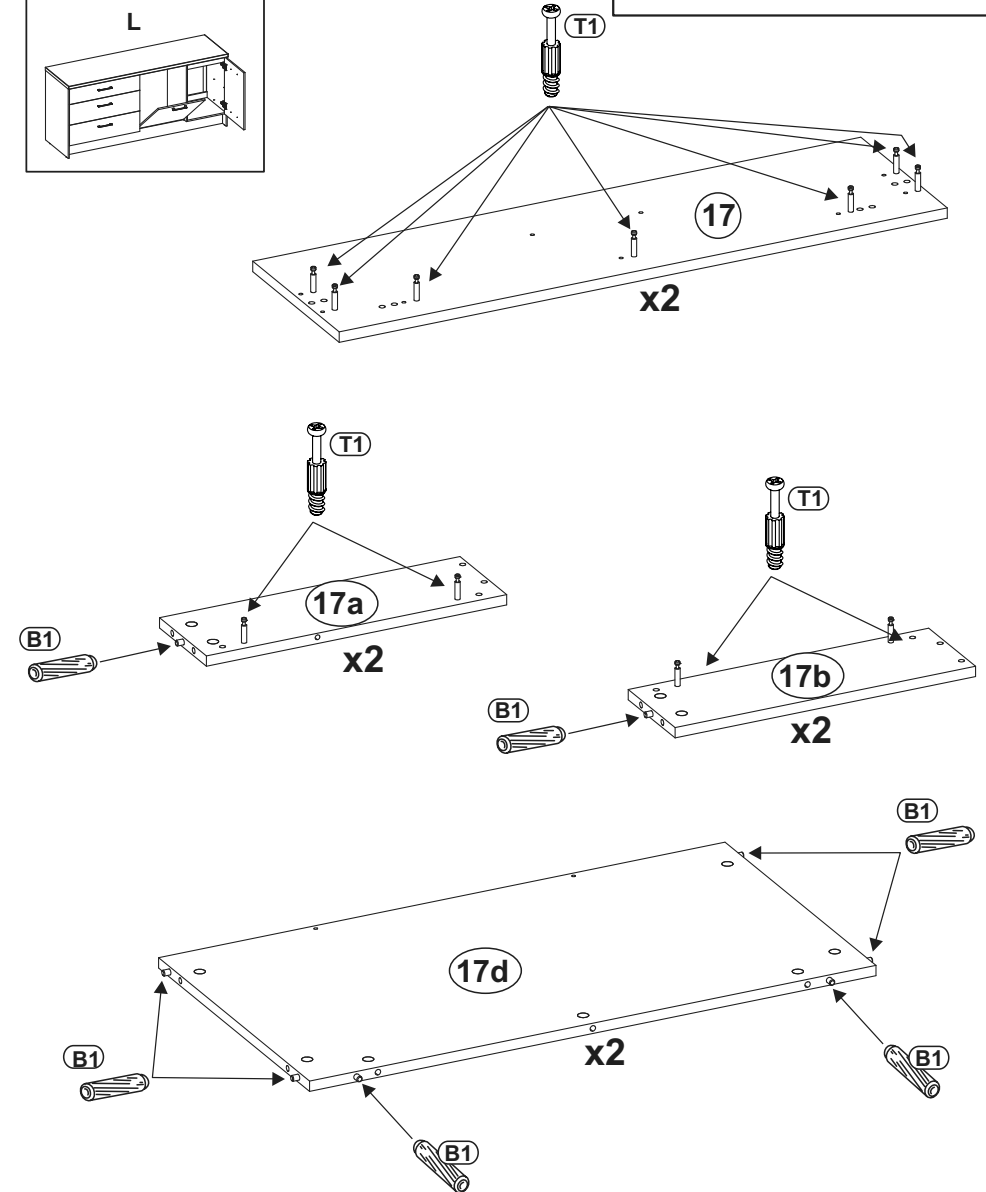
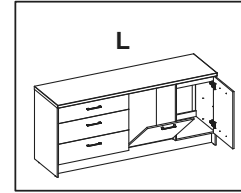
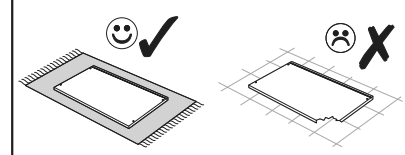
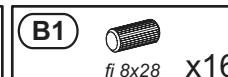
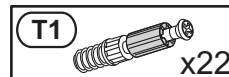

14



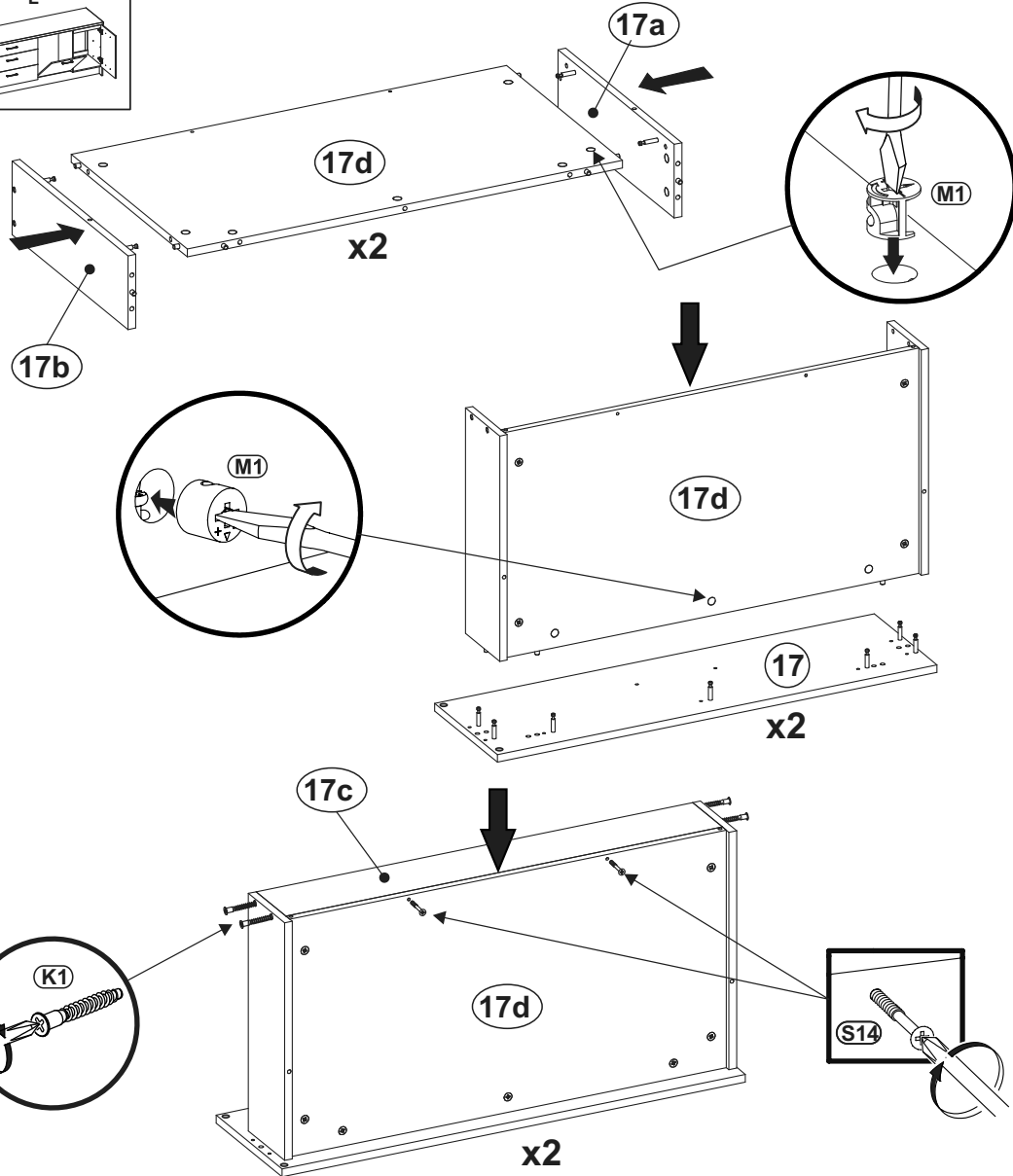
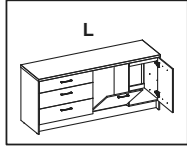
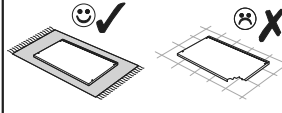

15

- M1**  x22
- K1**  7x50 x8
- S14**  4x40 x4

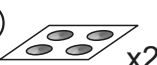
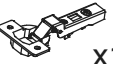

16

- Z1**  x1
- L13**  SJ x2
- Z2**  x1
- S9**  4x16 x4

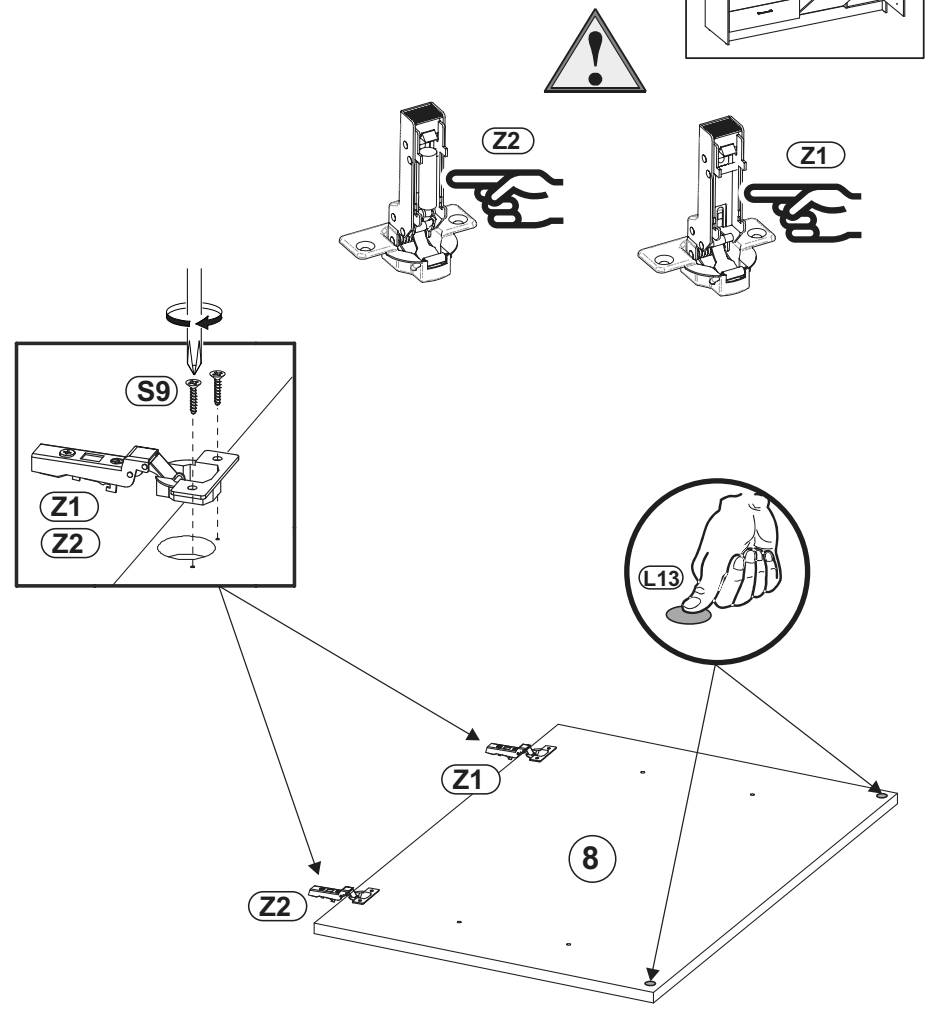
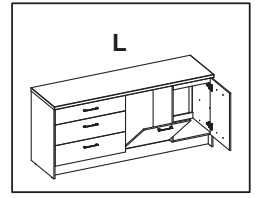
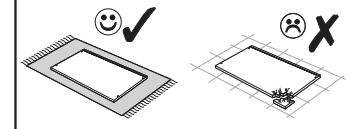

17

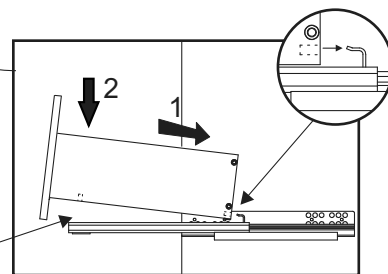
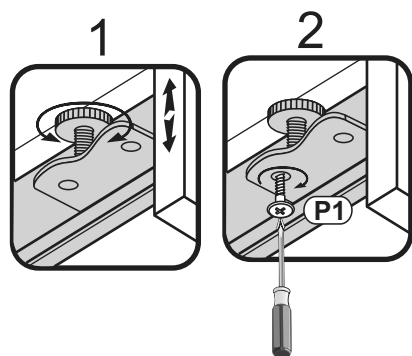
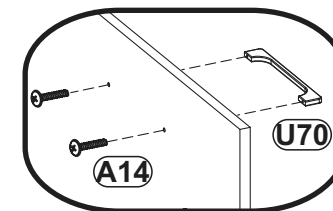
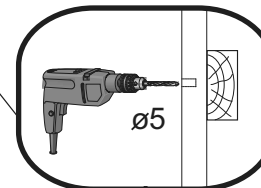
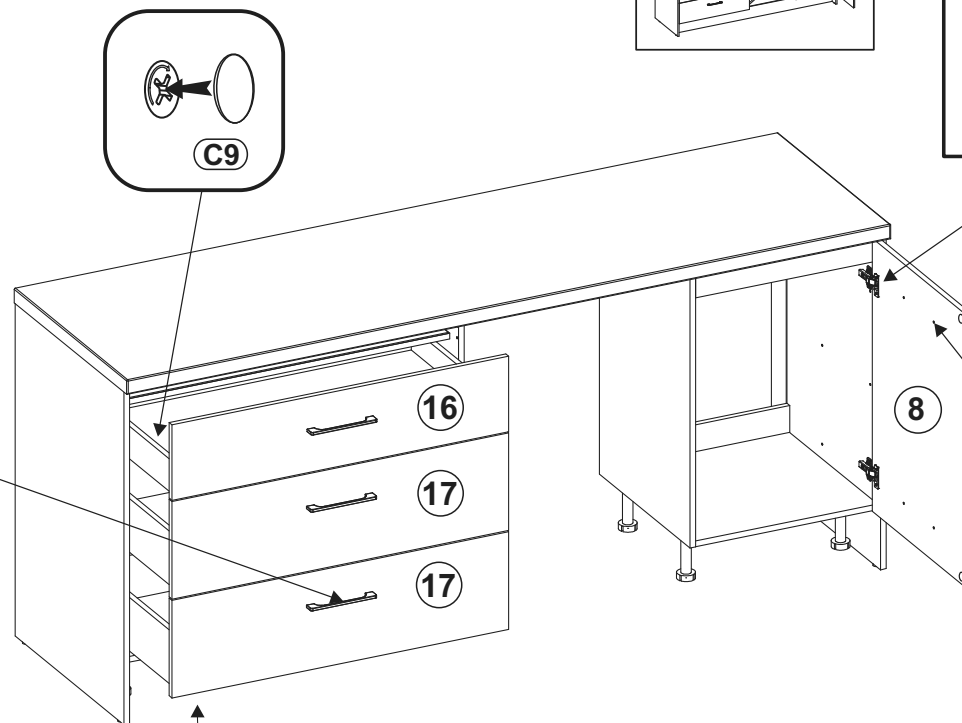
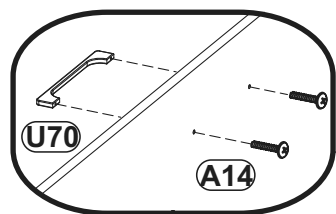
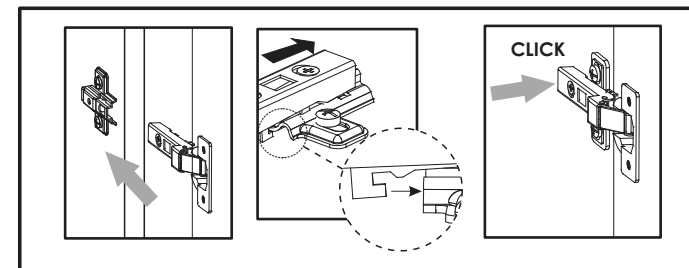
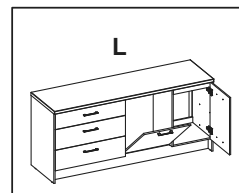
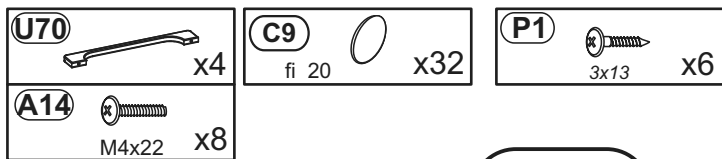

18

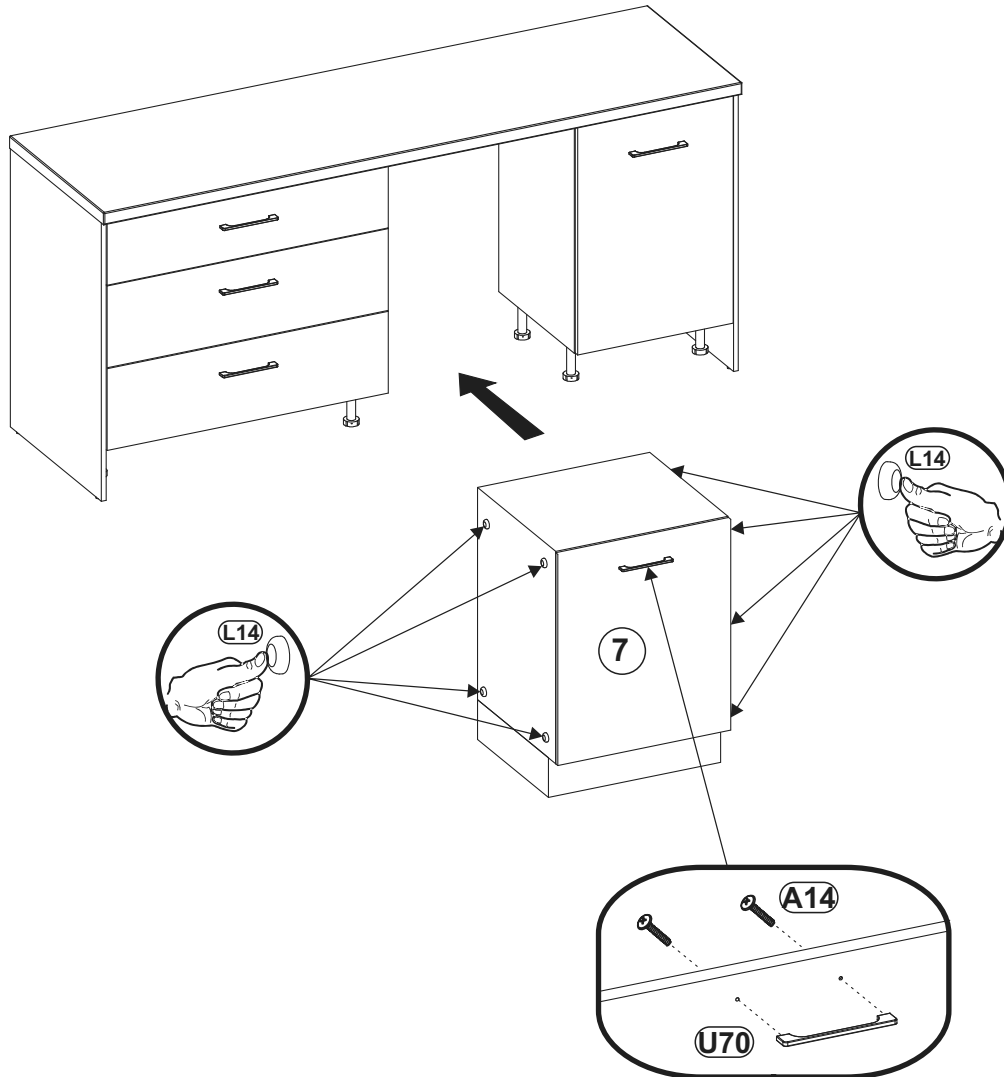
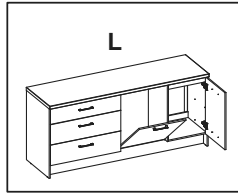
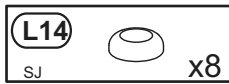
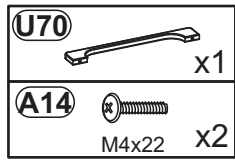

19

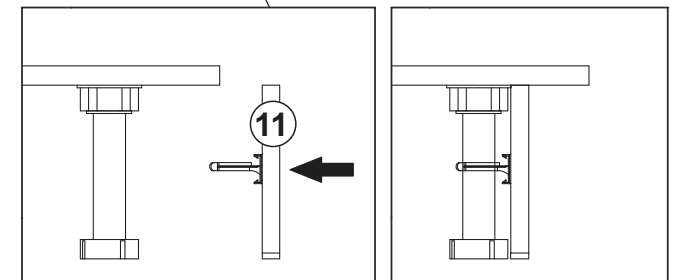
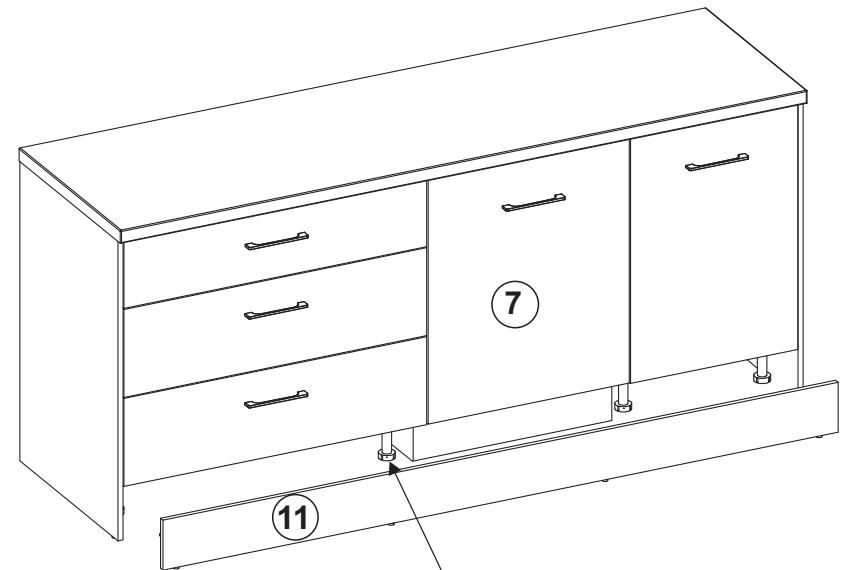
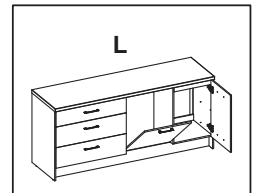

20

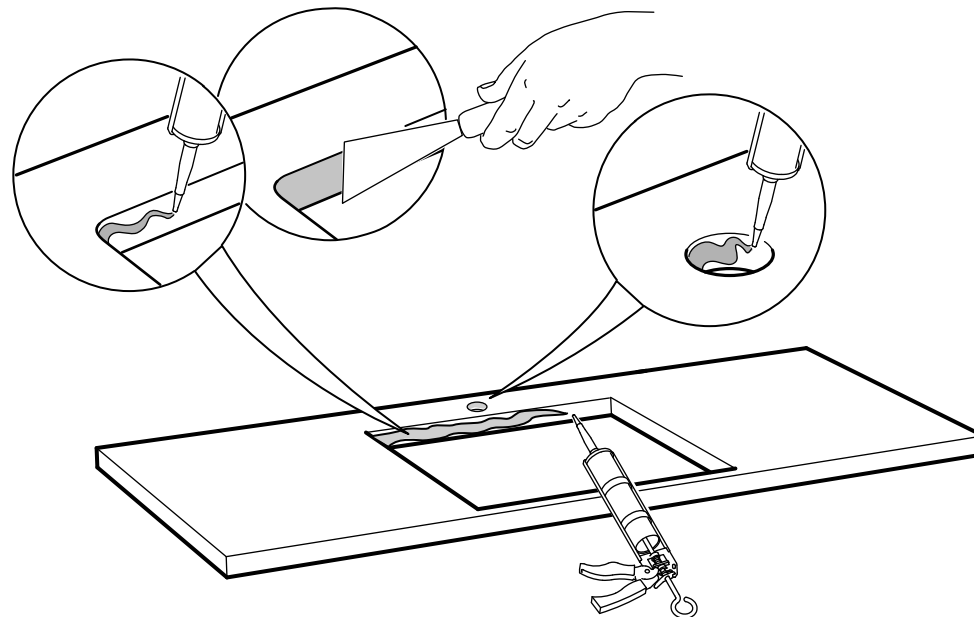
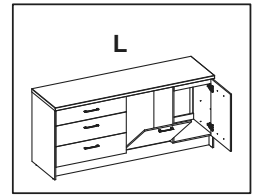
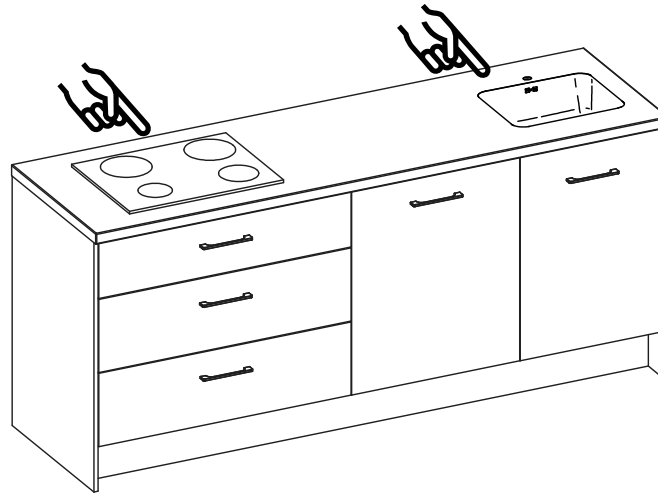

1

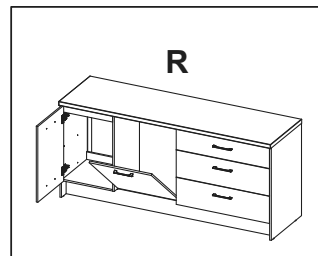
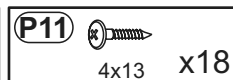
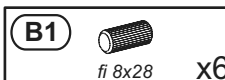
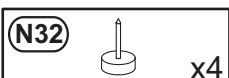
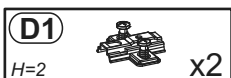
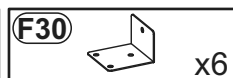
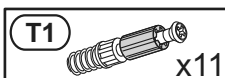

47/68 - 58/68

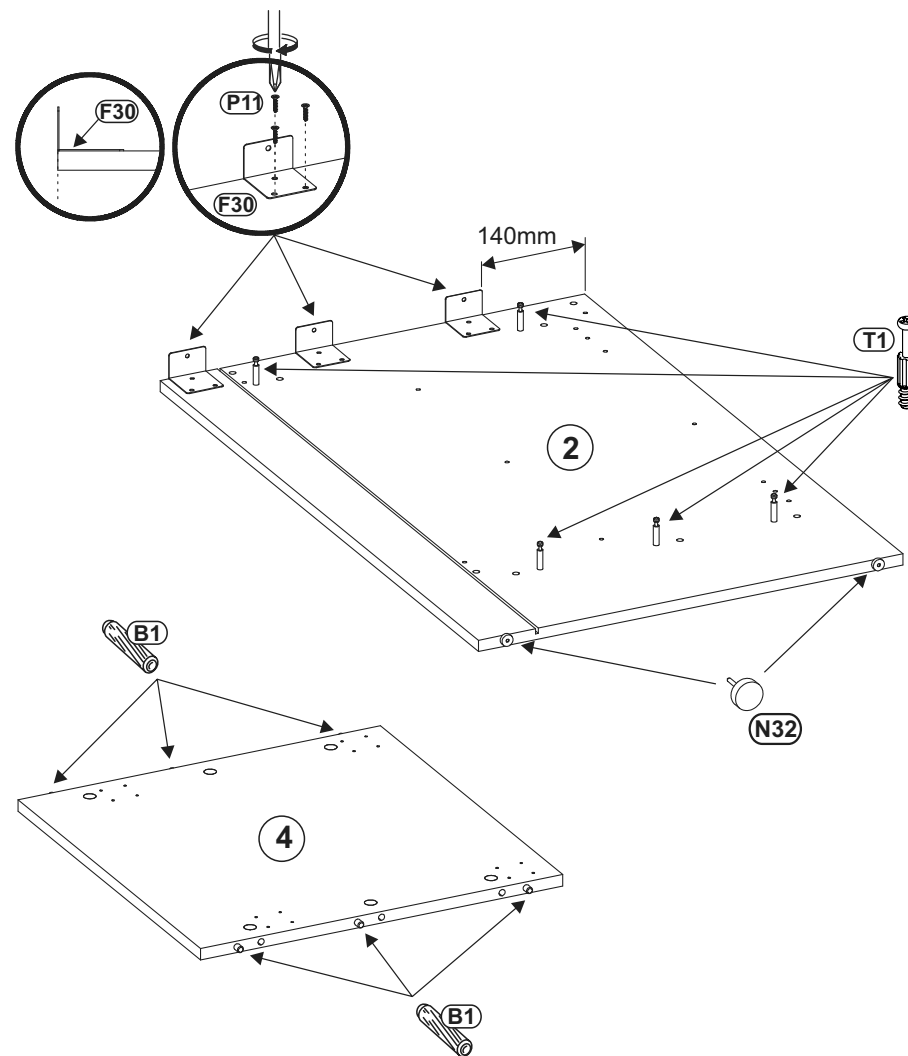
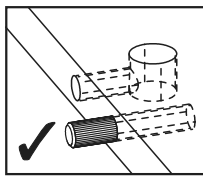
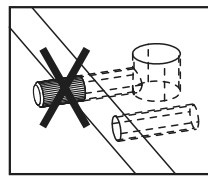
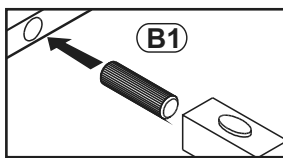
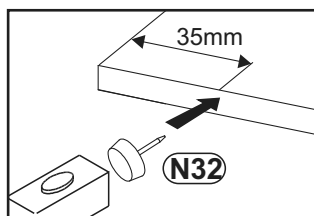
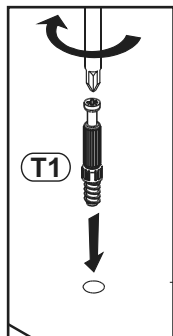
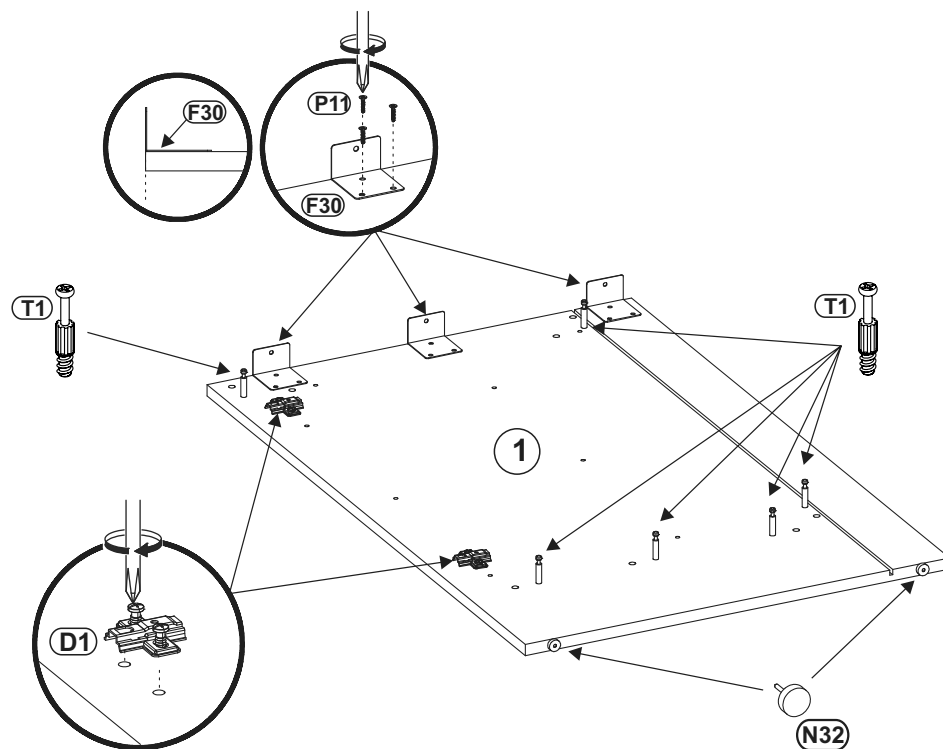
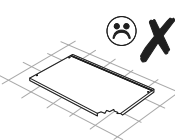
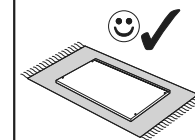

2

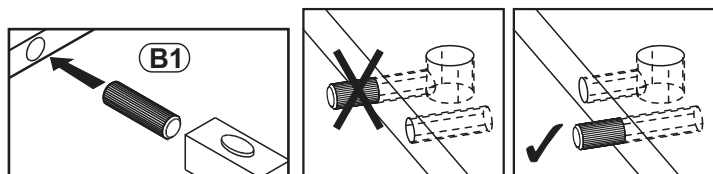
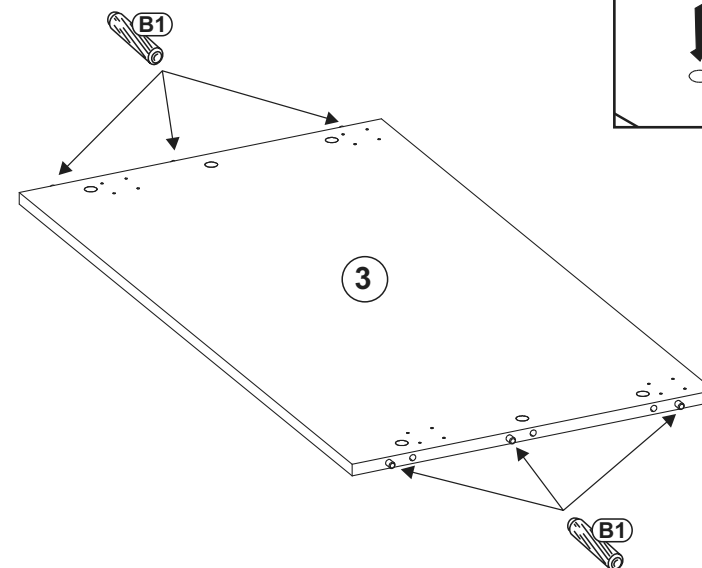
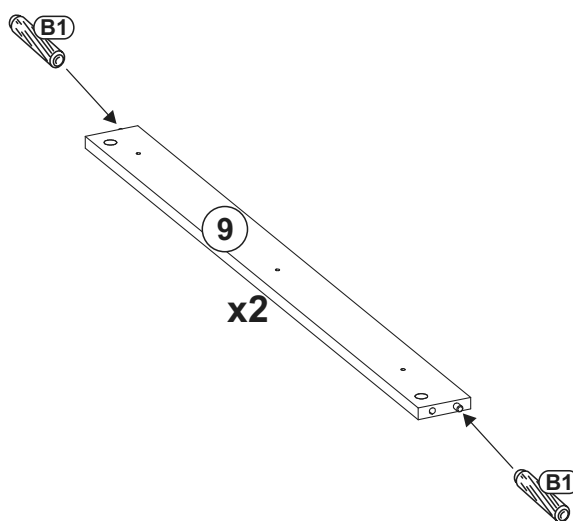
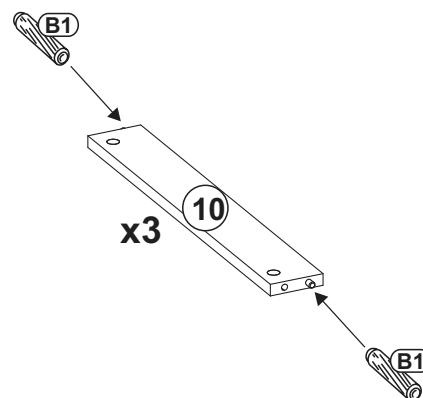
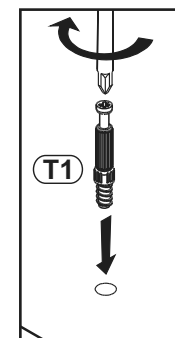
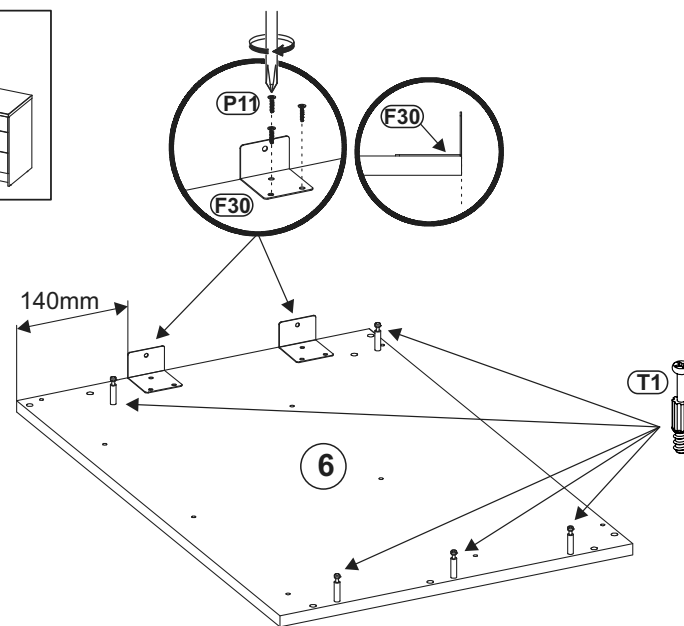
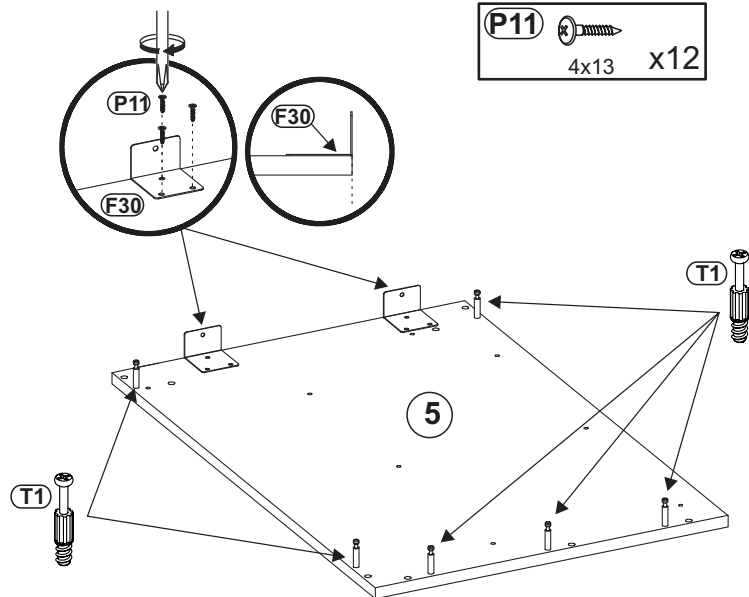
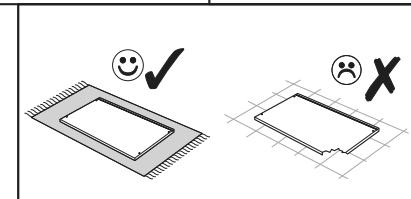
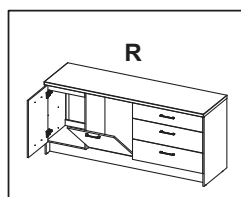
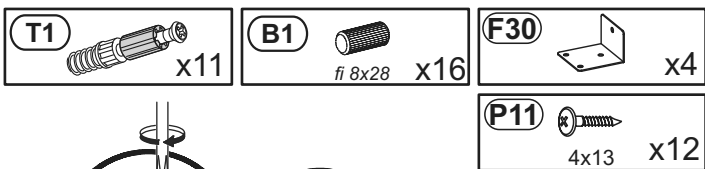

3

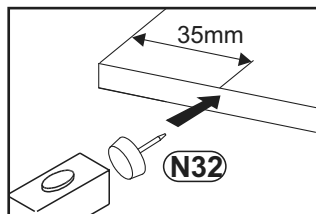
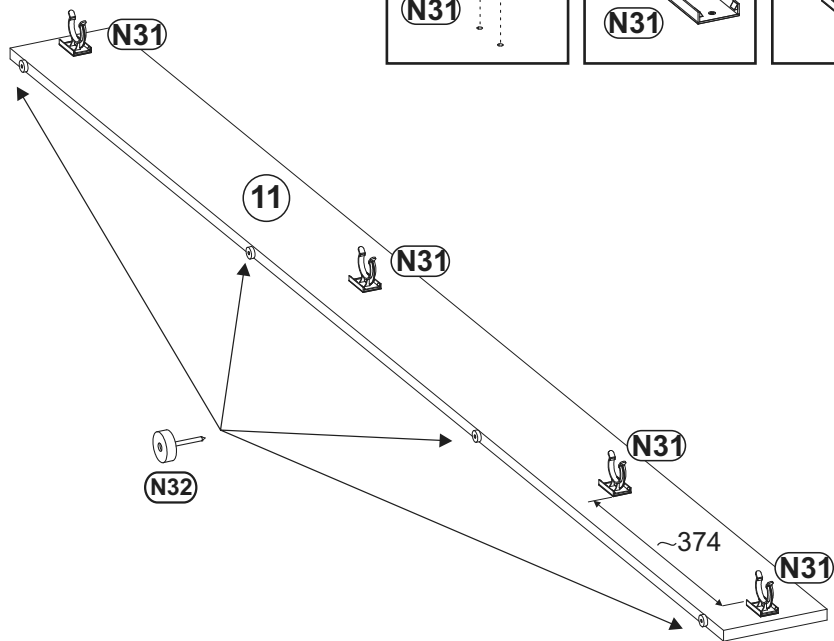
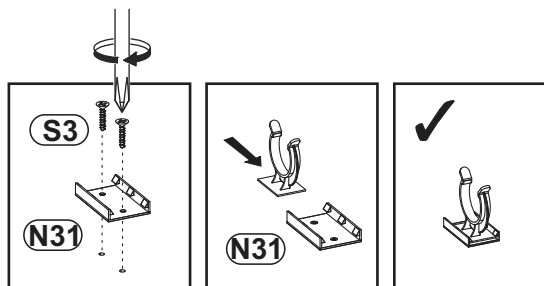
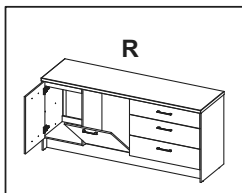
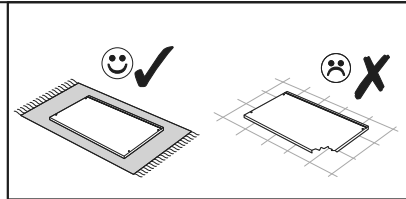
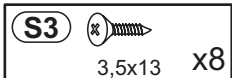
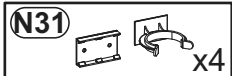

4

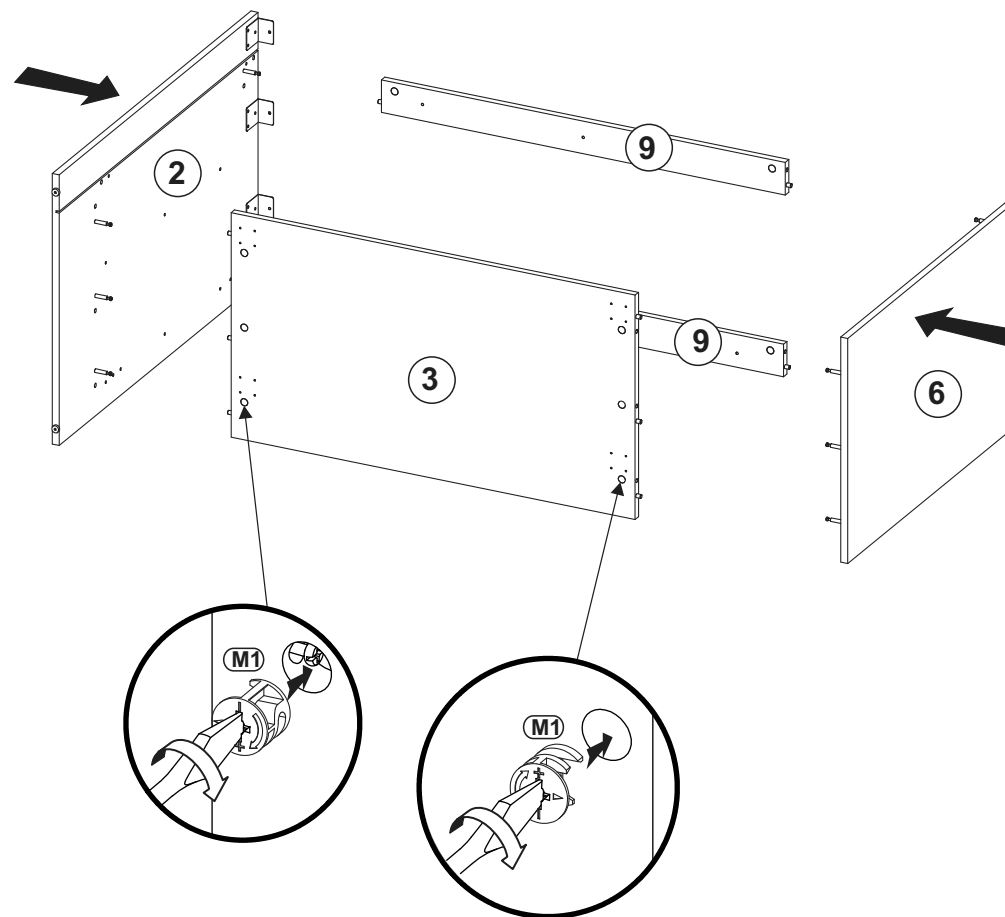
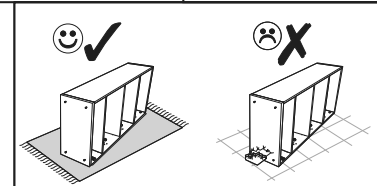
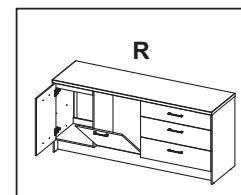

5

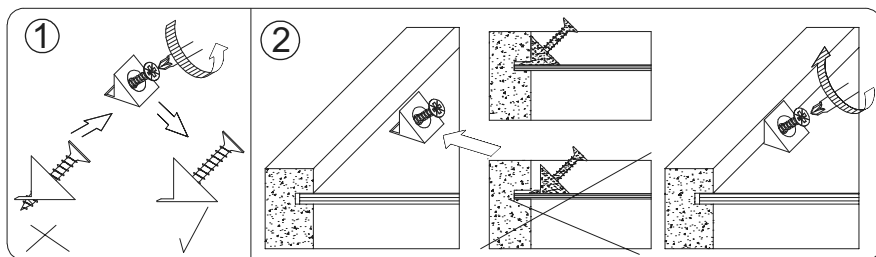
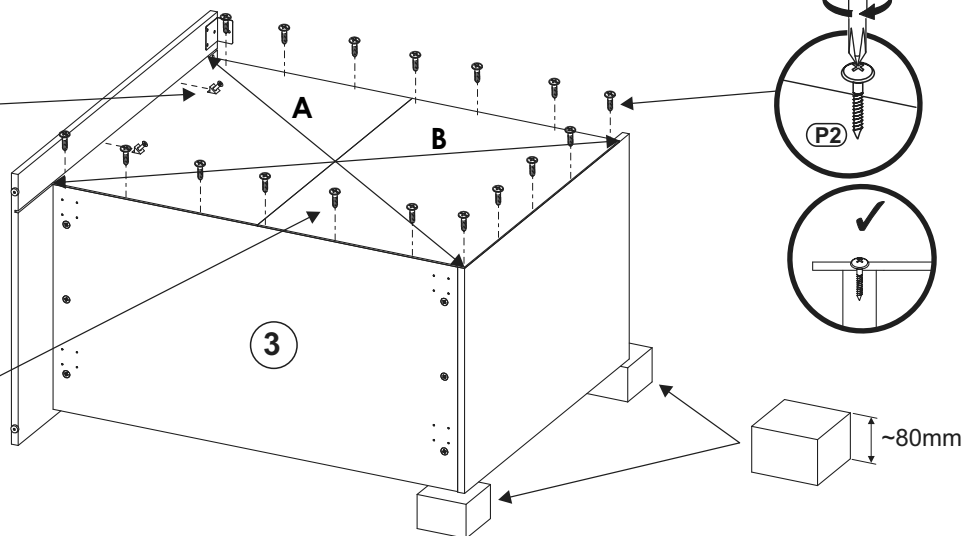
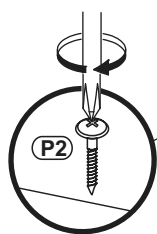
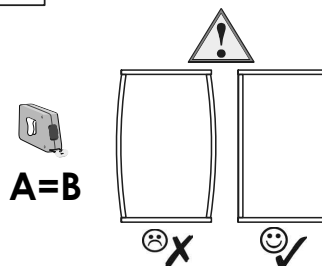
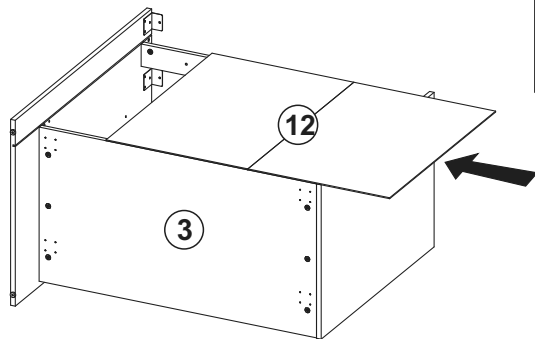
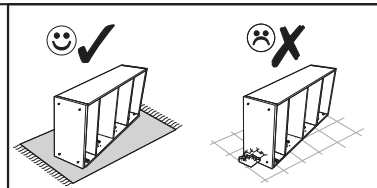
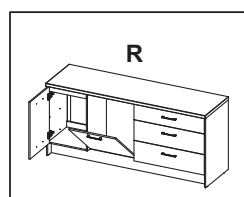
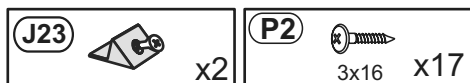

6

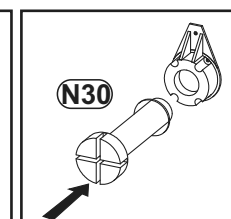
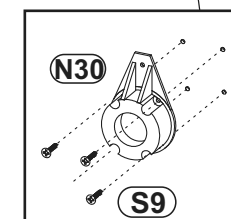
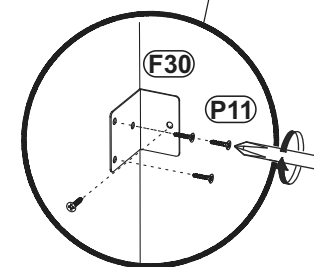
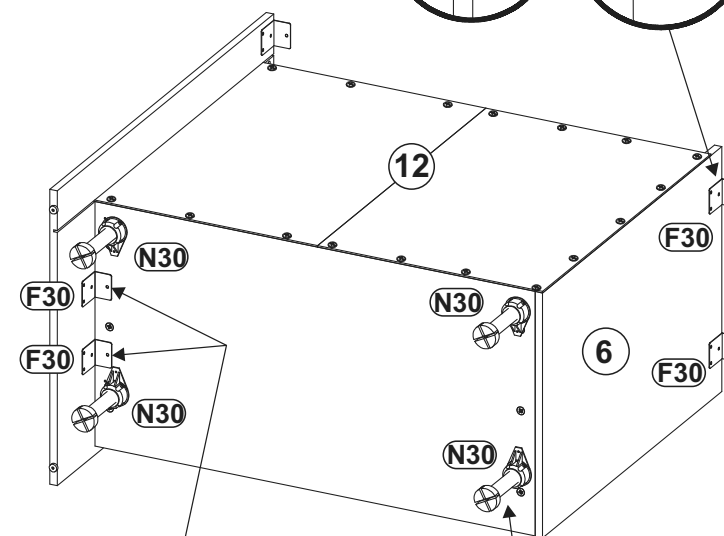
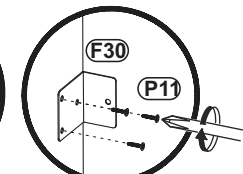
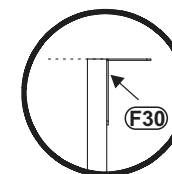
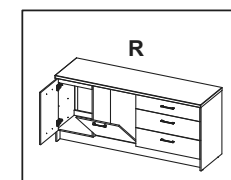
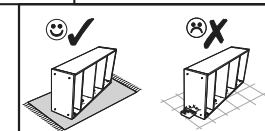
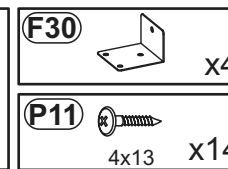
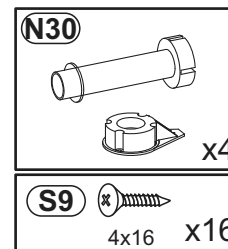

7

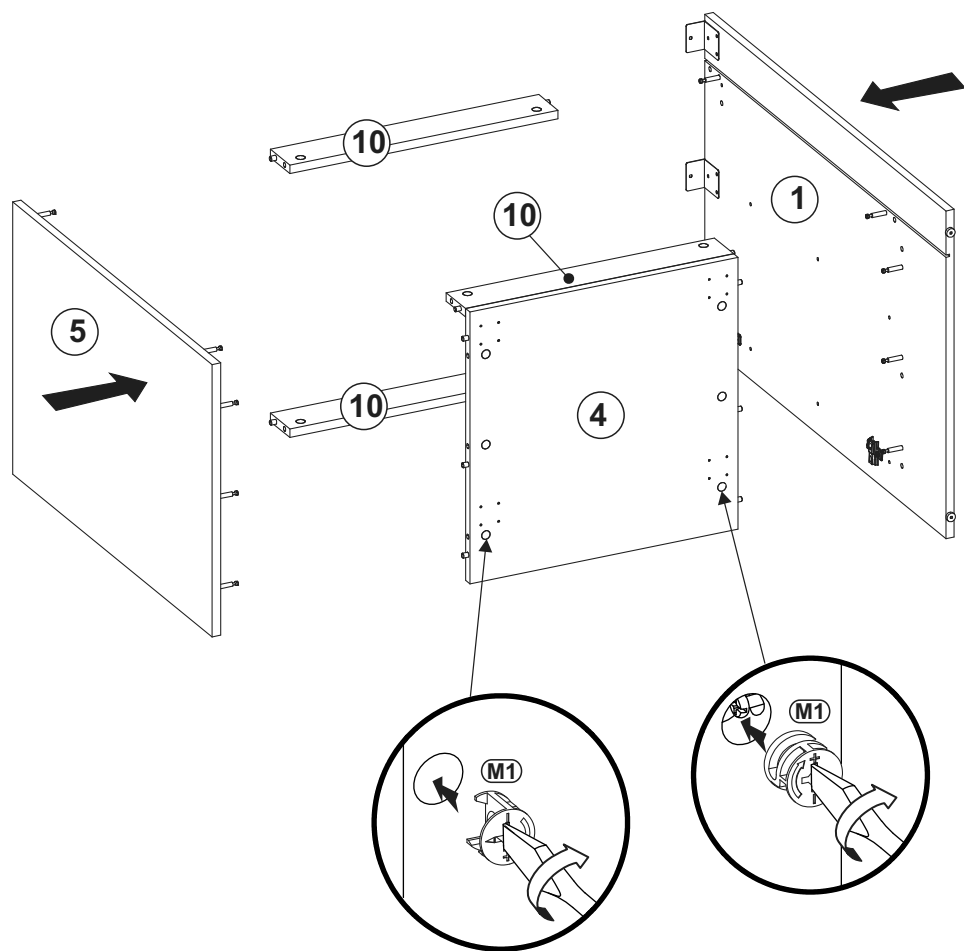
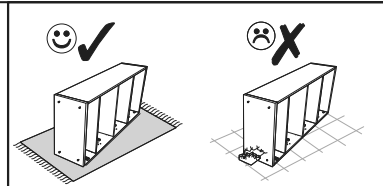
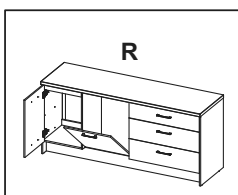

8

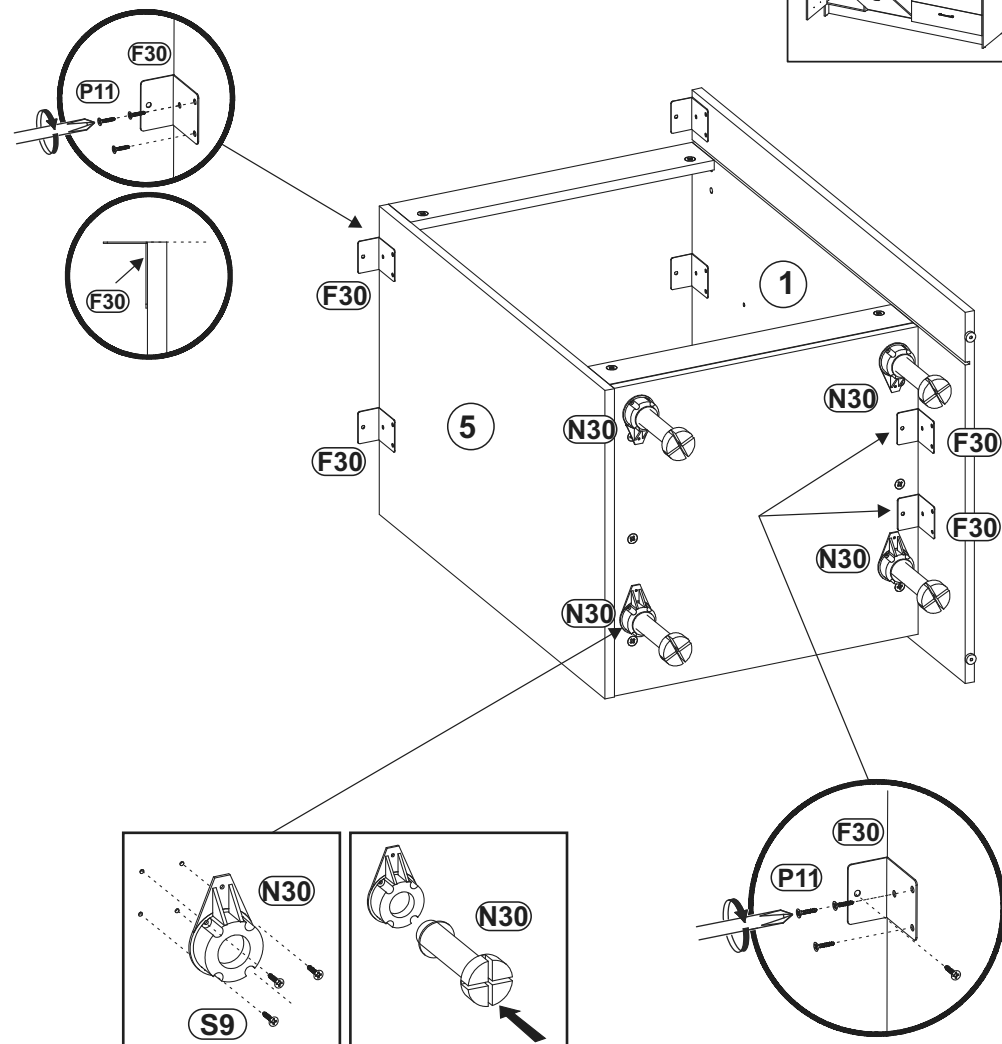
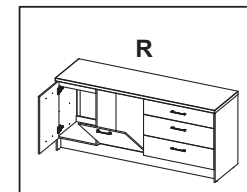
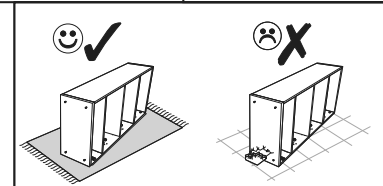
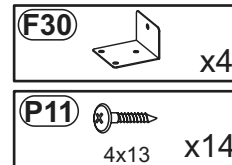
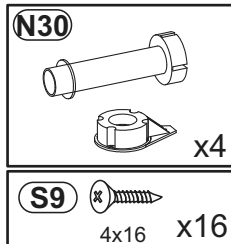

9

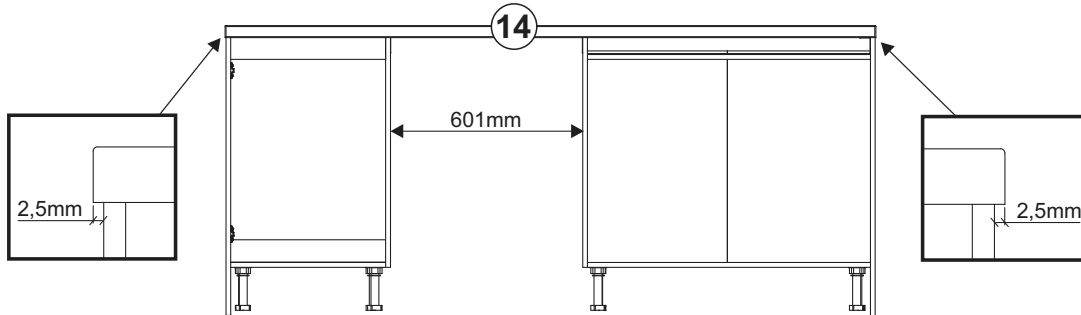
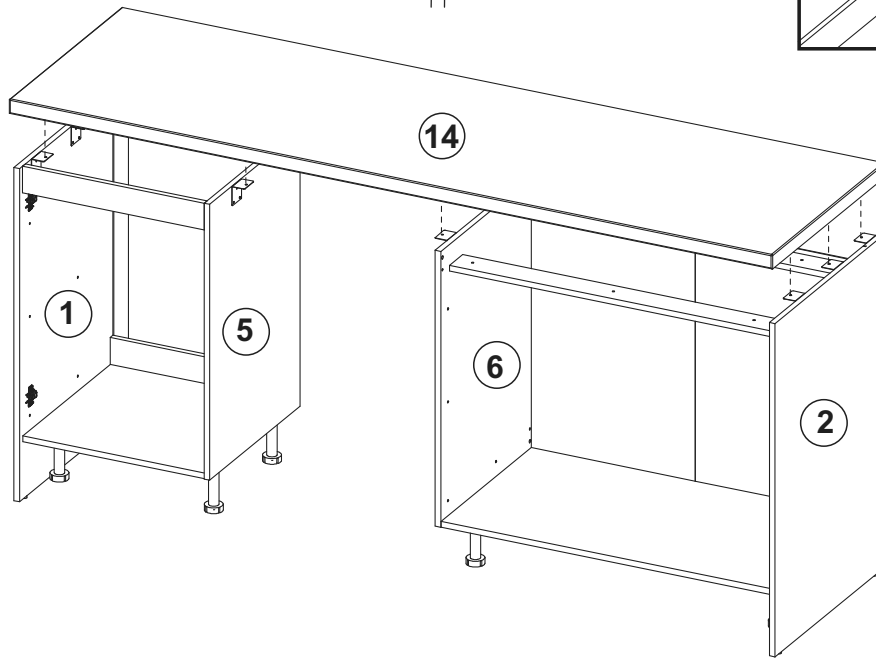
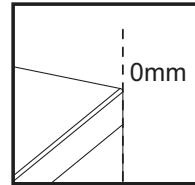
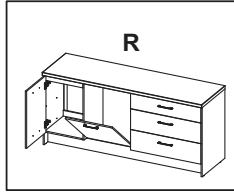
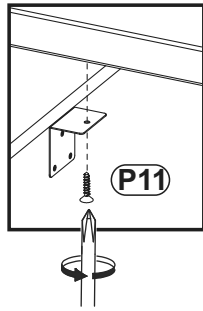
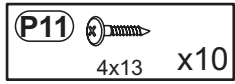

10

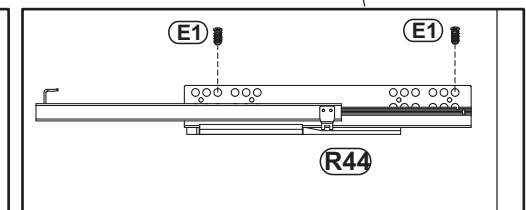
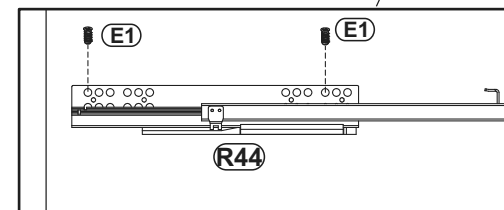
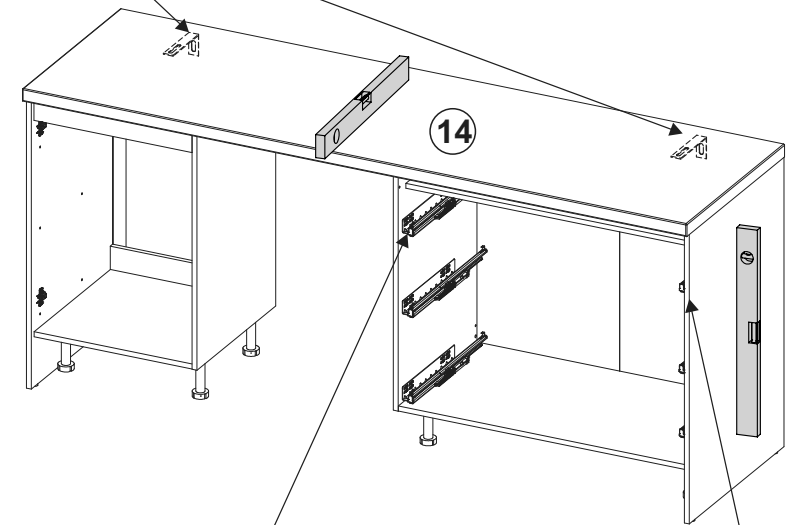
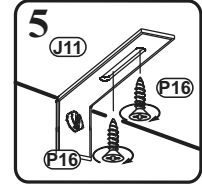
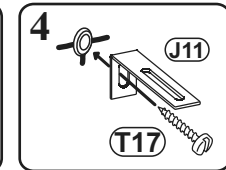
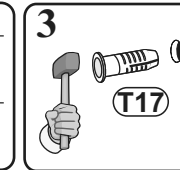
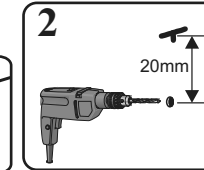
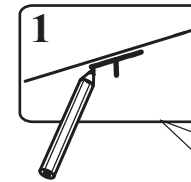
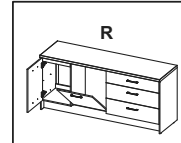
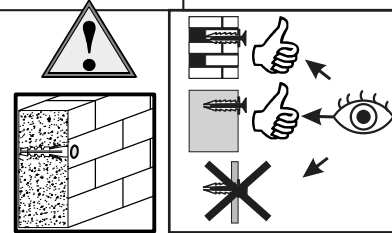
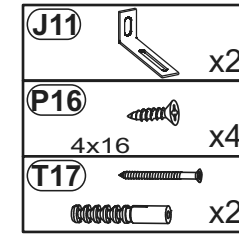
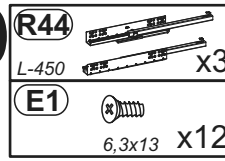

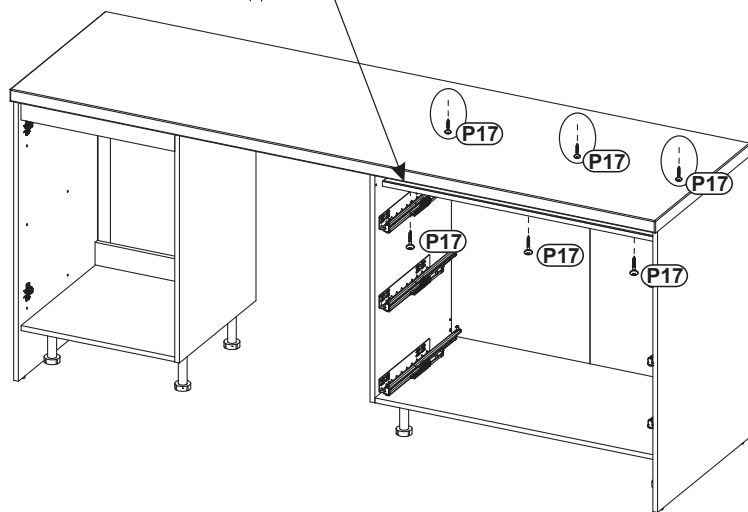
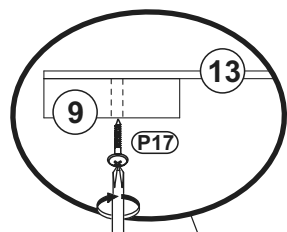
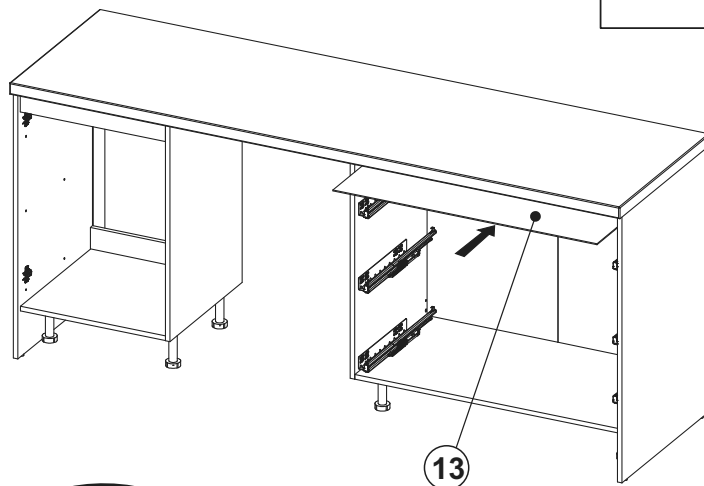
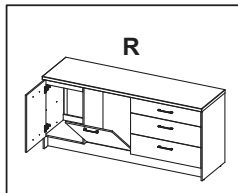
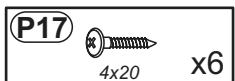

11

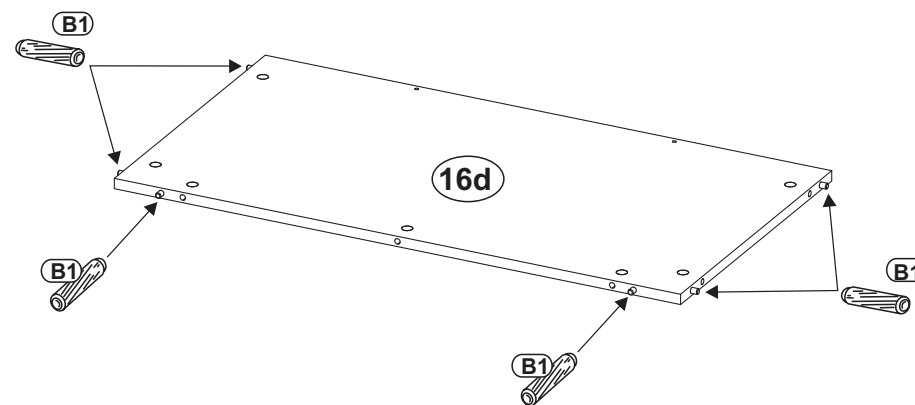
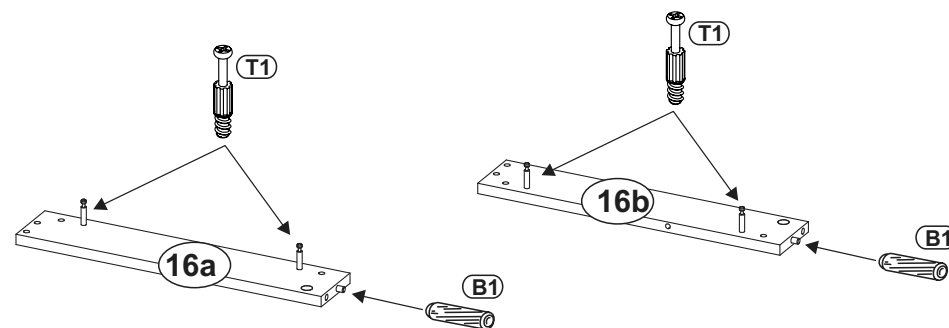
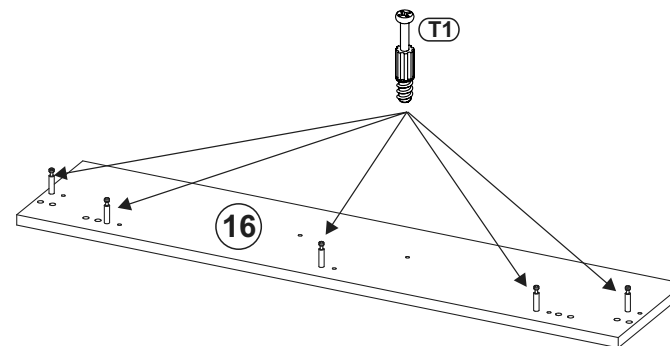
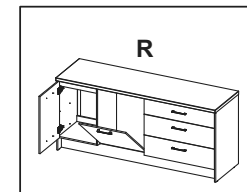
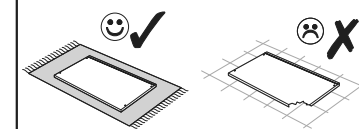
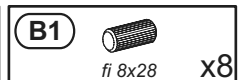
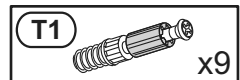

12



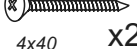

13

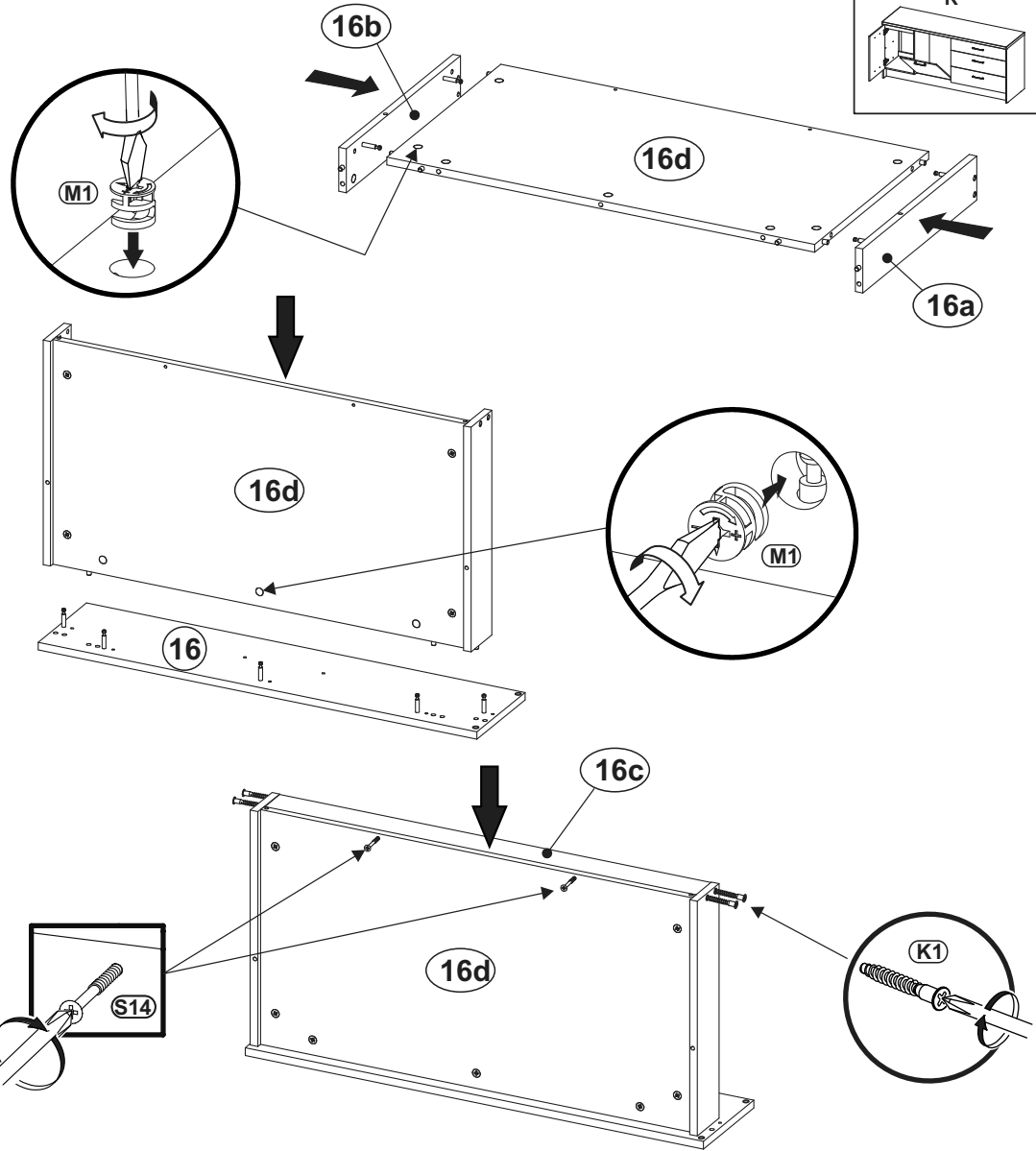
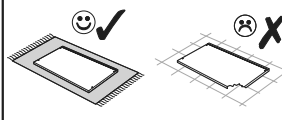
- M1**  x9
- K1**  7x50 x4
- S14**  4x40 x2

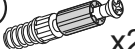

14

- T1**  x22
- B1**  fi 8x28 x16

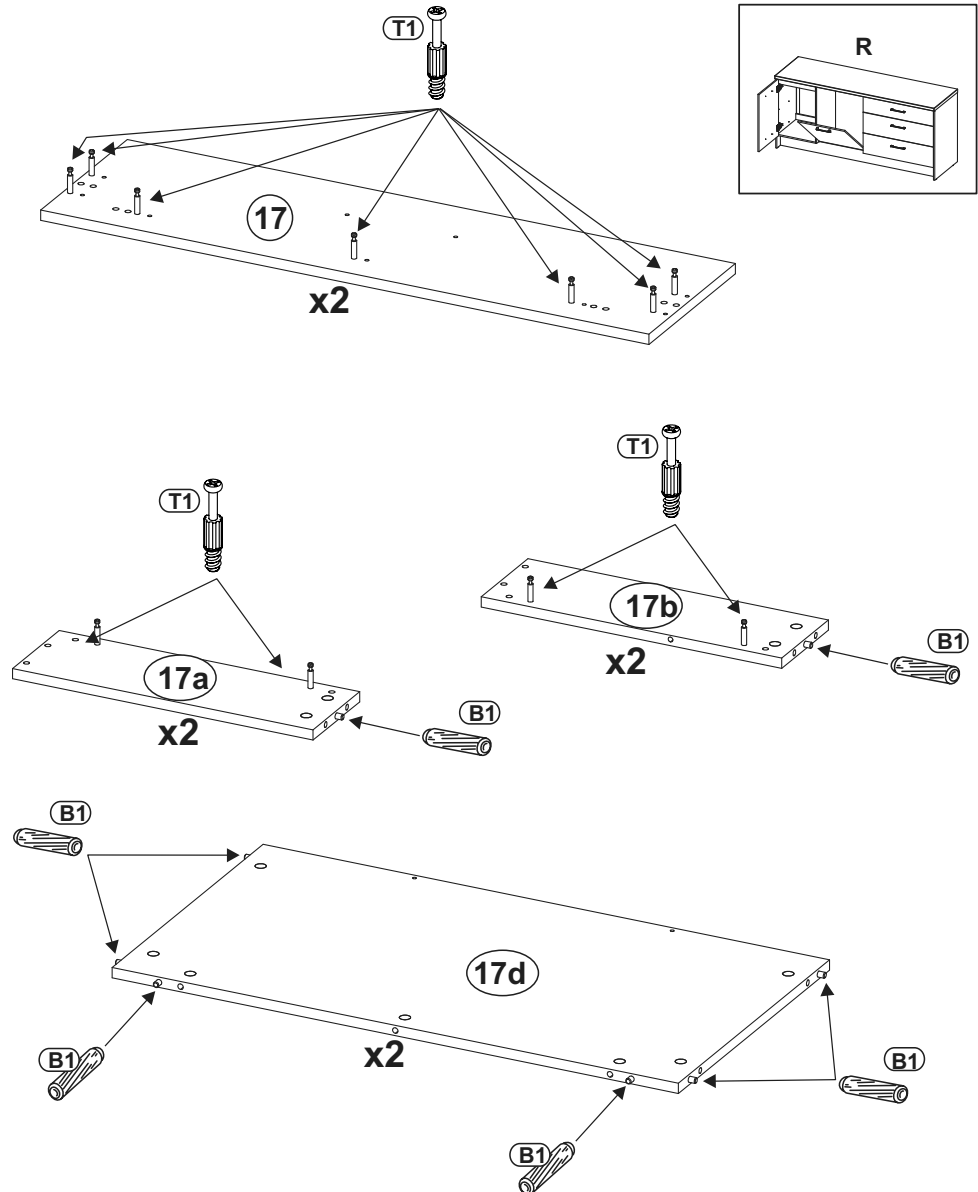
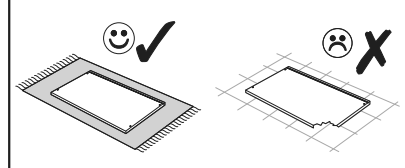

15

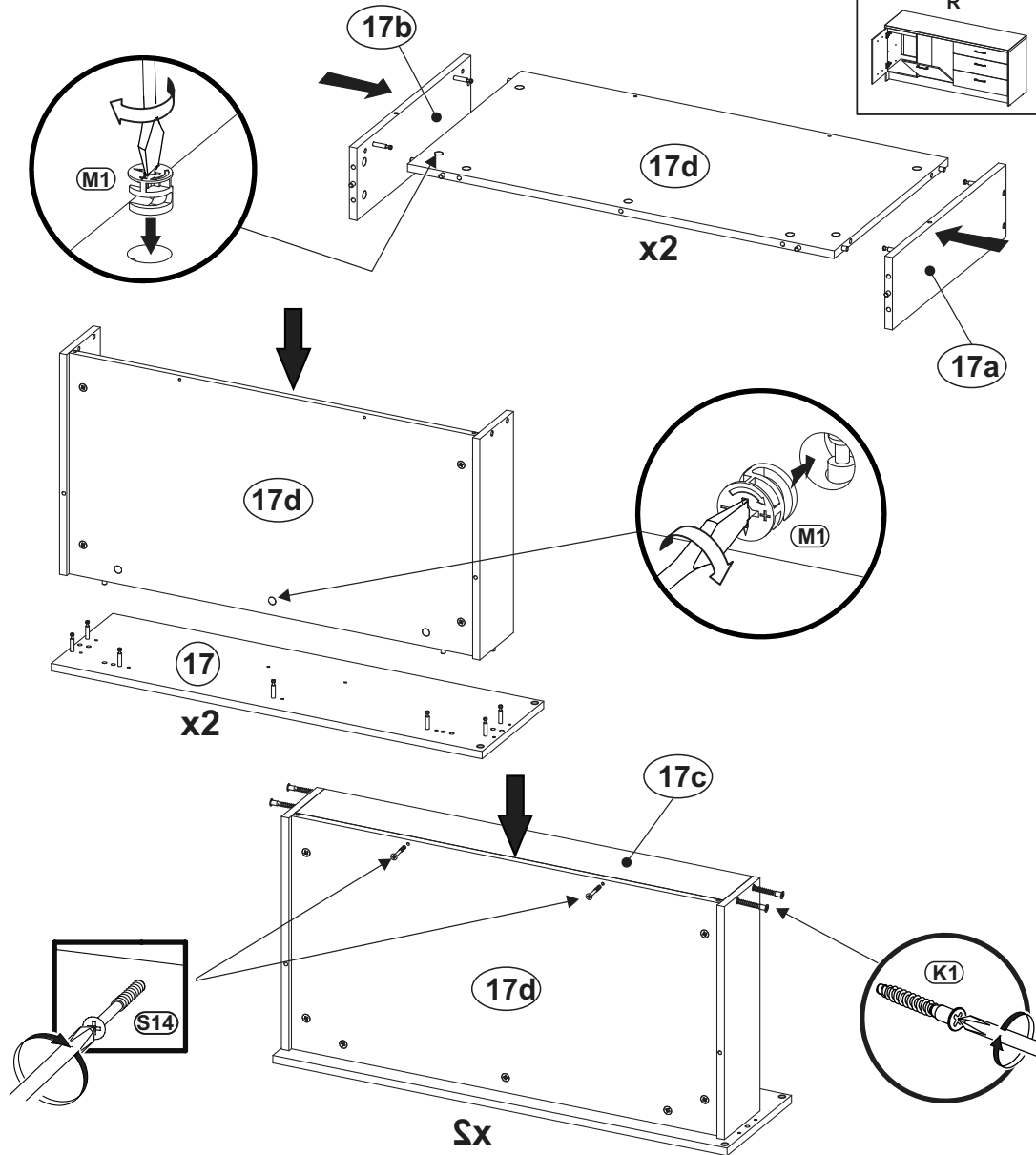
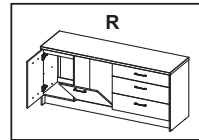
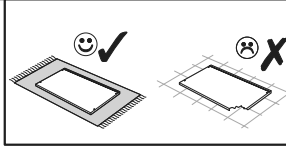
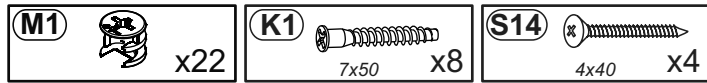

16

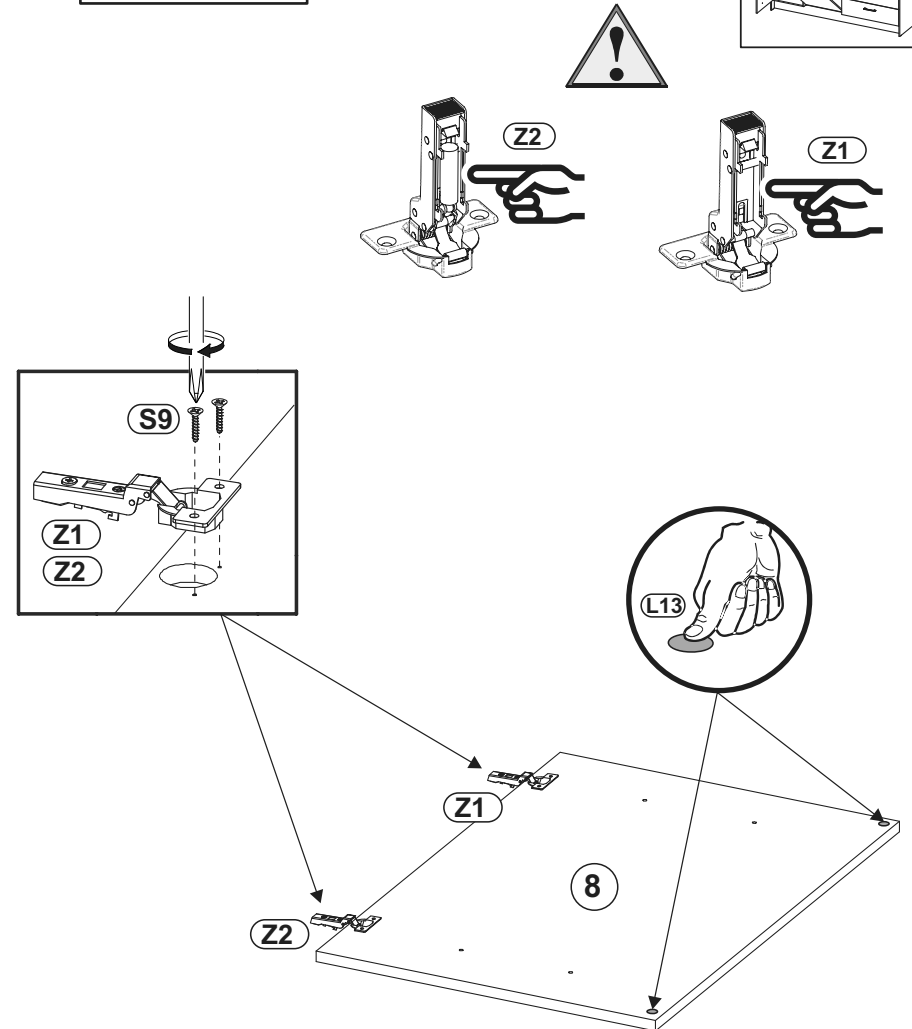
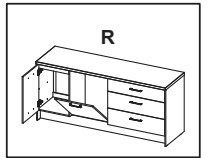
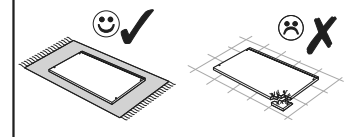
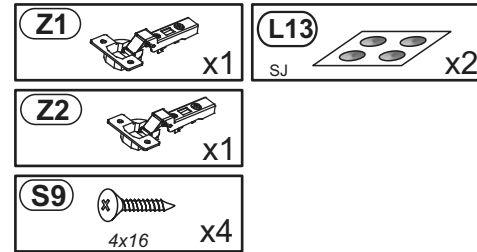

17

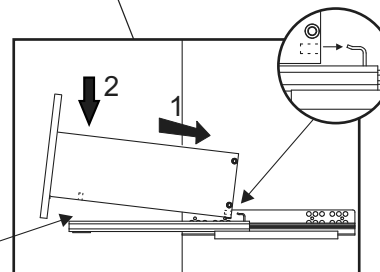
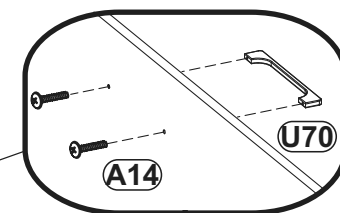
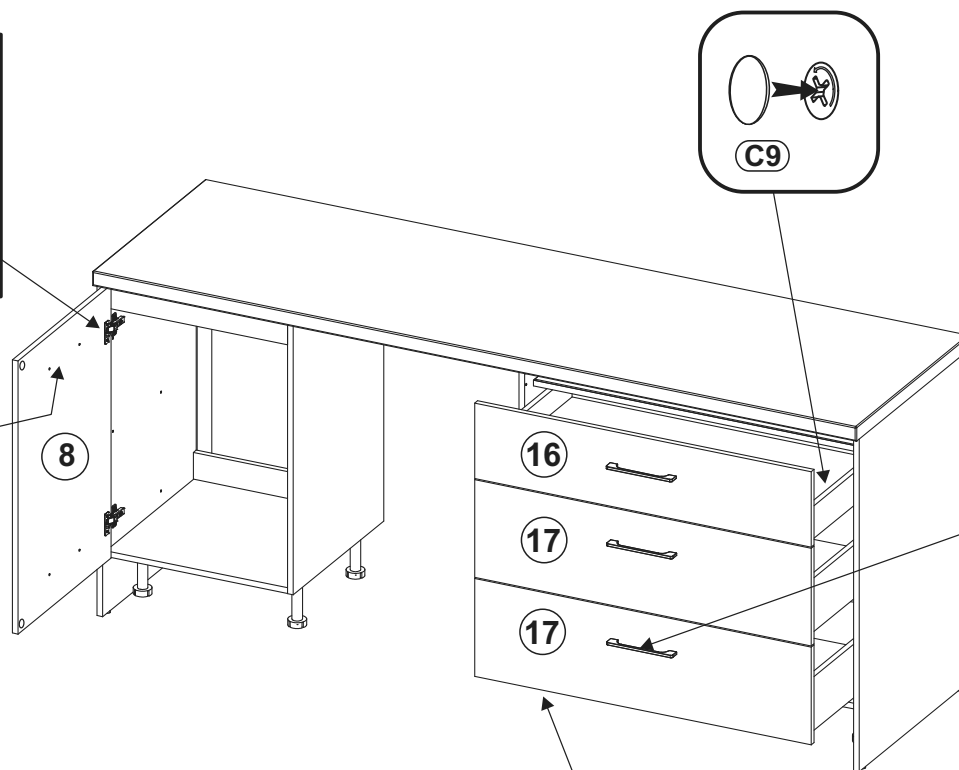
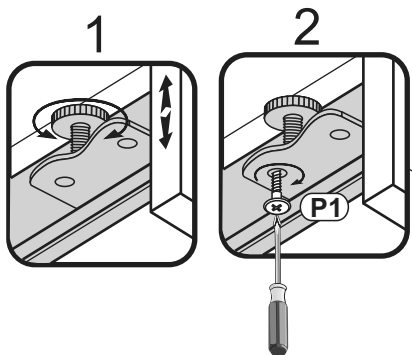
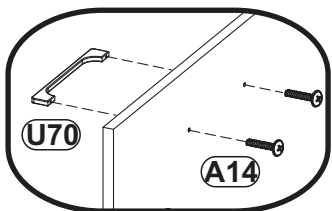
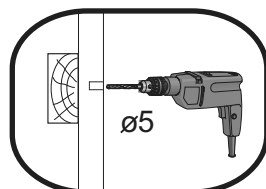
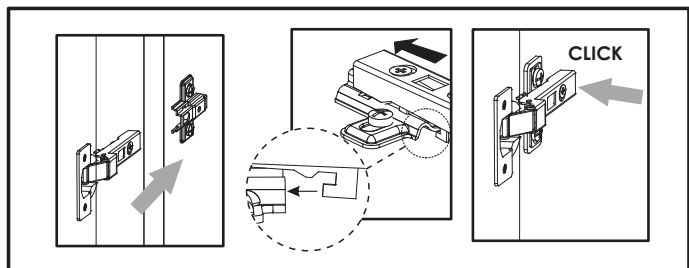
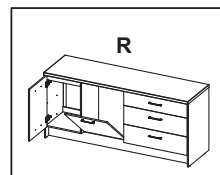
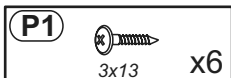
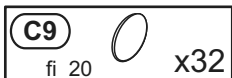
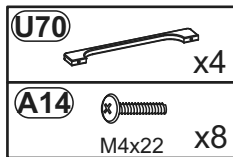

18

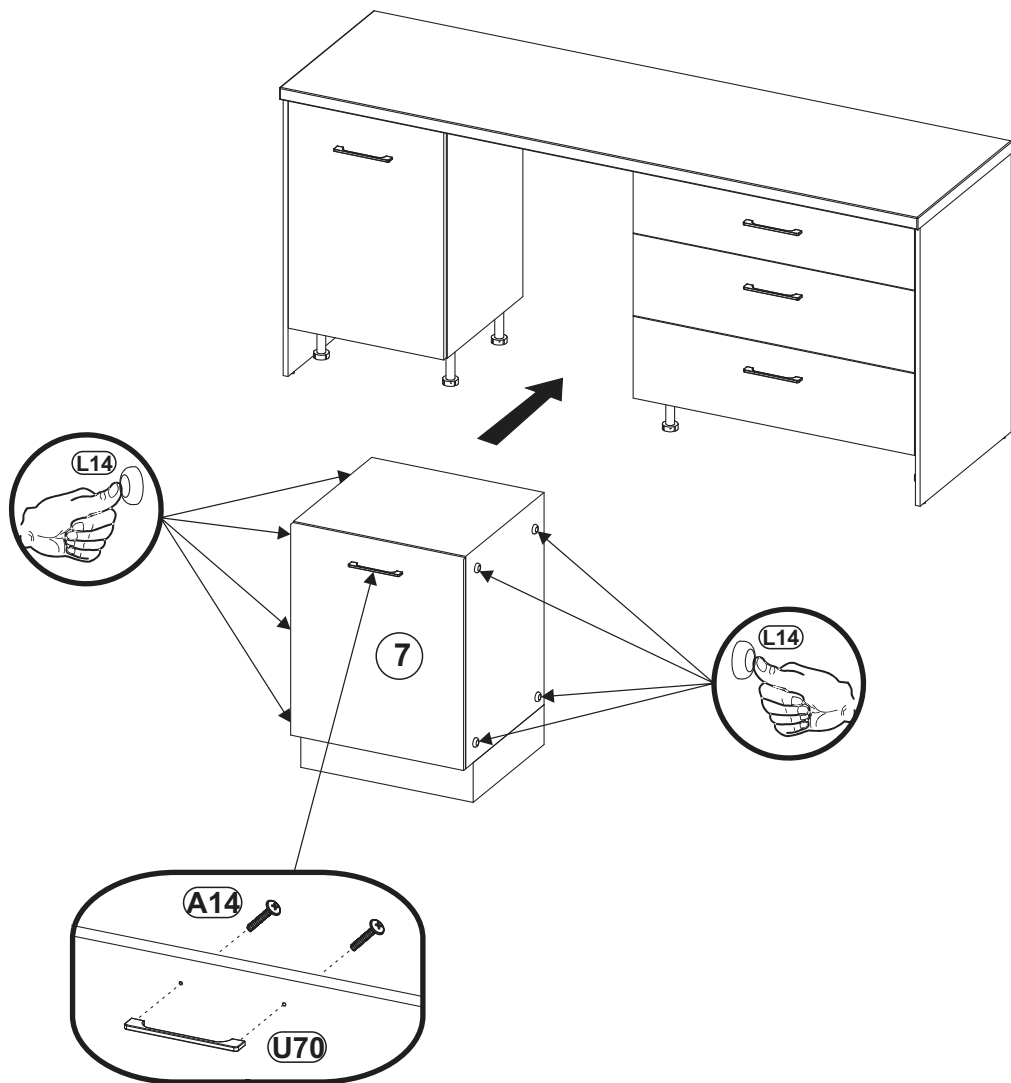
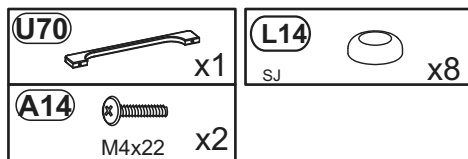

19

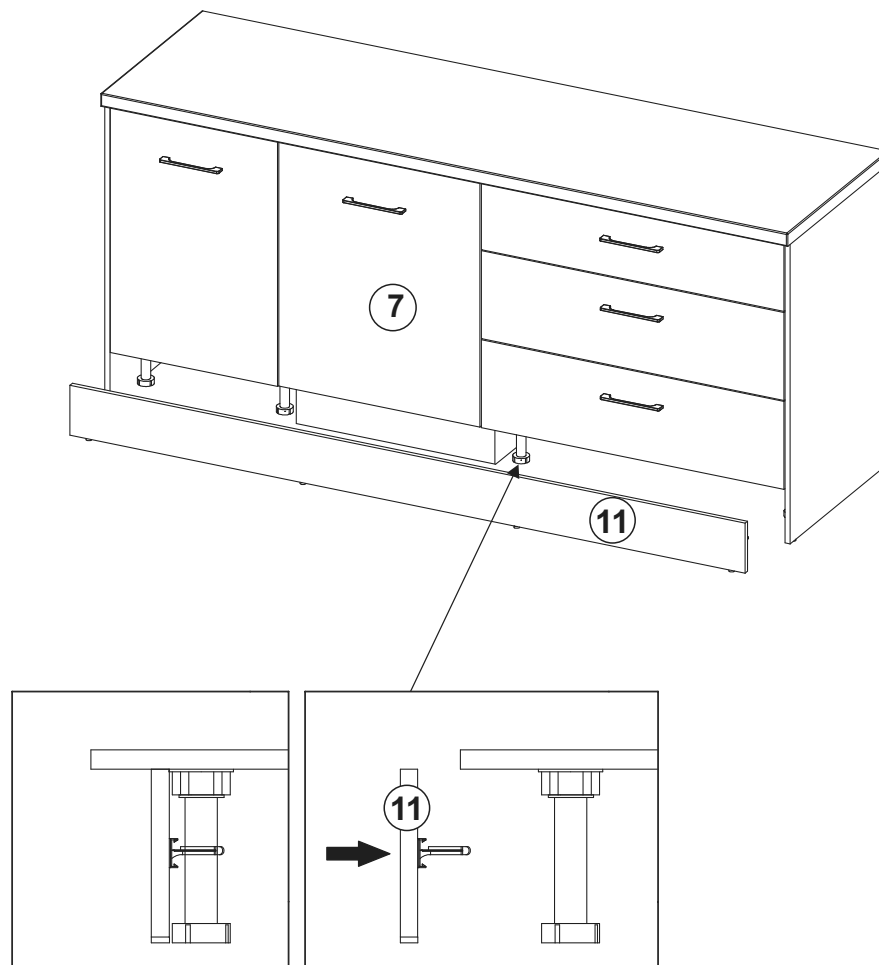
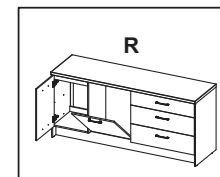

20

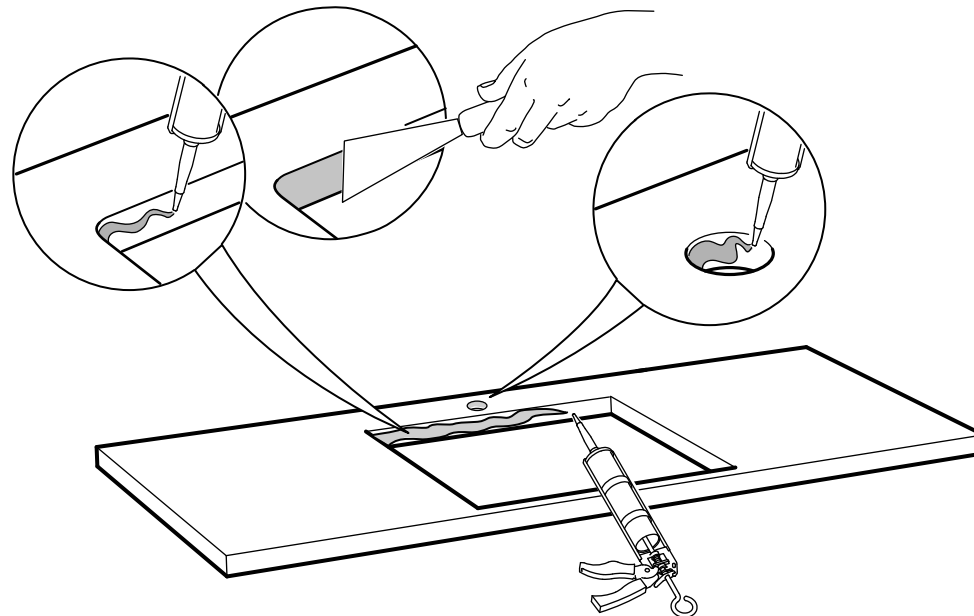
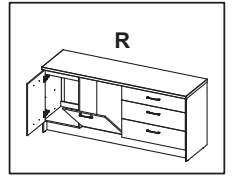
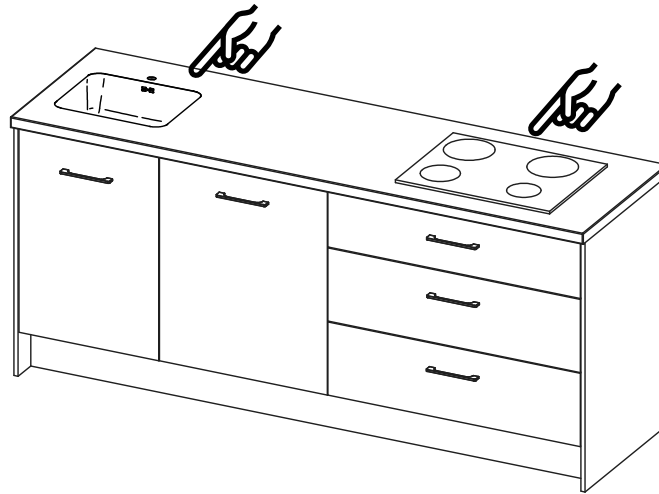

Service • Assistenza • Dienstverlening • Serwis Servis • Szerviz • Servizio • Usluga •

Name • Nom • Nome • Naam • Nazwa
Jméno • Názov • Név • Denumire
Nombre • Ime • Isim

MONTREAL

shop • geschäft • boutique • sklep • winkel •
negozio • bolt • tienda • obchod • dučan • mađaza • magazin

Nr. • No. • N° • říeříd • Ć • Sz • Ne



Typ • Type • Tip • Típus • Tipo

1K

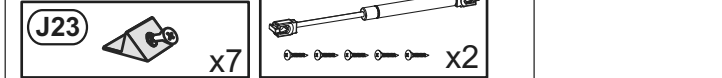
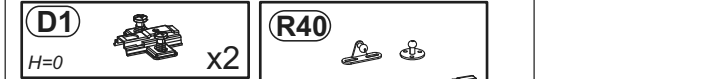
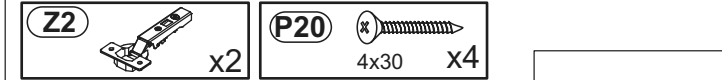
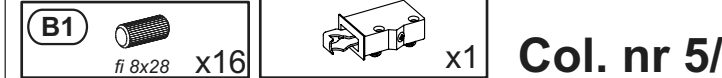
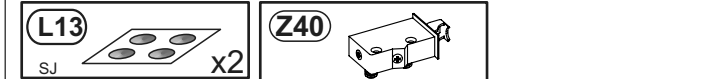
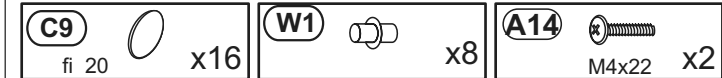
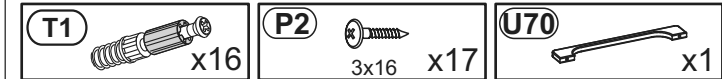
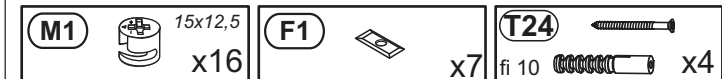
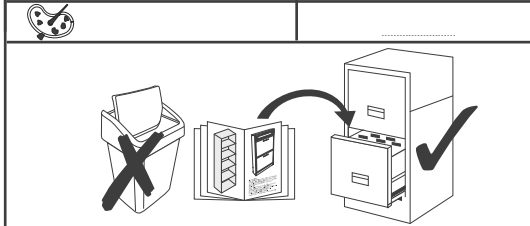

Col. nr 5/9

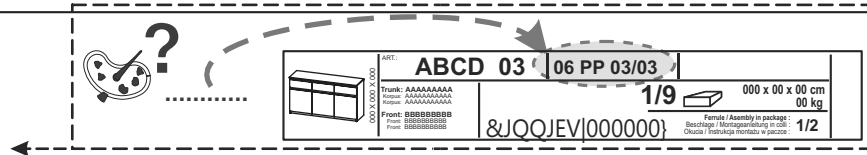

Col. nr 5/9

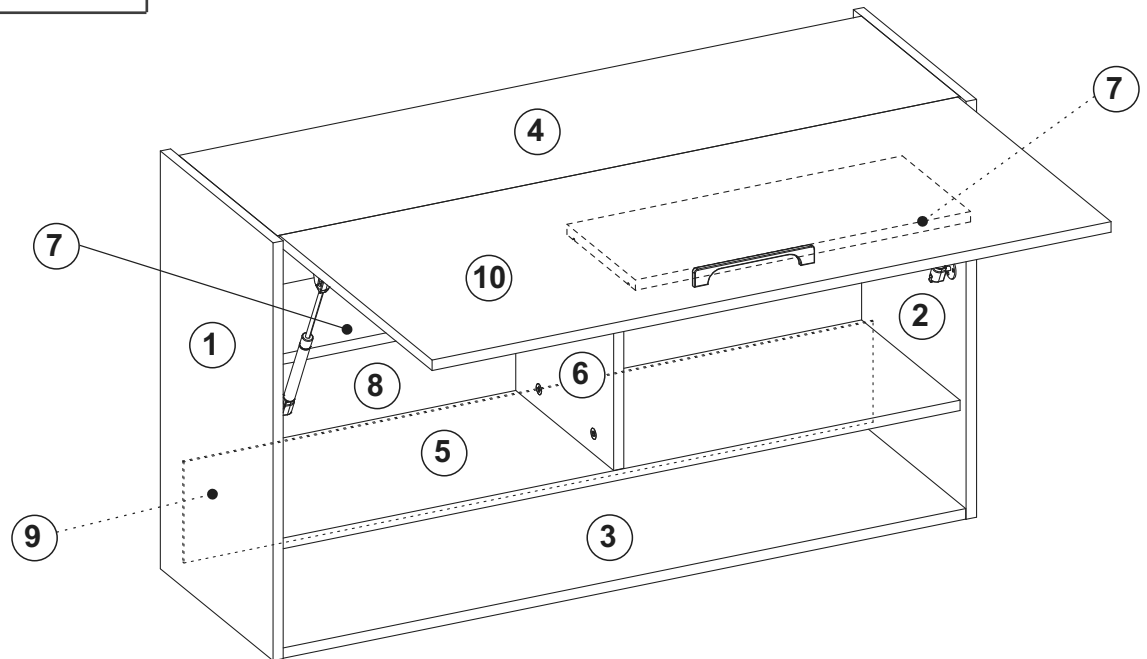

0 10 20 30 40 50 60 70 80 90 100 110 120 130 140 150 160 170 180 190 200



1

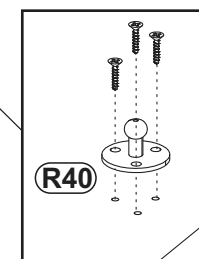
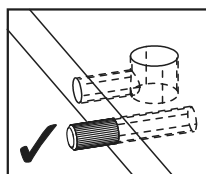
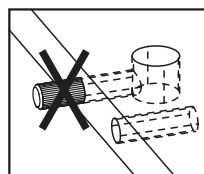
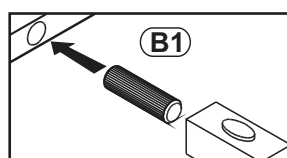
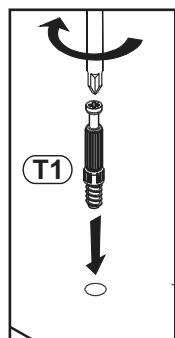
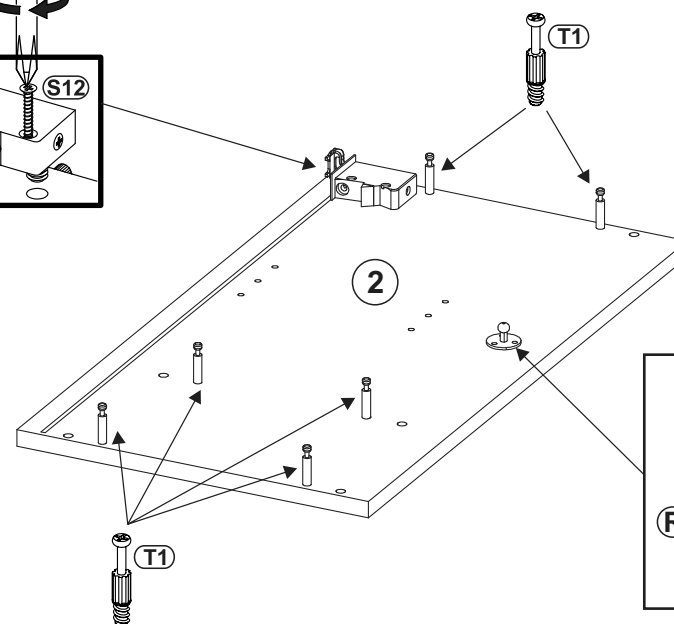
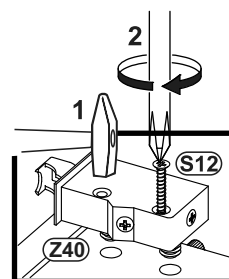
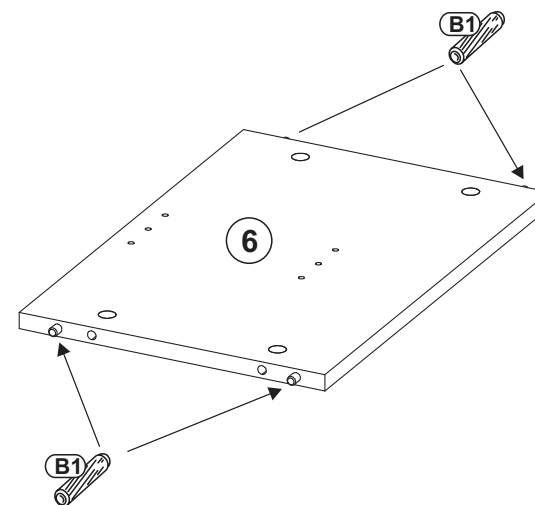
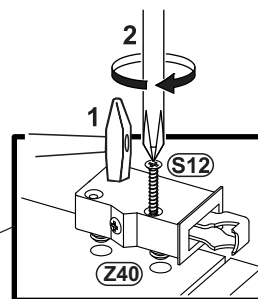
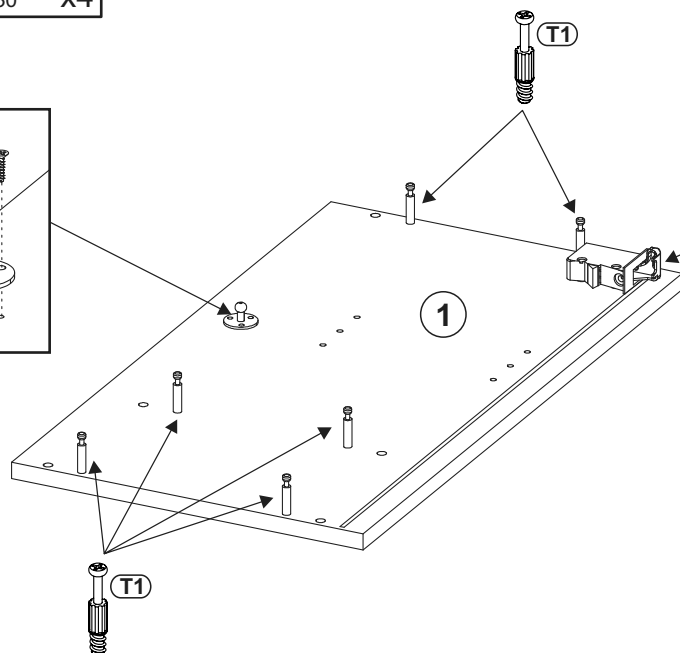
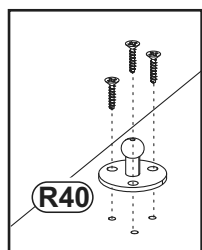
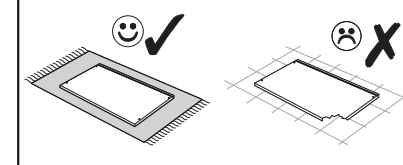
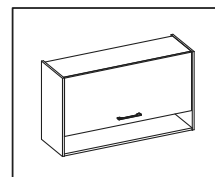
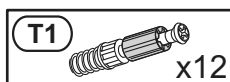
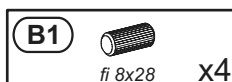
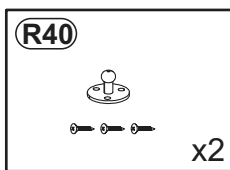
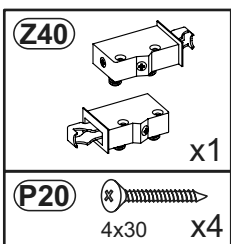

2

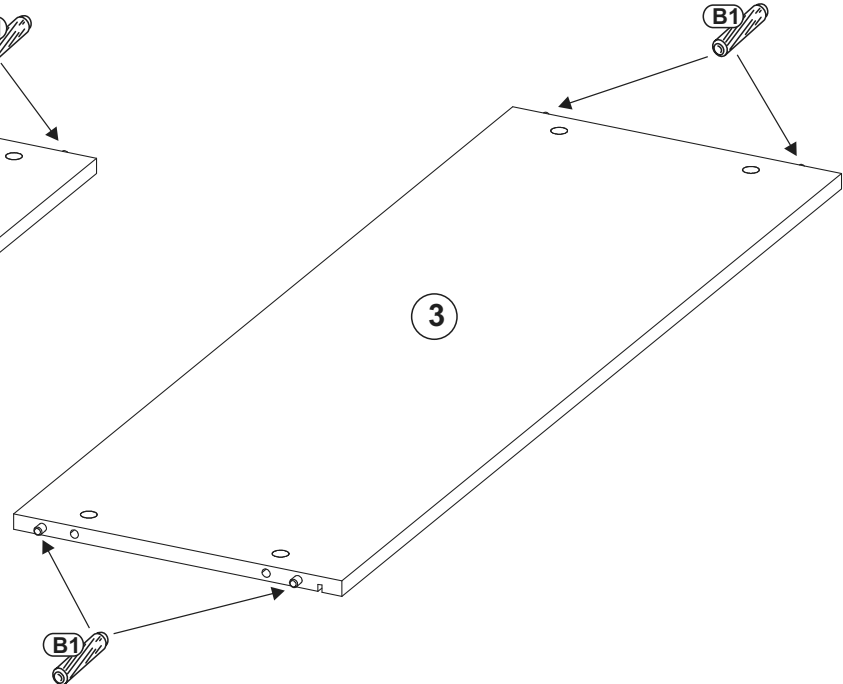
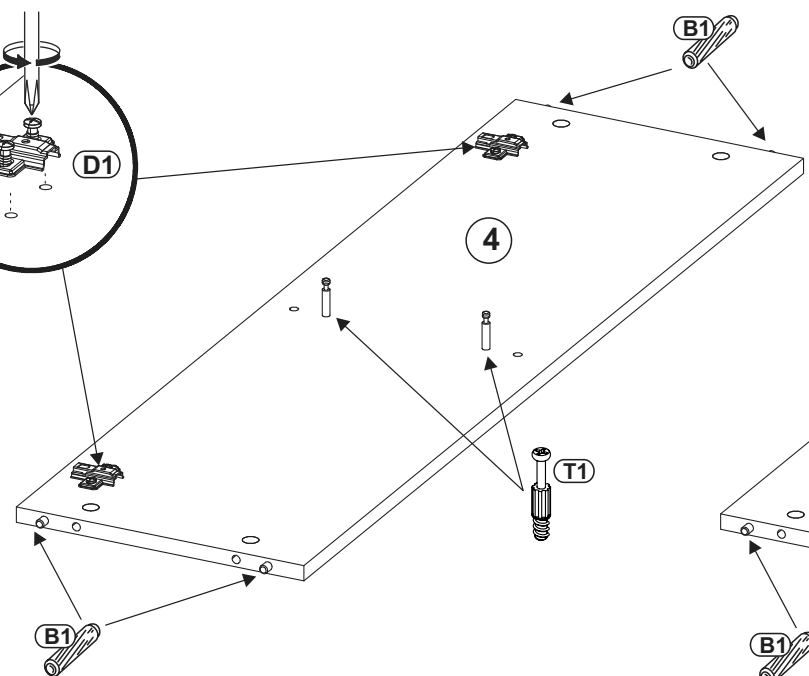
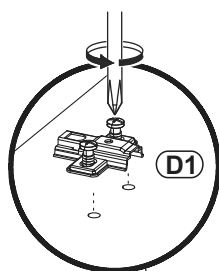
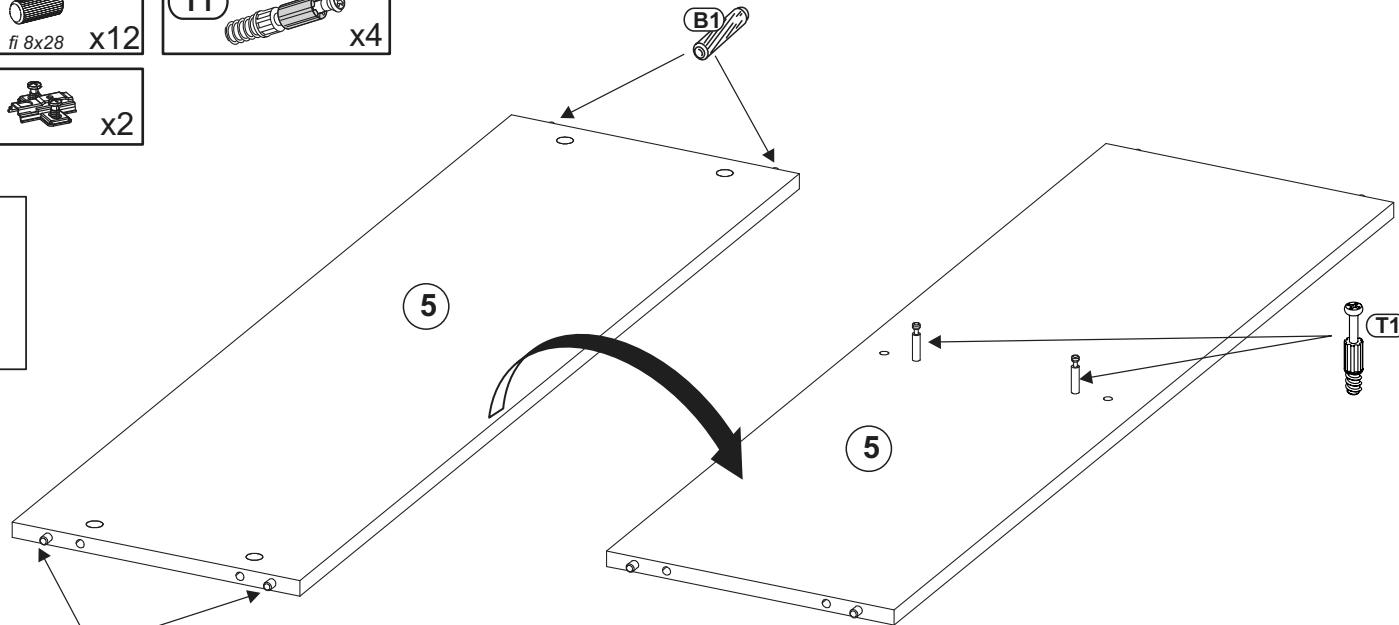
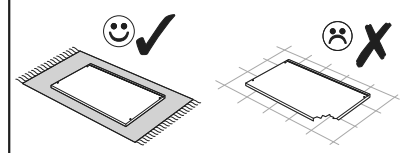
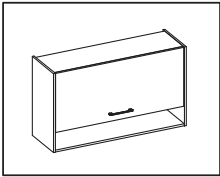
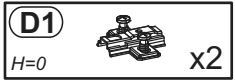
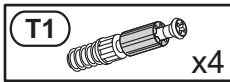
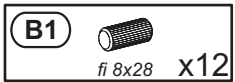

3

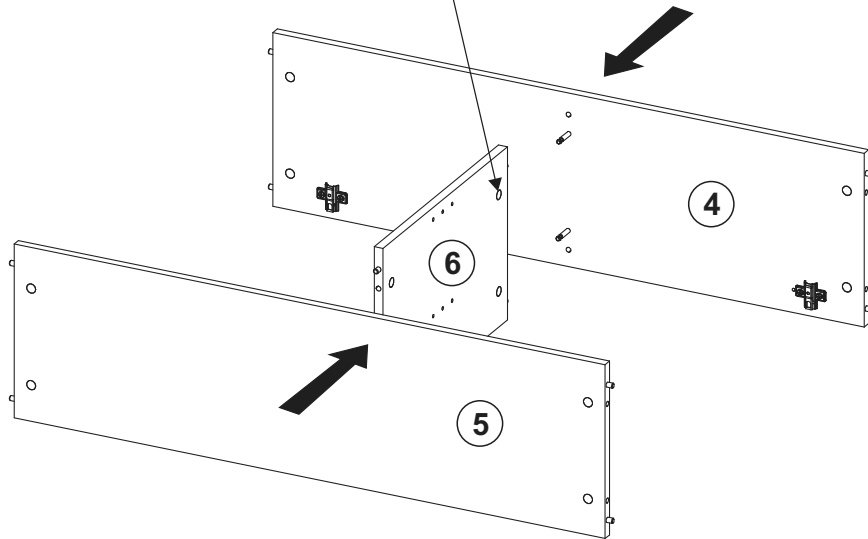
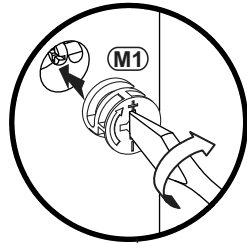
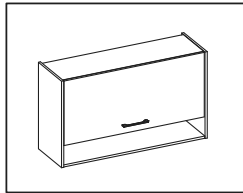
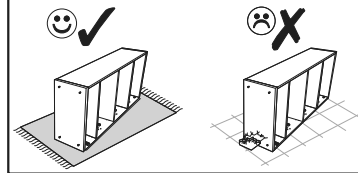

4

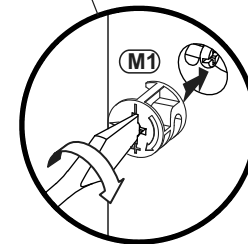
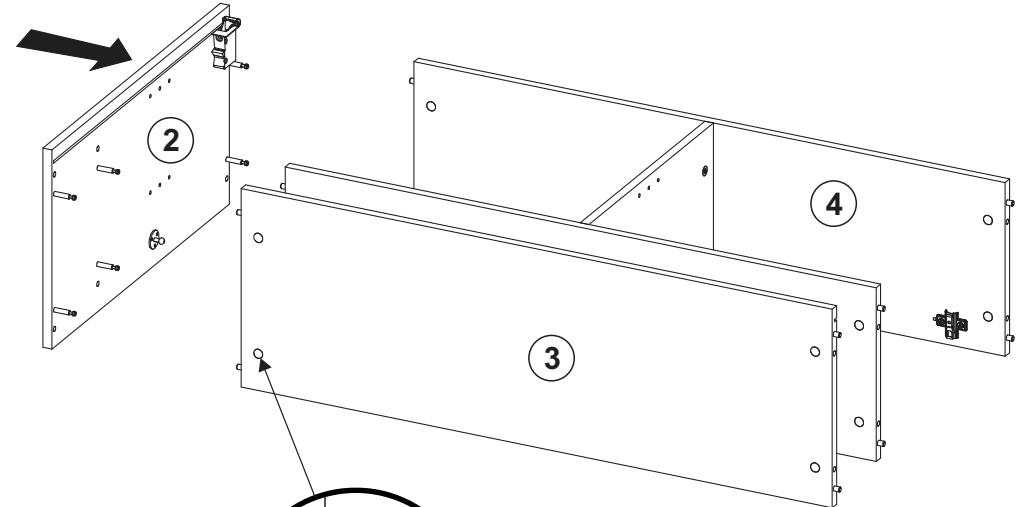
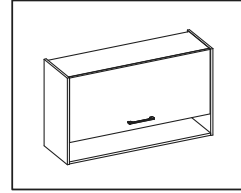
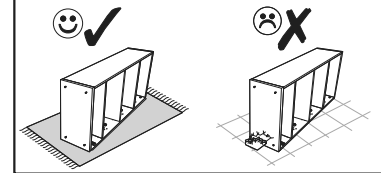

5

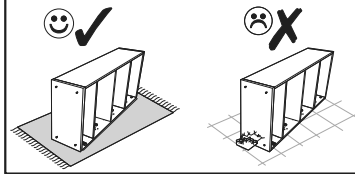
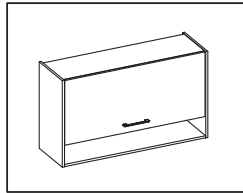

6

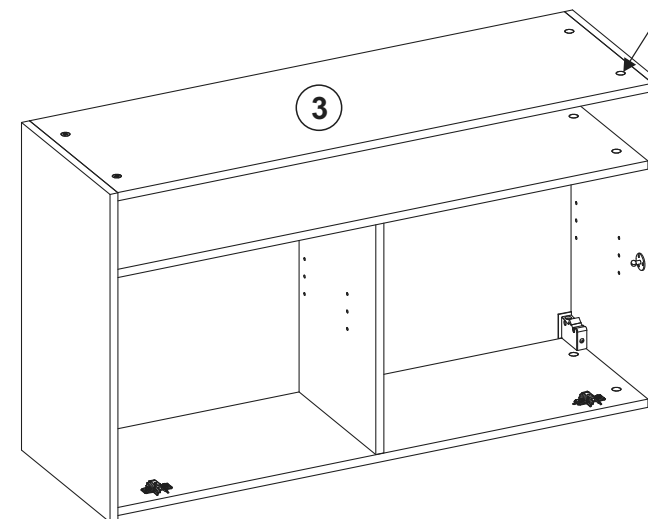
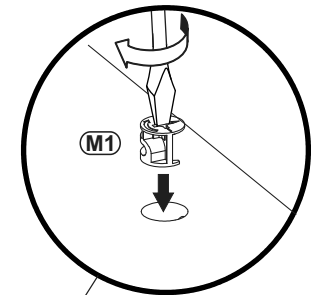
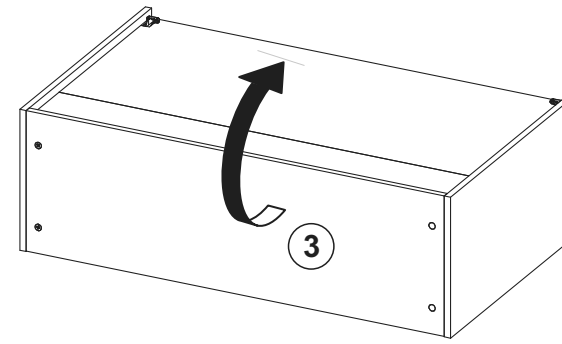
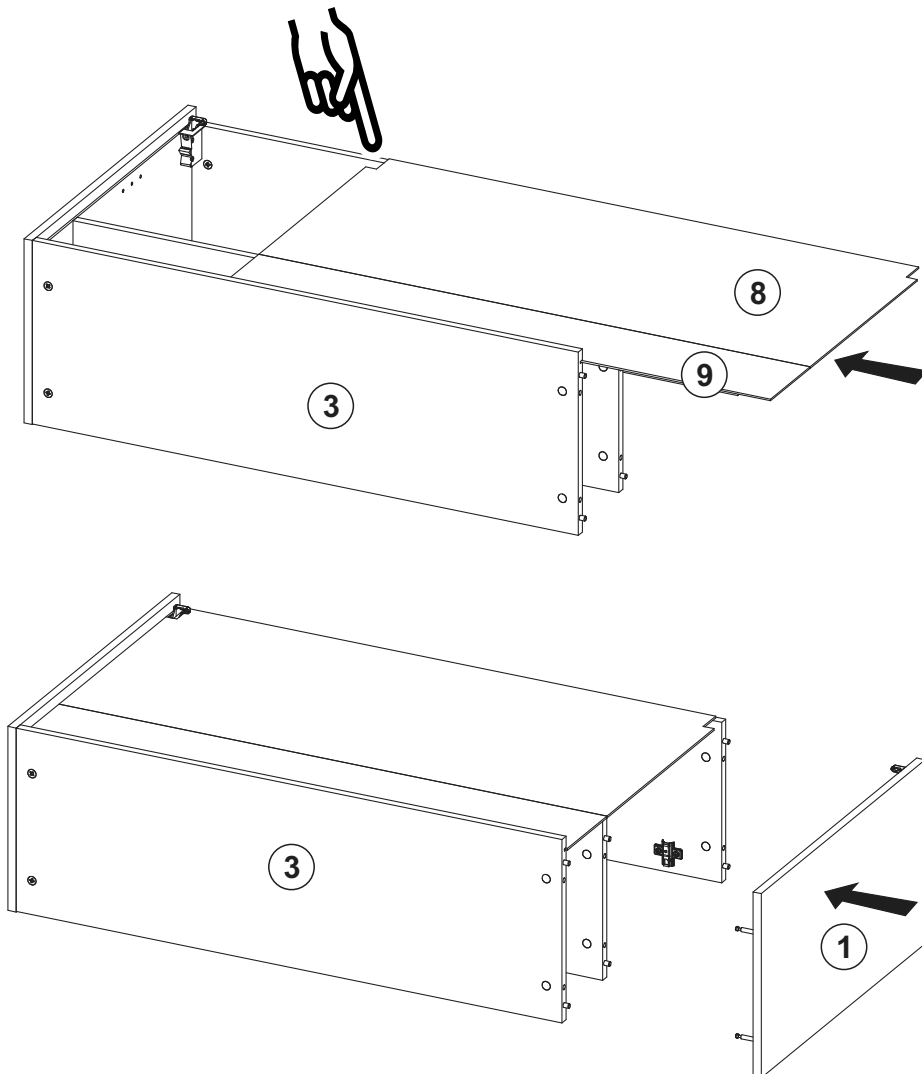
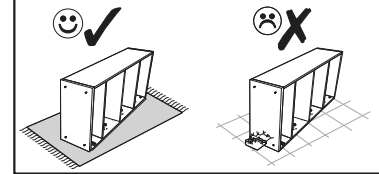
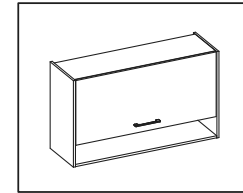

7

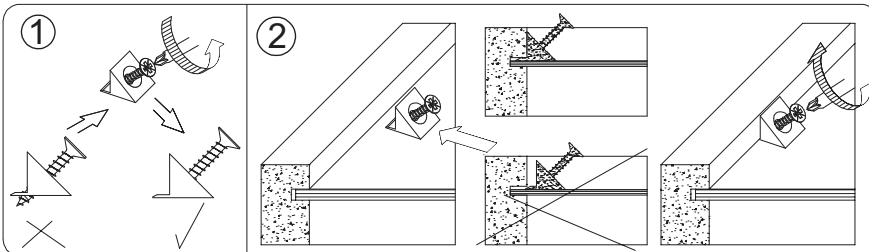
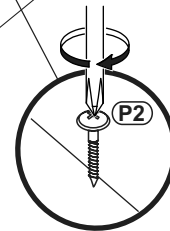
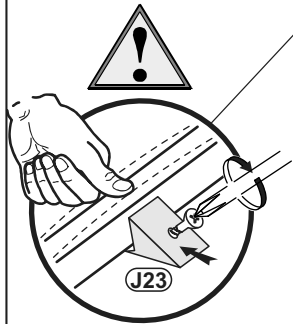
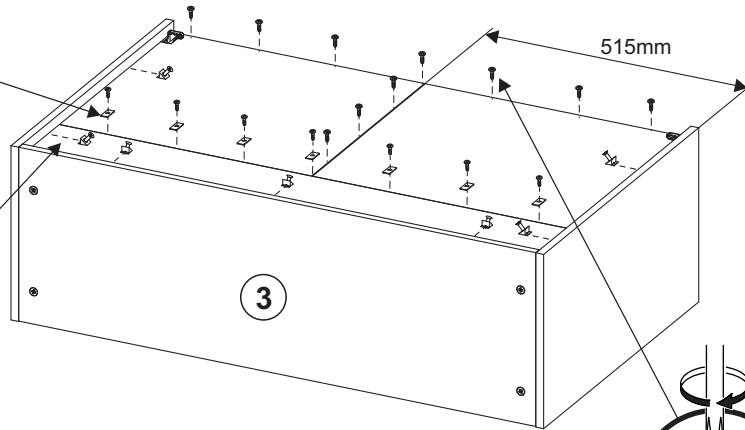
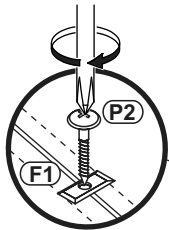
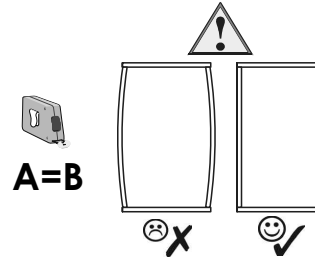
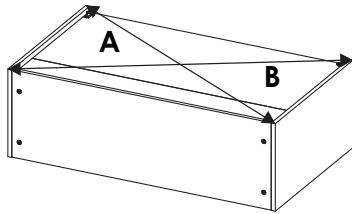
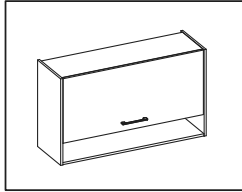
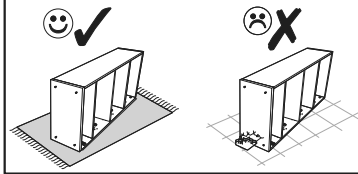
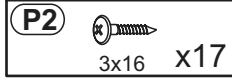
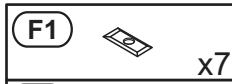

8

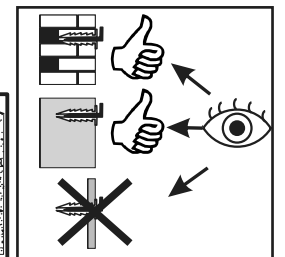
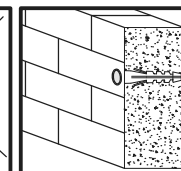
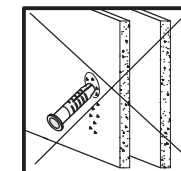
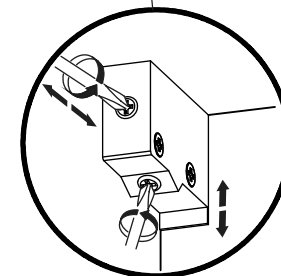
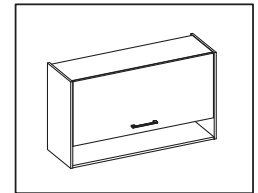
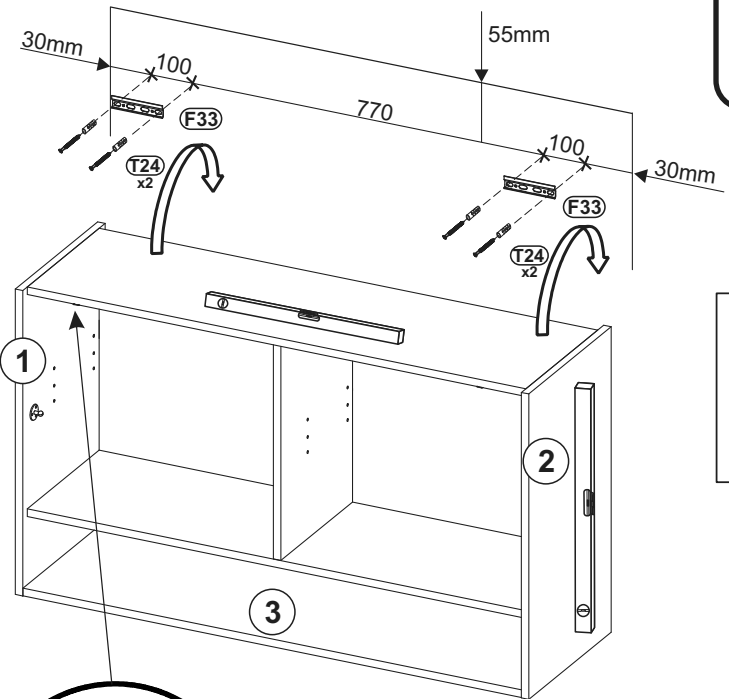
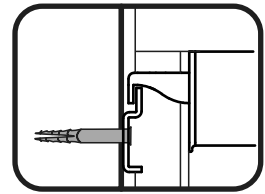
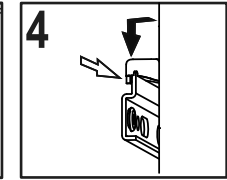
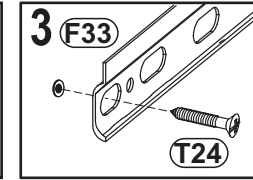
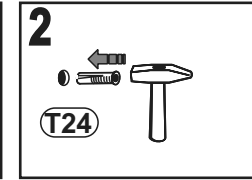
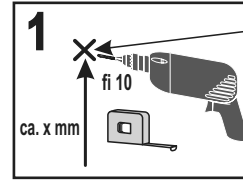
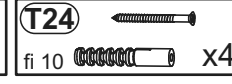
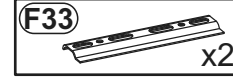

9

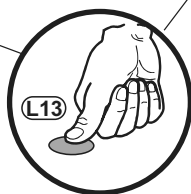
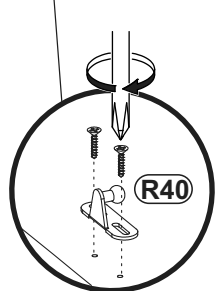
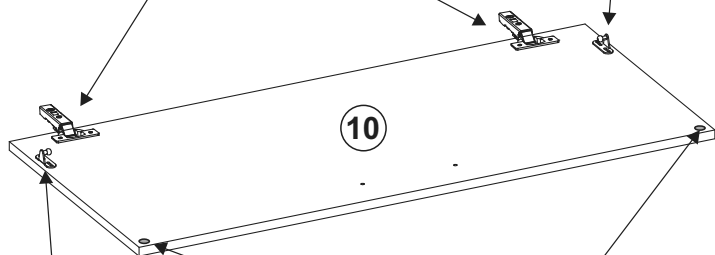
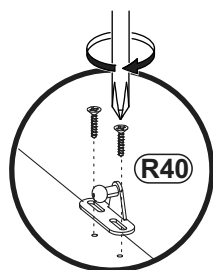
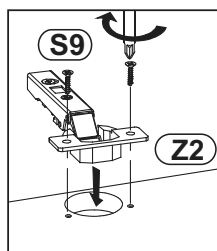
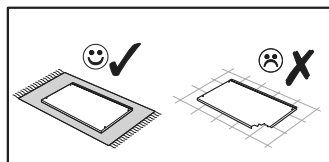
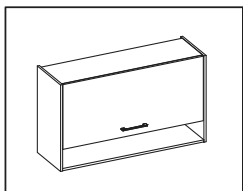
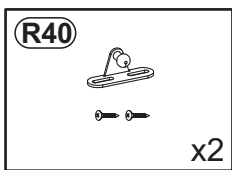
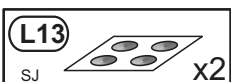
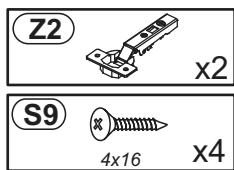

10

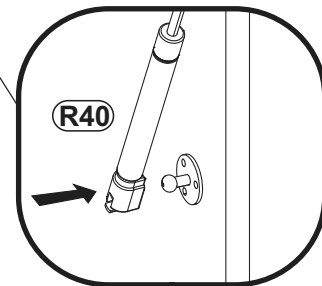
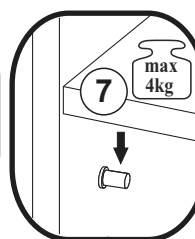
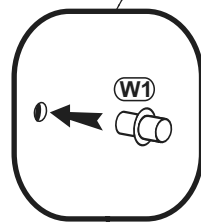
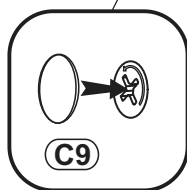
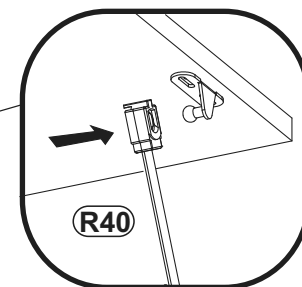
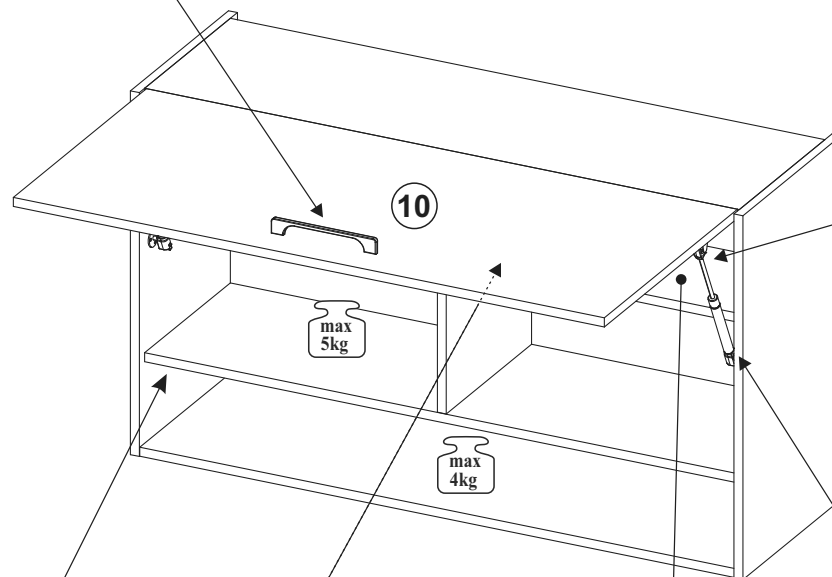
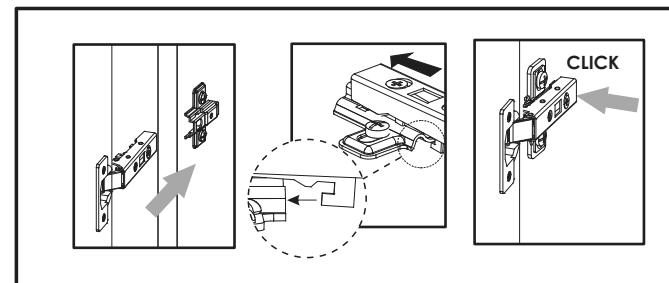
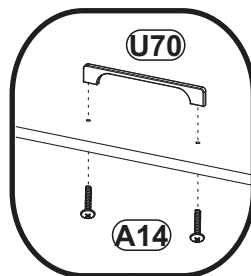
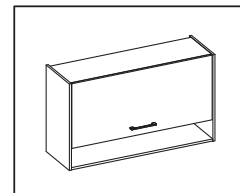
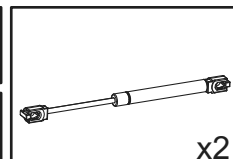
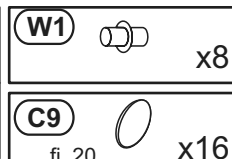
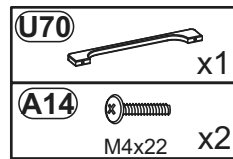

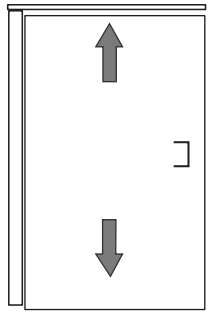

1

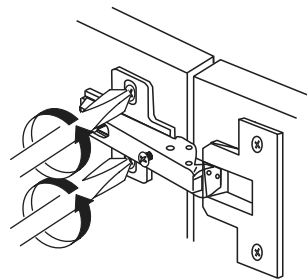

2

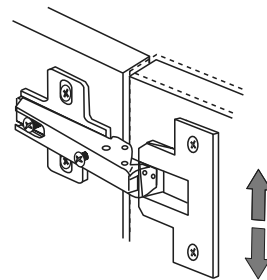

3

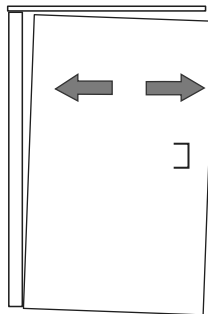
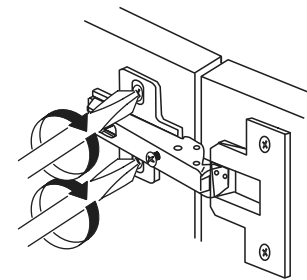

1

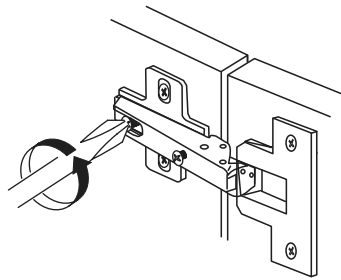

2

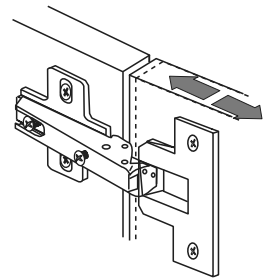

3

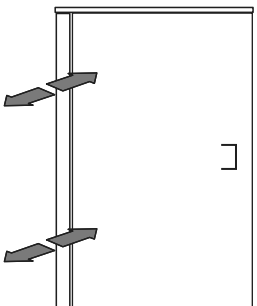
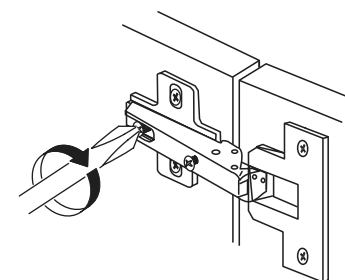

1

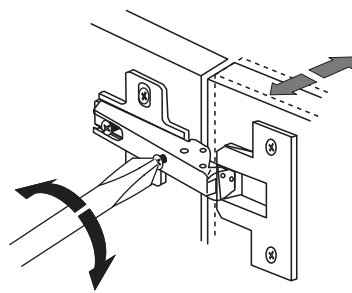

 <p>Important information Read carefully. Keep this information for further reference.</p> <p>(GB) WARNING</p> <p>Serious or fatal crushing injuries can occur from furniture tip-over. To prevent this furniture from tipping over it must be permanently fixed to the wall.</p> <p>Fixing devices for the wall are not included since different wall materials require different types of fixing devices. Use fixing devices suitable for the walls in your home. For advice on suitable fixing systems, contact your local specialized dealer.</p>	<p>Wichtige Information Sorgfältig lesen Diese Information aufbewahren</p> <p>(DE) ACHTUNG</p> <p>Wenn Möbelstücke umkippen, können ernste oder lebensgefährliche Verletzungen durch Einklemmen die Folge sein. Um zu verhindern, dass das Möbelstück umkippt, muss es fest an der Wand verankert werden.</p> <p>Beschläge für die Wandbefestigung sind nicht beige packt, da sie von der jeweiligen Wandbeschaffenheit abhängig sind. Befestigungsbeschläge benutzen, die für die heimischen Wände geeignet sind. Bei diesbezüglichen Fragen den örtlichen Fachhandel zu Rate ziehen.</p>	<p>Ważne informacje Przeczytaj uważnie. Zachowaj ulotkę na przyszłość.</p> <p>(PL) UWAGA</p> <p>Przewrócenie się mebli może doprowadzić do poważnych obrażeń lub śmierci. Aby zapobiec przewróceniu się mebla, należy na stałe przymocować go do ściany.</p> <p>W zestawie nie znajdują się żadne śruby mocujące ponieważ różne rodzaje ścian wymagają różnych typów śrub. Użyj śrub odpowiednich do ścian w Twoim domu. W przypadku wątpliwości, jakich śrub użyć, skontaktuj się z najbliższym specjalistycznym sklepem.</p>	<p>Důležitá informace Čtěte pečlivě. Ušchovejte pro pozdější použití.</p> <p>(CZ) VARO VÁNÍ</p> <p>Pokud se nábytek převrhne, může dojít k velmi vážným nebo dokonce fatálním poraněním. Abyste převržení nábytku zabránili, musíte ho natrvalo připevnit ke stěně.</p> <p>Upevňovací materiál není součástí balení, protože se liší v závislosti na materiálu stěny. Použijte tedy takový upevňovací materiál, který je vhodný na stěny u vás doma. Pokud se potřebujete poradit, obraťte se na místního odborníka.</p>	<p>Dôležité informácie! Čítajte pozorne. Informácie si uschovajte pre prípad potreby.</p> <p>(SK) UPOZORNENIE</p> <p>Prevrhnutie nábytku môže spôsobiť vážne či smrteľné zranenia. Aby sa predišlo prevrnutiu nábytku, upevnite ho ku stene.</p> <p>Upevňovací materiál nie je súčasťou balenia, pretože na každý materiál steny je potrebné použiť iný typ skrutky a hmoždinky. Použite upevňovací materiál vhodný na konkrétny typ materiálu, z ktorého je vaša stena vyrobená. V prípade potreby sa poraďte s odborníkom.</p>
<p>Informazioni importanti. Leggi attentamente. Conserva queste informazioni per ulteriori consultazioni.</p> <p>(IT) AVVERTENZA</p> <p>Se il mobile si ribalta può causare lesioni da compressione serie o fatali. Per prevenire il rischio che il mobile si ribalti, quest'ultimo deve essere fissato permanentemente alla parete.</p> <p>Gli accessori per il fissaggio alla parete non sono inclusi perché pareti di materiali diversi richiedono tipi diversi di accessori di fissaggio. Usa sistemi di fissaggio adatti alle pareti della tua casa. Per maggiori dettagli, rivolgiti a un rivenditore specializzato.</p>	<p>Belangrijke informatie Goed lezen Bewaar deze informatie voor toekomstig gebruik</p> <p>(NL) WAARSCHUWING</p> <p>Wanneer meubels omvallen, kan er ernstig of levensbedreigend beklemmingsletsel ontstaan. Om te voorkomen dat dit meubel omvalt, dient dit permanent aan de wand te worden bevestigd.</p> <p>Bevestigingsbeslag voor de wand is niet inbegrepen, aangezien verschillende wandmaterialen verschillende soorten bevestigingsbeslag vereisen. Gebruik bevestigingsbeslag dat geschikt is voor de wanden in je huis. Voor advies over geschikt bevestigingsbeslag, neem contact op met de vakhandel.</p>	<p>Information importante A lire attentivement. Conserver ces informations pour un usage ultérieur.</p> <p>(FR) AVERTISSEMENT</p> <p>Risque de blessure grave en cas de chute du meuble. Pour éviter que le meuble ne bascule, il faut le fixer au mur de façon permanente.</p> <p>Les fixations ne sont pas incluses car leur choix dépend du matériau du mur sur lequel est fixé le meuble. Utilisez des fixations adaptées au matériau du mur. Pour obtenir des conseils sur les fixations à utiliser, adressez-vous à un revendeur spécialisé.</p>	<p>Informații importante Citește cu atenție. Păstrează aceste informații pentru referințe ulterioare.</p> <p>(RO) ATENȚIE</p> <p>Pot surveni răni grave dacă te împiedici de obiectele de mobilier. Pentru prevenirea rănilor, fixează mobila pe perete.</p> <p>Accesoriiile de fixare pentru perete nu sunt incluse deoarece materialele diferite din care sunt făcuți pereții au nevoie de accesorii diferite de fixare. Folosește accesoriiile de fixare potrivite pentru pereții camerei tale. Contactează un specialist dacă nu știi care sunt accesoriiile potrivite pereților casei tale.</p>	<p>Önemli bilgi Dikkatli okuyunuz. Bu kılavuzu ileride gerekebileceği için saklayınız.</p> <p>(TR) UYARI</p> <p>Mobilyanın devrilmesi sonucu ölümcül veya ciddi yaralanmalar meydana gelebilir. Devrilme riskini önlemek için mobilyanın duvara sabitlenmesi gerekmektedir.</p> <p>Duvar yapı malzemesi farklılık gösterebileceğinden ,mobilyanın duvara sabitlenmesi için gereken bağlantı parçaları ürüne dahil değildir. Evinizin duvar yapı malzemesine uygun bağlantı parçaları seçiniz. Duvar yapı malzemesine uygun bağlantı parçaları satın almak için en yakın yapı market ya da bir nalbur dükkânından bilgi alabilirsiniz.</p>
<p>Važne informacije Pažljivo pročítajte. Sačuvajte ove upute za buduće potrebe.</p> <p>(HR) UPOZORENJE</p> <p>Ako se namještaj prevrne može doći do ozbiljnih ili smrtonosnih ozljeda. Kako bi izbjegli prevrtanje, namještaj mora biti pričvršćen na zid.</p> <p>Pričvrscnici za zid nisu priloženi s obzirom da različite vrste zida zahtijevaju uporabu različitih vrsta pričvrscnika. Upotrijebite pričvrscnike prikladne za zidove vašeg doma. Za savjet o prikladnim vrstama pričvrscnika kontaktirajte lokalnu specijaliziranu trgovinu.</p>	<p>Bitno! Pažljivo pročítajte! Sačuvajte za ubuduće.</p> <p>(SRB) UPOZORENJE</p> <p>Mogu nastati ozbiljne povrede usled prevrtanja namještaja. Da ovaj namještaj ne bi pao, mora stalno biti pričvršćen za zid.</p> <p>Nisu dati okovi, tiplovi i šrafovi za pričvršćivanje jer se zidovi razlikuju i različiti materijali zahtijevaju i različite okove. Upotrebite one koji su pogodni za zidove u vašem domu. Za savet koje okove da upotrebite, obratite se u lokalnoj govodžari.</p>	<p>Fontos informacio Kerjűk, olvasd el alaposan, es orizd meg ezt a papirt!</p> <p>(HU) FIGYELEM</p> <p>A butor felborulasa sulyos, vagy akar vegzetes balesetet okozhat. Ahhoz, hogy ezt megakadalyozd, a butort megfeleloen a falhoz kell rogzíteni.</p> <p>A rogziteshez szukseges kellekek nincsenek a csomagban, mivel a kulonbozo tipusu falakhoz kulonbozo rogzito eszkozokre van szuksege. Mindig a fal tipusanak megfelelo szerelvenyeket hasznalj! A megfelelo rogzitok kivalasztasahoz fordulj segitseget a szakuzletek munkatarsaihoz!</p>	<p>Important! Ler estas instruções cuidadosamente. Guardar como referencia.</p> <p>(PT) IMPORTANTE</p> <p>As quedas de móveis podem originar esmagamento ou morte. Estes móveis devem ser fixados a parede para evitar possíveis quedas.</p> <p>Os diferentes tipos de parede requerem diferentes tipos de ferragens. Utilize ferragens adequadas as paredes da sua casa (nao incluídas). Se nao tiver a certeza do tipo de parafusos ou ferragem a usar, consulte uma loja de ferragens.</p>	<p>ВажливаТінформація ПрочітайтеТүважно ЗберітьТцюТінструкцію</p> <p>(UA) УВАГА</p> <p>ПадінняКнезакріпленихКмеблівКможеКспричинитиКсерйознеКкабКсмертельнеКтравмування людини.КЩобКзапобігтиКперекиданнюКцихКмеблів,КіхКслідКміцноКприкріпитиКдоКстіни.</p> <p>КріпленняТдоТстіниТнеТдодаються,ТоскількиТрізніТматеріалиТпотребуютьТрізнихТкріплень. ВикористовуйтеТкріпильніТпристрої,ТякіТпасуютьТматеріалуТвашоТстіни.ТзаТпорадоюТщодо належнихТсистемТкріпленняТзвертайтесяТу місцевуТспеціалізовануТкрамницю.</p>
<p>ВажнаяТінформация ВнимательноТпрочитайте. СохранитеТэтуТінформацию.</p> <p>(RU) ВНИМАНИЕ</p> <p>ОпрокидываниеКмебелиКможетКпривестиКк серьезнымКилиКсмертельнымКтелеснымКповреждениям.КдляКпредотвращенияКпрокидыванияКмебелиКдолжнаКбытьКпостоянноКприкрепленаКкКстене.</p> <p>КрепёжныеТсредстваТдляТкрепленияТкТстенеТнеТприлагаются,ТдляТразныхТматериаловТстенТтребуютсяТразличныеТкрепления.Тиспользуйте крепёжныеТсредства,ТподходящиеТдляТматериала стеныТвТвашемТдоме.ТеслиТвыТнеТуверены,Ткакой типТкрепленияТподходитТкТданномуТматериалу, обратитесьТвТспециализированныйТмагазин.</p>	<p>ВажнаТінформация ПрочететеТвнимательно ЗапазетеТтазиТінформацияТзаТваТдешаТсправка.</p> <p>(BY) ВНИМАНИЕ</p> <p>ПрекаутрванетоКнаКтазиКмебелКможеКда причиниКсерйозниКилиКфаталниКнаранявания. ЗаКдаКвизбегнетеКтазиКопасност,Кзакрепете здравоКзаКстената.</p> <p>КомплектыТнеТвключаютТмеханизмыТзаТприкрепяне кТстената,ТтыТктоТразличнитеТстенини материалыТиспискватТразличниТприспособления. ИспользуйтеТмеханизмыТзаТприкрепяне, подходящиТзаТстенитеТвТдомаТви.ТобърнетеТкъм специализиранТтърговецТзаТсъветТотносно подходящиТмонтажниТсистеми.</p>	<p>Viktig information Läs noga Spara informationen för framtida bruk</p> <p>(SE) VARNING</p> <p>Allvarliga eller livsfarliga klämskador kan ske om möbler tippar över. För att förhindra att den här möblen tippar måste den fästas permanent vid väggen.</p> <p>Fästbeslag för väggen medföljer inte eftersom olika väggmaterial kräver olika typer av fästbeslag. Använd ett fästbeslag som passar för väggarna hemma hos dig. För rad om lämpliga fästbeslag, kontakta din fackhandlare.</p>	<p>Viktig informasjon Les nøye. Ta vare på denne informasjonen for fremtidig bruk.</p> <p>(NO) ADVARSEL</p> <p>Allvorlige ulykker kan skje som følge av møbler som velt. For a forhindre at dette møbelet faller, ma det festes permanent til veggen.</p> <p>Festemidler for vegg er ikke inkludert fordi ulike vegger krever ulike festemidler. Bruk festemidler som passer til veggene i hjemmet di. Kontakt din nærmeste faghandel for rad om festemidler.</p>	<p>Tärkeää tietoa Lue huolellisesti. Säästä mahdollista myöhempää tarvetta varten.</p> <p>(FI) VAROITUS</p> <p>Huonekalun kaatuminen voi aiheuttaa vakavia tai kuolemaan johtavia vammoja. Kaatumisen estämiseksi huonekalu tulee kiinnittää pysyvästi seinään.</p> <p>Pakkaus ei sisällä seinään kiinnittämistä varten tarvittavia tuuveja ja tulppia, koska erilaisia seinämateriaaleja varten tarvitaan erilaiset kiinnikkeet. Valitse kiinnikkeet kotisi seinämateriaalin mukaan. Arua oikeanlaisten kiinnikkeiden valintaan voit kysyä rautakaupasta.</p>
				<p>Σημαντική πληροφορία Διαβάστε προσεκτικά Φυλάξτε αυτή την πληροφορία για μελλοντική αναφορά.</p> <p>(GR) ΠΡΟΕΙΔΟΠΟΙΗΣΗ</p> <p>Σοβαροί ή μοιραίοι τραυματισμοί από σύνθλιψη, μπορεί να συμβούν από το αναποδογύρισμα επίπλου. Για να προλαμβάνεται το αναποδογύρισμα ενός επίπλου, αυτό θα πρέπει να είναι μόνιμα στερεωμένο στον τοίχο.</p> <p>Τα εξαρτήματα στερέωσης στον τοίχο δεν περιλαμβάνονται, δεδομένου ότι τα διαφορετικά υλικά τοίχων απαιτούν και διαφορετικούς τύπους εξαρτημάτων στερέωσης. Χρησιμοποιήστε εξαρτήματα στερέωσης κατάλληλα για τους τοίχους του σπιτιού σας. Για πληροφορίες σχετικά με τα κατάλληλα εξαρτήματα στερέωσης, συμβουλευθείτε το ειδικό κατάστημα της περιοχής σας.</p>

GB

Instructions for furniture maintenance

- The maintenance consists in regular cleaning the external and internal surfaces of the furniture.
- Remove any?stains or dirt regularly. The fresh stains are usually to be removed easier and completely
- Materials and agents for maintenance:

RECOMMENDED : soft fabric cloths while using proper cleaning and maintenance agents (it is recommended to apply commonly used foams and emulsions) however, before using them it is advisable to do the test on the invisible surface with the agents designed for using for this type of material

UNACCEPTABLE : rough sponges, scratchers, detergents, chemical solvents, polishes powders containing abrasive materials and it is also inadvisable to soak with a great amount of water.

PL

Wskazówki na temat Konserwacji mebli

- Konserwacja polega na regularnym czyszczeniu zewnętrznych i wewnętrznych powierzchni mebla.
- Na bieżąco usuwać plamy i zabrudzenia. Świeże plamy dają się zazwyczaj łatwiej i najczęściej w całości usunąć
- Materiały i środki do konserwacji:

ZALECANE: ściereczki z miękkiej tkaniny z użyciem odpowiednich środków czyszczących - konserwujących (zaleca się stosowanie ogólnie dostępnych pianek i emulsji) jednak przed użyciem środków czyszczących - konserwujących zaleca się przeprowadzenie testu na powierzchni niewidocznej środkami przeznaczonymi dla tego typu naturalnego drewna

NIEDOPUSZCZALNE: twarde gąbki, drapak, detergenty, rozpuszczalniki chemiczne, pasty proszki zawierające środki ściernie oraz niewskazane jest moczenie dużą ilością wody.

DE

Anweisung zur Möbelpflege

- Pflege bedeutet regelmäßige Reinigung der äußeren und inneren Möbeloberfläche
- Flecken und Verschmutzungen laufend entfernen. Neue Flecken lassen sich gewöhnlich leicht und häufig völlig entfernen
- Pflegestoffe und -mittel:

EMPFEHLENSWERT: Lappen aus weichem Stoff und entsprechendes Reinigungspflegemittel (empfehlenswert sind handelsübliche Schäumen und Emulsionen) allerdings wird vor der Anwendung der Reinigungspflegemittel ein Test auf der unsichtbare Oberfläche empfohlen

UNZULÄSSIG: harte Schwämme, Schrubber, Spülmittel, chemische Lösungsmittel, Pasten Pulver mit Schleifmittel sowie Nassmachen mit viel Wasser.

CZ

Pokyny pro údržbu nábytku

- Údržba spočívá v pravidelném čištění vnějších a vnitřních povrchů nábytku.
- Škvry a nečistoty okamžitě odstraňujte. Čerstvé škvry je možné snadněji a nejčastěji zcela odstranit
- Materiály a prostředky k údržbě:

DOPORUČENÉ: hadříky z měkké látky s použitím vhodných čistících a konzervačních prostředků (doporučuje se používání všeobecně přístupných pének a emulzí) avšak před použitím čistících a konzervačních prostředků se doporučuje provést test na neviditelné části, a to prostředky určenými pro tento typ látky.

NEDOVOLENÉ: tvrdé hubky, škrabáky, detergenty, chemické rozpouštědla, pasty prášky obsahující brusné prostředky a nedoporučuje se močit příliš velkým množstvím vody.

FR

Indications concernant la conservation des meubles

- La conservation consiste à un nettoyage régulier des surfaces externes et internes du meuble.
- Effacer les taches et les salures immédiatement. D'habitude, les taches fraîches sont plus faciles à effacer.
- Les matériaux et les substances destinés pour la conservation:

RECOMMANDÉS : les chiffons mous, en utilisant les moyens convenables destinés pour nettoyer et conserver les meubles (il est recommandé d'utiliser les crèmes et émulsions accessibles au marché) pourtant, avant d'utiliser un liquide, il est recommandé de faire un test sur une surface invisible avec des liquides destinés pour ce type de matériau

INADMISSIBLES : éponges dures, radeiro, détergents, dissolvants chimiques, pâtes-poudres contenant les substances abrasives, il n'est recommandé non plus de mouiller les meubles avec de l'eau.

SK

Pokyny pre údržbu nábytku

- Údržba spočívá v pravidelnom čistení vonkajších a vnútorných povrchov nábytku.
- Škvry a znečistenia okamžite odstraňujte. Čerstvé škvry môže sa ľahko a najčastejšie celkom odstrániť.
- Materiály a prostriedky na údržbu:

ODPORUČENÉ: handričky z mäkkej látky s použitím vhodných čistiacich konzervačných prostriedkov (odporuje sa používanie všeobecne dostupných pen a emulzií) avšak pred použitím čistiacich a konzervačných prostriedkov sa doporučuje provést test na neviditeľnej časti, a to prostriedkami určenými pre tento typ látky

NEDOVOLENÉ: tvrdé hubky, škrabáky, detergenty, chemické rozpúšťadla, pasty prášky obsahujúce brusné prostriedky a neodporuje sa močiť príliš veľkým množstvom vody.

NL

Aanwijzingen voor het onderhoud van meubels

- Het onderhoud houdt het regelmatig reinigen van de meubels in.
- Verwijder steeds vlekken en vuil. Verse vlekken zijn gewoonlijk gemakkelijker en vaak in hun geheel te verwijderen.
- Onderhoudsmaterialen en -middelen:

AANBEVOLEN: doeken van zachte stof met reinigingsmiddelen (het gebruik van algemeen verkrijgbare schuim en emulsies wordt aanbevolen). Voer voor het gebruik van de reinigings- en onderhoudsmiddelen een test uit op een onzichtbare plaats met middelen die bestemd zijn voor dat soort materiaal.

AFGERADEN: harde sponzen, krabbers, detergents, chemische oplosmiddelen, pasta's en poeders die schuurmiddelen bevatten. Het wordt ook afgeraden om grote hoeveelheden water te gebruiken.

HR

Savjeti za Održavanje namještaja

- Održavanje se sastoji od redovitih čišćenja vanjskih i unutarnjih površina namještaja.
- Redovito uklanjati mrlje i prljavštine. Svježe mrlje mogu biti lakše i najčešće u potpunosti uklonjene.
- Materijali i sredstva za održavanje:

PREPORUČAMO: korištenje krpica od mekih tkanina i odgovarajuća sredstva za čišćenje i održavanje (preporuča se koristiti pjene i emulzije dostupne u prodaji) - ali prije nego počnete koristiti sredstva za čišćenje i održavanje, preporučljivo je provesti test tog sredstva na nevidljivoj površini materijala.

NEDOVOLJENA SREDSTVA: tvrda spužva, grebalice, deterdženti, hemijska otapala, sredstva u obliku pasti ili praška, koja sadrže abrazivna sredstva, ne preporuča se namakanje velikim količinama vode.

IT

Indicazioni relative alla conservazione dei mobili

- La conservazione consiste in una pulizia sistematica delle superfici interne ed esterne del mobile.
- ?- Togliere le macchie e sporchie immediatamente poiche lo sporco fresco solitamente ed interamente e piu facile da eliminare.
- ?- Materiali e mezzi per la conservazione:

SI RACCOMANDANO: stracci di tessuto morbido con aggiunta di adeguati prodotti per la pulizia e conservazione (si raccomanda l'utilizzo di schiume ed emulsioni generalmente accessibili nel commercio). Tuttavia, prima di applicare tali prodotti, scelti in base alla superficie da trattare, occorre eseguire il test su una zona meno visibile.

SONO VIETATI: spugne dure, raschiatori, detergenti, paste e polveri contenenti sostanze abrasive. Inoltre, e da evitare di bagnare i mobili con l'acqua.

TR

Mobilya bakým talimatý

- Mobilya bakýmý, mobilyanýn iç ve dış yüzeylerini muntazam bir biçimde temizlenmesinden oluşur.
- Oluşan leke ve kirlenmeleri derhal giderin. Taze lekeler genellikle kolay ve tümüyle çykar.
- Mobilya bakým malzeme ve araçları

TAVSÝYELER: yumuřak bez ve uygun temizleme-bakým araçları (piyasadaki köpük ve emülsiyonlar) tavsiye edilir.

ASYL temizlemeye geçmeden önce kullanacađınız ilacı mobilyanýn görünmeyen yüzeyinde test etmeyi ihmal etmeyiniz.

UYARI: sert sünger, tel sünger, tiner, çizici özelliđi olan deterjan, toz deterjan asla kullanmayýn. Mobilya yüzeylerini fazla ıslatmayýn

HU

Bűtor ápolására vonatkozó útmutatók

- Áz ápoláshoz a bűtor külső és belső felületének rendszeres tisztítása tartozik.
- Folyamatosan kell a foltokat és a szennyzedéseket eltávolítani. A friss foltok általában könnyebben és gyakran teljesen eltávolíthatók.
- Ápolási anyagok és szerek:

JAVASOLT: a tisztításhoz puha rongyot (ruhát) és megfelelő ápolási szereket használnak (javasolt a kereskedelemben elérhető habok és emulziók használata) a tisztító-ápolási szerek használata előtt a nem látható (nem szembetűnő) felületen adott szerrel egy próbatesztet kell elvégezni .

TILOS: a kemény szivacs, kaparó, mosószer, vegyi oldószer, sűrűszerkeket tartalmazó porok és paszták használata, a tisztításhoz nem szabad nagy mennyiségű vizet használni és abban zdatni.

RO

Sfaturi pentru întreținerea mobilei

- Întreținerea constă în curățarea regulată a suprafețelor exterioare și interioare ale mobilierului.
- Petele și murdăria trebuie sc îndepărtate imediat. De obicei, petele proaspete pot să fie mai ușor și complet eliminate.
- Materiale și detergenți de întreținere:

RECOMANDATE: ștergerea cu o cârpă moale, și utilizarea unor detergenți pentru curățare și întreținere (este recomandată să utilizați spume disponibile în comerț și emulsii), cu toate acestea, înainte de aplicarea detergenților pentru curățare-întreținere, se recomandă să se efectueze testul pe o suprafață disponibilă invizibilă din acest tip de material

NIȚIODATĂ: bureți duri, lavete abrazive, detergenți, solvenți, substanțe chimice, pulberi, paste care conțin substanțe abrazive; nu este recomandată nici umezirea cu o cantitate mare de apă

ES

Indicaciones para conservación de los muebles

- La conservación consiste en la limpieza corriente de las superficies externas e internas del mueble.
- Quitense las manchas y suciedades según vayan apareciendo. Las manchas recientes suelen quitarse ligera y completamente.
- Materiales y productos para conservación:

SE RECOMIENDAN: trapo de tela suave con la utilización de los productos correspondientes de limpieza y conservadores (se recomiendan las espumas y emulsiones disponibles en el mercado). No obstante, antes de usar el producto de limpieza y conservador se recomienda hacer una prueba en la superficie invisible con los productos apropiados para este tipo de materia.

NO SE ADMITE EL USO DE: esponjas duras, metálicas, detergentes, disolventes, cremas, polvos que contienen agentes abrasivos. Tampoco se puede mojar el mueble con demasiada cantidad de agua.

RU

РекомендацийпоКуходуКзаМебелью

- УходТзаТмебельюТпредусматриваетТрегулярнуюТпротиркуТвнешнейТиТвнутреннейТповерхностиТмебели.
- ТпятнаТиТзагрязненияТснимаютТсразуТже. ТсвежиеТпятнаТудаляютсяТлегчеТиТзачастуюТполностью.
- ТматериалыТиТсредстваТпоТуходу:

РЕКОМЕНДУЕМЫЕ: тряпочкиТизТмягкойТтканиТсТприменениемТсоответственныхТчистяще-консервирующих средствТ(рекомендуетсяТприменениеТобщедоступныхТпенокТиТэмульсий). Тоднако, ТпередТприменениемТчистящего-консервирующегоТсредстваТследуетТпровестиТтестТнаТзакрытойТповерхностиТмебели.

НЕКРЕКОМЕНДУЕМЫЕ: жесткиеТгубки, Тнаждаки, Тдeterгенты, ТхимическиеТрастворители, ТпастыТиТпорошки сТсодержаниемТабразивныхТвеществ. ТнеТдопускатьТскопленияТводыТнаТповерхностиТмебели.

<p>(PL) Informacja o produkcie z drewna litego i okleiny naturalnej: Drewno jest żywym produktem natury o różnych kolorach i strukturach. Powstaje ono przez naturalne zrosty i rozgałęzienia. Śęki oraz różnorodność usłojenia są charakterystycznymi cechami naturalnego drewna i nie dają podstawy do reklamacji. Zmiana klimatu może prowadzić do powstawania na powierzchni mebla małych rys lub wypaczania. Drewno z każdego pnia ma inny wygląd, inne usłojenie i kolorystykę. Różnice kolorystyczne po wybarwieniu występujące w okleinie czy też drewnie są naturalną cechą drewna i nie podlegają reklamacji. Każde drewno reaguje na zmiany otoczenia i wilgotności powietrza. Optymalna temperatura około 20°C i wilgotności 40-70% powoduje tylko nieznaczącą pracę drewna. Konserwacja polega na regularnym czyszczeniu zewnętrznych i wewnętrznych powierzchni mebla. Na bieżąco usuwać plamy i zabrudzenia. Zalecane materiały i środki konserwacji: ściereczki z miękkiej tkaniny z użyciem odpowiednich środków czyszcząco-konserwujących. Przed użyciem przeprowadzić test na nie widocznej powierzchni.</p>	<p>(EN) Solid wood and natural veneer product information: Wood is a living product of nature that can vary in colour and structure. It is formed through natural fusions and bifurcations. Knots and diverse figures are typical features of natural wood, and cannot be complained about. Change in climate can result in small cracks and warps on the surface of the furniture. Each trunk yields wood of different appearance, figure and colour. Differences in colour that can appear on both veneer and wood after dyeing are a natural feature of wood and cannot be complained about. Every type of wood responds to changes in the environment and air humidity. At an optimum temperature of 20°C and a humidity of 40-70%, wood works only slightly. Maintenance involves regular cleaning of the external and internal surfaces of the furniture. Remove stains and dirt on a regular basis. Recommended materials and maintenance products: soft cloths used with appropriate cleaning and maintenance products. Test them in a non-prominent place before use.</p>
<p>(HR) Podatci o proizvodu od punog drva i prirodnog furnira: Drvo je živi proizvod prirode i može varirati u boji i strukturi. Stvara se kroz prirodno stapanje i račvanje. Čvorovi i različiti uzorci ubičajene su karakterističke prirodno drva, stoga ne mogu biti predmet prigovora. Promjene u klimi mogu prouzročiti male pukotine i izvitoperenosti na površini namještaja. Svako drvo daje drvenu građu drugačijeg izgleda, oblika i boje. Razlike u boji, koje se mogu pojaviti i na furniru i na drvu nakon bojanja, prirodna su značajka drva i na to se ne može prigovoriti. Svaka vrsta drva reagira na promjene u okolini i vlažnosti zraka. Na optimalnoj temperaturi od 20°C i vlažnosti zraka od 40-70 %, promjene na drvu su neznatne. Održavanje uključuje redovito čišćenje vanjskih i unutarnjih površina namještaja. Redovito uklanjajte mrljice i prašinu. Preporučena sredstva i materijali za čišćenje: mekane krpe korištene zajedno s prikladnim sredstvima za čišćenje i održavanje. Isprobajte ih najprije na površini koja nije vidljiva.</p>	<p>(CS) Informace o výrobku z masivního dřeva a přírodní dýhy: Dřevo je živý produkt přírody s různými barvami a strukturami. Se vytváří přirozenými srůsty a větvení. Dřevy a různé letokruhy jsou typické prvky přírodního dřeva a nedávají důvod k reklamaci. Změna klimatu může vést ke vzniku na povrchu nábytku drobných prasklin nebo deformace. Každý kmen dává dřevo různého vzhledu, letokruhu a barvy. Rozdíly v barvě po zbarvení vyskytující se jak v dýhy a ve dřevě jsou přirozenou vlastností dřeva a nedávají důvod k reklamaci. Každý druh dřeva reaguje na změny v životním prostředí a vlhkosti vzduchu. Při optimální teplotě 20°C a vlhkosti 40-70% dřevo funguje jen mírně. Údržba zahrnuje pravidelné čištění vnějších i vnitřních povrchů nábytku. Odstraňte pravidelně skvrny a nečistoty. Doporučené materiály a prostředky na údržbu: utěrky z měkké tkaniny s příslušnými prostředky čistící a na údržbu. Před použitím udělejte si test na skryté oblasti.</p>
<p>(FR) Information sur le produit en bois massif et placage naturel : Le bois est un produit vivant de la nature qui peut varier en couleur et structure. Il se forme par des groupements et branchements naturels. Les nœuds et les diverses statures sont les caractéristiques typiques du bois naturel et ne peuvent pas faire l'objet d'une réclamation. Les changements climatiques peuvent avoir pour effet de petites fissures et gauchissements sur la surface du meuble. Chaque tronçon donne un bois d'apparence, de stature et de couleur différente. Les différences de couleur qui peuvent se produire, après la teinture, autant sur le placage que sur le bois sont une caractéristique naturelle du bois et ne peuvent pas faire l'objet d'une réclamation. Chaque type de bois réagit aux changements environnementaux et d'humidité de l'air. A une température optimale de 20°C et une humidité de 40-70%, le bois ne travaille pas que très légèrement. L'entretien consiste à nettoyer régulièrement les surfaces internes et externes des meubles. Enlever régulièrement les taches et la saleté. Matériaux et produits d'entretien recommandés: lingettes douces avec les produits de nettoyage et d'entretien appropriés. Avant de les utiliser, il faut les tester à un endroit invisible.</p>	<p>(ES) Información sobre el producto de madera maciza y chapa natural: La madera es un producto vivo de la naturaleza que puede variar en color y estructura. Se forma a través de fusiones y ramificaciones naturales. Nudos y diversas figuras son características típicas de la madera natural y no pueden ser objeto de reclamación. Cambios climáticos pueden resultar en pequeñas grietas y deformaciones en la superficie del mueble. Cada tronco da una madera de apariencia, figura y color diferentes. Las diferencias de color que pueden aparecer tanto en la chapa como en la madera después de la decoloración son una característica natural de la madera y no pueden ser objeto de reclamación. Cada tipo de madera responde a los cambios en el medio ambiente y la humedad del aire. A una temperatura óptima de 20 ° C y una humedad del 40-70%, la madera trabaja sólo un poco. El mantenimiento consiste en limpiar regularmente las superficies externas e internas de los muebles. Elimina manchas y ensuciamientos sobre. Materiales y productos de mantenimiento recomendados: paños blandos con productos de limpieza y mantenimiento adecuados. Antes de su uso, pruébalos en un lugar invisible.</p>
<p>(NL) Informatie over het product uit massief hout en natuurlijk fineer: Hout is een levend product van de natuur dat kan variëren in kleur en structuur. Het is gevormd door natuurlijke fusies en opsplitsingen. Kwasten en verschillende jaarringen zijn typische kenmerken van natuurlijk hout en kan daarover niet worden geklaagd. Klimatologische veranderingen kunnen leiden tot het optreden van kleine scheurtjes en krommingen op het oppervlak van het meubel. Elke stam geeft hout van verschillend uiterlijk, figuur en kleur. Verschillen in kleur die zich na het verven kunnen voordoen op zowel fineer en hout zijn een natuurlijk kenmerk van hout en kan daarover niet worden geklaagd. Elk type van hout reageert op veranderingen in het milieu en de luchtvochtigheid. Bij een optimale temperatuur van 20 ° C en een luchtvochtigheid van 40-70% werkt hout slechts in geringe mate. Het onderhoud bestaat uit het regelmatig reinigen van de uitwendige en inwendige oppervlakken van het meubel. Verwijder vlekken en vuil op een regelmatige basis. Aanbevolen materialen en onderhoudsproducten: zachte lappen met de juiste reinigings- en onderhoudsproducten. Test ze in een niet prominente plaats voor gebruik.</p>	<p>(DE) Angaben zum Produkt aus Vollholz und natürlichem Furnier: Holz ist ein lebendiges Produkt der Natur, das farblich und strukturell variieren kann. Es wird durch natürliche Verschmelzungen und Verzweigungen gebildet. Äste und verschiedene Wuchsmarkmal sind typische Merkmale natürlichen Holzes und können keinen Anlass für Beschwerden geben. Klimaänderungen können zu geringe Risse und Vorwölbungen auf der Möbeloberfläche verursachen. Jeder Stamm gibt Holz mit unterschiedlichem Erscheinungsbild, Wuchs und Farbton. Abweichungen in Farbe, die nach Ausfärbung sowohl auf dem Furnier als auch auf dem Holz auftreten können, sind ein natürliches Merkmal des Holzes und können keinen Anlass für Beschwerden geben. Jede Holzart reagiert auf Umwelt- und Luftfeuchteveränderungen. Bei einer optimalen Temperatur von 20°C und einer Feuchte von 40-70% arbeitet Holz nur geringfügig. Zur Instandhaltung gehört regelmäßiges Reinigen der Außen- und Innenflächen von Möbeln. Entfernen Sie Flecken und Schmutz regelmäßig. Empfohlene Materialien und Instandhaltungsmittel: weiche Wischlappen zusammen mit entsprechenden Reinigungs- und Instandhaltungsmitteln. Testen Sie diese vor dem Gebrauch an einer unsichtbaren Stelle.</p>
<p>(RU) Информационно о продукте из массивного натурального дерева и натурального фанера: Древесина является живым природным продуктом, который может различаться по цвету и структуре. Он образуется в результате сращивания и разветвления. Узлы и различные рисунки годичных колец являются типичными признаками натурального дерева, поэтому они не являются предметом претензий. Изменения климата могут привести к образованию небольших трещин и искривлений на поверхности мебели. Каждая ствол дает древесину с разным внешним видом, рисунком и цветом. Различия в цвете после окраски, как на фанере, так и на дереве, являются естественными признаками натурального дерева и не являются предметом претензий. Каждый тип древесины реагирует на изменения в окружающей среде и влажности воздуха. При оптимальной температуре 20 ° C и влажности 40-70% древесина работает только незначительно. Уход за мебелью включает регулярную чистку внутренних и внешних поверхностей мебели. Удаляйте регулярно пятна и грязь. Рекомендуемые материалы и средства для ухода: мягкие салфетки с соответствующими средствами для очистки и ухода. Перед использованием их необходимо протестировать в незаметном месте.</p>	<p>(RO) Informații despre produsele din lemn masiv și din furnir natural: Lemnul este un produs viu al naturii ale cărei structură și culoare sunt variabile. la naștere prin fuziuni și bifurcări naturale. Nodurile și diversele modele sunt caracteristici tipice ale lemnului natural și nu pot face obiectul sesizărilor. Modificarea climatului poate determina mici crăpături și deformări pe suprafața mobilei. Fiecare trunchi produce lemn cu înfățișarea, modelul și culoarea diferite. Diferențele de culoare care pot apărea atât pe furnir cât și pe lemn în urma uscării reprezintă o caracteristică naturală a lemnului și nu se pot face sesizări în acest sens. La o temperatură optimă de 20°C și la o umiditate de 40-70%, lemnul suferă numai modificări ușoare. Întreținerea presupune curățarea periodică a suprafețelor interioare și exterioare ale mobilierului. Îndepărtați regulat petele și murdăria. Materiale și produse de întreținere recomandate: cârpe moi și produse de curățare și întreținere adecvate. Testați-le în zone neexpușe privirii înainte de a le utiliza.</p>
<p>(SK) Informácie o výrobku z masívneho dreva a prírodnej dýhy Drevo je živý produkt prírody s rôznymi farbami a štruktúrami. Sa vytvára prirodzenými zrasty a vetvenia. Hrčče a rôzne letokruhy sú typické prvky prírodného dreva a nedávajú dôvod k reklamáciám. Zmena klímy môže viesť k vzniku na povrchu nábytku drobných prasklín alebo deformácie. Každý kmeň dáva drevo rôzneho vzhľadu, letokruhov a farby. Rozdiely vo farbe po sfarbení vyskytujúce sa ako v dýhy a v dreve sú prirodzenou vlastnosťou dreva a nedávajú dôvod k reklamáciám. Každý druh dreva reaguje na zmeny v životnom prostredí a vlhkosti vzduchu. Pri optimálnej teplote 20°C a vlhkosti 40-70% drevo funguje len mierne. Údržba zahŕňa pravidelné čistenie vonkajších i vnútorných povrchov nábytku. Odstráňte pravidelné skvrny a nečistoty. Doporučené materiály a prostriedky na údržbu: utierky z mäkkej tkaniny s príslušnými prostriedkami čistiacimi a na údržbu. Pred použitím urobte si test na skryté oblasti.</p>	<p>(TR) Sert ağşap ve dogal ağaç kaplama hakkında ürün bilgisi: Renk ve yapı itibariyle değişkenlik gösterenler ağşap, doğanın canli bir ürünüdür. Dogal füzyonlar ve bifürkasyon yoluyla biçimlendirilir. Dogal ağşabin tipik bir özelliği budak oyuguna ve farkli desenlere sahip amasidir, bu olmasi gereken bir özelliiktir. Sicaklik degisimi mobilya yüzeyinde ufak çatlaklara ve egriemelere sebep olabilir. Ağaç gövdeleri ağşaba farkli bir görünüm, desen ve renk kazandırır. Boyamadan sonra ağşap ve ağaç kaplamada oluşabilecek renk farklılıkları ağşabin dogal bir özelliğinden kaynaklıdır, bunda şüphe yoktur. Ağşabin tüm çeşitleri sicaklık ve nem degisiminden etkilenir. Ağşap için uygun sicaklik 20°C ve nem oranı %40-70 arasıdır. Mobilyanın hem iç hem de dış yüzeyinin düzenli bir şekilde temizlenmesi gerekir. Leke ve kirleri muntazaman siliniz. Onerilen materyal ve bakım ürünleri: Uygun temizleme ve bakım ürünlerini yumuşak bir bez yardımıyla uygulayınız. Ürünleri uygulamadan önce ufak bir yüzeyde test ediniz.</p>
<p>(HU) Tájékoztató a tömör fából és természetes furnélemezből készült termékről. A fák a természetben található élőlények, amelyek különféle színűek és szerkezetűek lehetnek. A természetben a sejtek egyesülése és osztódása révén keletkeznek. A természetes fa jellemzői a csomók és a különféle alakzatok, melyek ellen kifogást emelni nem lehet. Az éghajlati változás következtében kisebb repedések és vetemedések megjelenhetnek a bútor felületén. Az egyes fátörzsekből származó faanyagok eltérő megjelenésűek, mintázatúak és színűek. A festést követően a furnérből származó faanyagok eltérő megjelenésűek, mintázatúak és színűek. Minden faanyagra hatással van a környezeti változás és a levegő nedvességtartalma. Az optimális 20°C-os hőmérsékletű és 40-70 %-os nedvességtartalmú levegő csupán némiuglen van kihatással a fára. Az ápolás során a bútor külső és belső felületeit a szokásos módon kell tisztítani. Rendszeres időközönként távolítsa el a foltokat és a szennyeződéseket. Az ápoláshoz ajánlott anyagok és tisztítószer: puha törölröngy, valamint megfelelő tisztító- és ápolószer. Felhasználásuk előtt egy nem szembetűnő helyen végezzen próbatisztítást!</p>	<p>(IT) Informazioni sul prodotto in legno massiccio e impiallacciatura naturale: Il legno è un prodotto vivente della natura che può variare in colore e struttura. E formato attraverso fusioni e diramazioni naturali. Nodi e differenti figurezioni sono le caratteristiche tipiche del legno naturale e non possono essere oggetto di un reclamo. Cambiamenti climatici possono avere come conseguenza spaccature e imbarcamenti piccoli sulla superficie dei mobili. Ogni fusto da un legno di differente aspetto, figurazione e colore. Differenze di colore che possono presentarsi sia sull' impiallacciatura sia sul legno dopo la decolorazione sono una caratteristica naturale del legno e non possono essere oggetto di un reclamo. Ogni tipo di legno risponde ai cambiamenti ambientali e di umidità dell' aria. Con una temperatura ottimale di 20°C e un' umidità di 40-70%, il legno lavora solo poco. La manutenzione consiste nella pulizia regolare delle superfici esterne ed interne del mobile. Rimuovere regolarmente macchie e sporchie. Materiali e mezzi di manutenzione raccomandati: stracci morbidi con mezzi di pulizia e di manutenzione adatti. Prima dell'uso provarle in un luogo invisibile.</p>