

ANDY

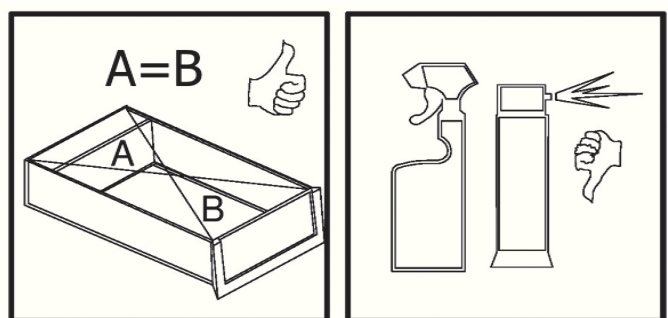

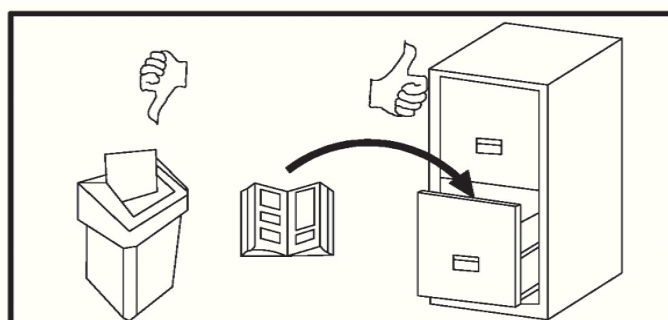

G1/G2	870 x 555 mm	2	1/1
G3	567 x 534 mm	1	1/1
G4	567 x 150 mm	1	1/1
G5/G6	567 x 95 mm	2	1/1
G7	720 x 578 mm	1	1/1
G8	600 x 600 mm	1	1/1
G9	596 x 140 mm	1	1/1
G10/G11	400 x 80 mm	2	1/1
G12	510 x 80 mm	1	1/1
G13	541 x 406 mm	3	1/1
G14	596 x 283 mm	2	1/1
G15/G16	400 x 180 mm	4	1/1
G17	510 x 180 mm	2	1/1

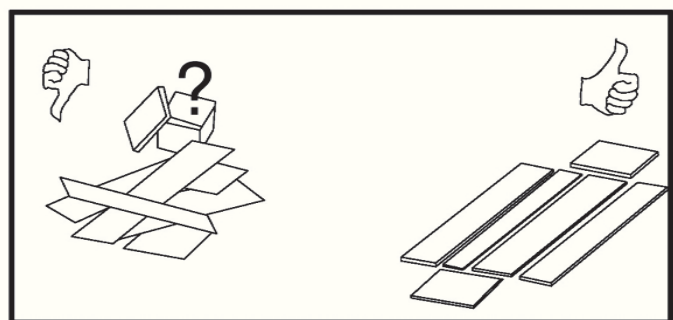
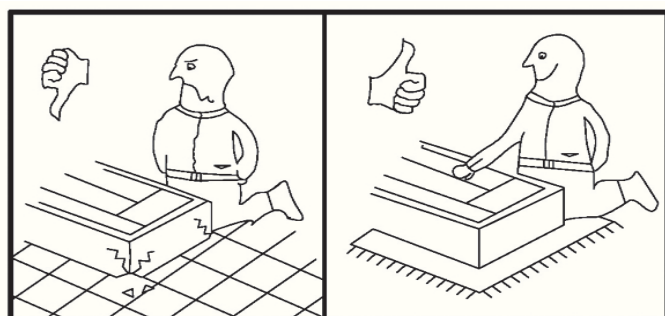
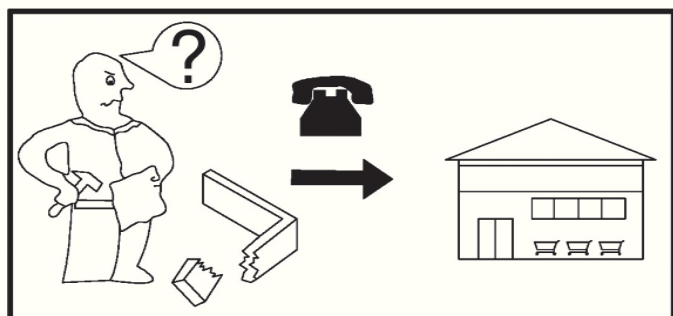
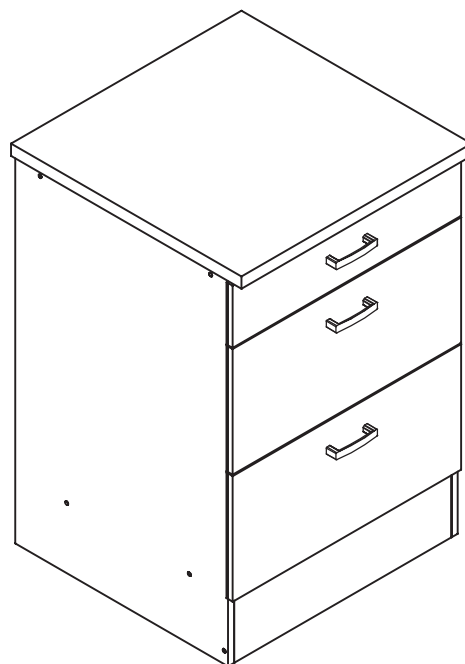
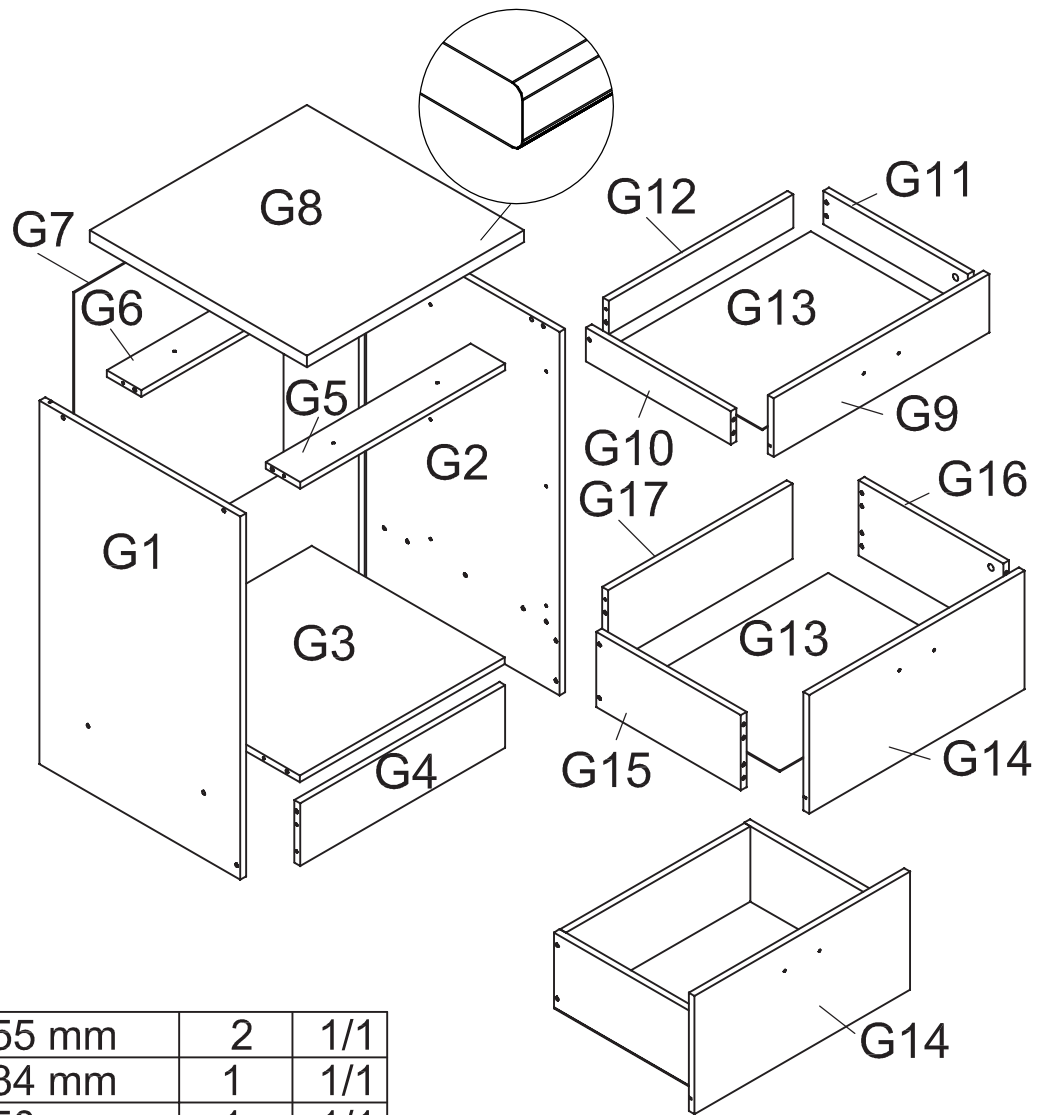
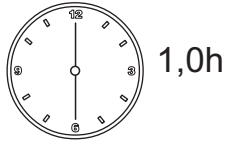
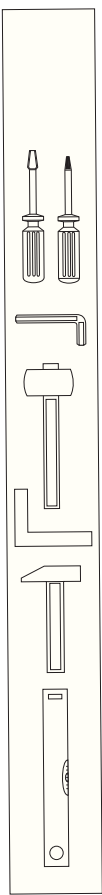