

SIENA 41M

OPTION L

OPTION R

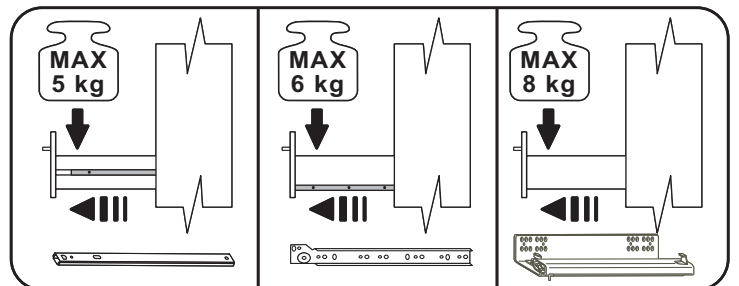
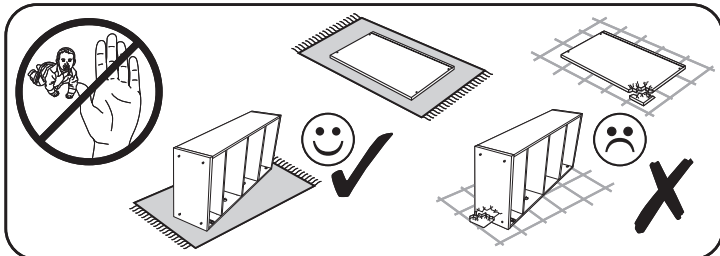
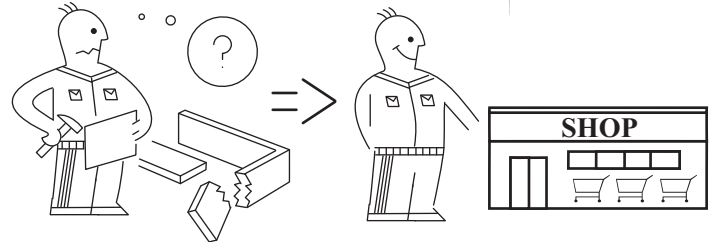
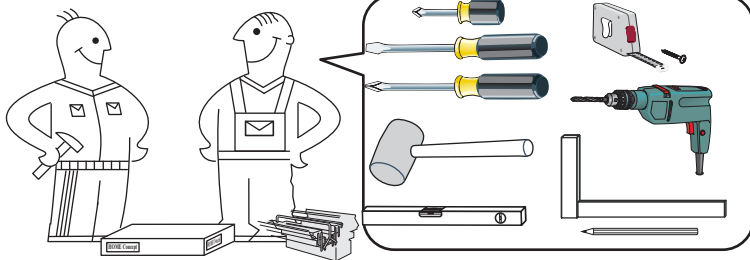
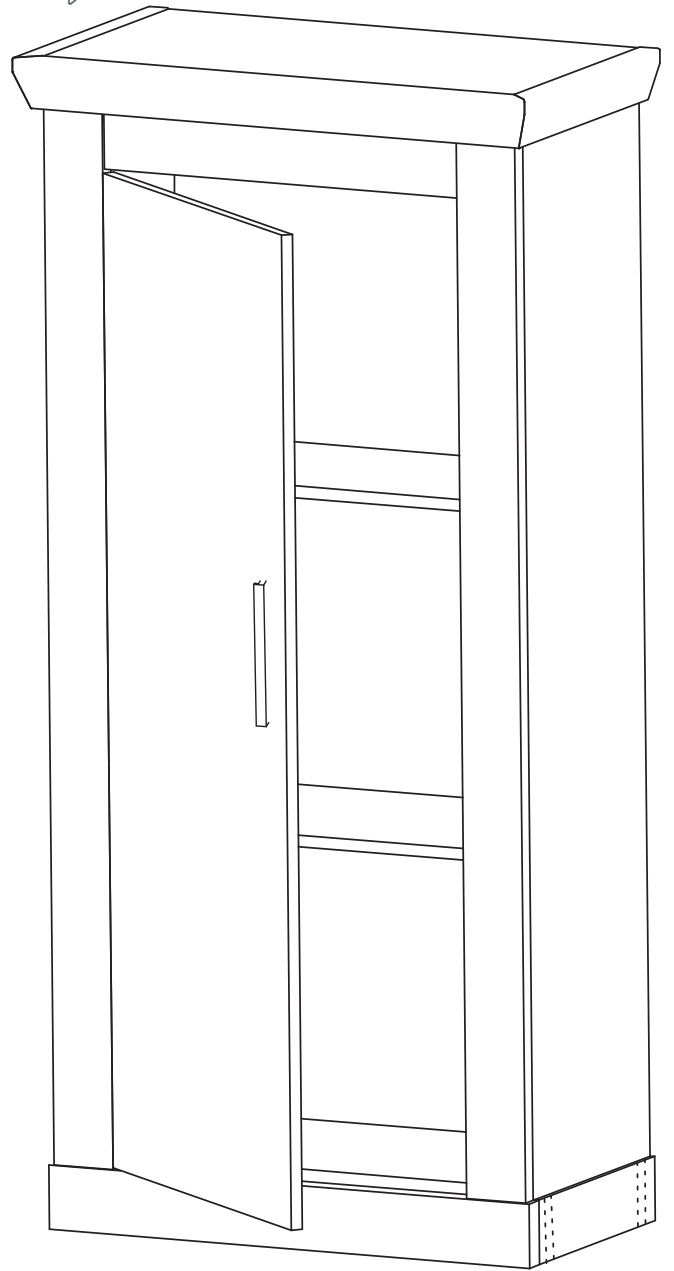
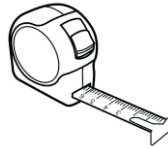
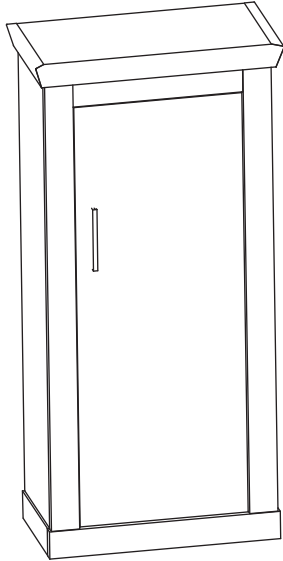
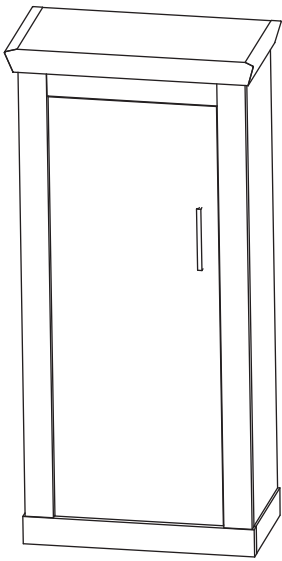

SIENA 41M

max.



MHC3

MHC4

MHC8

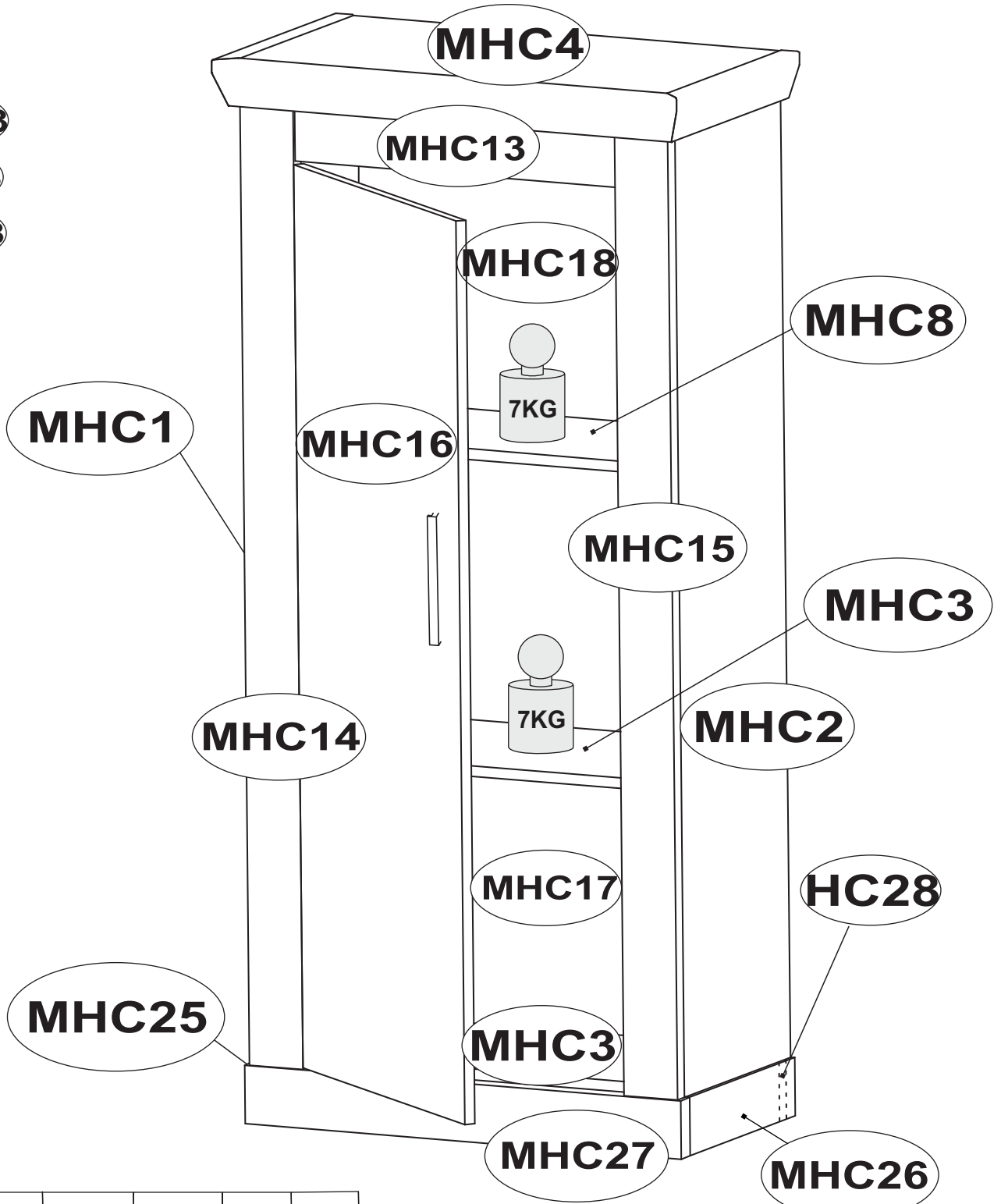



MHC1	x1	1361	320	15	1/1
MHC2	x1	1361	320	15	1/1
MHC3	x2	611	299	15	1/1
MHC4	x1	705	373	65	1/1
MHC8	x1	610	267	15	1/1
MHC13	x1	483	124	18	1/1
MHC14	x1	1361	80	22	1/1
MHC15	x1	1361	80	22	1/1

MHC16	x1	1231	477	15	1/1
MHC17	x1	421	623	3	1/1
MHC18	x1	945	623	3	1/1
MHC25	x1	313	80	32	1/1
MHC26	x1	313	80	32	1/1
MHC27	x1	655	80	32	1/1
MHC28	x1	590	80	15	1/1

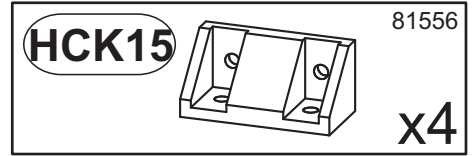
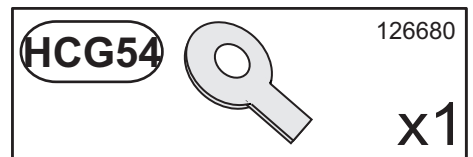
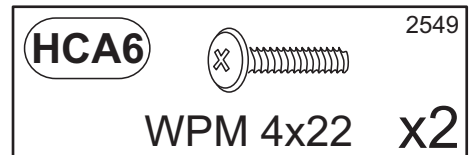
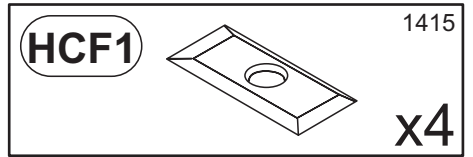
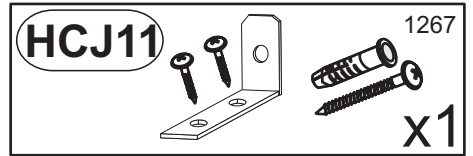
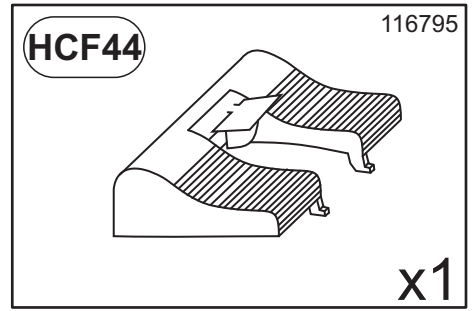
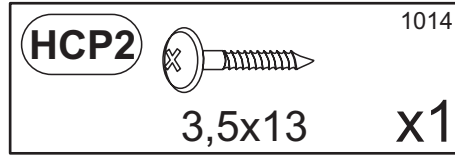
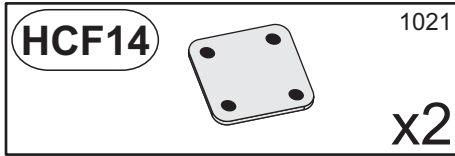
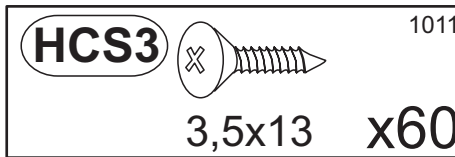
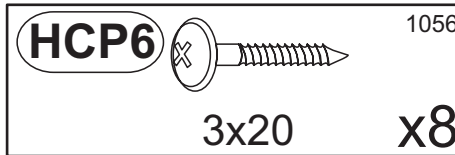
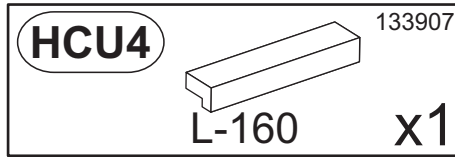
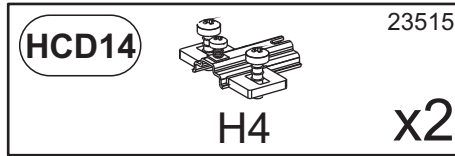
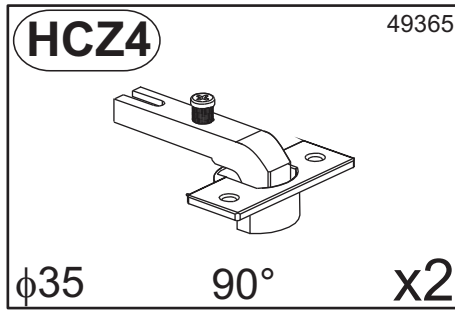
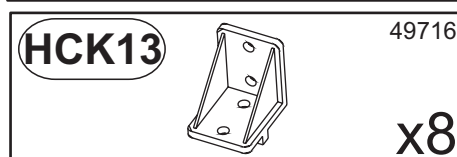
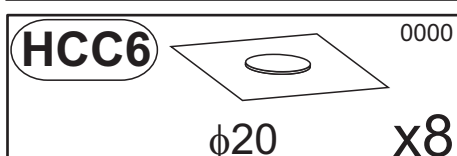
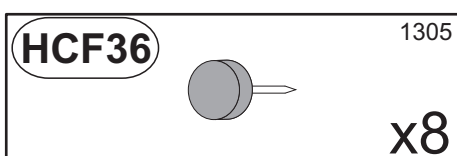
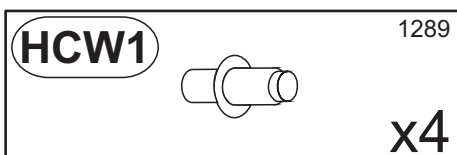
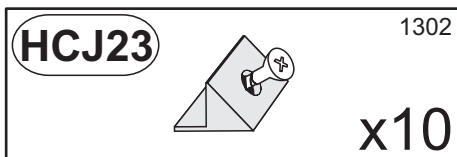
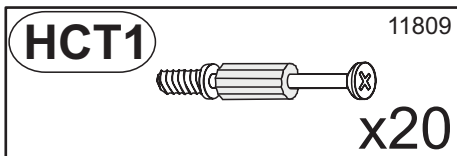
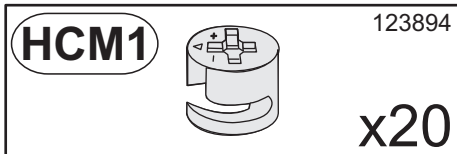
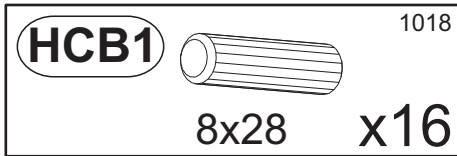
SIENA 41M



1

HCM1		123894	x4
HCK15		81556	x2
HCS3		1011	x4
		3,5x13	

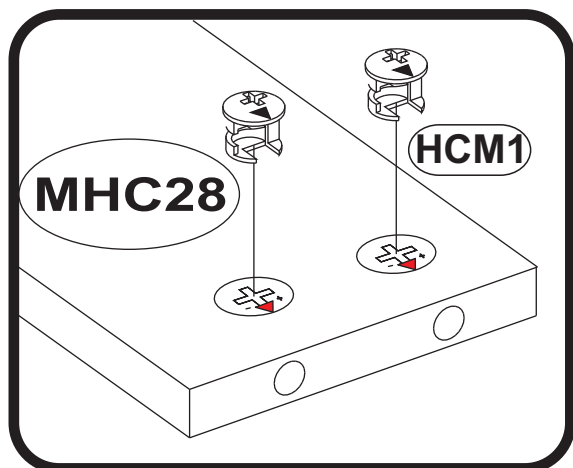
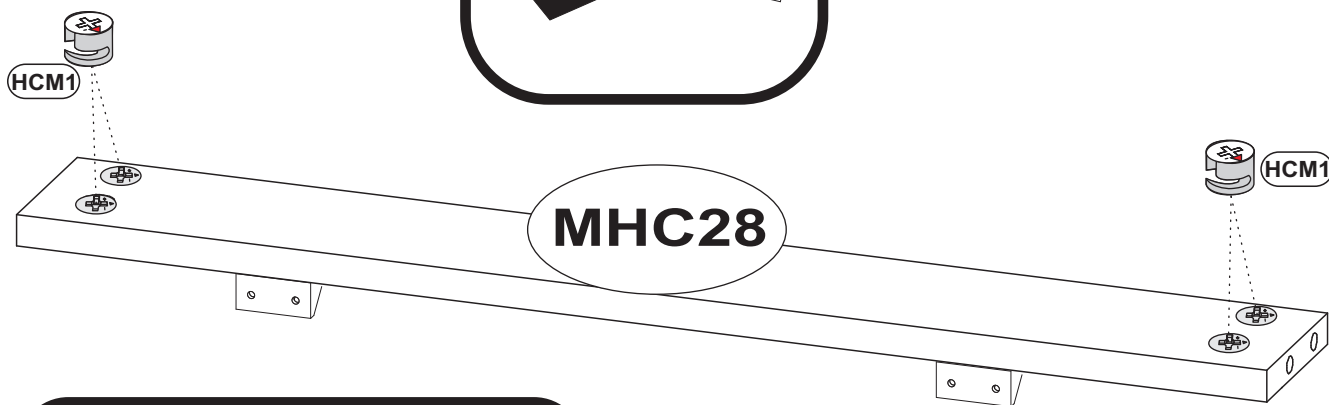
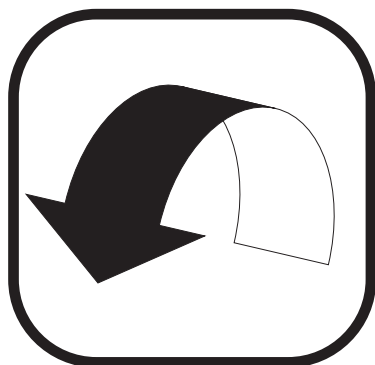
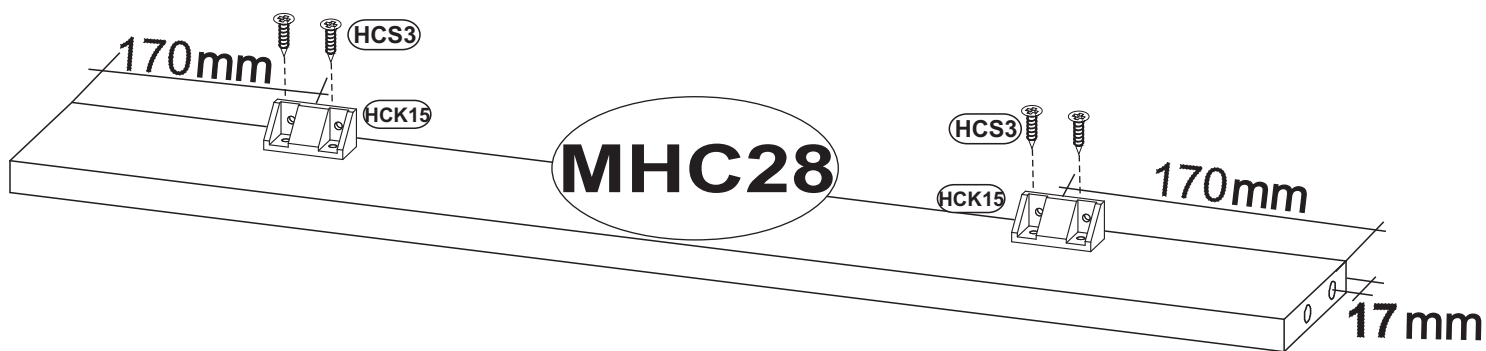
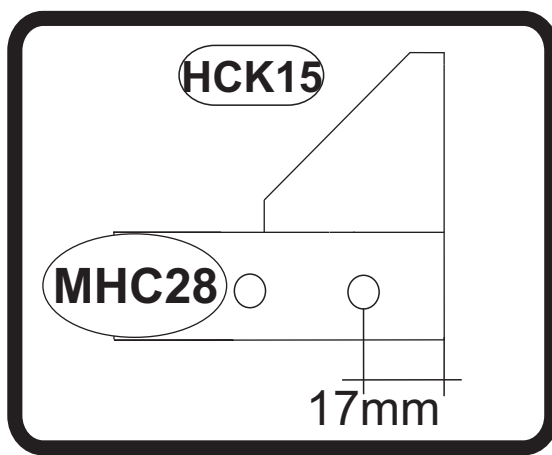
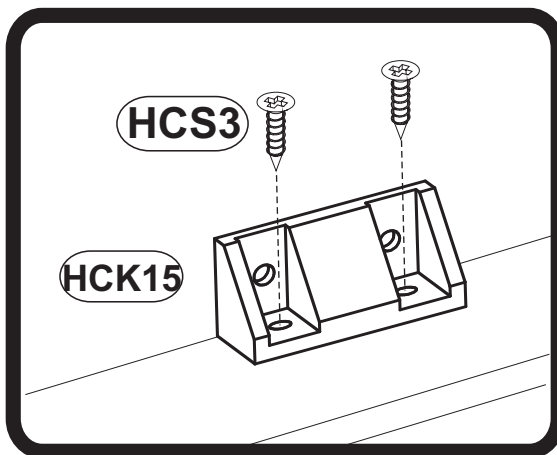

2

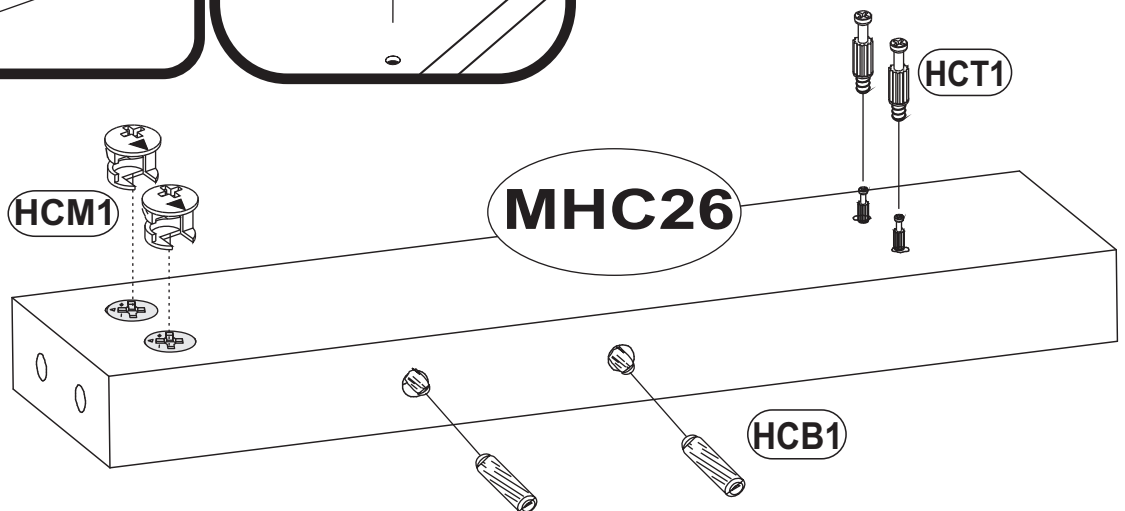
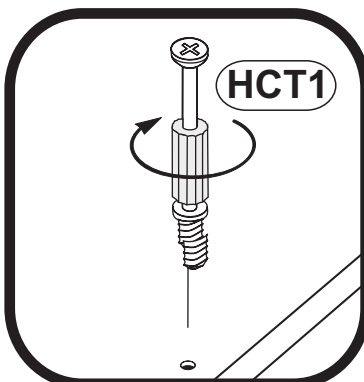
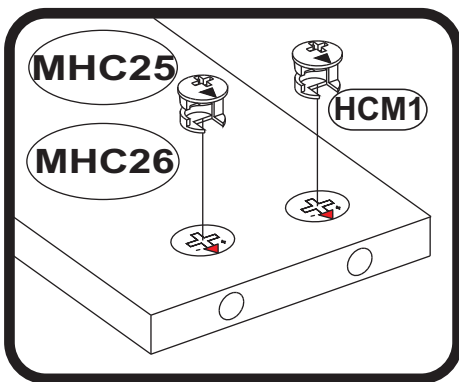
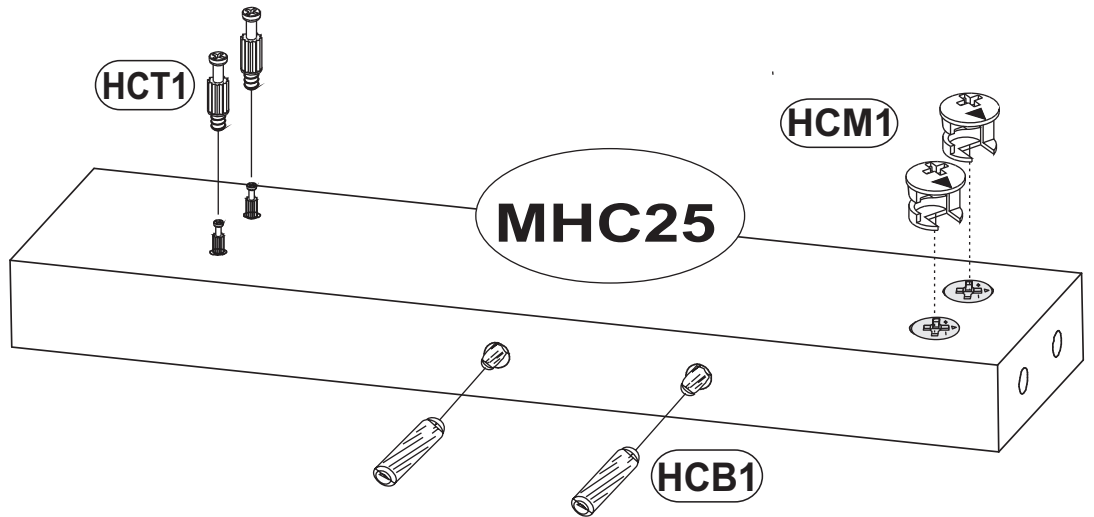
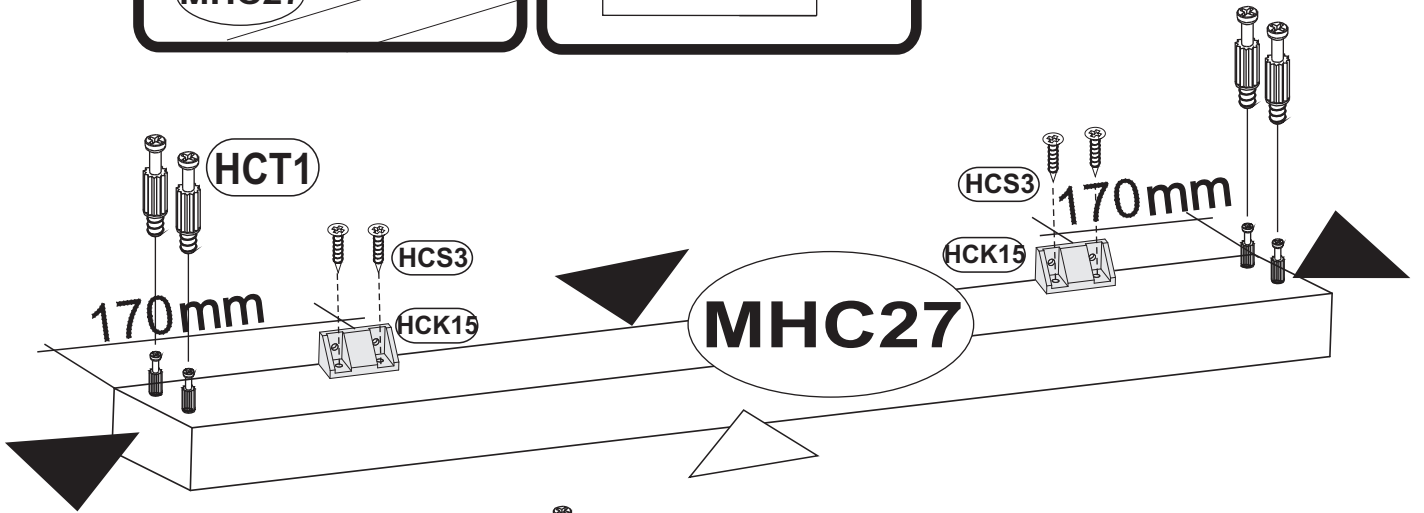
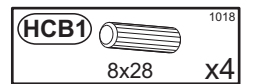
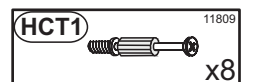
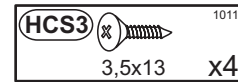
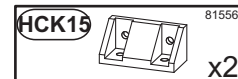
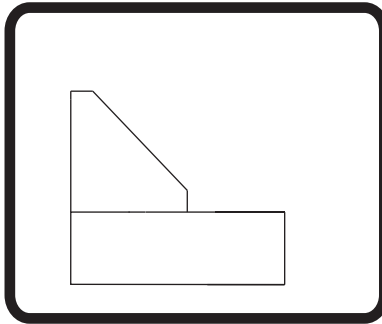
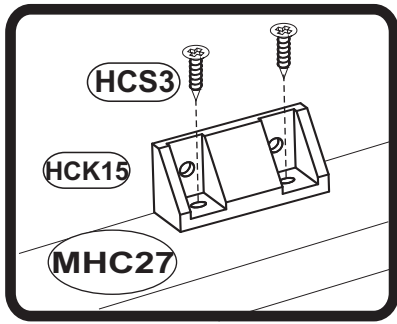

3

HCF36 1305
4x30 x8

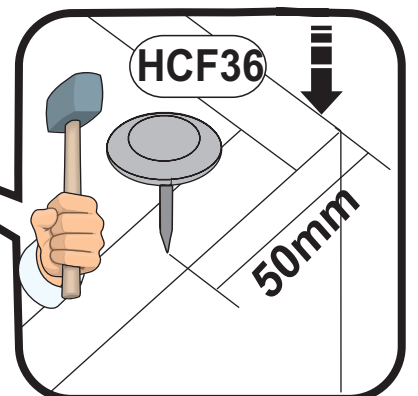
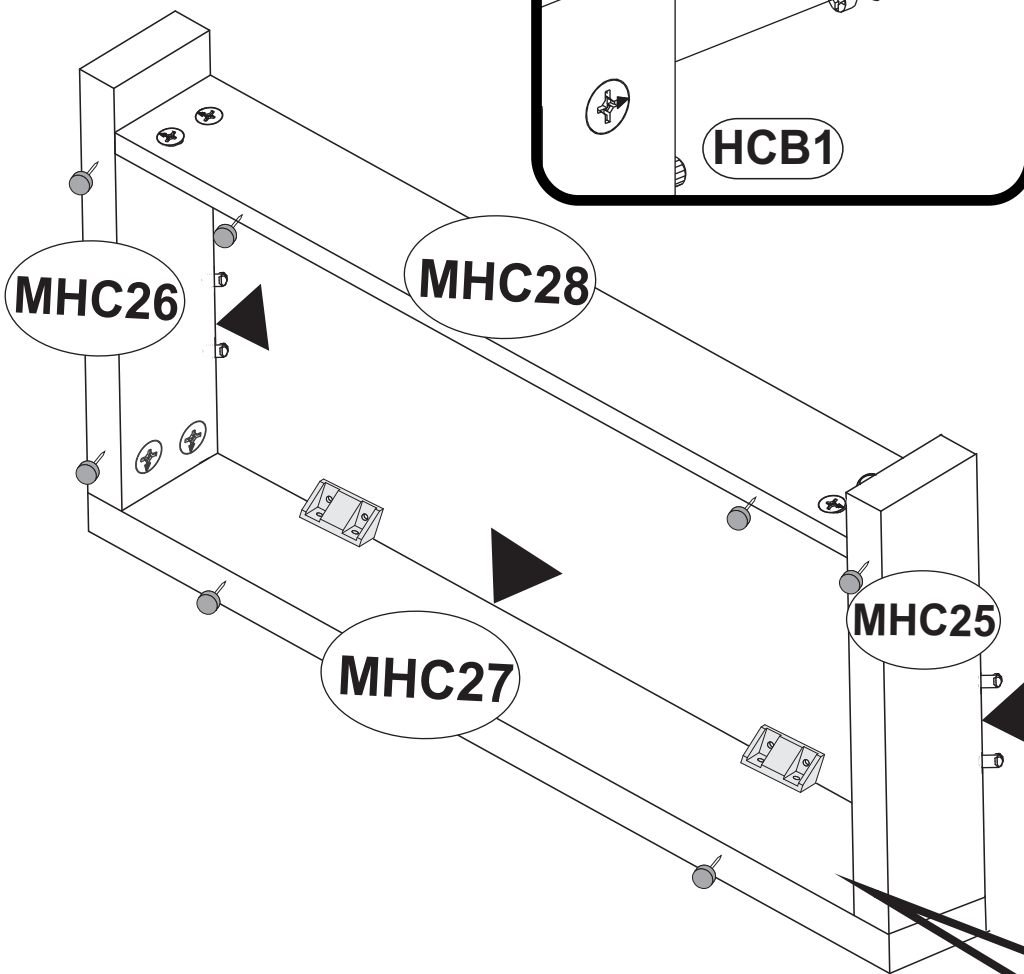
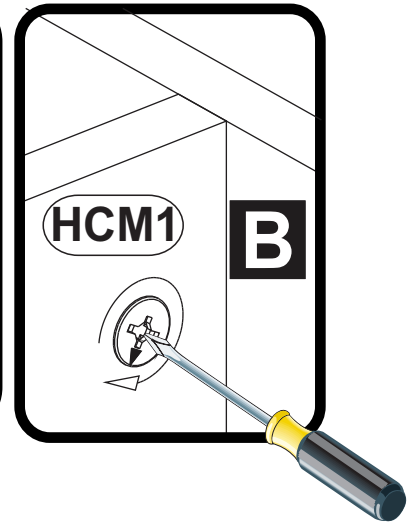
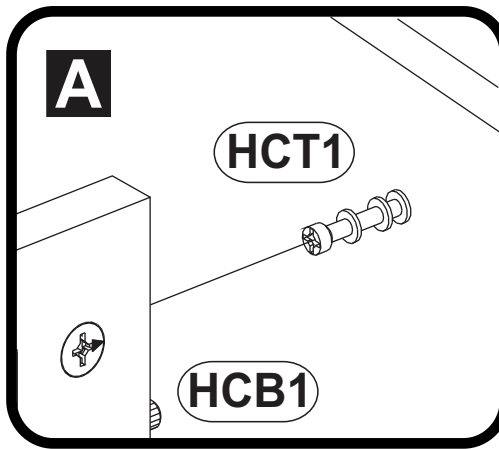
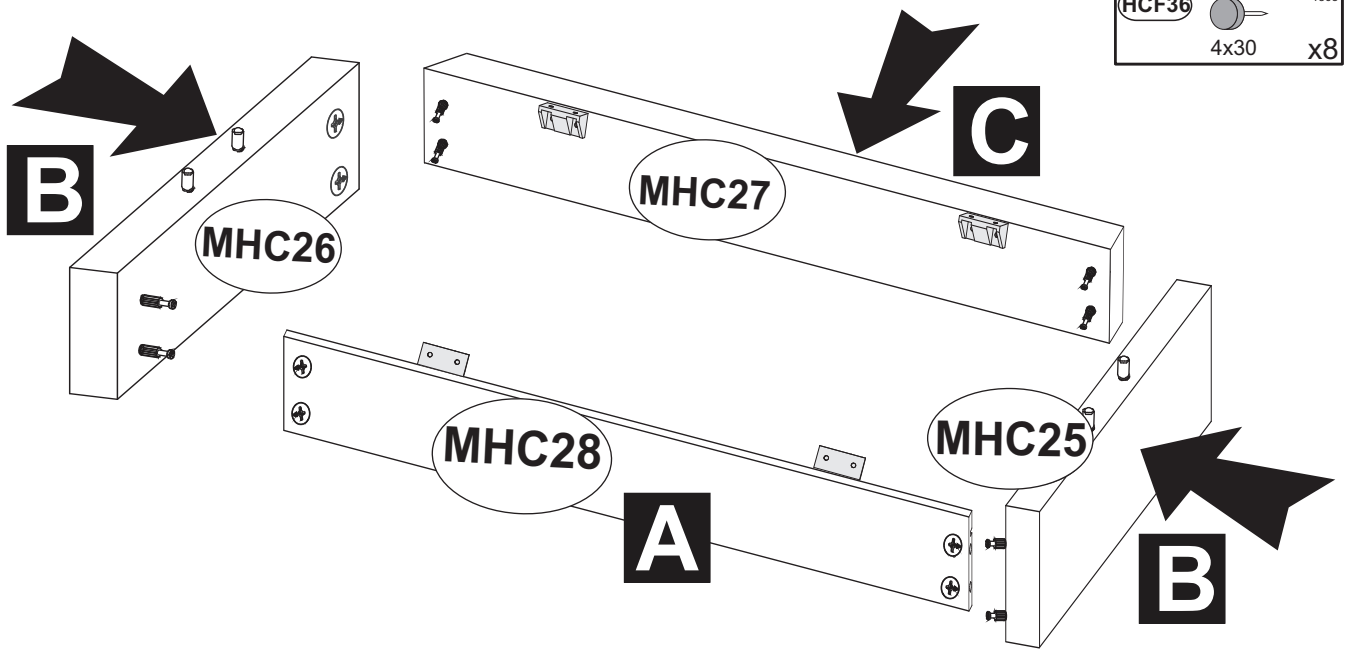

4

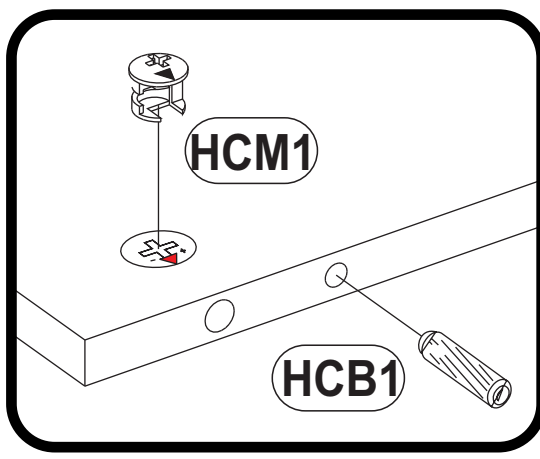
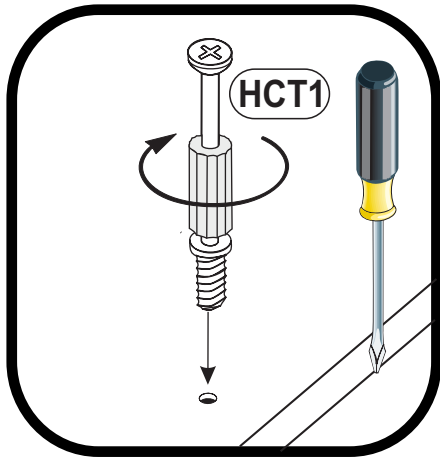

HCB1		1018
	8x28	x4
HCM1		123894
		x4
HCT1		11809
		x8

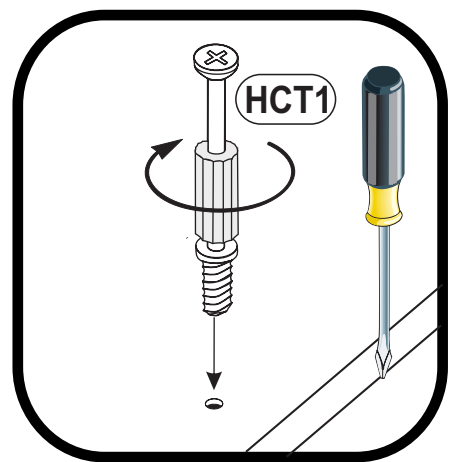
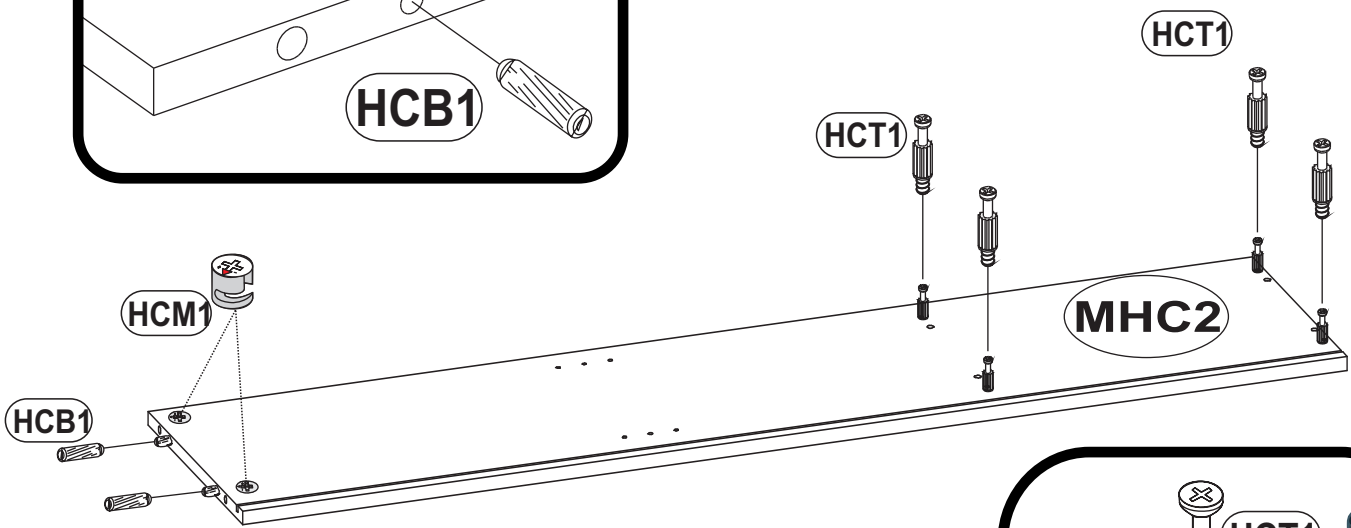
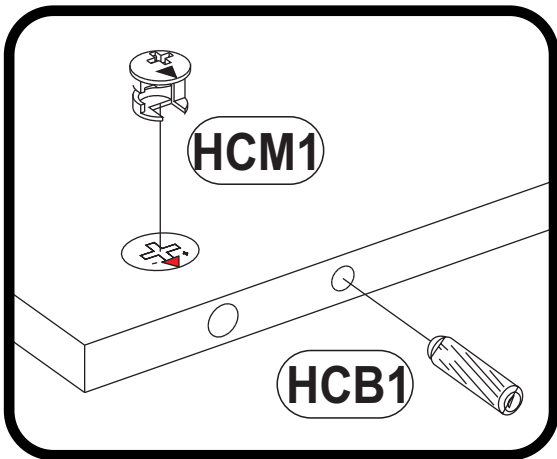
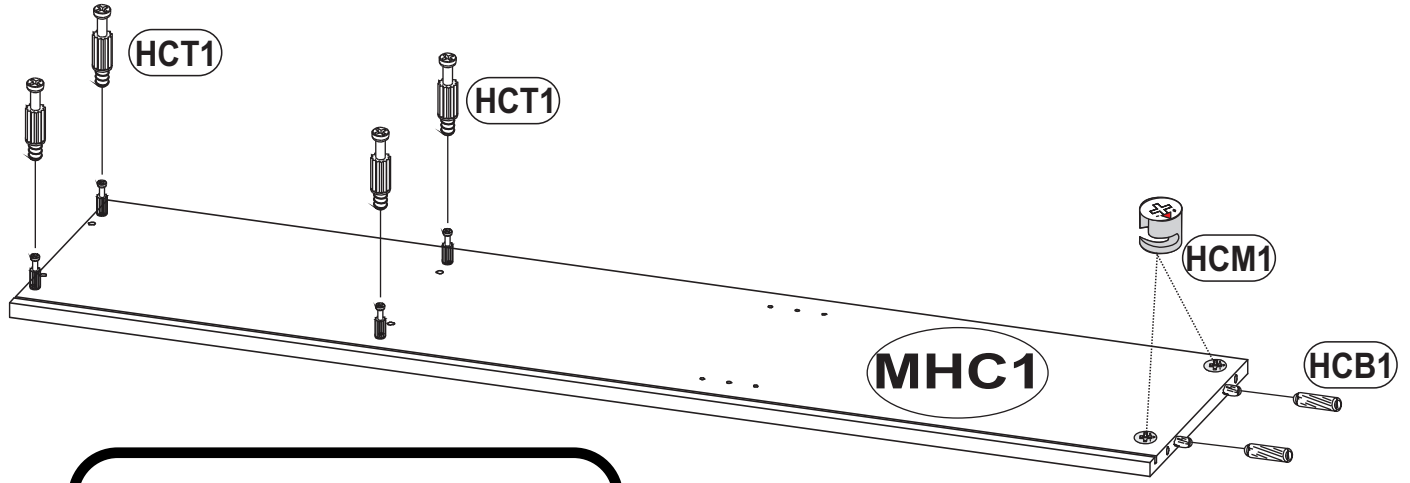

5

OPTION L

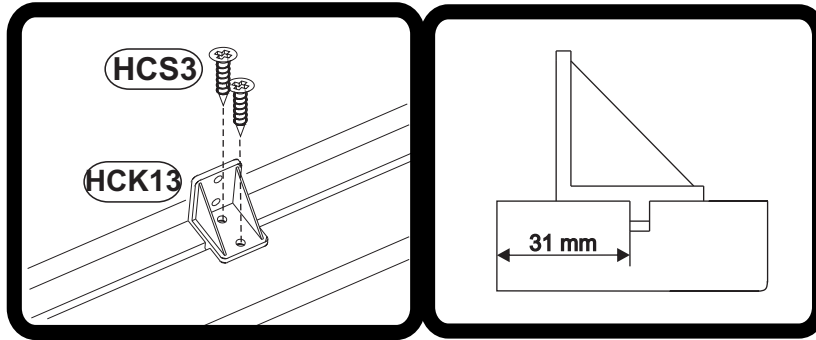
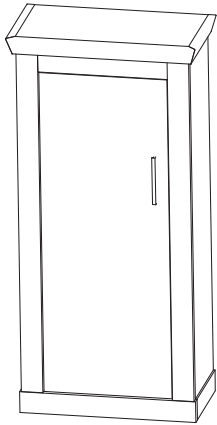

HCS3		1011
	3,5x13	x16
HCD14		23515
	H4	x2
HCK13		49716
		x8

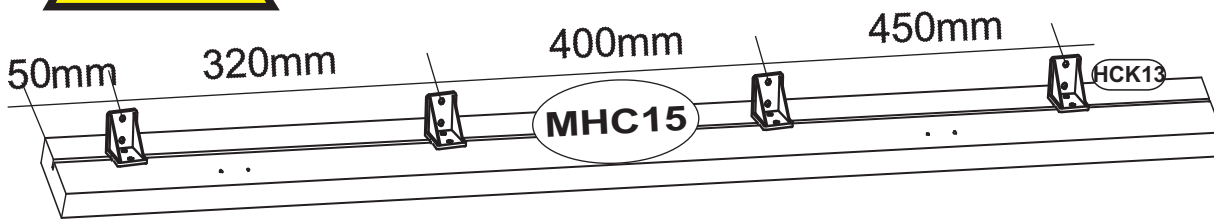
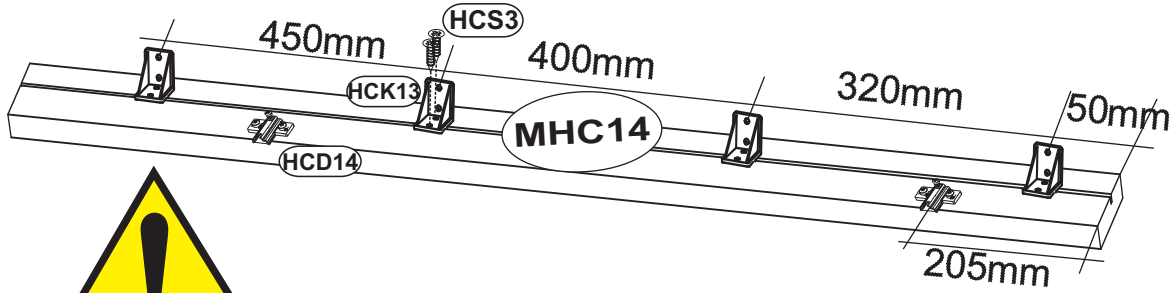
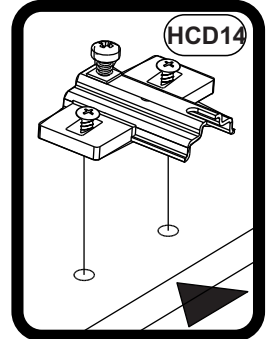



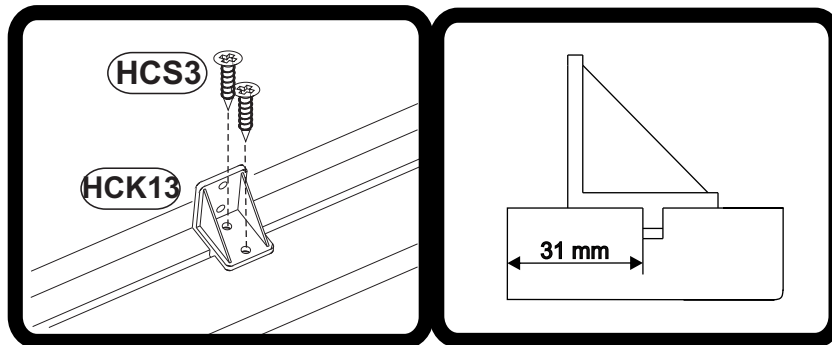
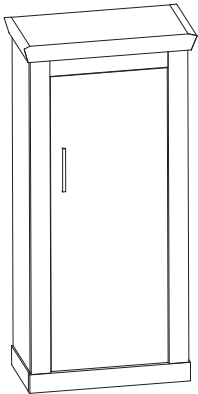

OPTION R

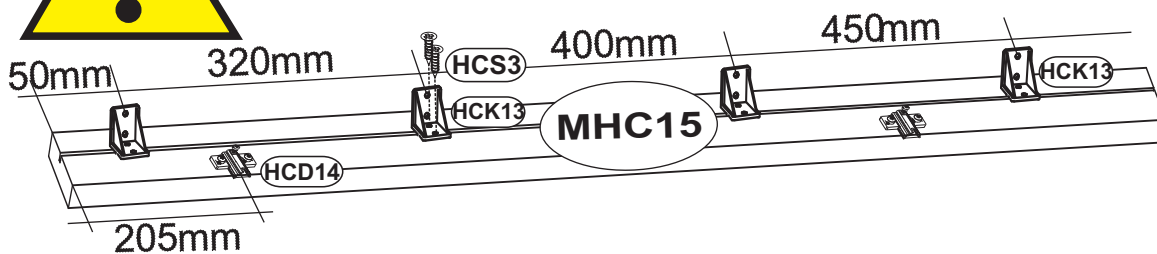
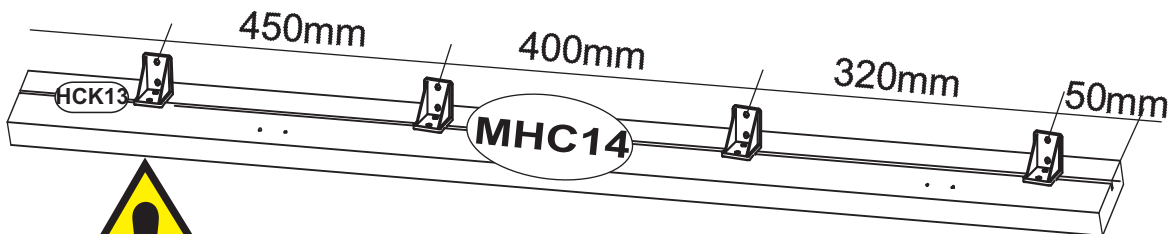
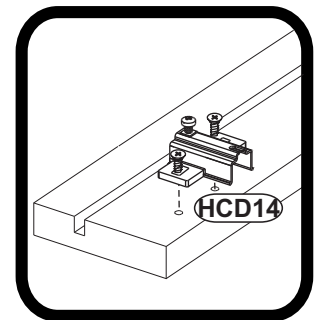

HCS3		1011
	3,5x13	x16
HCD14		23515
	H4	x2
HCK13		49716
		x8



6

HCF14		1021	HCB1		1018
		x2		8x28	x8
HCS3		1011	HCM1		123894
	3,5x13	x4			x8

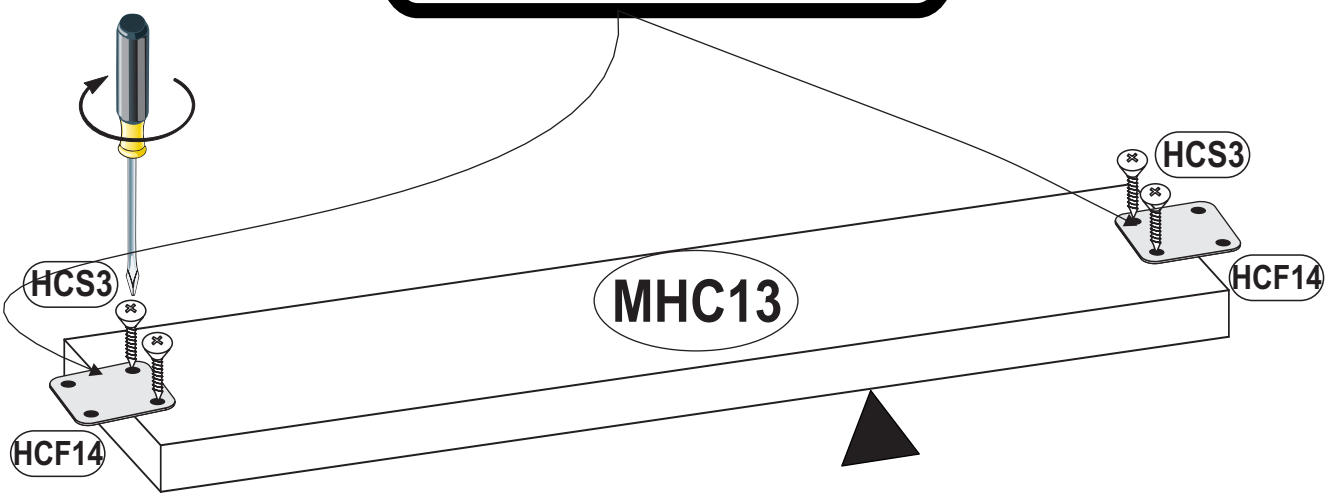
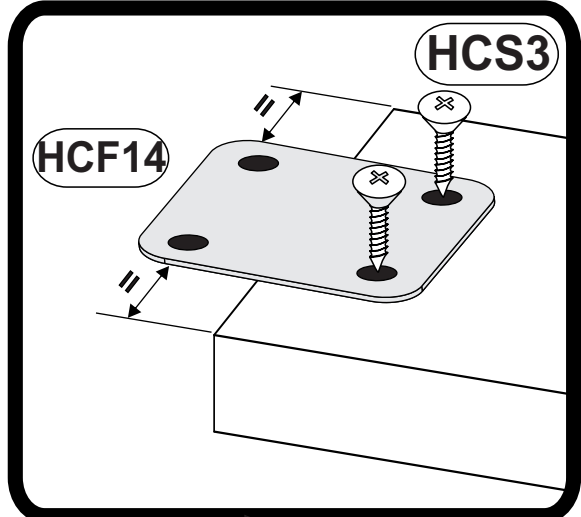
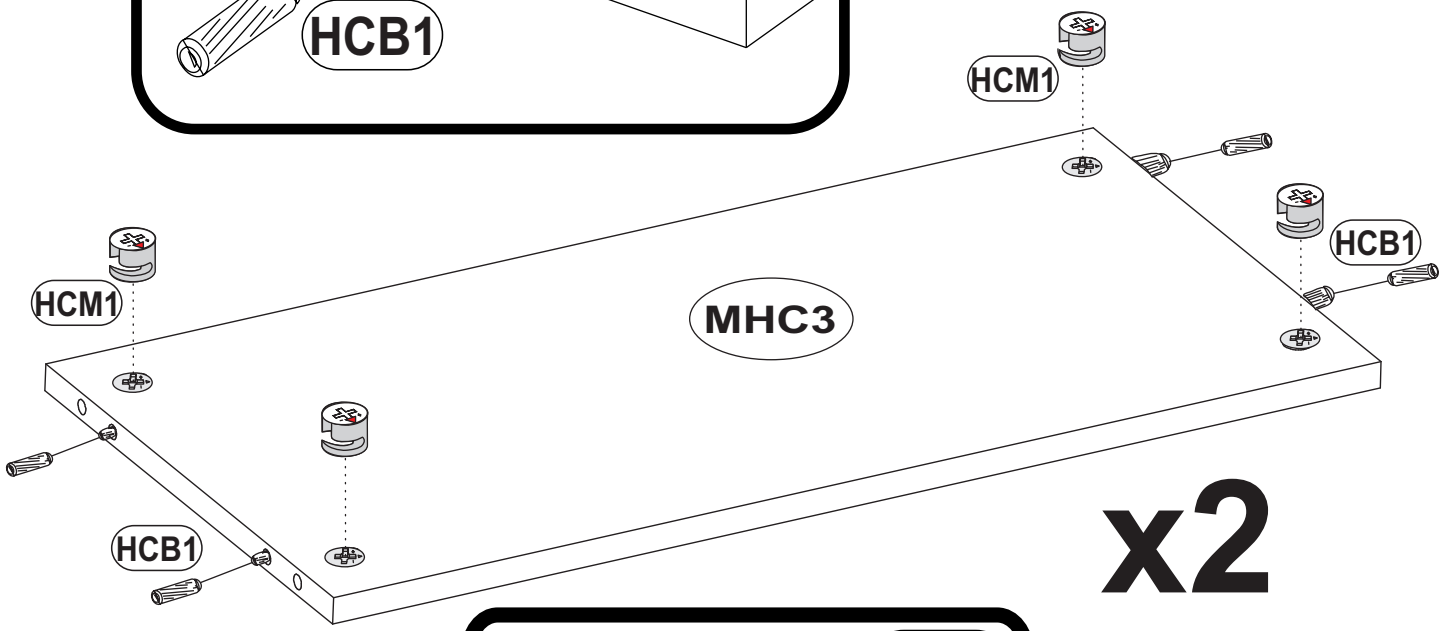
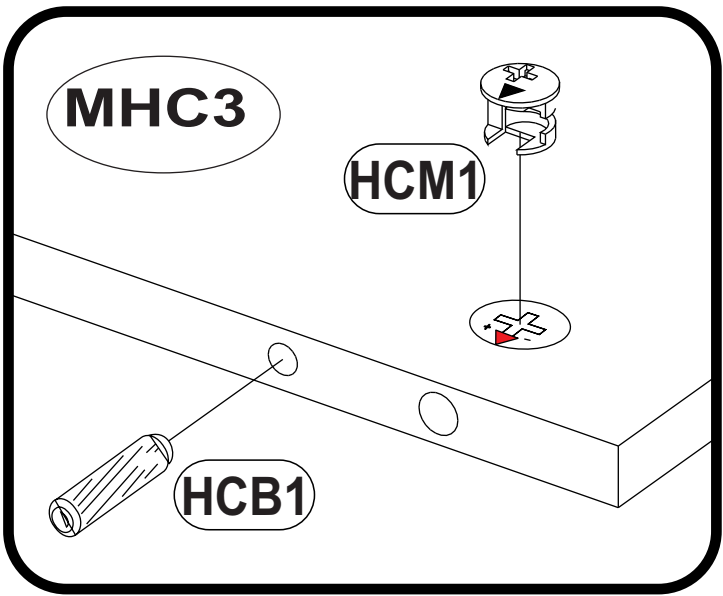



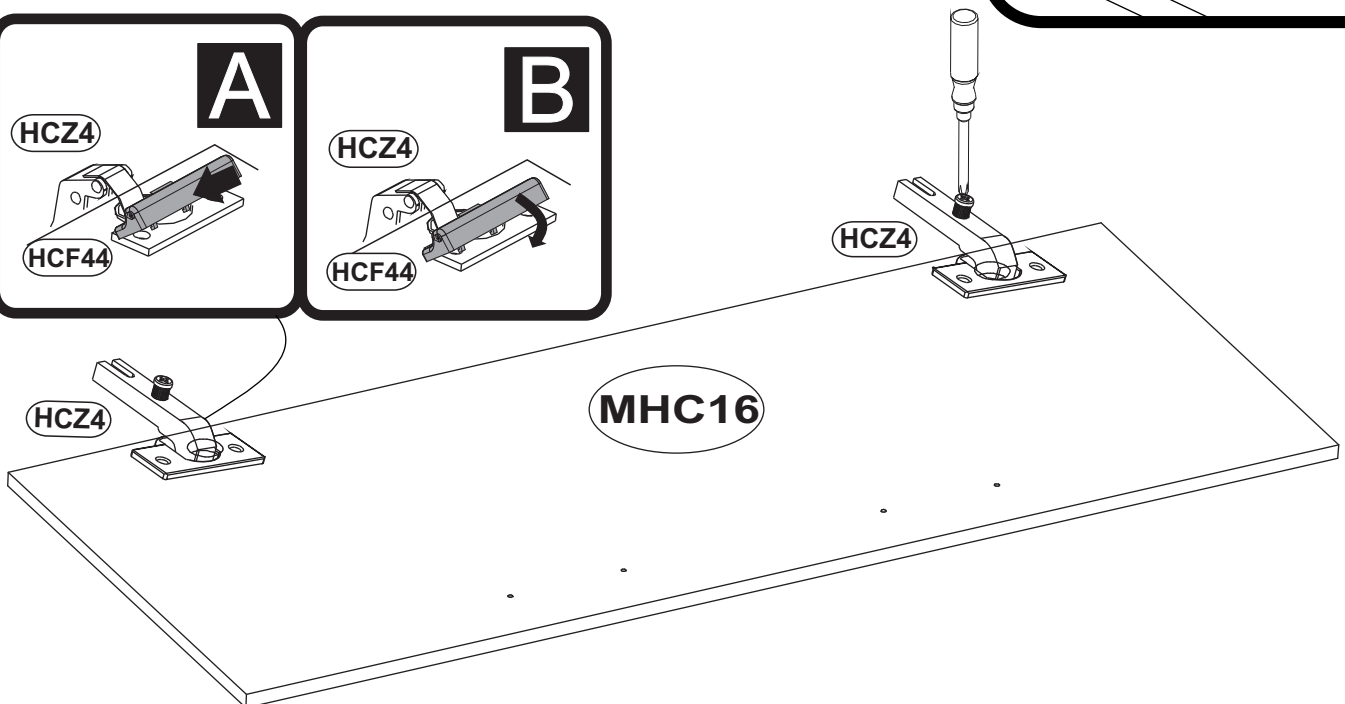
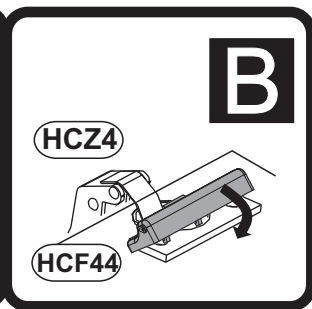
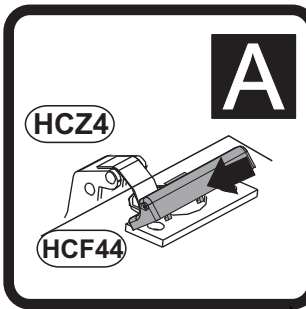
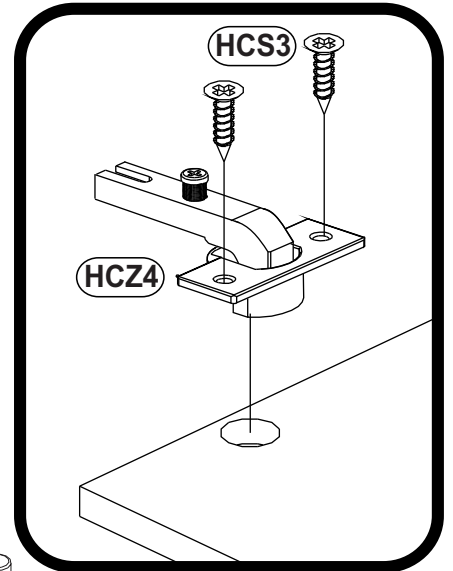
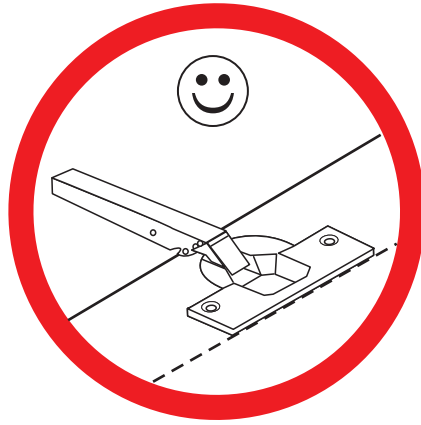
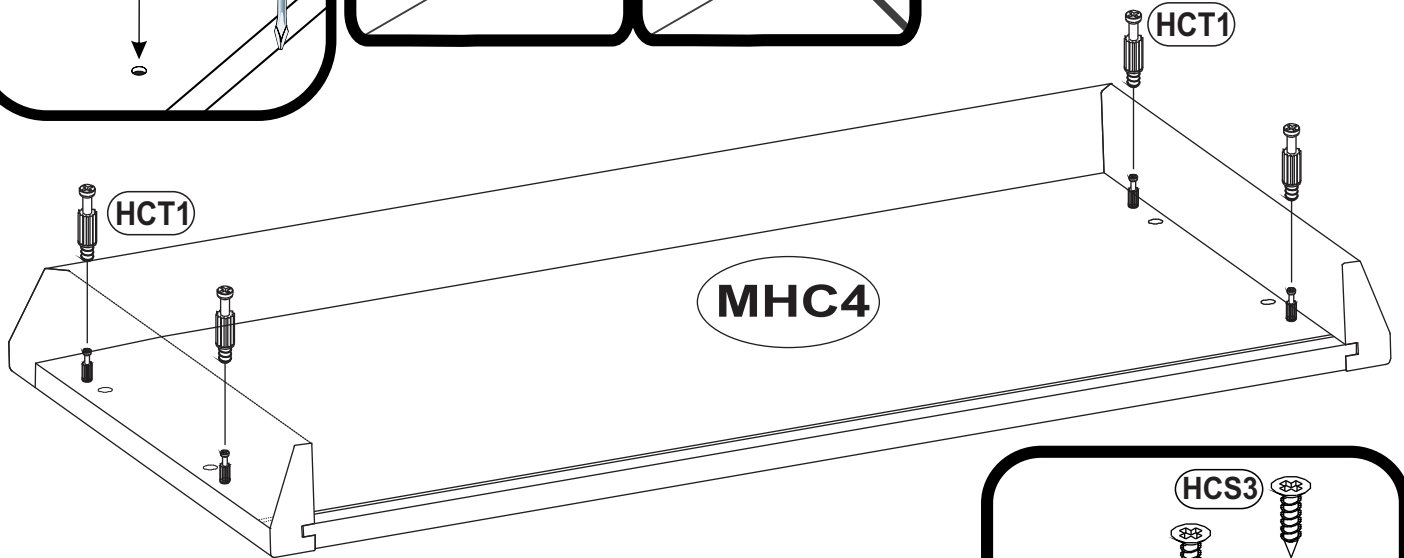
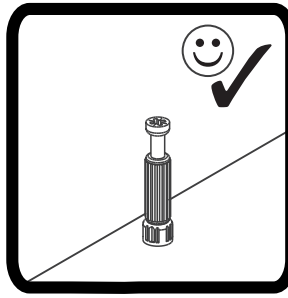
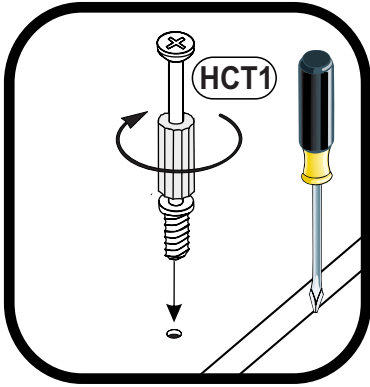
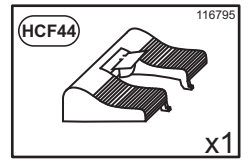
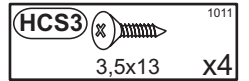
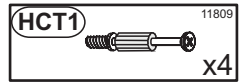
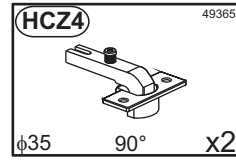

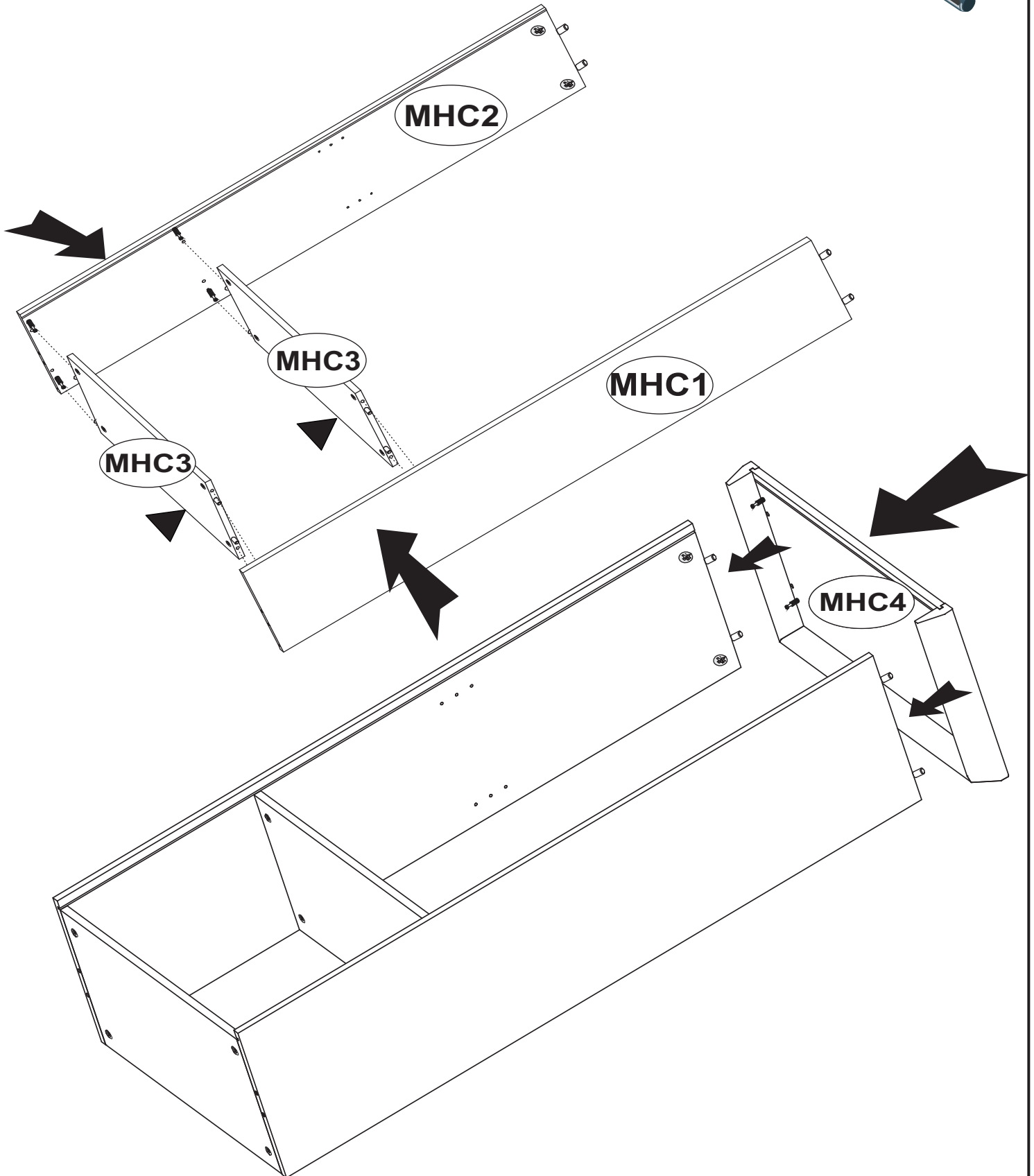
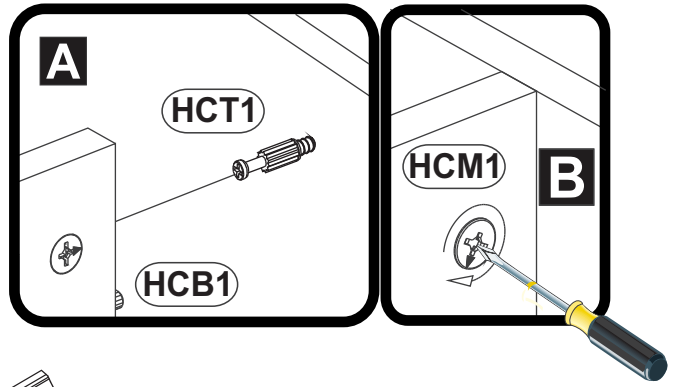
7





9

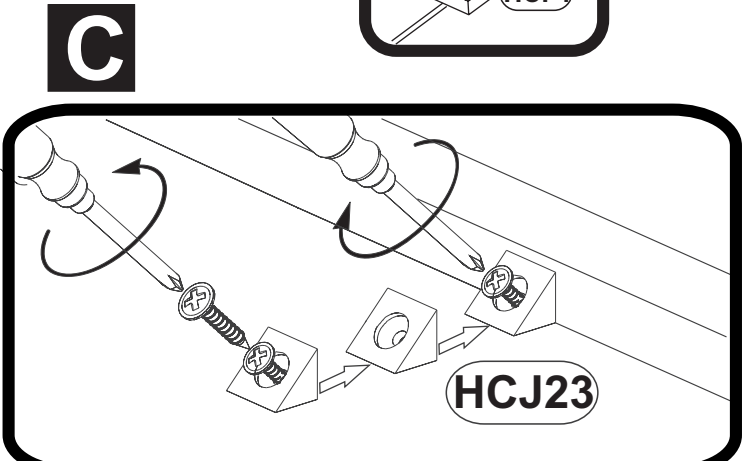
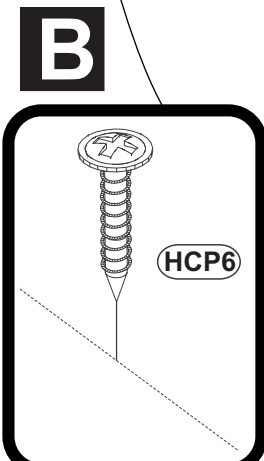
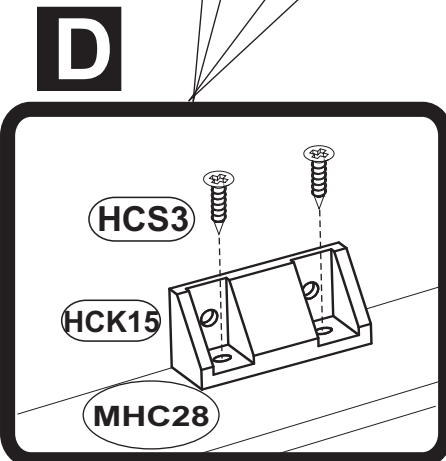
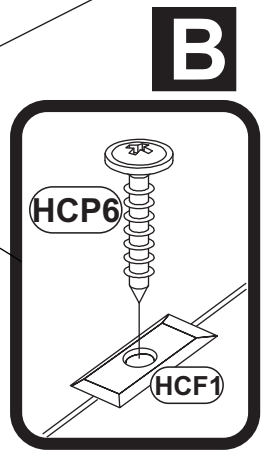
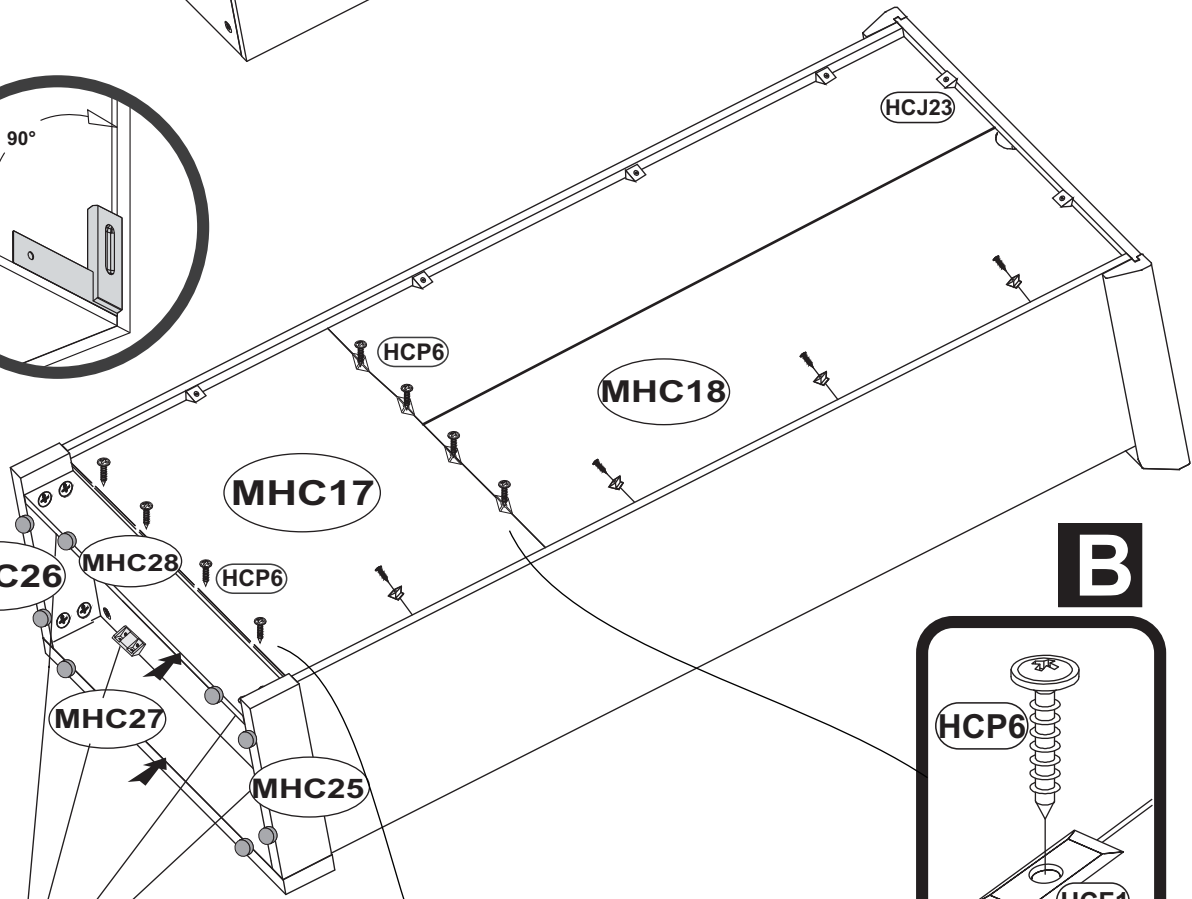
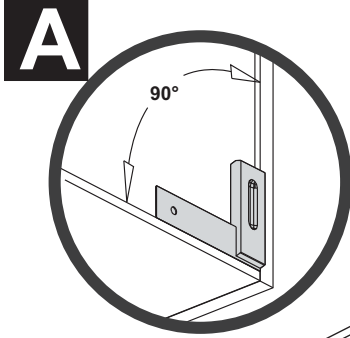
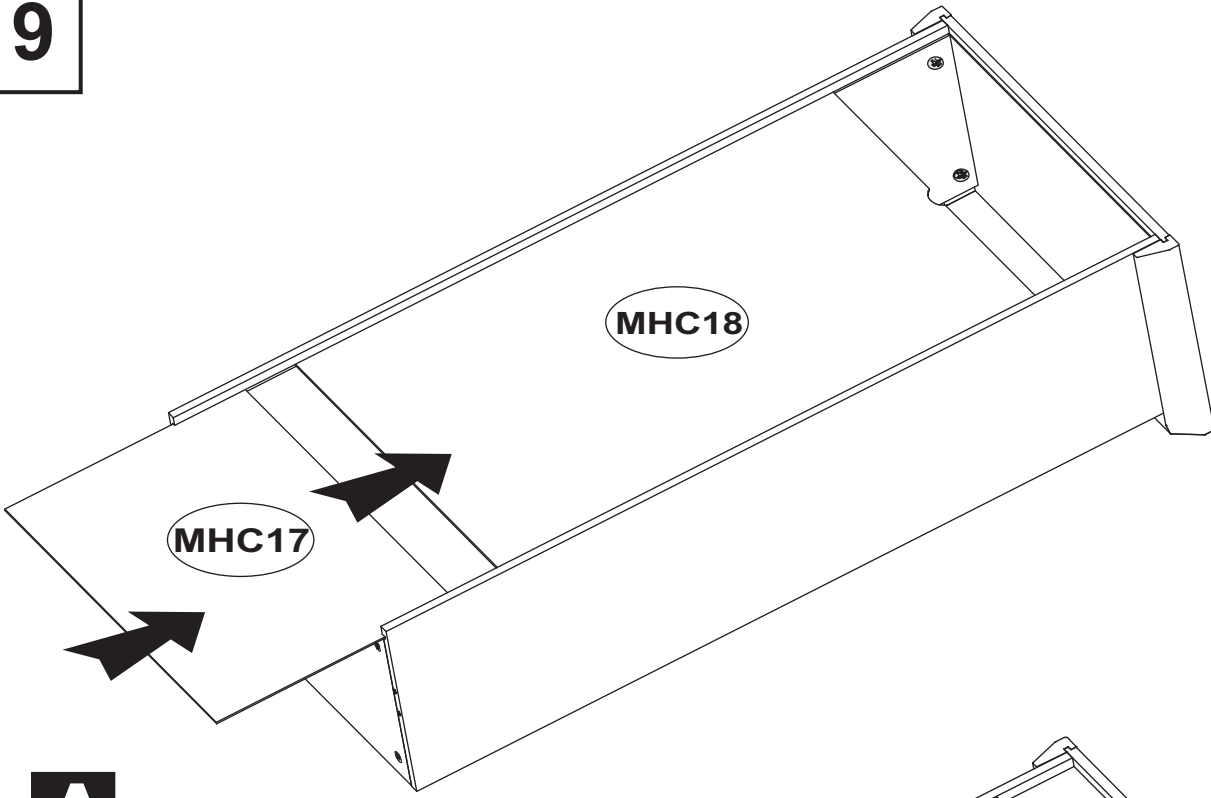

HCS3		1011
	3,5x13	x8
HCP6		1056
	3x20	x8
HCJ23		1302
		x10
HCF1		1415
		x4

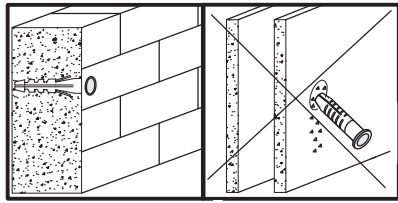
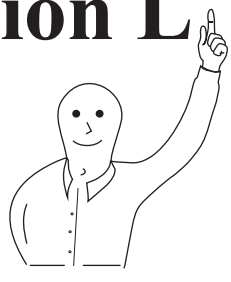

10A

Option L



HCS3 	1011
3,5x13	x20
HCW1 	1289
	x4
HCJ11 	1267
	x1

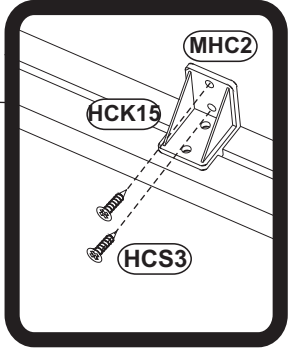
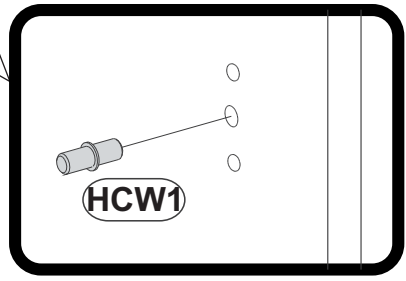
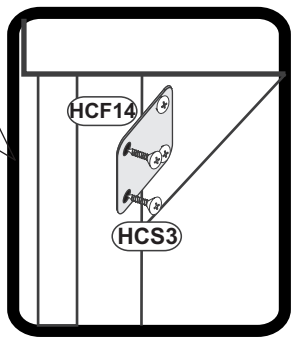
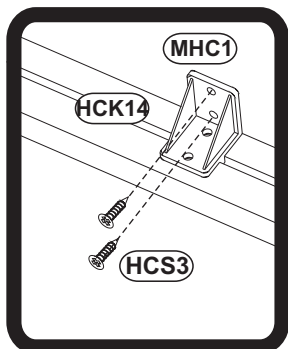
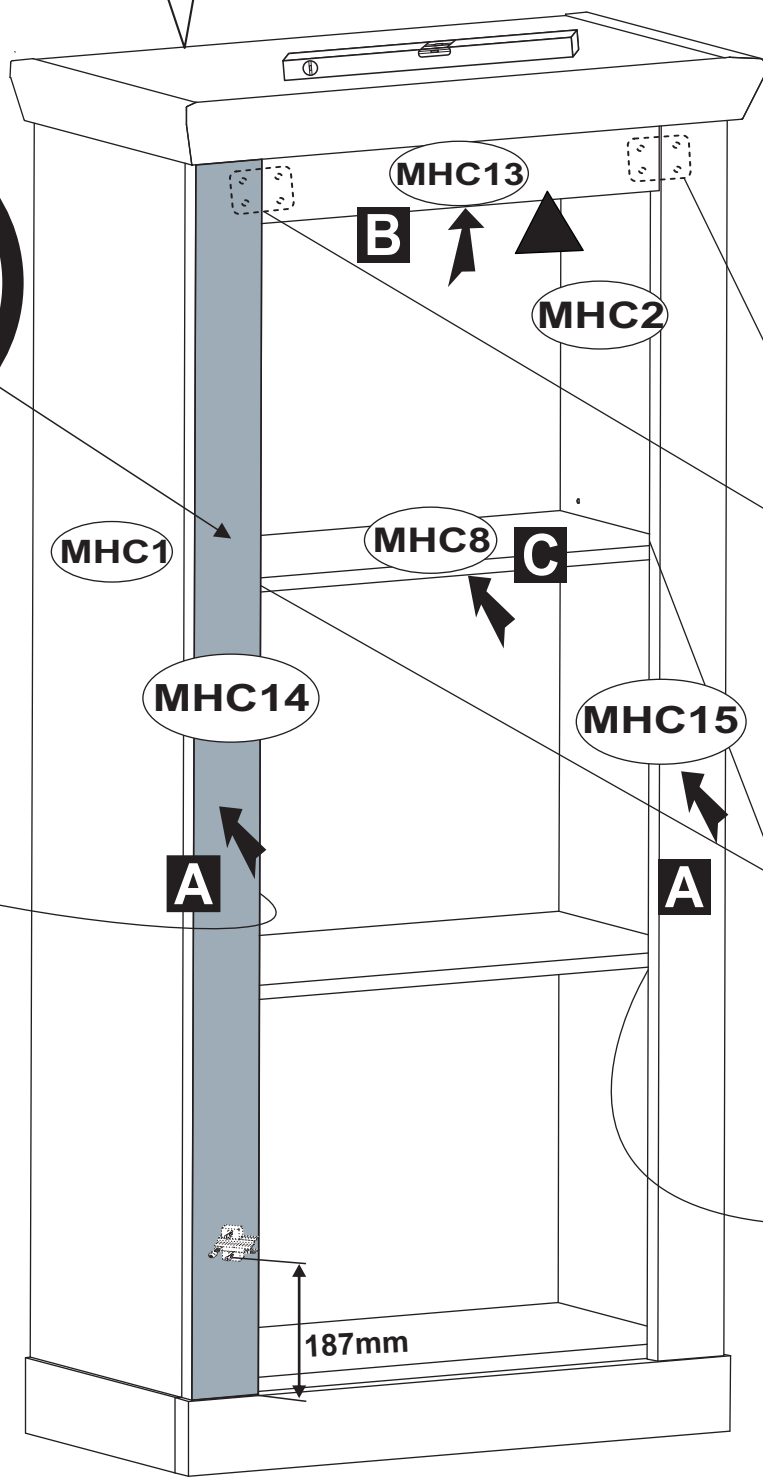
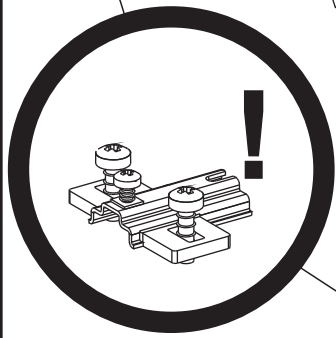
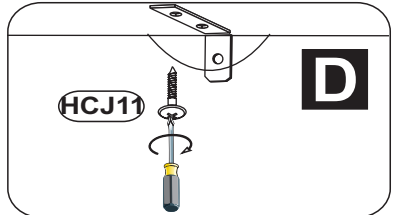
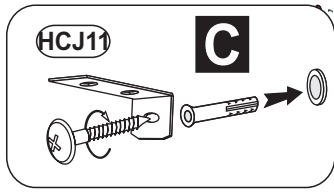
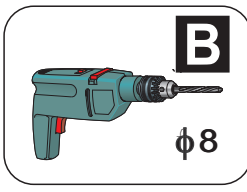
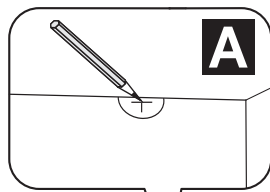

10B

Option R

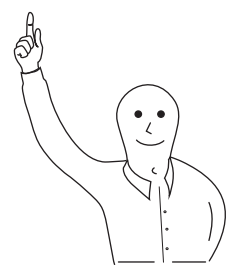
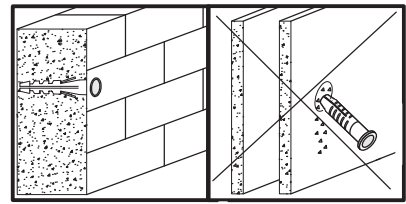



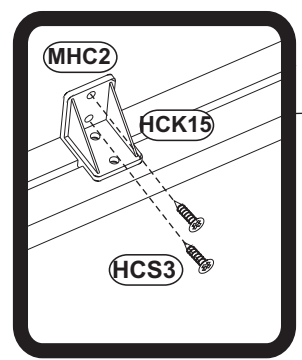
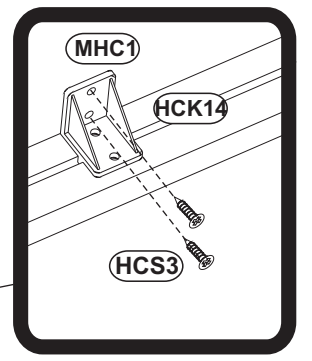
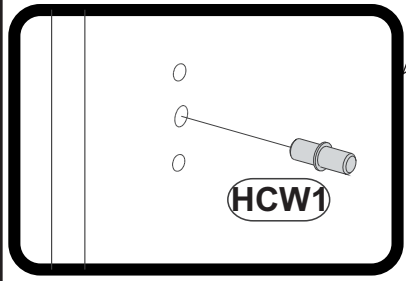
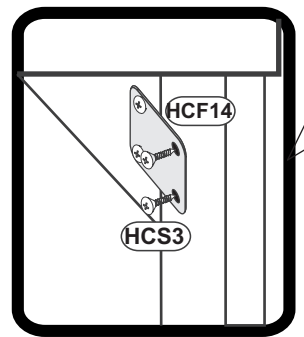
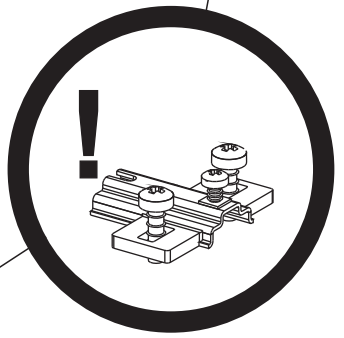
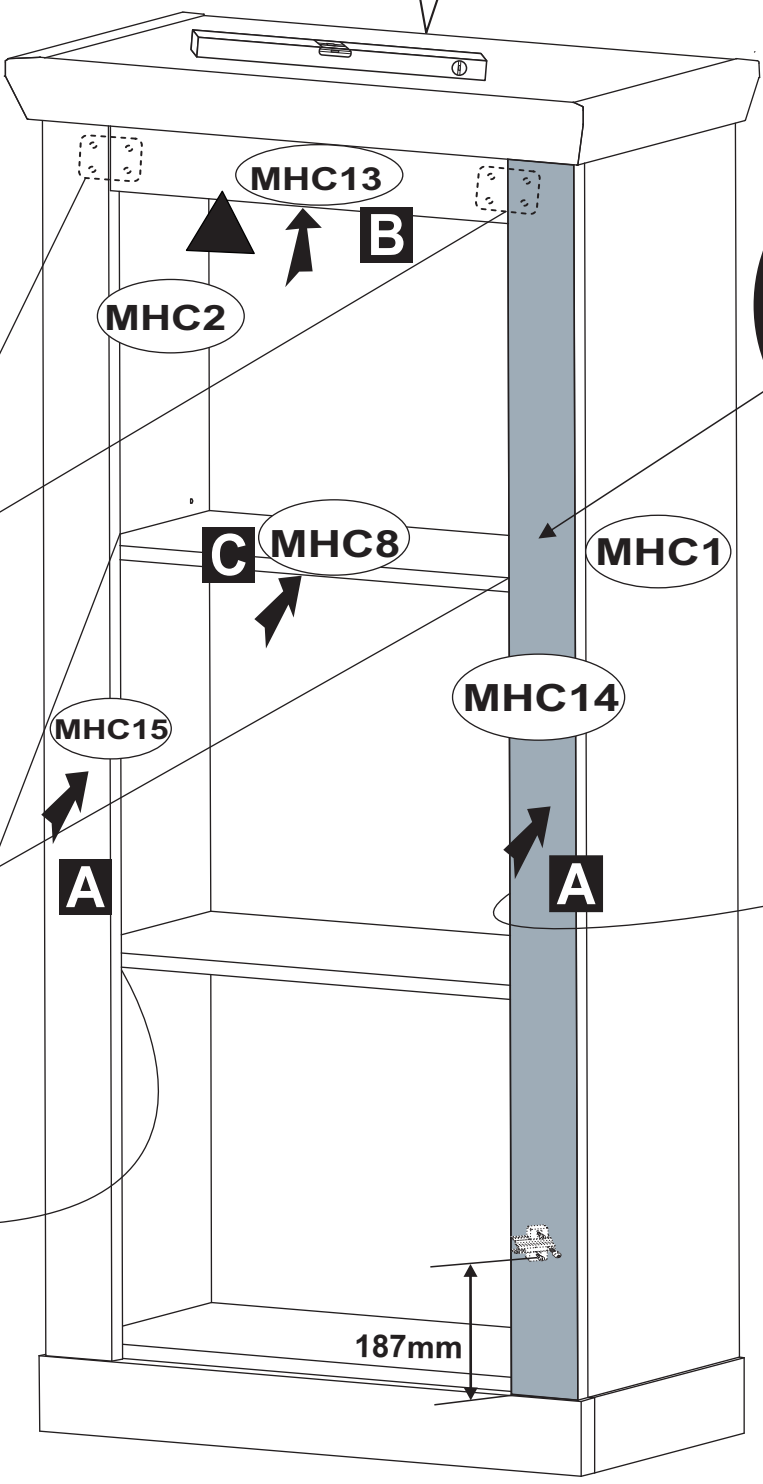
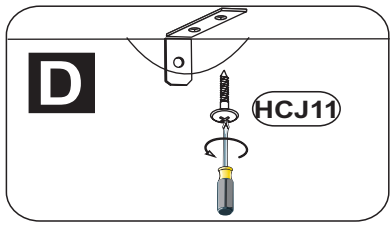
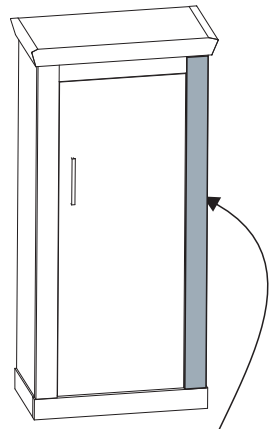
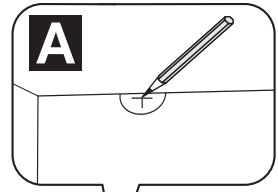
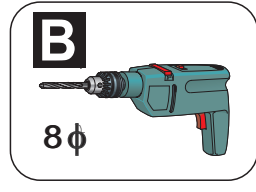
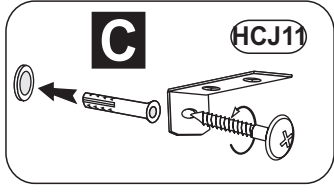

HCS3		1011
	3,5x13	x20
HCW1		1289
		x4
HCJ11		1267
		x1



11

OPTION L

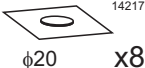
HCU4		133907	x1
HCG54		126680	x1
HCP2		1014	x1
HCA6		2549	x2
HCC6		14217	x8

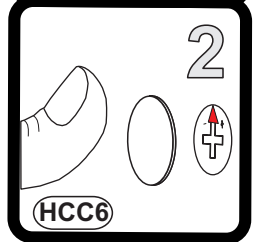
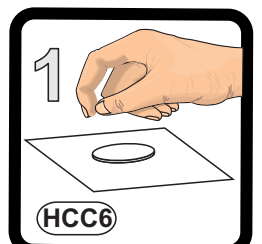
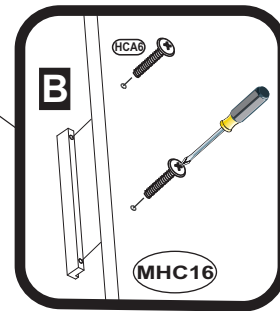
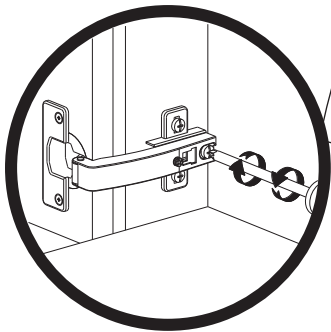
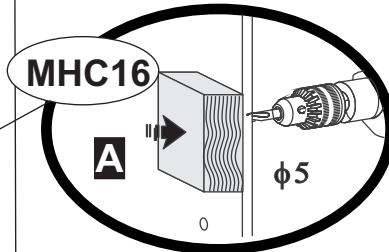
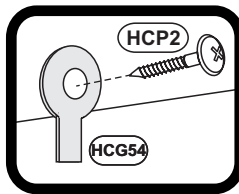
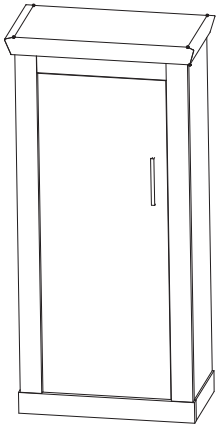

OPTION R

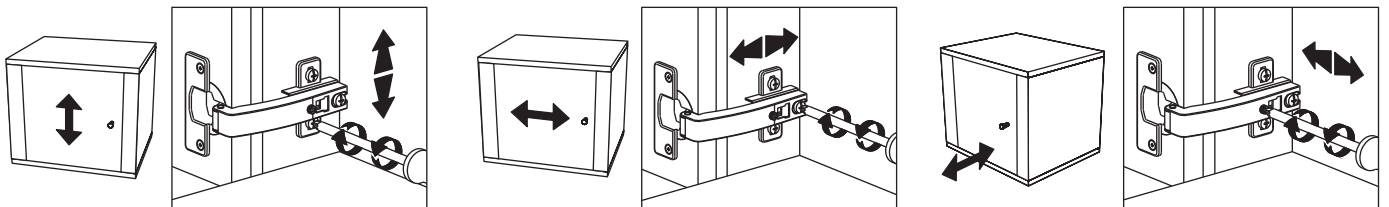
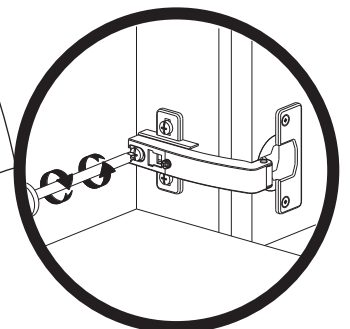
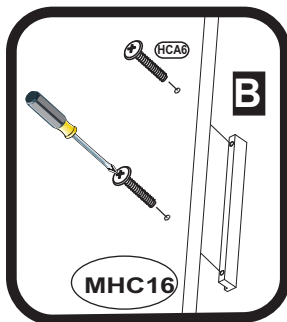
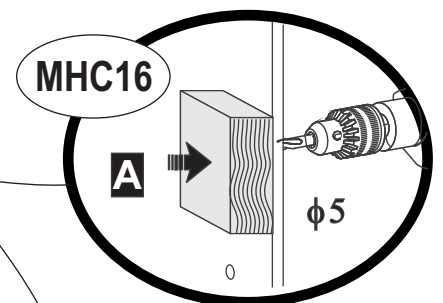
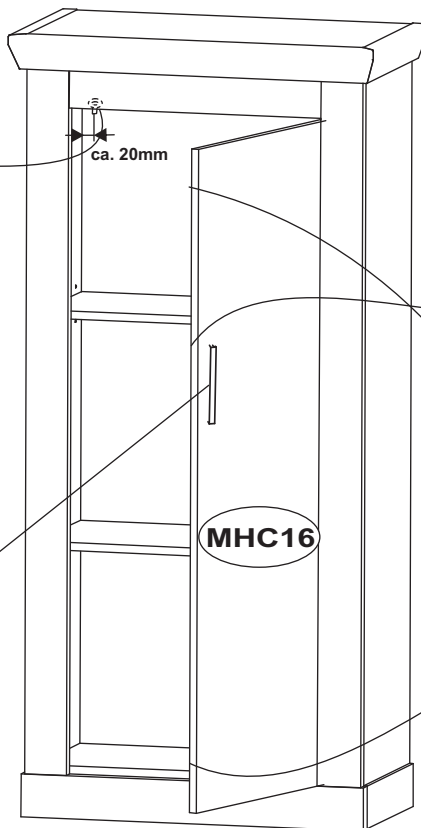
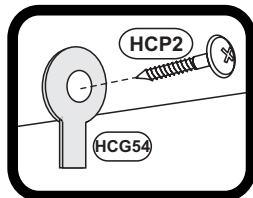
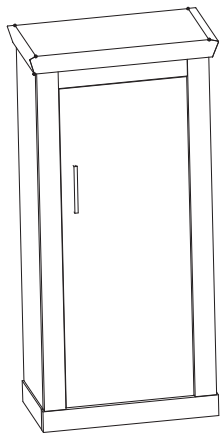

SIENA 41M

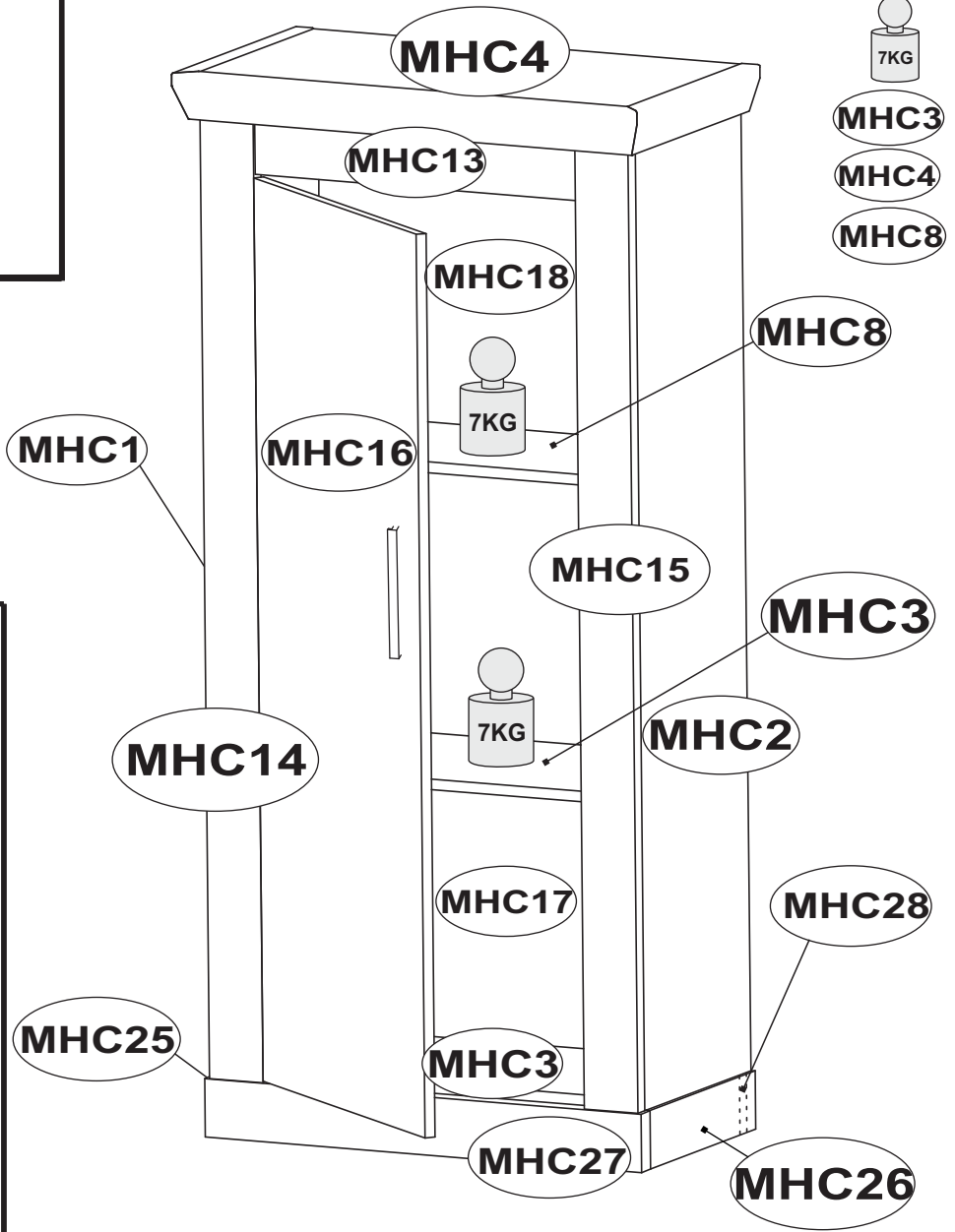
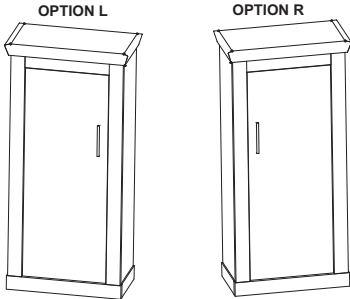

D Unser Direktservice für Beschlagteile
Sollte Ihnen ein Beschlagteil fehlen, können Sie diese Servicekarte direkt an die untenstehende Adresse mailen. Wir können allerdings nur Beschlagteile auf diesem Wege verschicken. Sollten Sie eine andere Beanstandung an Ihrem Möbelstück haben, so wenden Sie sich bitte direkt an Ihr Möbelhaus.

GB Our direct order service for fitting
If a fitting part is missing, you can e-mail this service card directly to the address below. However, we can only send fitting parts in this way. If you have any other cause for complaint concerning your item of furniture, please contact your furniture store directly.

CZ Naše přímé služby pro kování
Chybí-li vám nějaký díl z kování, můžete tuto servisní kartu odeslat e-mailem přímo na níže uvedenou adresu. Touto cestou však můžeme zoslat jen díly kování. Pokud byste reklamovali jiný díl nábytku, obraťte se přímo na svého prodejce nábytku.

F Bien étudier la notice de montage
S'il vous manque une ferrure, veuillez envoyer directement la présente carte service à l'adresse e-mail indiquée ci-dessous. Cependant, ceci nous permet uniquement d'envoyer des ferrures. Pour tout autre type de réclamation concernant votre meuble, veuillez contacter directement votre magasin d'ameublement.

I Il nostro servizio diretto per l'ordine della ferramenta
Qualora Vi dovesse mancare un pezzo di fissaggio, allora Vi preghiamo di inviare questa carta di servizio immediatamente all'indirizzo sottostante. Possiamo inviare i pezzi di fissaggio solamente per mezzo di questo procedimento. Qualora doveste avere qualche altra reclamazione in merito al mobile, allora Vi preghiamo di rivolgerVi direttamente al Vostro Negozio di mobili.

BG Нашата директна услуга за обкове
Ако липсват части от комплекта, попълнете настоящата сервисна карта и ни я изпратете на e-mail адреса, посочен по-долу. По този начин можем да доставяме само липсващи елементи от обкова. Ако установите други дефекти по мебелите, Ви съветваме да се обвържете към мебелната къща/магазин, от който сте закупили стоката.

NL Onze directservice voor losse onderdelen
Wanneer er een onderdeel ontbreekt, kunt u deze servicekaart direct aan onderstaand e-mailadres sturen. Wij kunnen langs deze weg echter alleen beslagdelen versturen. Mocht u een ander probleem aan uw meubel hebben, verzoeken wij u contact op te nemen met uw meubeldealer.

PL Nasz bezpośredni serwis czeski montażowy
Jeżeli brakuje części koniecznych do montażu, prosimy o przesłanie nam niniejszej karty serwisowej na niżej podany adres e-mailowy. W ten sposób możemy przelać Państwu tylko brakujące części. W przypadku innych reklamacji dotyczących mebla, prosimy zgłosić się do salonu meblowego, w którym został dokonany zakup.

HR Servis za okove
U slučaju da nedostaje neki od dijelova molimo vas da na dolje navedenu mail adresu pošaljete ovaj servisni obrazac. Na ovaj način mogu se dostaviti samo okovi. U slučaju da imate dodatne prigovore vezane uz komad namještaja molimo vas da se obratite izravno trgovini namještaja gdje je isti kupljen.

HU Direktszoqlátatunk vasalatok esetén
Ha hiányzik egy vasalat, ezt a kártyát közvetlenül elküldheti az alább található címre. Azonban csak a vasalatoikat tudunk így küldeni. Amennyiben másfajta reklamációt áll fenn bútorárbaját illetően, forduljon közvetlenül a bútorházhoz.

SK Naše priamy servis pro častí kovania
Ak by Vám chýbala nejaká časť kovania, môžete poslať túto servisnú kartu poslať e-mailom na nižšie uvedenú adresu. Diely kovania vieme poslať iba týmto spôsobom. Ak by ste mali inú reklamáciu ohľadom Vašho nábytku, obraťte sa priamo na Vašu predajňu nábytku.

SLO Naše direktne uslužne storitve za okovje
Če vam manjka kakšno okovje, lahko to servisno kartico pošljete po e-pošti direktno na spodnji naslov. Po tej poti vam lahko pošljemo samo okovje. Če želite reklamirati kakšen drug del pohištva, se obrnite neposredno na vašo trgovino pohištva.

RO Serviciul nostru direct pentru feronerie
În cazul în care vă lipsește o piesă de feronerie puteți să trimiteți direct acest card de service prin e-mail la adresa de mai jos. Noi nu putem expedia piese de feronerie decât pe această cale. Dacă aveți o altă reclamație referitoare la piesa de mobilier, atunci vă rugăm să vă adresați direct la magazinul dvs. de mobilier.

RUS Наш прямой сервис для поставок фурнитуры
Если окажется, что Вам не хватает того или иного элемента фурнитуры, Вы можете отправить сервисную карту по факсу непосредственно на нижеприведенный адрес электронной почты. Однако, таким образом мы можем переслать лишь фурнитуру. Если же у Вас возникнут иные претензии относительно приобретенной мебели, пожалуйста, обращайтесь непосредственно в организацию, осуществлявшую продажу.

S Vir direktservice för beslagsdelar
Om du saknar en beslagsdel kan du skicka detta servicekort direkt till e-postadressen som anges nedan. Tänk på att detta är den enda möjligheten att skicka beslagsdelar till dig. Om du vill reklamera din möbel av en annan anledning måste du kontakta ditt möbelhus direkt.

ES Nuestro servicio directo para accesorios
Si le falta algún accesorio, puede enviar esta tarjeta de servicio directamente a la siguiente dirección. No obstante, por esta método solo podemos enviar accesorios. Si tiene alguna otra objeción sobre su mueble, consulte directamente con su mueblería.

TR Donatılar için doğrudan servisimiz
Bir donatınız eksikse bu servis kartını doğrudan aşağıda bulunan adrese doğrudan mail yazabilirsiniz. Sadece bu yöle donatıları gönderebilirsiniz. Mobilyanızda başka şikayetleriniz varsa lütfen doğrudan mobilya satıcınıza danışın.

MHC1	x1	1361	320	15	1/1
MHC2	x1	1361	320	15	1/1
MHC3	x2	611	299	15	1/1
MHC4	x1	705	373	65	1/1
MHC8	x1	610	267	15	1/1
MHC13	x1	483	124	18	1/1
MHC14	x1	1361	80	22	1/1
MHC15	x1	1361	80	22	1/1

MHC16	x1	1231	477	15	1/1
MHC17	x1	421	623	3	1/1
MHC18	x1	945	623	3	1/1
MHC25	x1	313	80	32	1/1
MHC26	x1	313	80	32	1/1
MHC27	x1	655	80	32	1/1
MHC28	x1	590	80	15	1/1

SIENA 41M

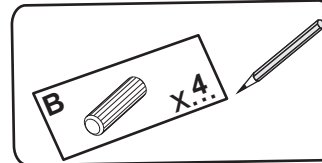
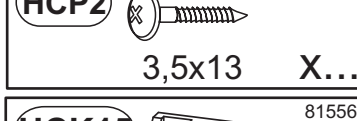
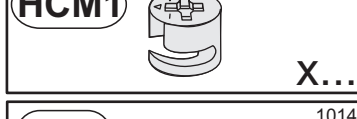
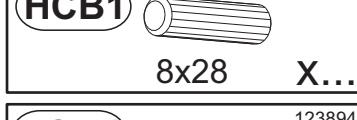
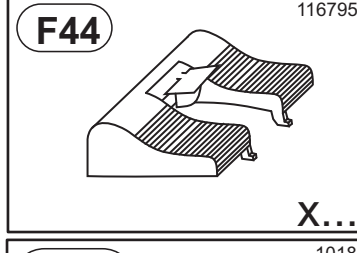
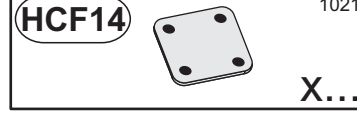
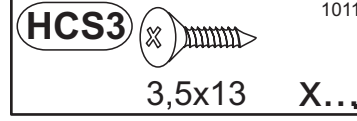
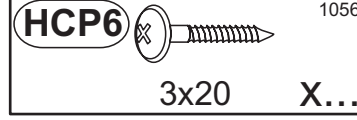
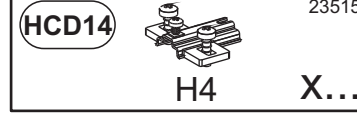
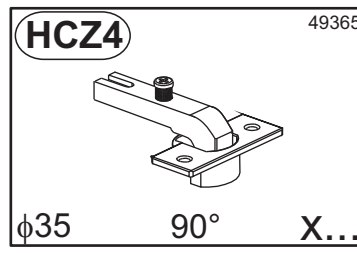
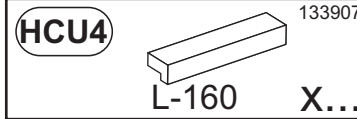
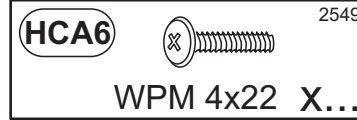
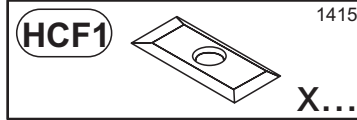
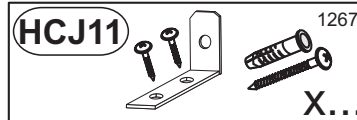
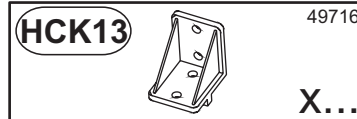
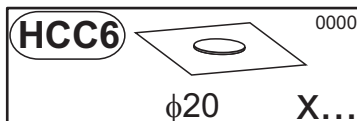
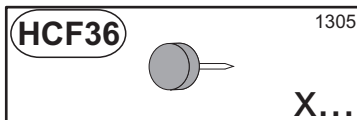
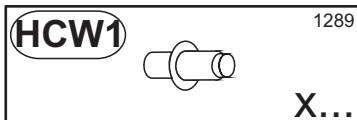
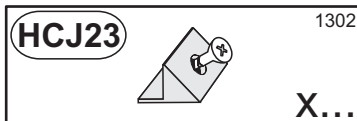
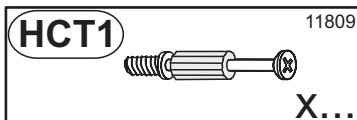

D Unser Direktservice für Beschlagteile
Sollte Ihnen ein Beschlagteil fehlen, können Sie diese Servicekarte direkt an die untenstehende Adresse mailen. Wir können allerdings nur Beschlagteile auf diesem Wege verschicken. Sollten Sie eine andere Beanstandung an Ihrem Möbelstück haben, so wenden Sie sich bitte direkt an Ihr Möbelhaus.

GB Our direct order service for fitting
If a fitting part is missing, you can e-mail this service card directly to the address below. However, we can only send fitting parts in this way. If you have any other cause for complaint concerning your item of furniture, please contact your furniture store directly.

CZ Naše primé služby pro kování
Chybí-li vám nějaký díl z kování, můžete tuto servisní kartu odeslat e-mailem přímo na níže uvedenou adresu. Touto cestou však můžeme rozesílat jen díly kování. Pokud byste reklamovali jiný díl nábytku, obraťte se přímo na svého prodejce nábytku.

F Bien étudier la notice de montage
S'il vous manque une ferrure, veuillez envoyer directement la présente carte service à l'adresse e-mail indiquée ci-dessous. Cependant, ceci nous permet uniquement d'envoyer des ferrures. Pour tout autre type de réclamation concernant votre meuble, veuillez contacter directement votre magasin d'ameublement.

I Il nostro servizio diretto per l'ordine della ferramenta
Qualora Vi dovesse mancare un pezzo di fissaggio, allora Vi preghiamo di inviare questa carta di servizio immediatamente all'indirizzo sottostante. Possiamo inviare i pezzi di fissaggio solamente per mezzo di questo procedimento. Qualora dovesse avere qualche altra reclamazione in merito al mobile, allora Vi preghiamo di rivolgerVi direttamente al Vostro Negozio di mobili.

BG Нашата директна услуга за обкоя
Ако липсват части от комплекта, попълнете настоящата сервисна карта и ни я изпратете на e-mail адреса, посочен по-долу. По този начин можем да доставяме само липсващи елементи от обкоя. Ако установите други дефекти по мебелите, Ви съветваме да се обърнете към мебелната къща/магазин, от който сте закупили стоката.

NL Onze directservice voor losse onderdelen
Wanneer er een onderdeel ontbreekt, kunt u deze servicekaart direct aan onderstaand e-mailadres sturen. Wij kunnen alleen de weg echter alleen beslagdelen versturen. Mocht u een ander probleem aan uw meubel hebben, verzoeken wij u contact op te nemen met uw meubeldealer.

PL Nasz bezpośredni serwis części montażowych
Jeżeli brakuje części koniecznych do montażu, prosimy o przesłanie nam niniejszej karty serwisowej na niżej podany adres e-mailowy. W ten sposób możemy przesyłać Państwu tylko brakujące części. W przypadku innych reklamacji dotyczących mebla, prosimy zgłosić się do salonu meblowego, w którym został dokonany zakup.

HR Servis za okove
U slučaju da nedostaje neki od dijelova molimo vas da na dolje navedenu mail adresu pošaljete ovaj servisni obrazac. Na ovaj način mogu se dostaviti samo okovi. U slučaju da imate dodatne prigovore vezane uz komad namještaja molimo vas da se obratite izravno trgovini namještaja gdje je isti kupljen.

HU Direktszolgáltatunk vasalatok esetén
Ha hiányzik egy vasalattól, ezt a kártyát közvetlenül elküldheti az alább található címre. Azonban csak vasalattokat tudunk így küldeni. Amennyiben másfajta reklamáció áll fenn bútorárbaját illetően, forduljon közvetlenül a bútorházához.

SK Naš priamy servis pre časti kovania
Ak by Vám chýbala nejaká časť kovania, môžete poslať túto servisnú kartu poslať e-mailom na nižšie uvedenú adresu. Diely kovania vieme poslať iba týmto spôsobom. Ak by ste mali inú reklamáciu ohľadom Vášho nábytku, obráťte sa priamo na Vašu predajňu nábytku.

SLO Naše direktne uslužbne storitve za okovje
Ce vam manjka kakšno okovje, lahko to servisno kartico pošljete po e-pošti direktno na spodnji naslov. Po tej poti vam lahko pošljemo samo okovje. Ce želite reklamirati kakšen drug del pohištva, se obrnite neposredno na vašo trgovino pohištva.

RO Service-ul nostru direct pentru feronerie
In cazul in care va lipseste o piesa de feronerie puteti sa trimiteți direct acest card de service prin e-mail la adresa de mai jos. Noi nu putem expedia piese de feronerie decât pe această cale. Dacă aveți o altă reclamație referitoare la piesa de mobilier, atunci vă rugăm să vă adresați direct la magazinul dvs. de mobilă.

RUS Наш прямой сервис для поставок фурнитуры
Если окажется, что Вам не хватает того или иного элемента фурнитуры, Вы можете отправить сервисную карту по факсу непосредственно на нижеприведенный адрес электронной почты. Однако, таким образом мы можем пересылать лишь фурнитуру. Если же у Вас возникнут иные претензии относительно приобретенной мебели, пожалуйста, обращайтесь непосредственно в организацию, осуществившую продажу.

S Vir direktservice för beslagsdelar
Om du saknar en beslagsdel kan du skicka detta servicekort direkt till e-postadressen som anges nedan. Tänk på att detta är den enda möjligheten att skicka beslagsdelar till dig. Om du vill reklamera din möbel av en annan anledning måste du kontakta ditt möbelför direkt.

ES Nuestro servicio directo para accesorios
Si le falta algún accesorio, puede enviar esta tarjeta de servicio directamente a la siguiente dirección. No obstante, por este método solo podemos enviar accesorios. Si tiene alguna otra objeción sobre su mueble, consulte directamente con su mueblería.

TR Donatılar için doğrudan servisimiz
Bir donatınız eksikse bu servis kartını doğrudan aşığada bulunan adrese doğrudan mail yazabilirsiniz. Sadece bu yolla donatıları gönderebilirsiniz. Mobilyanızda başka şikayetleriniz varsa lütfen doğrudan mobilya satıcınıza danışın.