

Soul

8141/2500/5010/1073
1071/5010/2500/8142

- | | | | |
|-----------|--|-----------|---|
| D | MONTAGEANLEITUNG
BEDIENUNGSANLEITUNG | GB | ASSEMBLY INSTRUCTIONS
INSTRUCTION MANUAL |
| NL | HANDLEIDING VOOR DE MONTAGE
GEBRUIKSAANWIJZING | PL | INSTRUKCJA MONTAŻU
INSTRUKCJA OBSŁUGI |
| TR | MONTAJ TALIMATI
KULLANIM KLAVUZU | RU | ИНСТРУКЦИЯ ПО МОНТАЖУ
ИНСТРУКЦИЯ ПО ЭКСПЛУАТАЦИИ |
| RO | INSTRUCȚIUNI DE INSTALARE
INSTRUCȚIUNI DE UTILIZARE | IT | ISTRUZIONI DI MONTAGGIO
MANUALE DI ISTRUZIONI |
| FR | NOTICE DE MONTAGE
MANUEL INSTRUCTIONS | SK | MONTÁŽNY NÁVOD
NÁVOD NA POUŽITIE |
| HU | KÖZGYŰLÉS UTASÍTÁSOK
KEZELÉSI UTASÍTÁS | CZ | MONTÁŽNÍ NÁVOD
NÁVOD K POUŽITÍ |
| SI | NAVODILA ZA MONTAŽO
NAVODILA ZA UPORABO | PT | INSTRUÇÕES DE MONTAGEM
MANUAL DO USUÁRIO |
| ES | INSTRUCCIONES DE MONTAJE
MANUAL DEL USUARIO | HR | UPUTE ZA MONTAŽU
UPUTE ZA UPOTREBU |

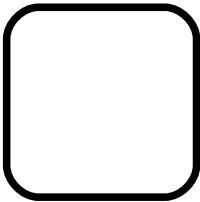
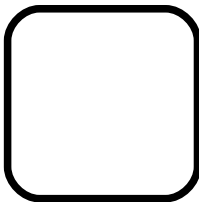

0089

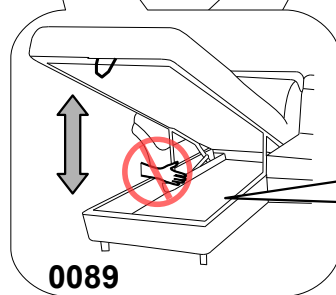
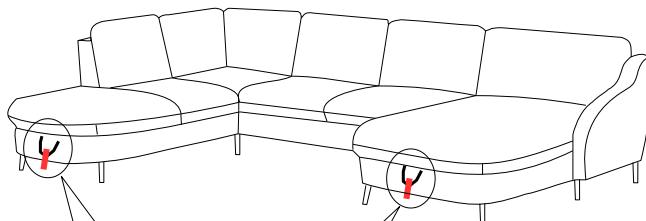
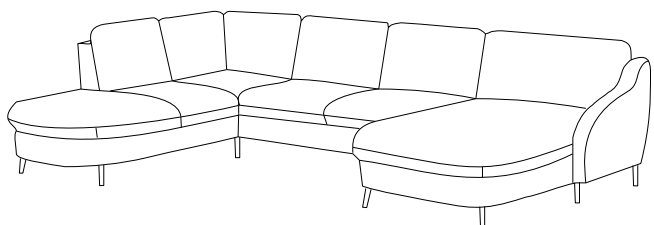
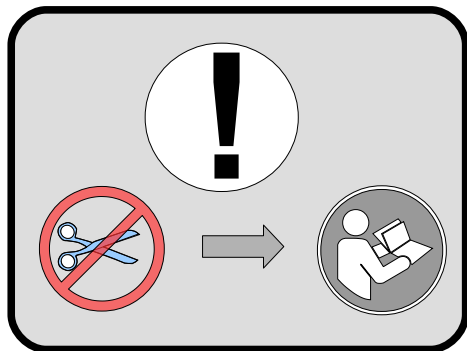

0089

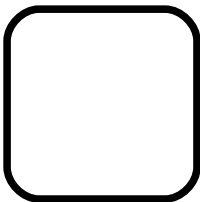
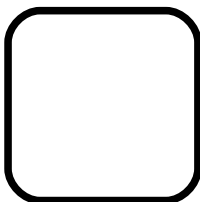

0019

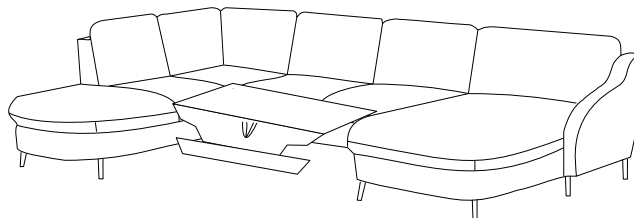
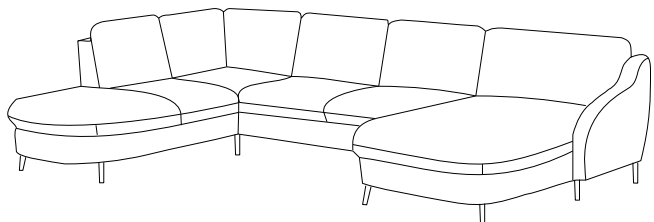

0019

L

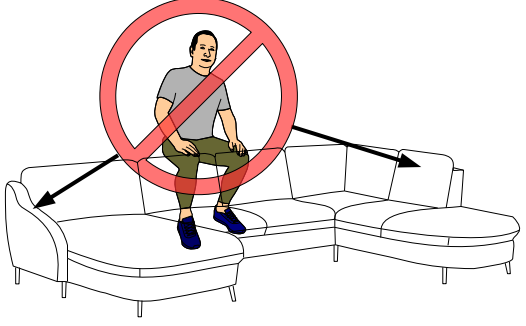

R

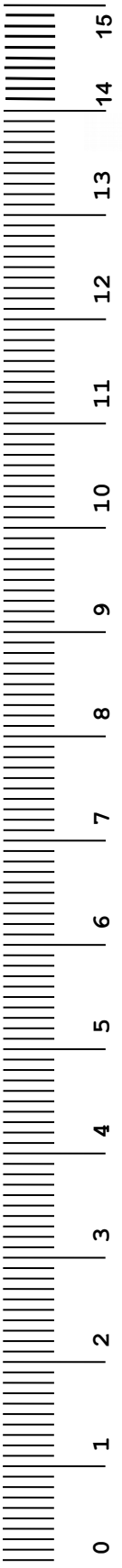
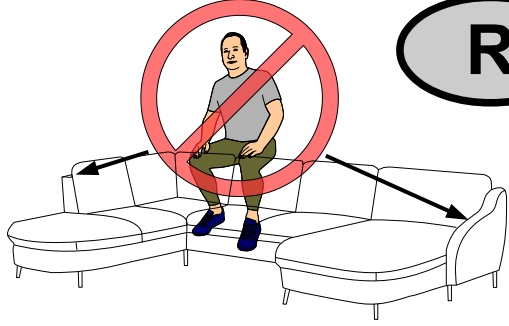

g H-120/150 X1	V H- 120/150 X1	i L- 5 X1	S H- 120/150 s ₁ X4	q M8*35 X8
------------------------------	-------------------------------	-------------------------	---	--------------------------

[mm]

V H- 120/150 X3	i L- 5 X1	S H- 120/150 s ₁ X1	q M8*35 X2
-------------------------------	-------------------------	---	--------------------------

[mm]

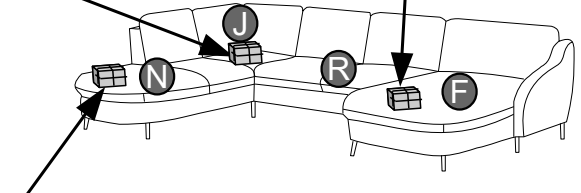
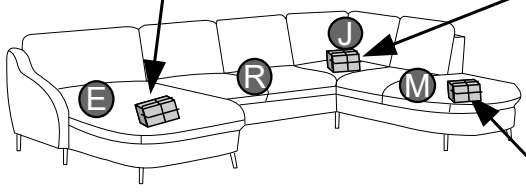



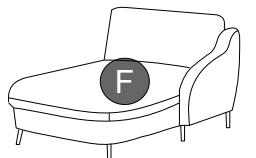
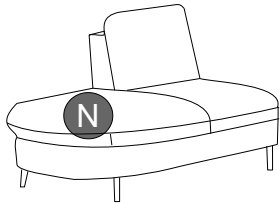
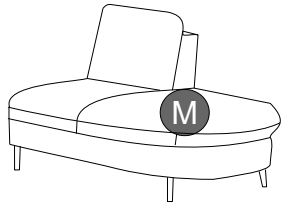
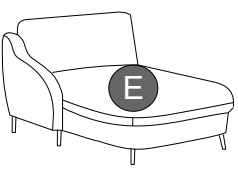
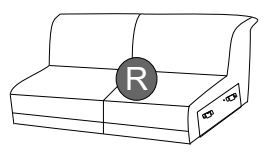
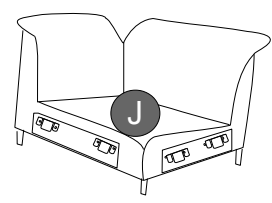
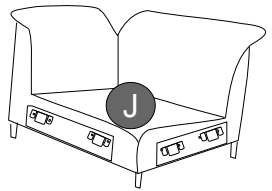
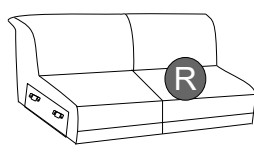

g H-120/150 X2	i L- 5 X1	S H- 120/150 s ₁ X2	q M8*35 X4
------------------------------	-------------------------	---	--------------------------

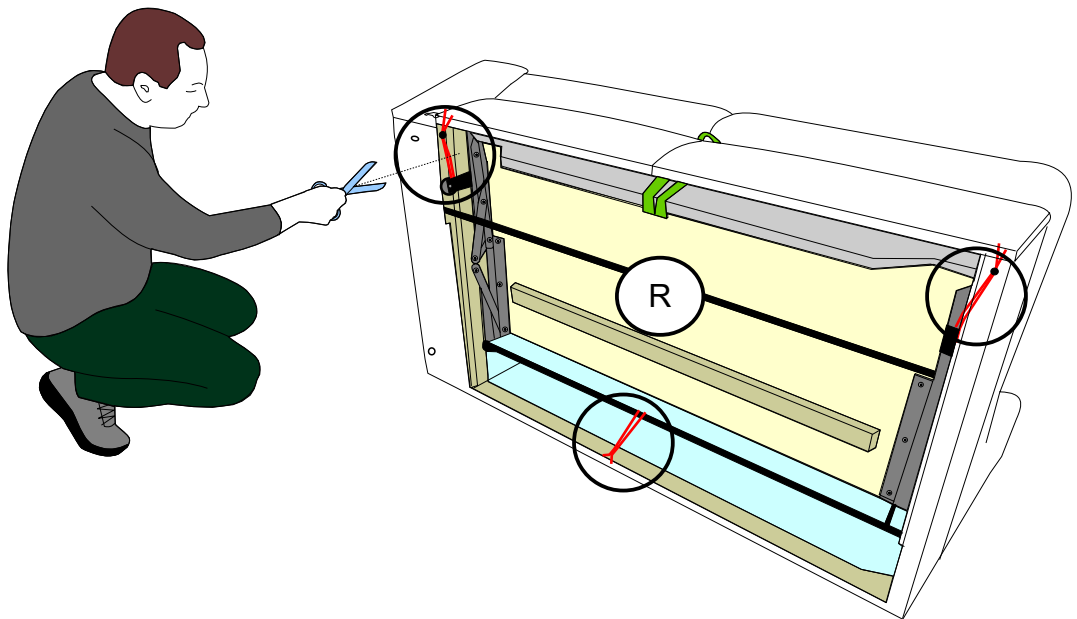
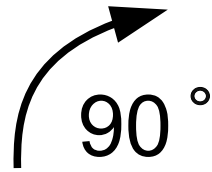
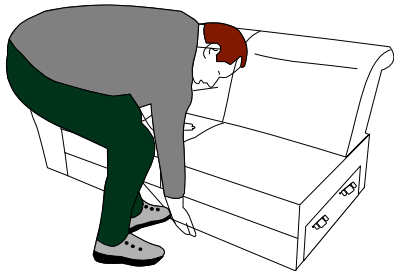
[mm]





0019

g H-120/150  X3	v H- 120/150  X4	i L-5  X1	S H- 120/150  S ₁ X7	q M8*35  X14
---	--	---	--	--

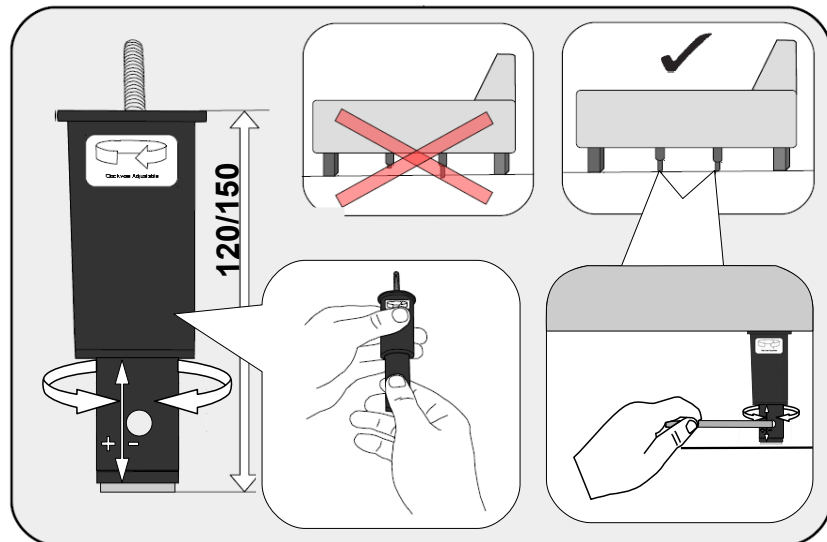
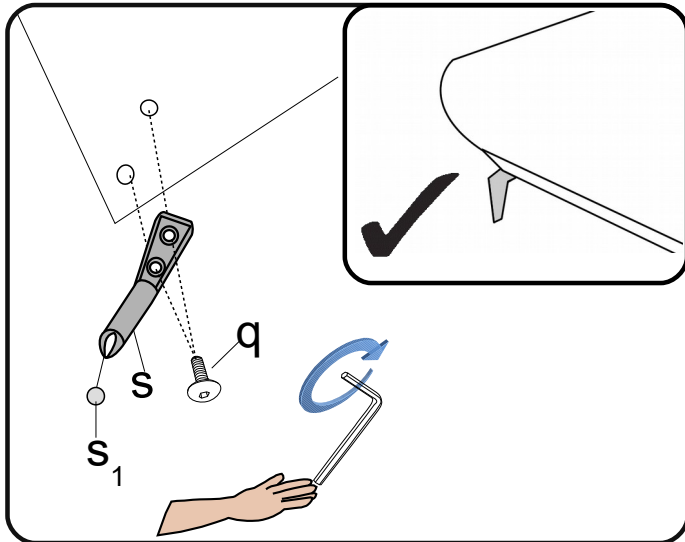
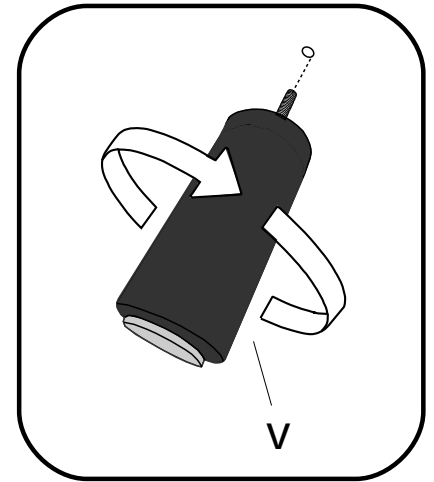
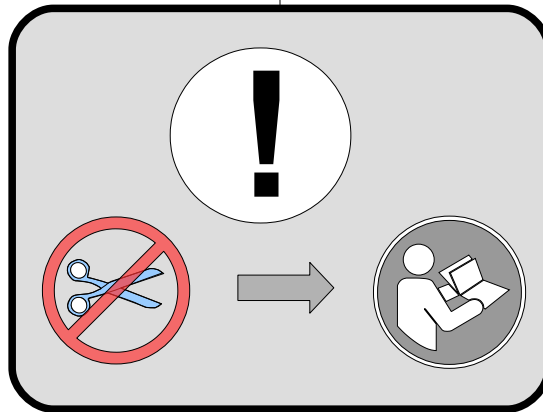
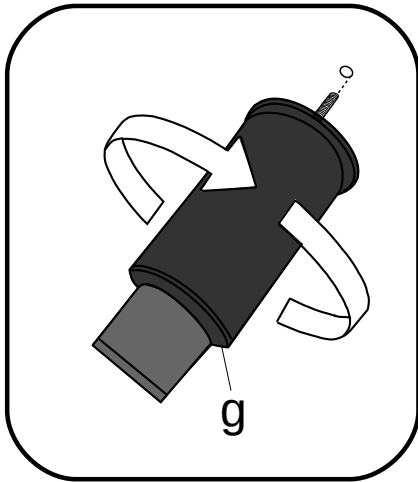
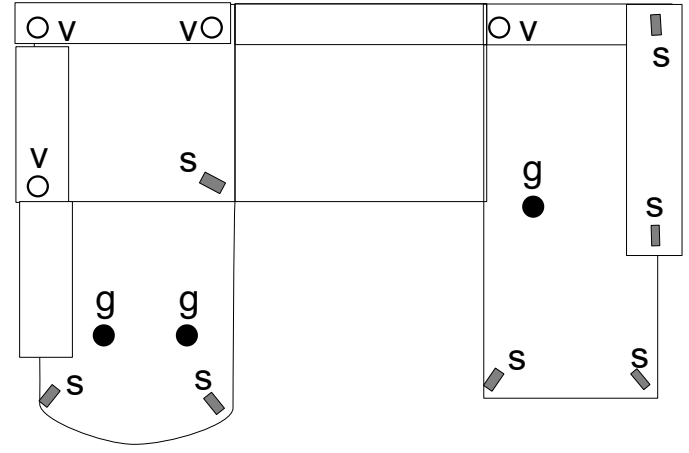
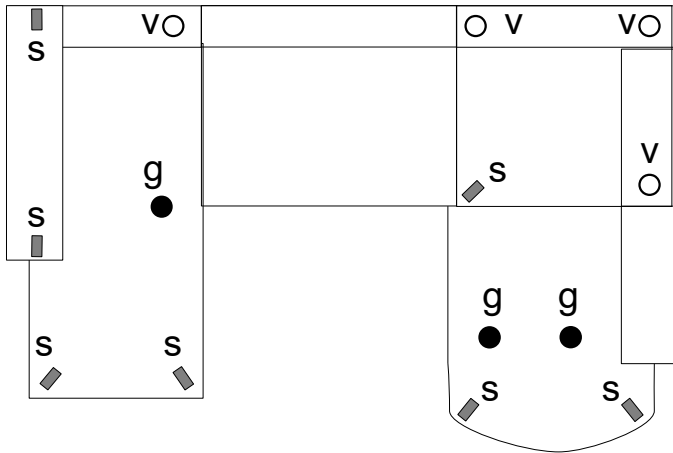
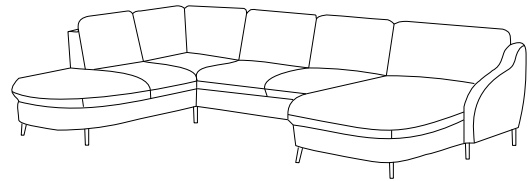
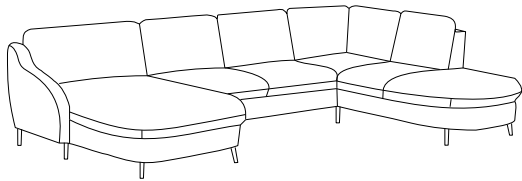

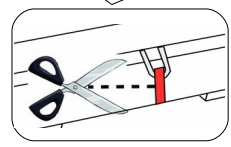
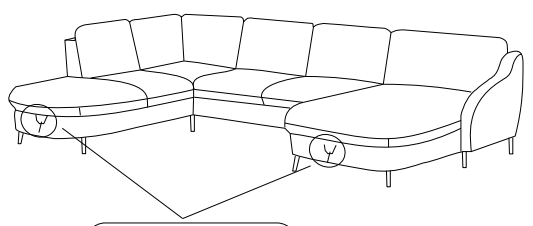
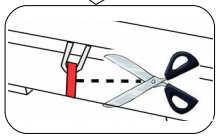
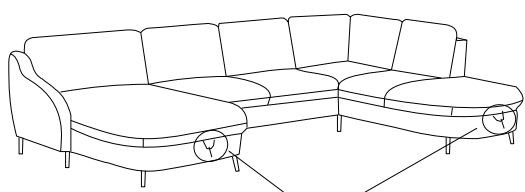
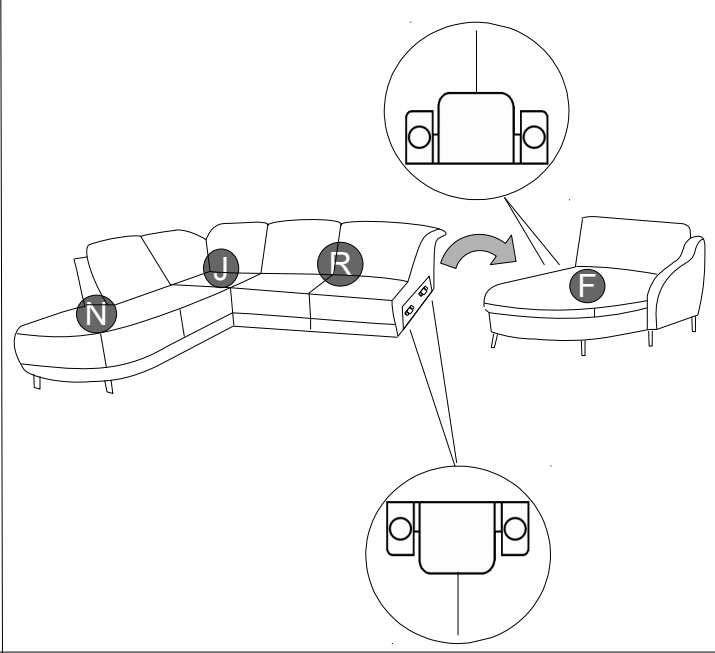
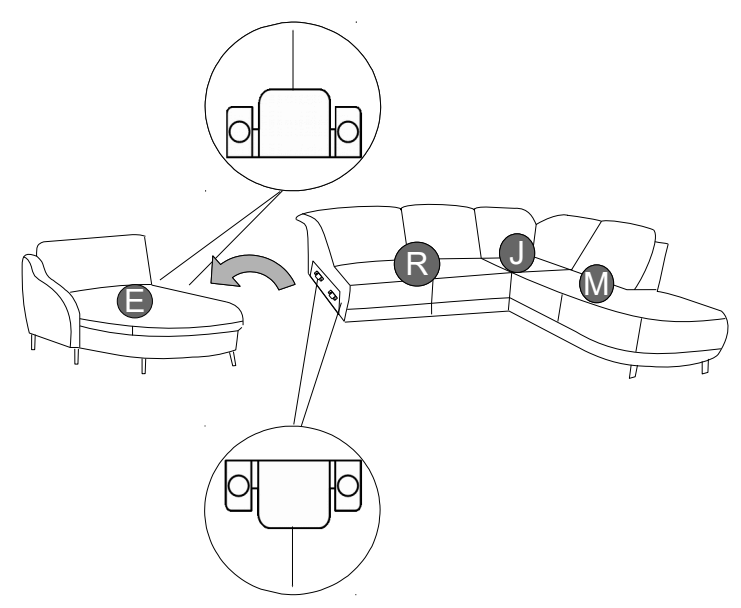
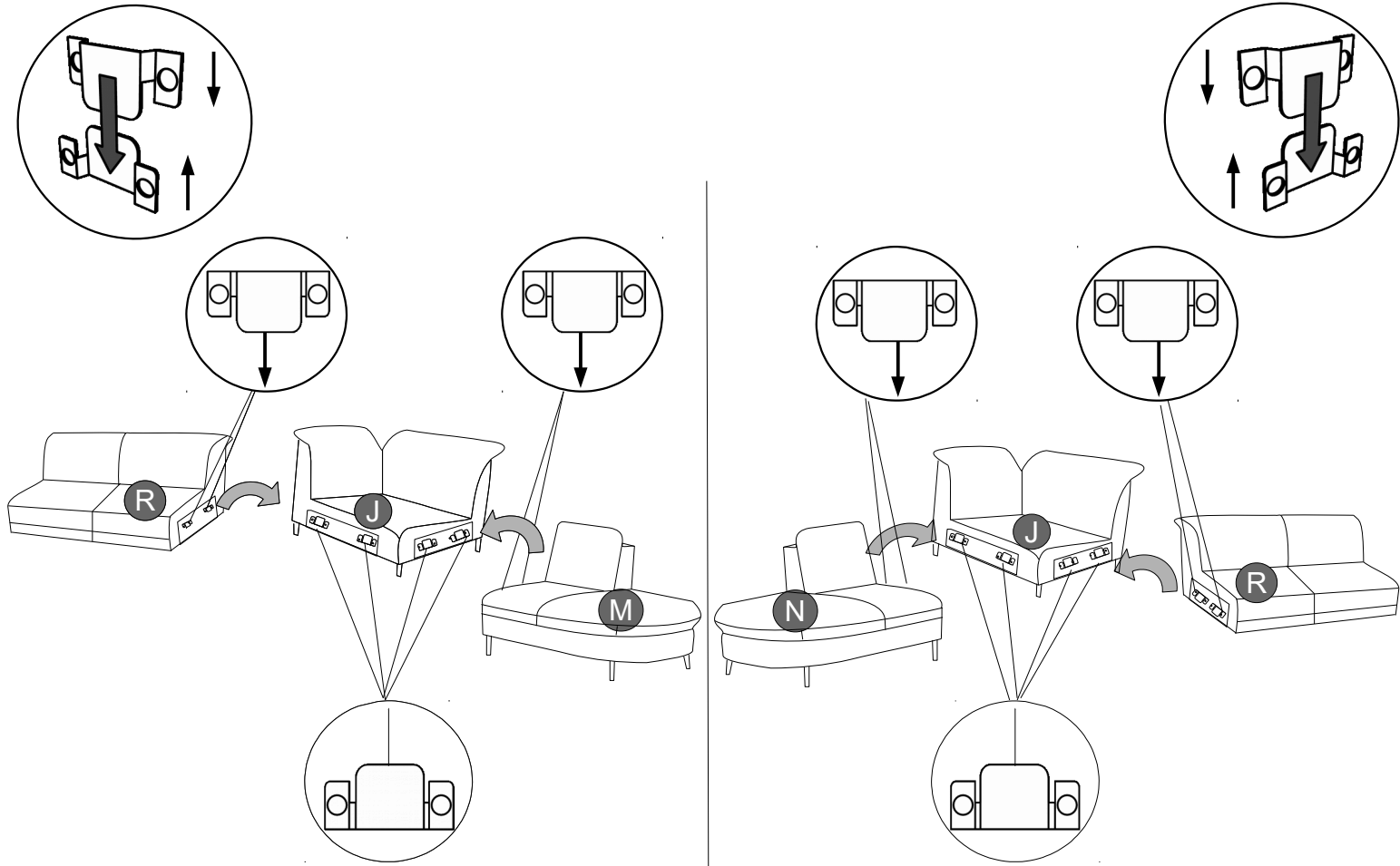

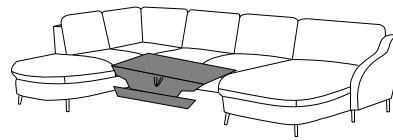
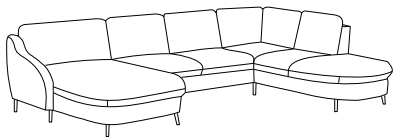

0019

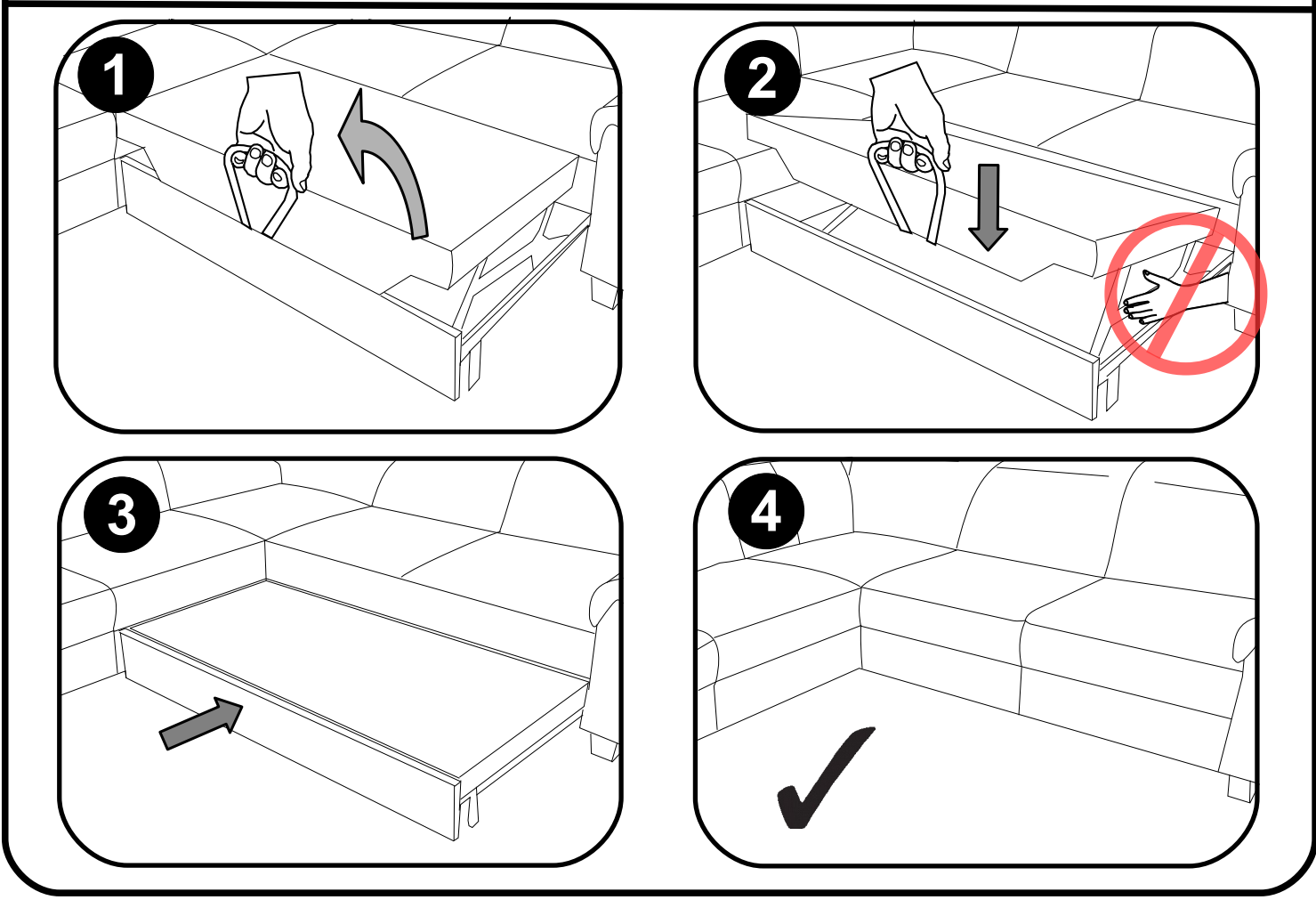
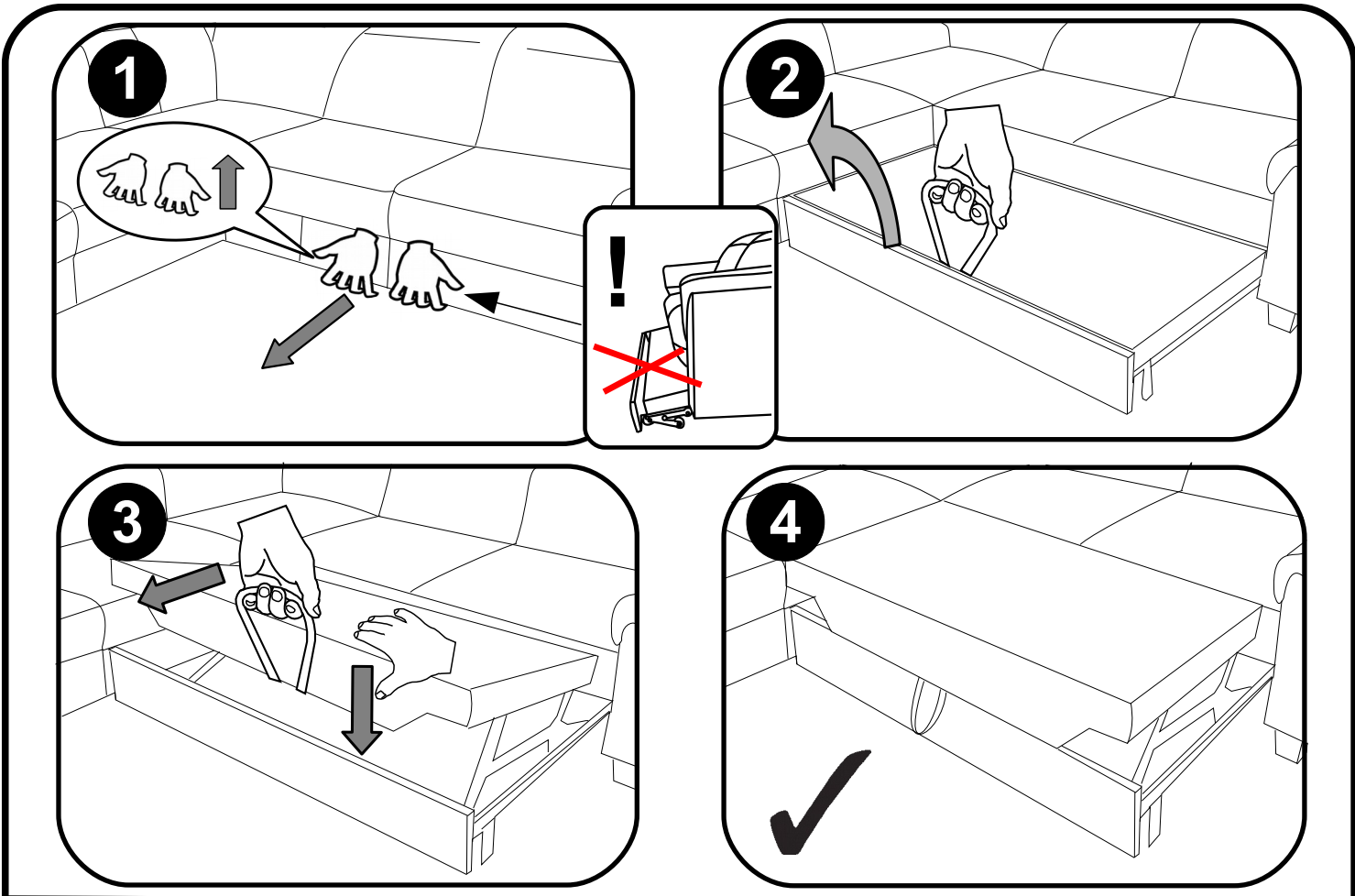

Service · Dienstverlening · Serwis · Servis · Сервисная служба · Serviciu · Services · Servizio
 · Servisný list · Szolgáltatás · Servisní list

Name · Naam · Nazwa · İsim · Название · Nume · Nome · Název · Názov ·
 Název · Neve

SOUL

Typ · Type · Tip · Тип · Tipo · Típus

