

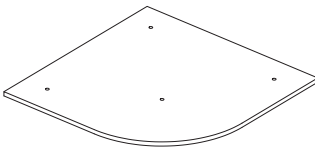

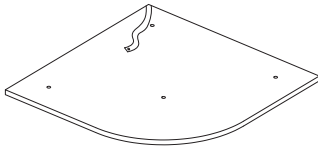

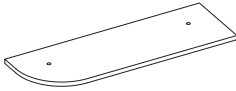

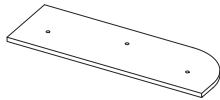



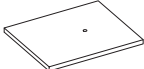
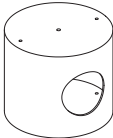
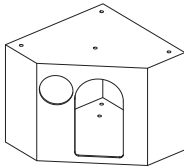
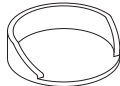









**INSTRUCTION MANUAL/BEDIENUNGSANLEITUNG/NOTICE D'UTILISATION/  
MANUAL DE INSTRUCCIONES DE USO/MANUALE DI ISTRUZIONI**

**PARTS LIST/STÜCKLISTE/PARTS LIST/LISTA DE PIEZAS/LISTA DEI PEZZI**

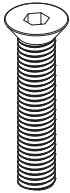
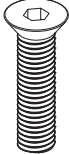
<p>A1</p>  <p>59.5x59.5cm 1pc</p>	<p>A2</p>  <p>59.5x59.5cm 1pc</p>	<p>B1</p>  <p>60x20cm 1pc</p>	<p>B2</p>  <p>60x20cm 1pc</p>		
<p>C</p>  <p>29x29cm 1pc</p>	<p>D</p>  <p>29x24cm 2pcs</p>	<p>E</p>  <p>30x30x25cm 1pc</p>	<p>F</p>  <p>34x34x30cm 1pc</p>	<p>G</p>  <p>30x30cm 1pc</p>	<p>H</p>  <p>36x36cm 2pcs</p>
<p>I</p>  <p>1pc</p>	<p>J</p>  <p>25cm 2pcs</p>	<p>K</p>  <p>30cm 2pcs</p>	<p>E1</p>  <p>3.5x21cm 2pcs</p>	<p>F1</p>  <p>3.5x27cm 3pcs</p>	<p>L</p>  <p>40cm 1pc</p>
<p>M</p>  <p>37cm 1pc</p>	<p>N</p>  <p>38.5cm 2pcs</p>	<p>O</p>  <p>40cm 1pc</p>	<p>P</p>  <p>43cm 4pcs</p>	<p>Q</p>  <p>46cm 1pc</p>	<p>R</p>  <p>50cm 1pc</p>
<p>S</p>  <p>M10x60 9pcs</p>	<p>T</p>  <p>M10x50 1pc</p>	<p>U</p>  <p>M10x40 7pcs</p>	<p>V</p>  <p>M8x40 10pcs</p>	<p>W</p>  <p>ST4x30 1pc</p>	<p>X</p>  <p>1pc</p>
<p>Y1</p>  <p>S5 1pc</p>	<p>Y2</p>  <p>S6 1pc</p>				

RETAIN FOR FUTURE REFERENCE  
FÜR KÜNFTIGE VERWENDUNG AUFBEWAHREN  
A CONSERVER POUR UNE UTILISATION FUTURE  
CONSERVAR PARA SER LEÍDO POR CADA NUEVO USUARIO,  
ANTES DE UTILIZAR EL ARTÍCULO POR PRIMERA VEZ  
CONSERVARE PER CONSULTAZIONI FUTURE

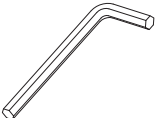
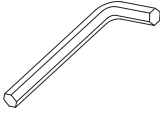
# ASSEMBLY/MONTAGE/ASSEMBLAGE/MONTAJE/ASSEMBLAGGIO



**Warning!**  
**Warnung!**  
**Attention !**  
**Atención!**  
**Avvertimento!**

Tight all the screws to 60% first then tight to 100%.  
 Während der Montage alle Schrauben zuerst 60% anziehen, dann zu 100%.  
 Serrez toutes les vis à 60% d'abord puis serrez à 100%.  
 Primero apriete los tornillos al 60% y después al 100%.  
 Stringere le viti dapprima al 60% e successivamente completamente al 100%.

1

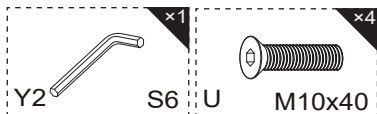
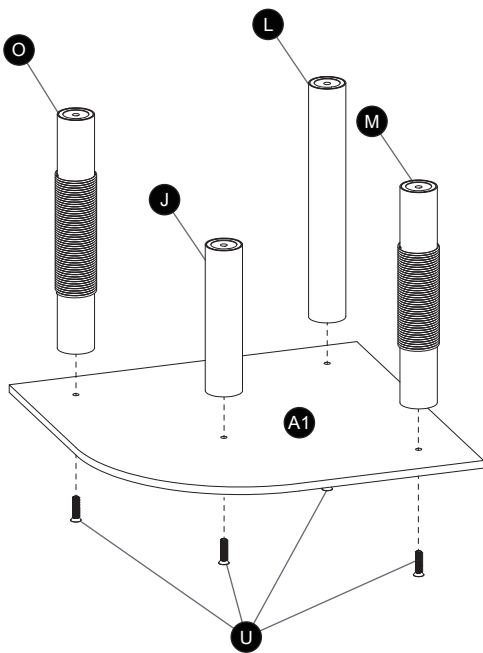

2

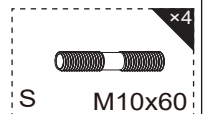
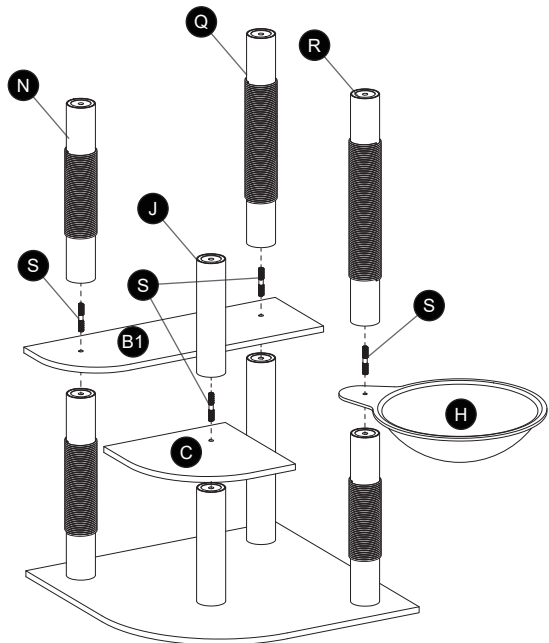

3

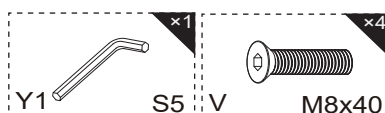
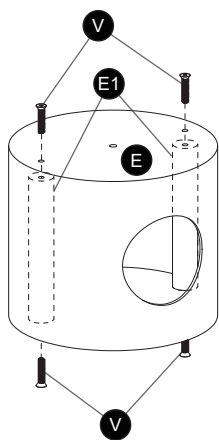

4

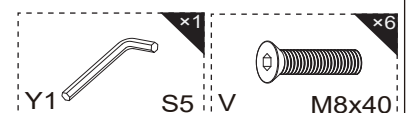
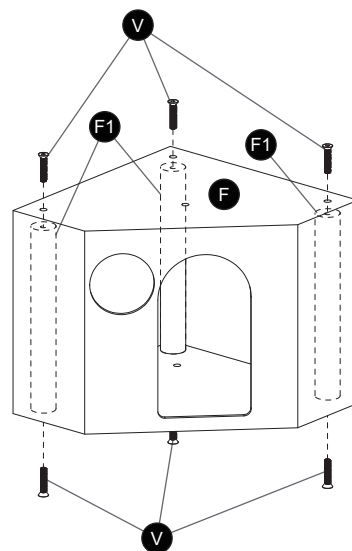



**Warning!**  
**Warnung!**  
**Attention !**  
**Atención!**  
**Avvertimento!**

Tight all the screws to 60% first then tight to 100%.  
Während der Montage alle Schrauben zuerst 60% anziehen, dann zu 100%.  
Serrez toutes les vis à 60% d'abord puis serrez à 100%.  
Primero apriete los tornillos al 60% y después al 100%.  
Stringere le viti dapprima al 60% e successivamente completamente al 100%.

5

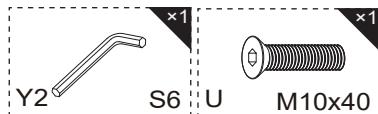
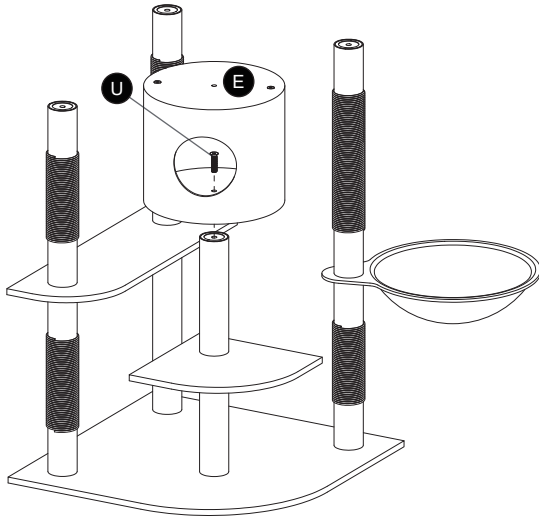

6

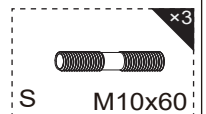
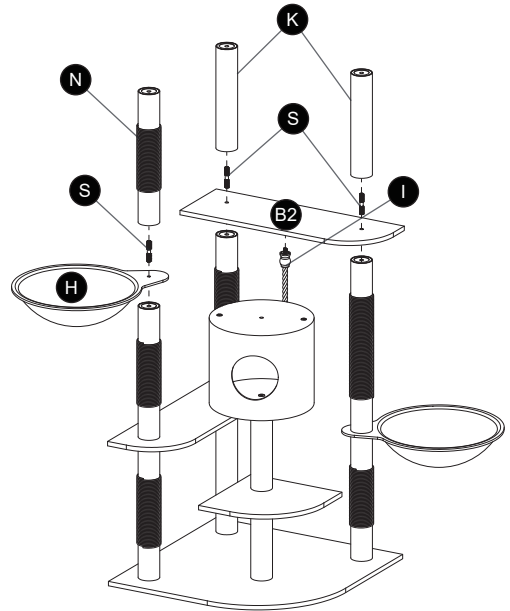

7

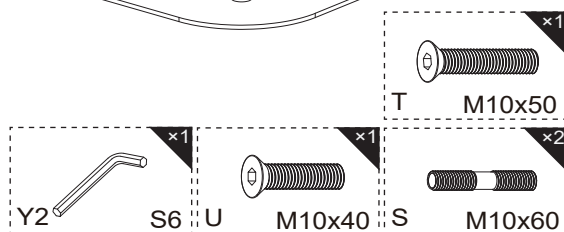
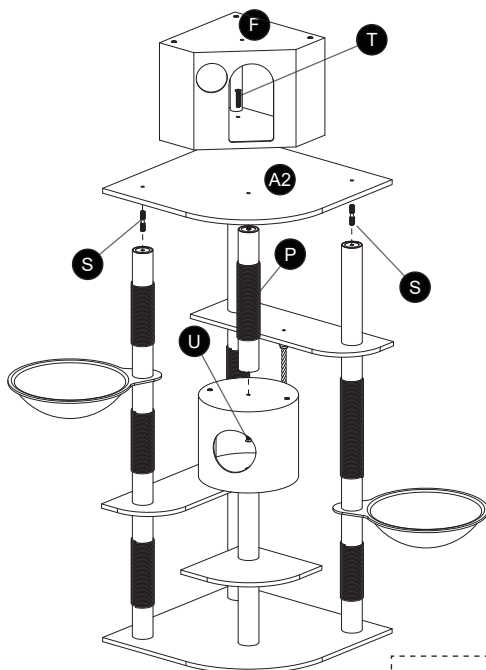

8

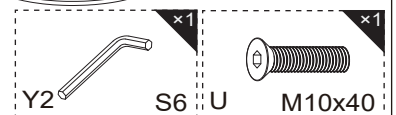
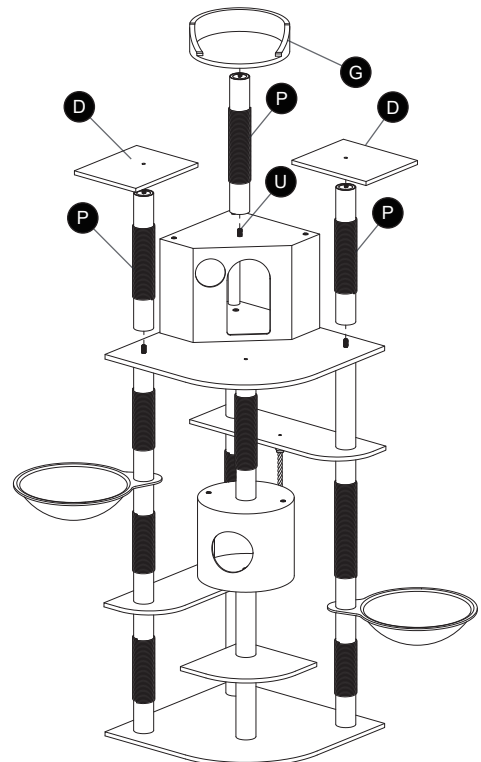



**Warning!**  
**Warnung!**  
**Attention !**  
**Atención!**  
**Avvertimento!**

Tight all the screws to 60% first then tight to 100%.  
Während der Montage alle Schrauben zuerst 60% anziehen, dann zu 100%.  
Serrez toutes les vis à 60% d'abord puis serrez à 100%.  
Primero apriete los tornillos al 60% y después al 100%.  
Stringere le viti dapprima al 60% e successivamente completamente al 100%.

9

