

WF313229

WF313230

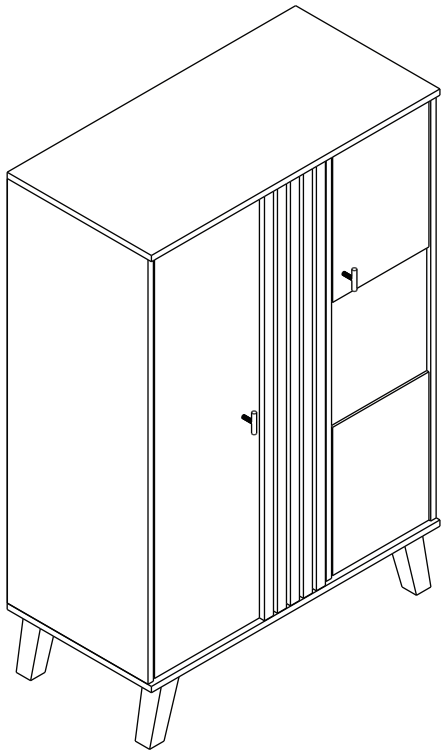

Note: Please do not fully tighten all the screws until the overall frame is built

Bitte überprüfen Sie, ob alle Teile mitgeliefert sind, bevor Sie mit der Montage beginnen. Wenn Sie festlegen, dass etwas fehlt, setzen Sie die Montage nicht fort. Bitte kontaktieren Sie uns sofort.

Achtung : Bitte ziehen Sie nicht alle Schrauben fest, bevor die Montage abgeschlossen ist !

D Gebrauchsanweisung

NL Gebruiksrichtlijnen

IT Istruzioni per l'uso

CZ Pokyny k použití

HU Használati útmutató

PT Instruções de utilização

SK Pokyny k použitiu

GB Instructions for use

FR Instructions d'utilisation

PL Instrukcja obsługi

ES Instrucciones de empleo

RO Instrucțiuni de folosire

RU Инструкция по монтажу

TR Kullanım talimatları

This set will be shipped by 2 boxes and they may arrive on different days. If both packages arrived but parts missing, please contact customer service.

Dieses Set ist in 2 Boxen enthalten. Wenn Sie keine vollen 2 Boxen erhalten, wenden Sie sich bitte an unseren Kundenservice

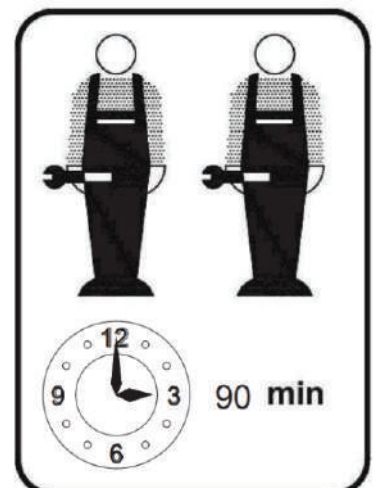

**FR - Notice de montage / EN - Assembly instructions / PT - Instruções de montagem /
ES - Prospecto de montaje / DE - Montageanleitung / IT - Istruzioni di montaggio /
NL - Montagehandleiding**

FR - IMPORTANT! CONSERVER POUR CONSULTATION ULTERIEURE: LIRE ATTENTIVEMENT

- A monter par un adulte. Un adulte doit vérifier le bon assemblage avant l'emploi
- ATTENTION! tenir les vis et petits éléments et sachets hors de portée des enfants
- Bien identifier les éléments avant de commencer le montage
- Ne pas utiliser votre article lorsque l'un de ses éléments est cassé ou manquant
- En cas de problème contactez notre service après-vente
- Toujours suivre les instructions du fabricant
- Entretien: nettoyer avec un chiffon doux et sec. En cas de taches plus grosses, frottez soigneusement avec une éponge légèrement humide et non abrasive
- Ne pas sauter sur le lit

EN - IMPORTANT! KEEP FOR FUTURE REFERENCE: READ CAREFULLY

- To be assembled by an adult. Assembly must be checked by an adult before use
- WARNING! keep all screws, small parts and plastic bags out of the reach of children
- Properly identify all parts before assembling
- Never use your item if any of its parts are broken or missing
- Should any problems arise, please contact our After Sales Service
- Manufacturer's instructions shall be followed at all times
- Care: clean with a soft, dry cloth. In case of larger stains, carefully rub with a slightly damp, non-abrasive sponge
- Do not jump on the bed

PT - IMPORTANTE! GUARDE PARA CONSULTA POSTERIOR: LER ESTAS INSTRUÇÕES CUIDADOSAMENTE

- A ser montado por um adulto. Um adulto deve verificar a boa montagem antes da utilização
- Atenção! mantenha os parafusos, acessórios pequenos e saco de plástico fora do alcance das crianças
- Identifique bem os acessórios antes de começar a montagem
- Não utilizar o artigo se um dos elementos está em falta ou danificado
- Para qualquer esclarecimento, contacte os nossos serviços através do telefone
- As instruções do fabricante devem ser sempre cumpridas
- Manutenção: limpe com um pano macio e seco. Em caso de manchas maiores, esfregue cuidadosamente com uma esponja ligeiramente húmida e não abrasiva
- Não salte na cama

ES - IMPORTANTE! CONSERVAR PARA FUTURAS CONSULTAS: LEER DETENIDAMENTE

- A montar por un adulto. Un adulto debe comprobar el buen montaje antes de la utilización
- ¡ADVERTENCIA! mantener los tornillos, los pequeños elementos y bolsitas fuera del alcance de los niños
- Identificar debidamente los elementos antes de empezar el montaje
- No utilizar este artículo si uno de los elementos falta o esta roto
- Si tiene problemas, contactar nuestro servicio postventa
- Deben seguirse siempre las instrucciones del fabricante Cuidados: limpiar con un paño suave y seco. En caso de manchas grandes, frotar con cuidado utilizando una esponja húmeda no abrasiva
- No saltar sobre la cama

DE - WICHTIG! FÜR SPÄTERE BEZUGNAHME AUFBEWAHREN: SORGFÄLTIG LESEN

- Von einem Erwachsenen zu montieren. Die korrekte Montage muss vor Gebrauch von einem Erwachsenen geprüft werden
- Achtung! die Schrauben und kleinen Teile ausserhalb der Reichweite von Kindern lagern
- Vor Montagebeginn alle Teile identifizieren
- Ihren Artikel nicht benutzen, wenn eines seiner Bestandteile beschädigt ist oder fehlt
- Im Problemfall Ihren Kundendienst anrufen
- Stets die Herstelleranweisungen beachten
- Wartung: Mit einem weichen, trockenen Tuch reinigen. Bei größeren Flecken vorsichtig mit einem leicht feuchten, nicht scheuernden Schwamm abreiben
- Nicht auf dem Bett springen

IT - IMPORTANTE! CONSERVARE QUESTE INFORMAZIONI PER ULTERIORI CONSULTAZIONI: LEGGI ATTENTAMENTE

- Il montaggio deve essere eseguito da un adulto. Un adulto dovrà verificare il corretto montaggio prima dell'uso
- ATTENZIONE! tenere le viti ed i componenti di piccole dimensioni lontano dalla portata dei bambini
- Controllare i pezzi prima del montaggio
- L'articolo non deve essere utilizzato in caso di elementi mancanti o danneggiati
- In caso di necessità contattare il nostro servizio post-vendita
- Seguire sempre le istruzioni del costruttore
- Manutenzione: pulire con un panno morbido e asciutto. Per le macchine più grandi, strofinare accuratamente con una spugna leggermente umida e non abrasiva
- Non saltare sul letto

NL - BELANGRIJK! BEWAAR VOOR LATERE RAADPLEGING: LEES AANDACHTIG

- Moet door een volwassene worden gemonteerd. Voor gebruik moet een volwassene controleren dat het product goed in elkaar is gezet
- WAARSCHUWING! schroeven en kleine elementen en zakjes buiten bereik van kinderen houden
- De elementen goed identificeren alvorens met de montage te beginnen
- Uw artikel niet gebruiken wanneer een van de onderdelen kapot is of ontbreekt
- Neem bij problemen contact op met onze klantenservice
- Volg altijd de instructies van de fabrikant
- Onderhoud: maak schoon met een zachte en droge doek. In geval van grotere vlekken, veeg voorzichtig schoon met een licht bevochtigde en niet-schurende spons
- Niet springen op het bed

Stückliste

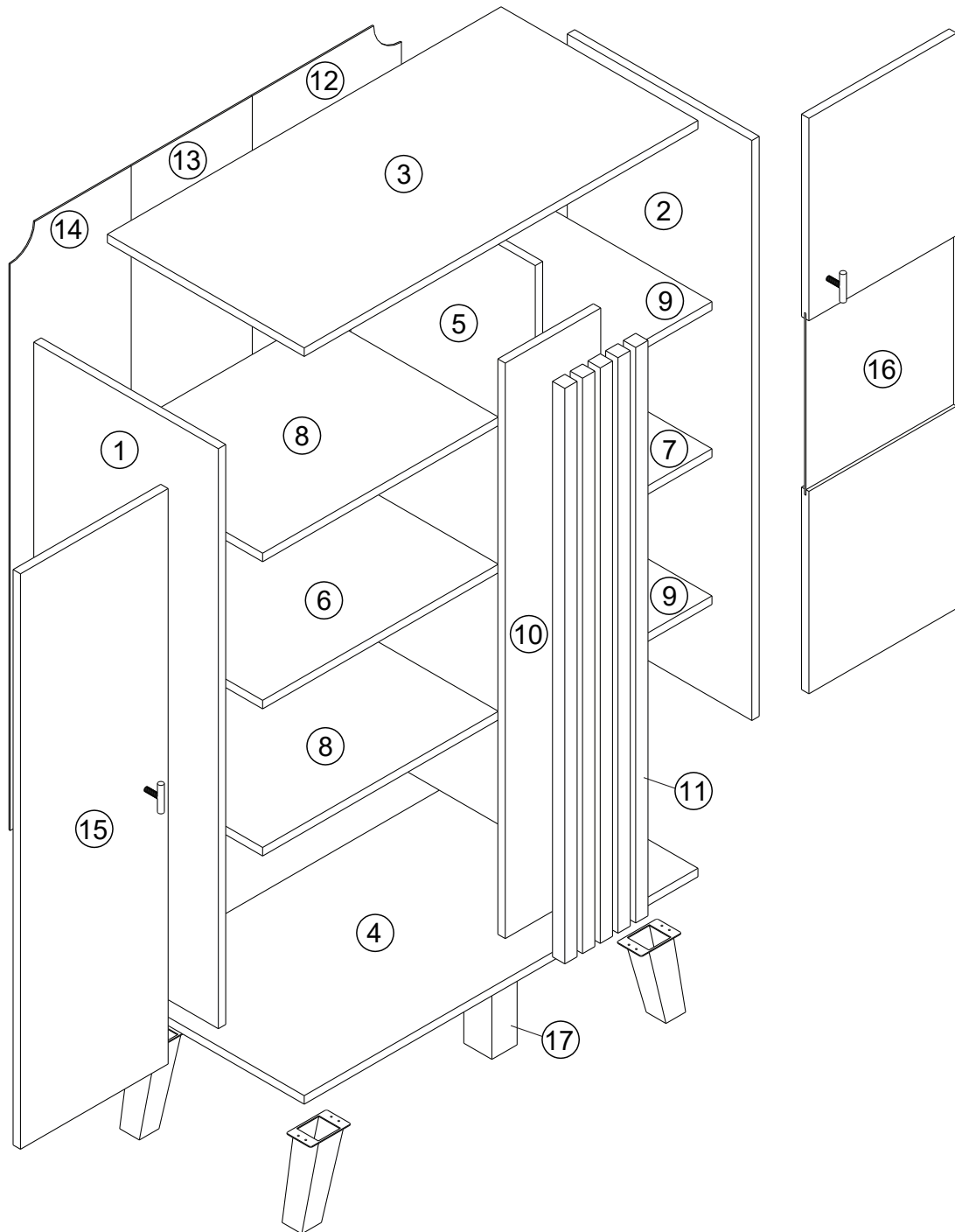



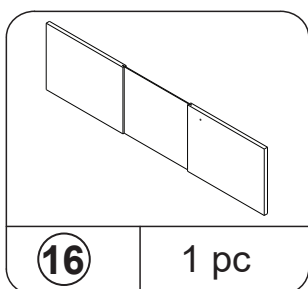
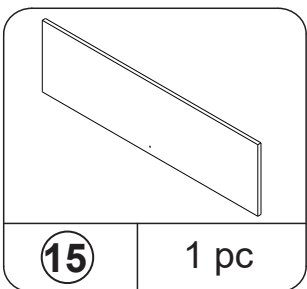
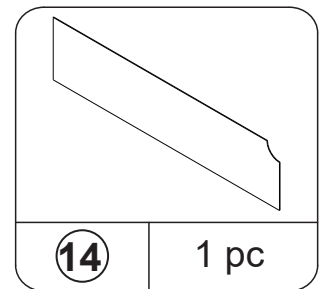
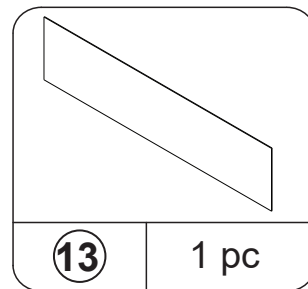
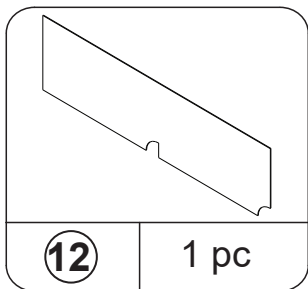
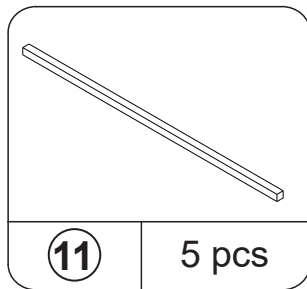
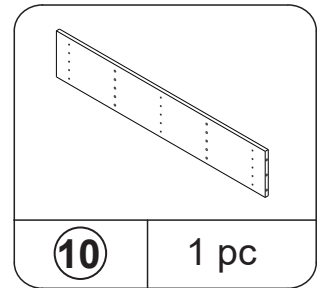
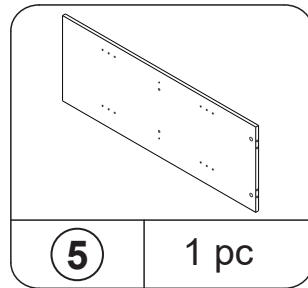
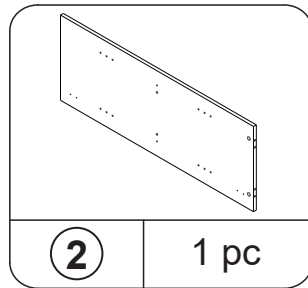
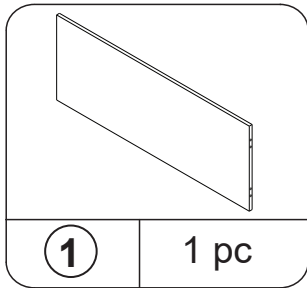



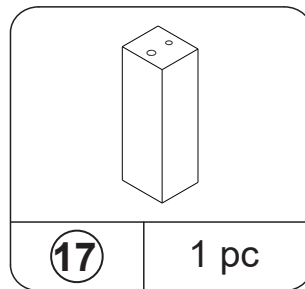
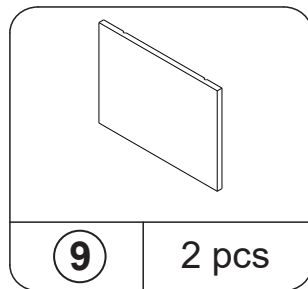
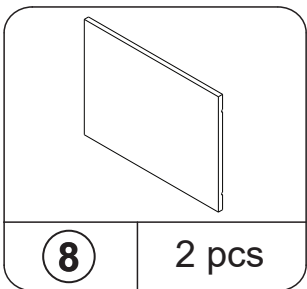
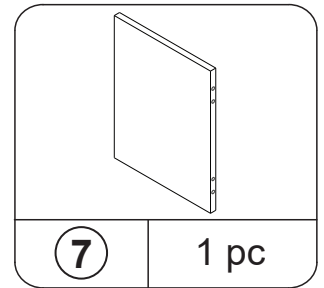
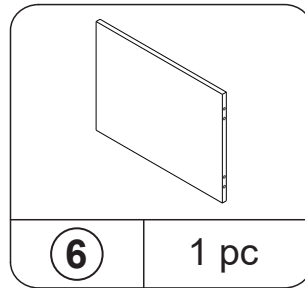
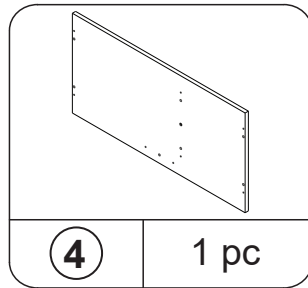
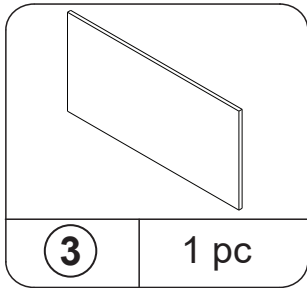



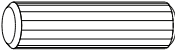

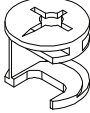
Part List-Stückliste WF313229

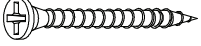

Part List-Stückliste WF313230

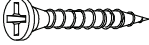
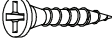
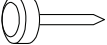

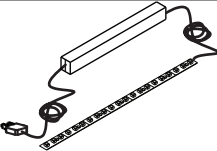
Hardware List- Hardware-Liste WF313230

			
A 33 pcs	B 16 pcs	C 16 pcs	D 4 pcs
			
E 4 pcs	F 2 sets	G 48 pcs	H 8 pcs
			
I 16 pcs	J 15 pcs	K 34 pcs	L 1 pc
			
M 1 pc	N 1 pc	O 1 set	P 2 pcs

Tools Required (Not Included)

Erforderliche Werkzeuge (nicht im Lieferumfang enthalten)

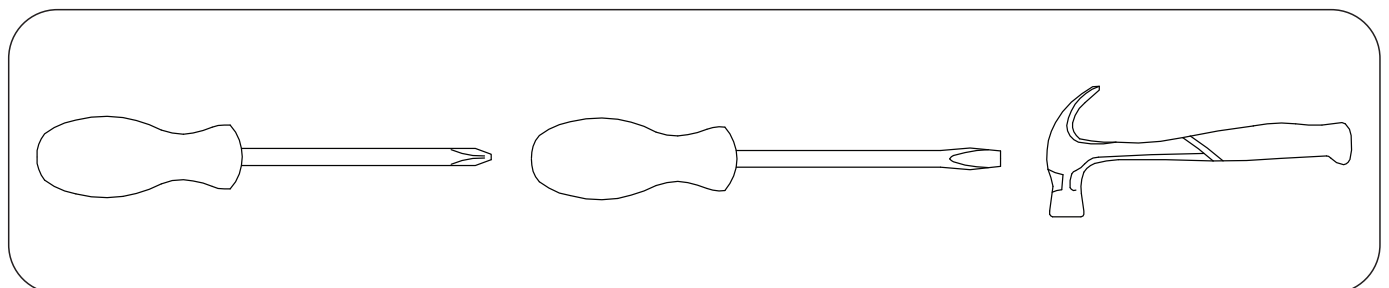

Hardware List- Hardware-Liste WF313230

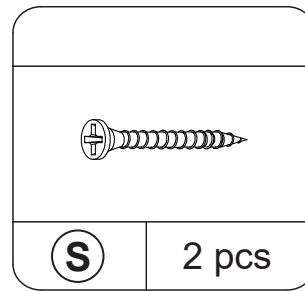
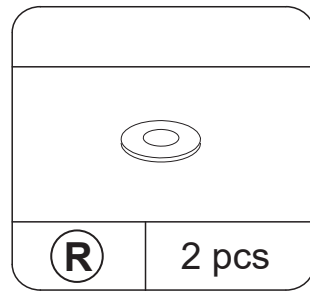
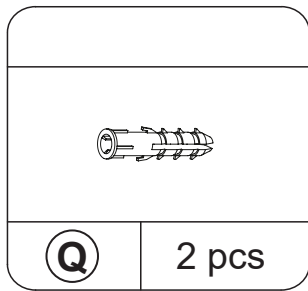

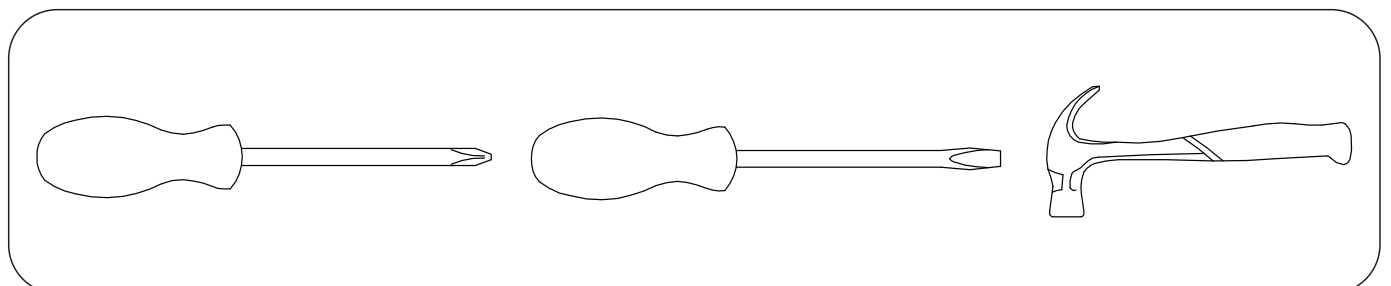

Tools Required (Not Included)

Erforderliche Werkzeuge (nicht im Lieferumfang enthalten)



1

		
A 23 pcs	B 16 pcs	L 1 pc

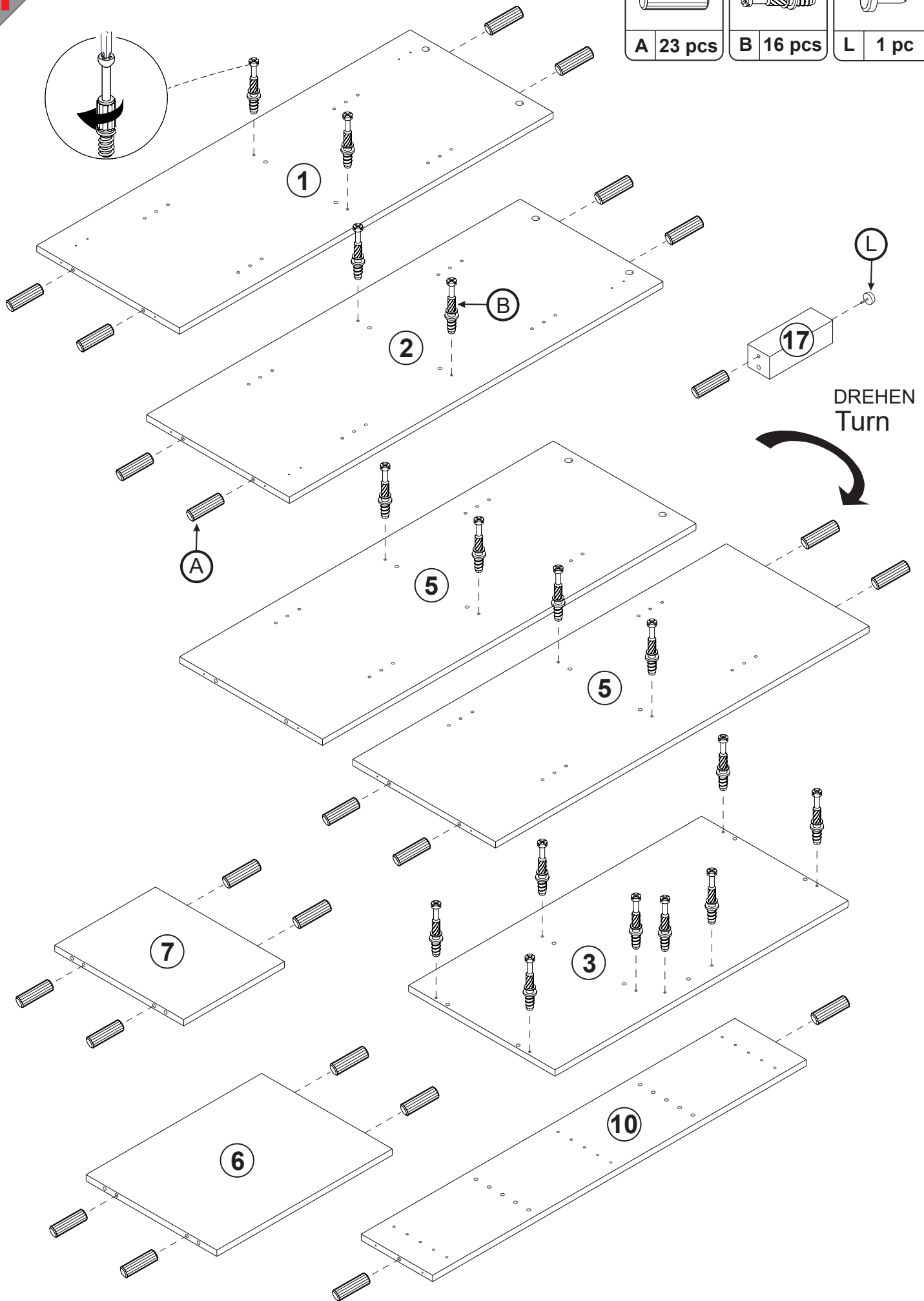

2

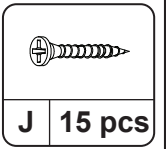
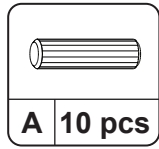
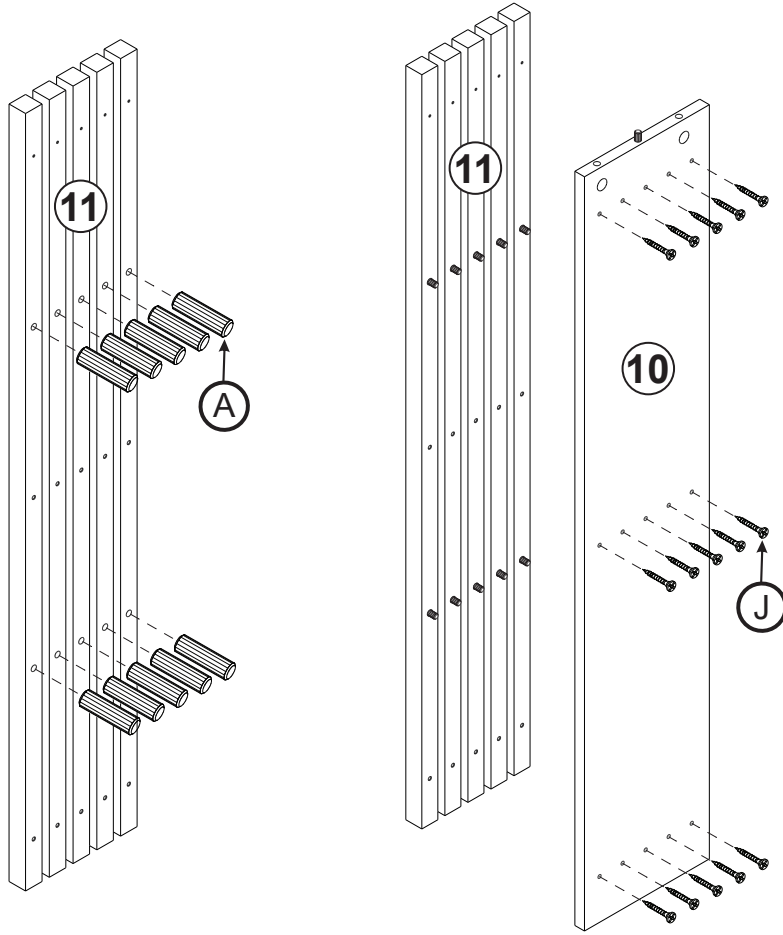

3

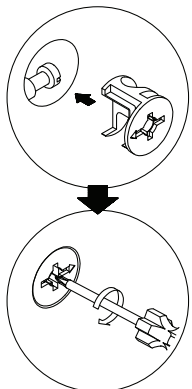
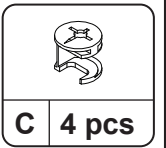
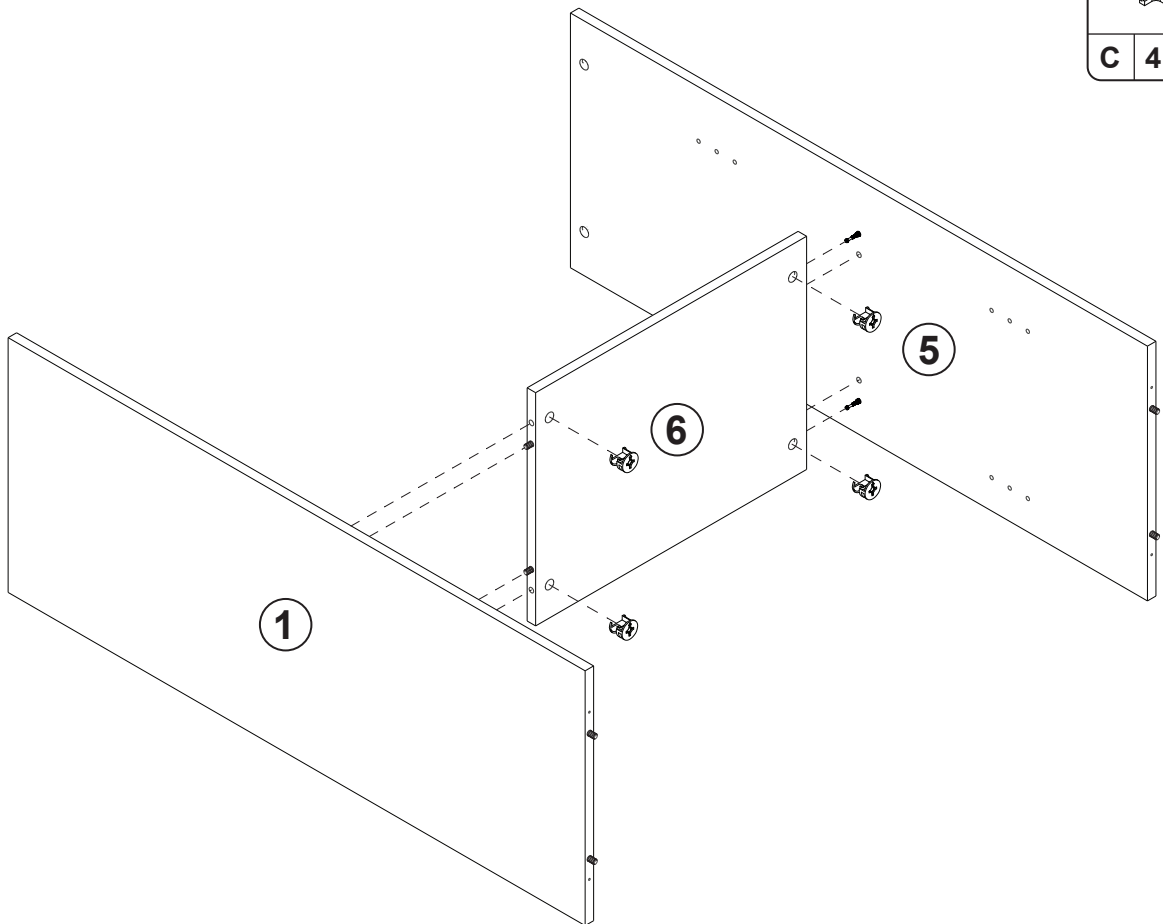

4

C 4 pcs

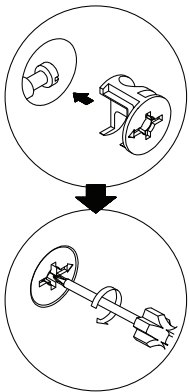
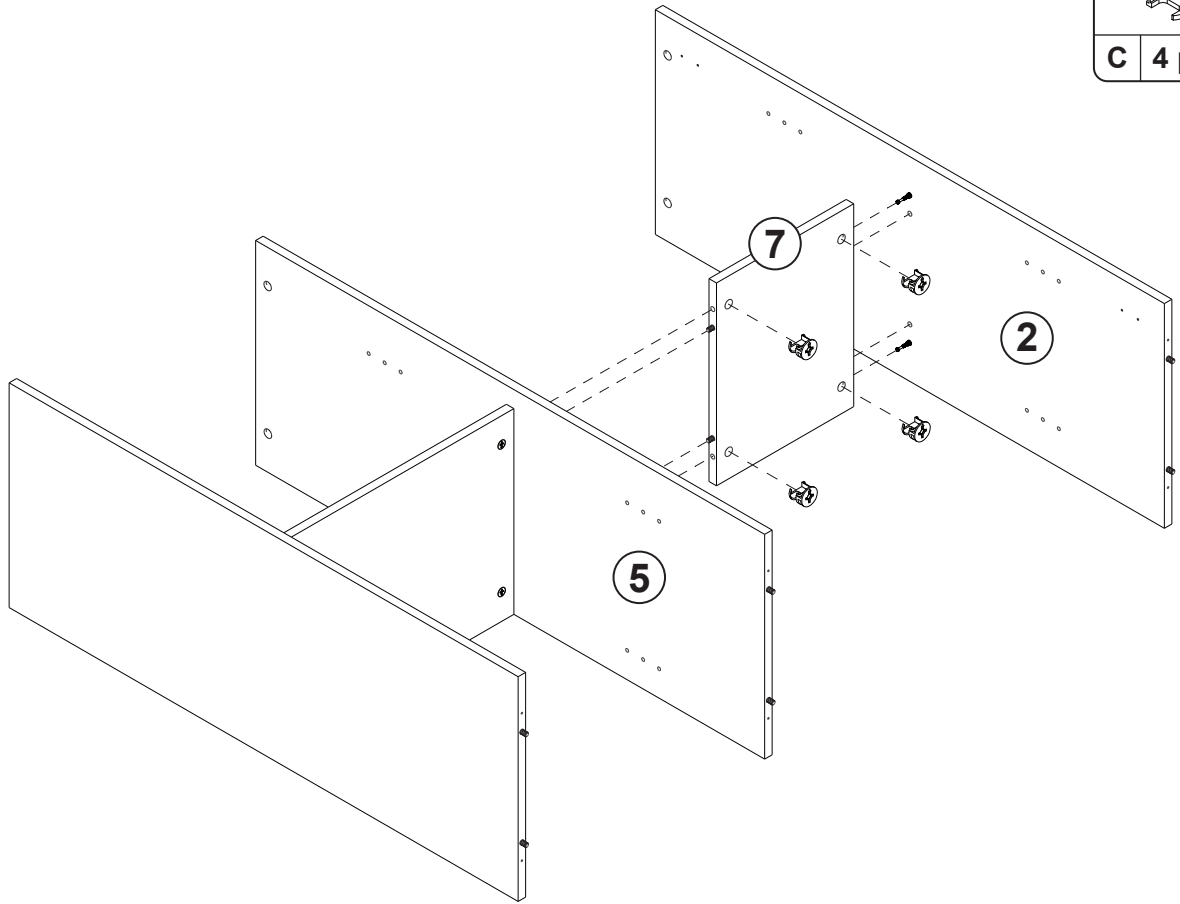

5

C 6 pcs

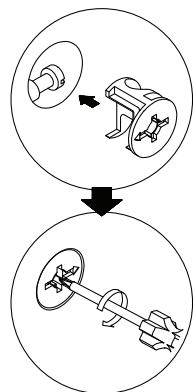
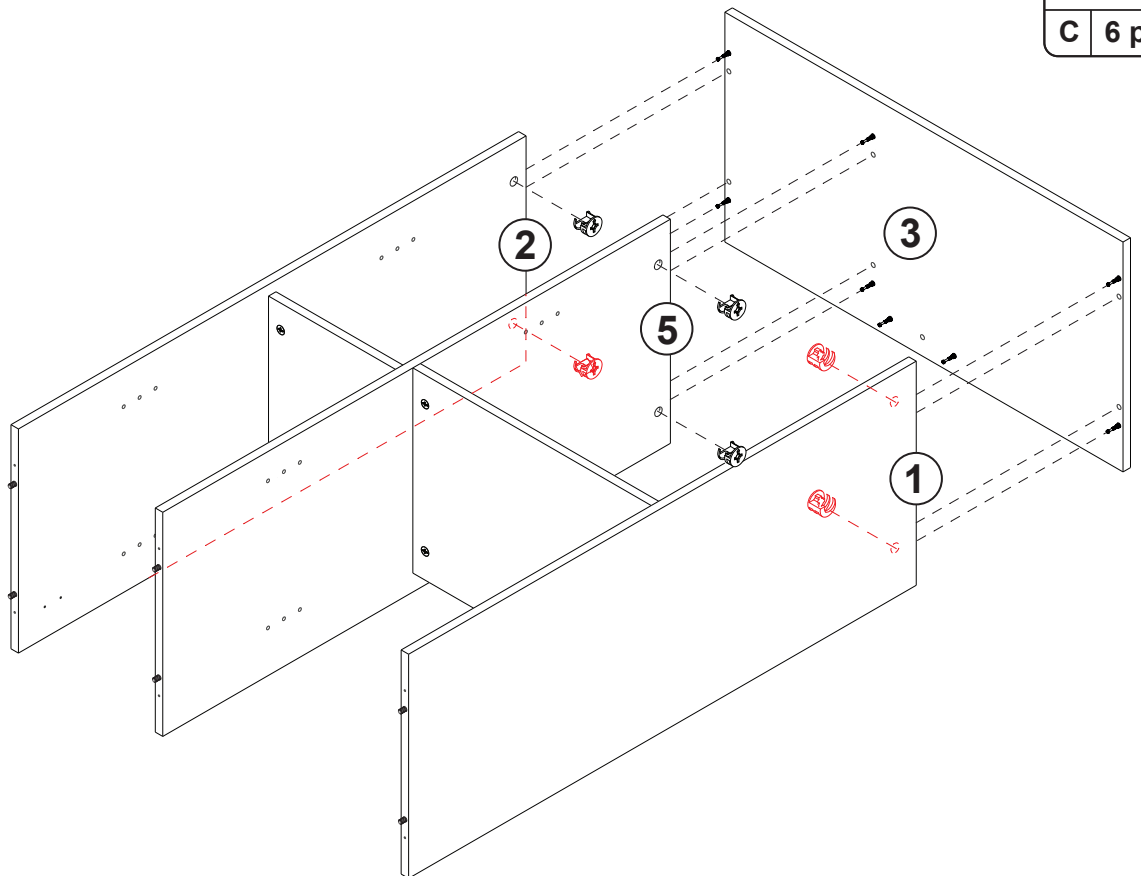

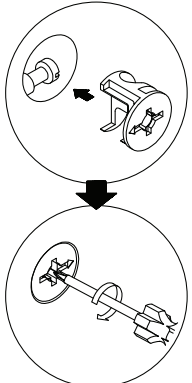
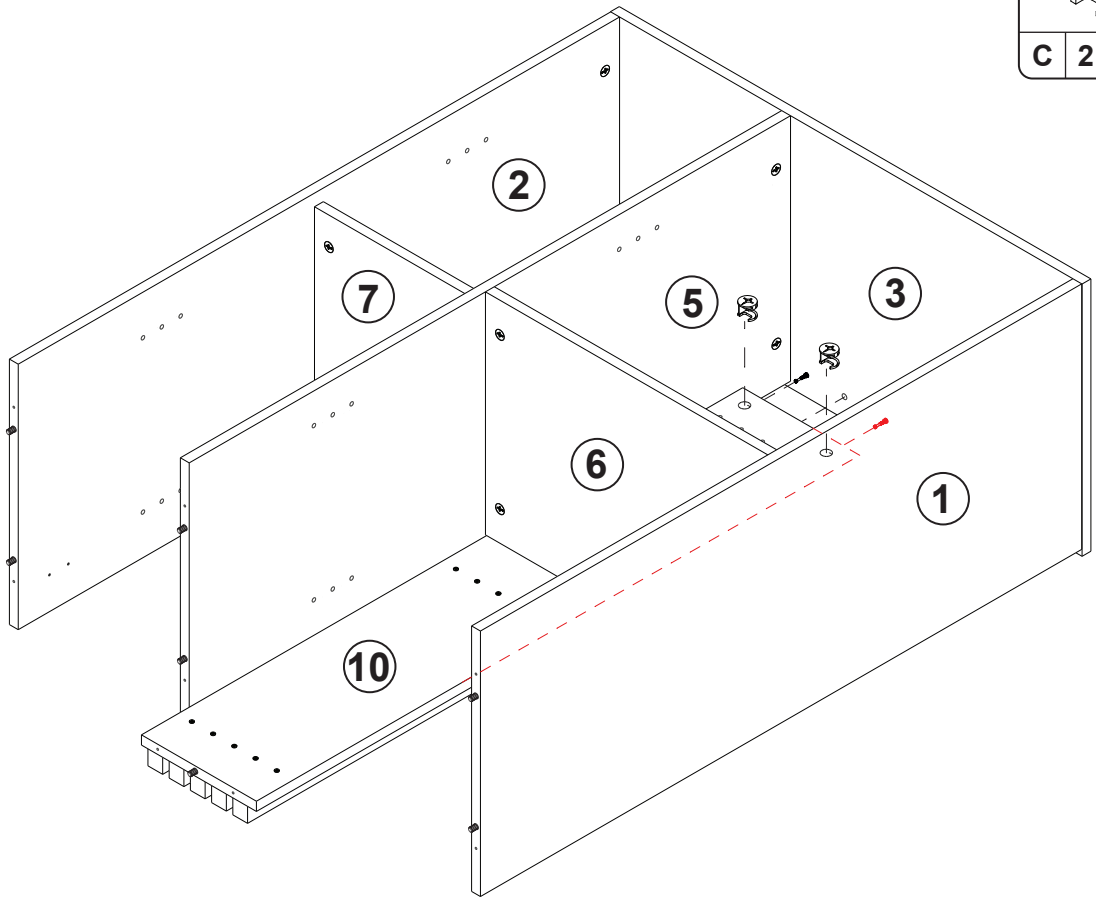

6

	
C	2 pcs



7

	
M	1 pc

	
N	1 pc

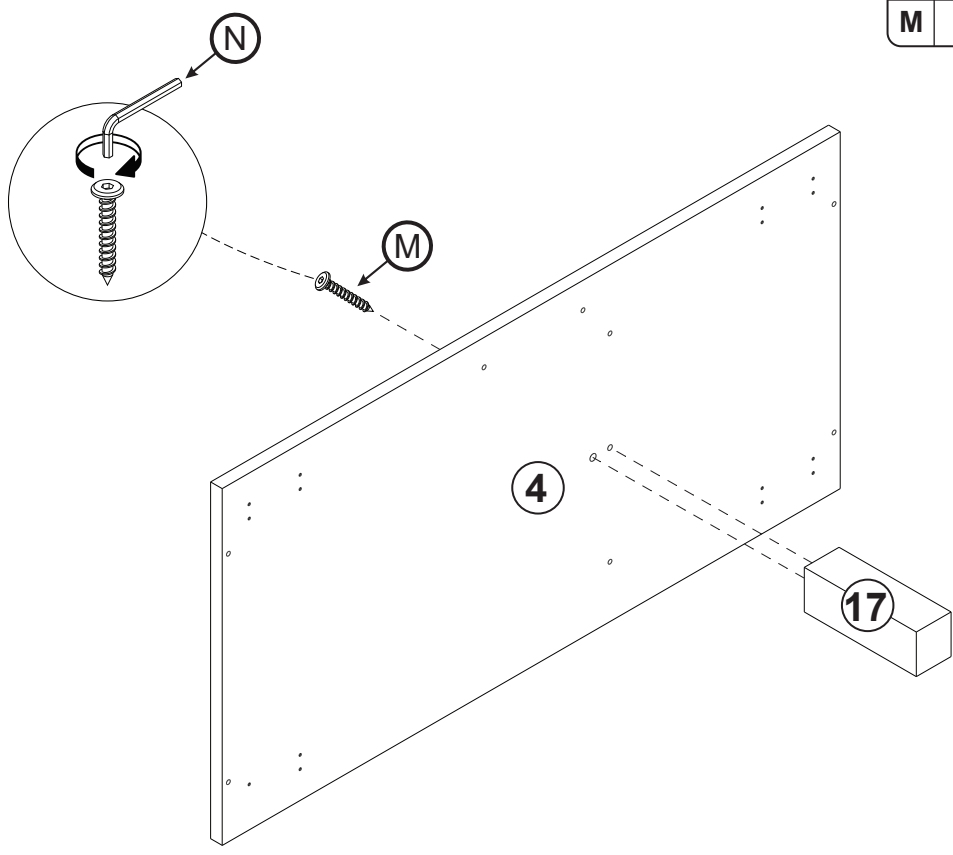

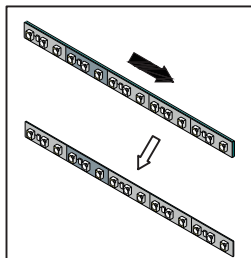
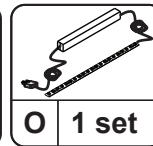
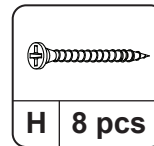
8

Remove the tape
before attaching the
light strip
Entfernen Sie das
Klebeband, bevor
Sie den Lichtstreifen
anbringen

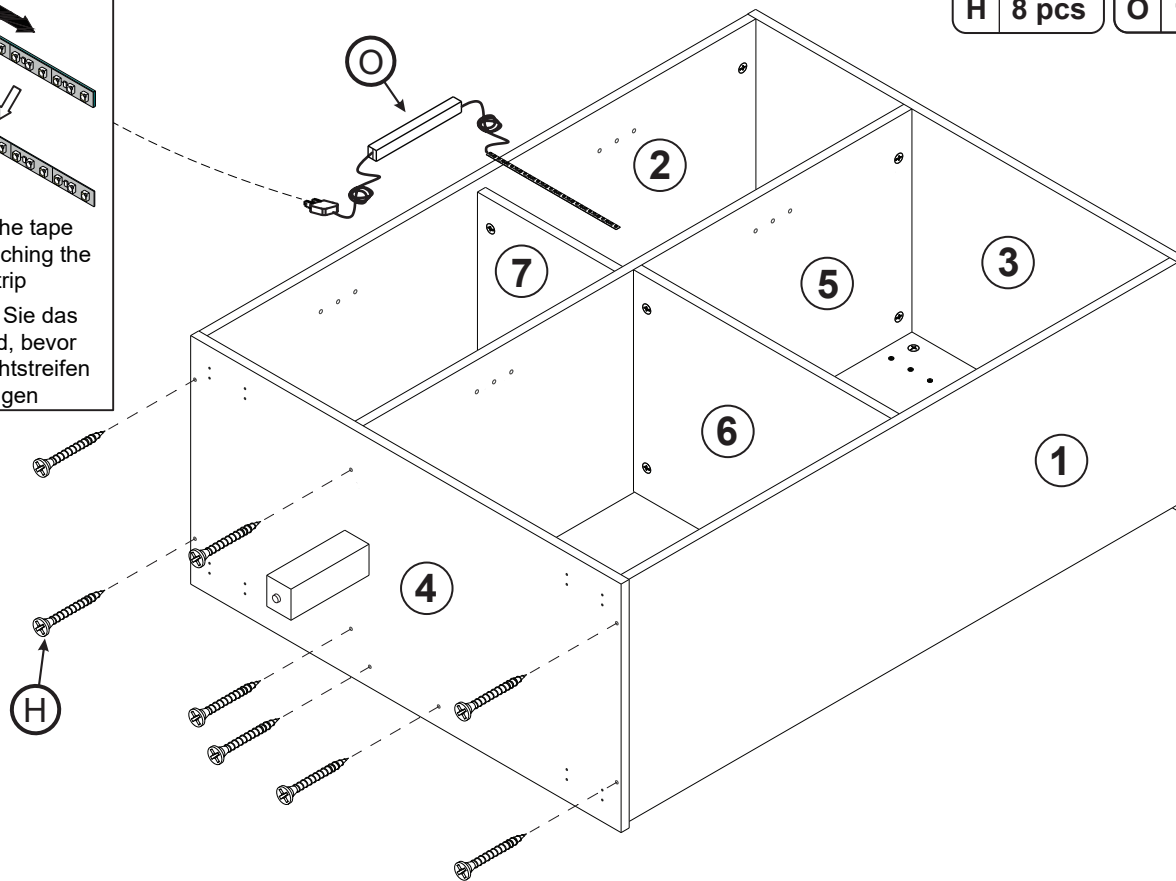
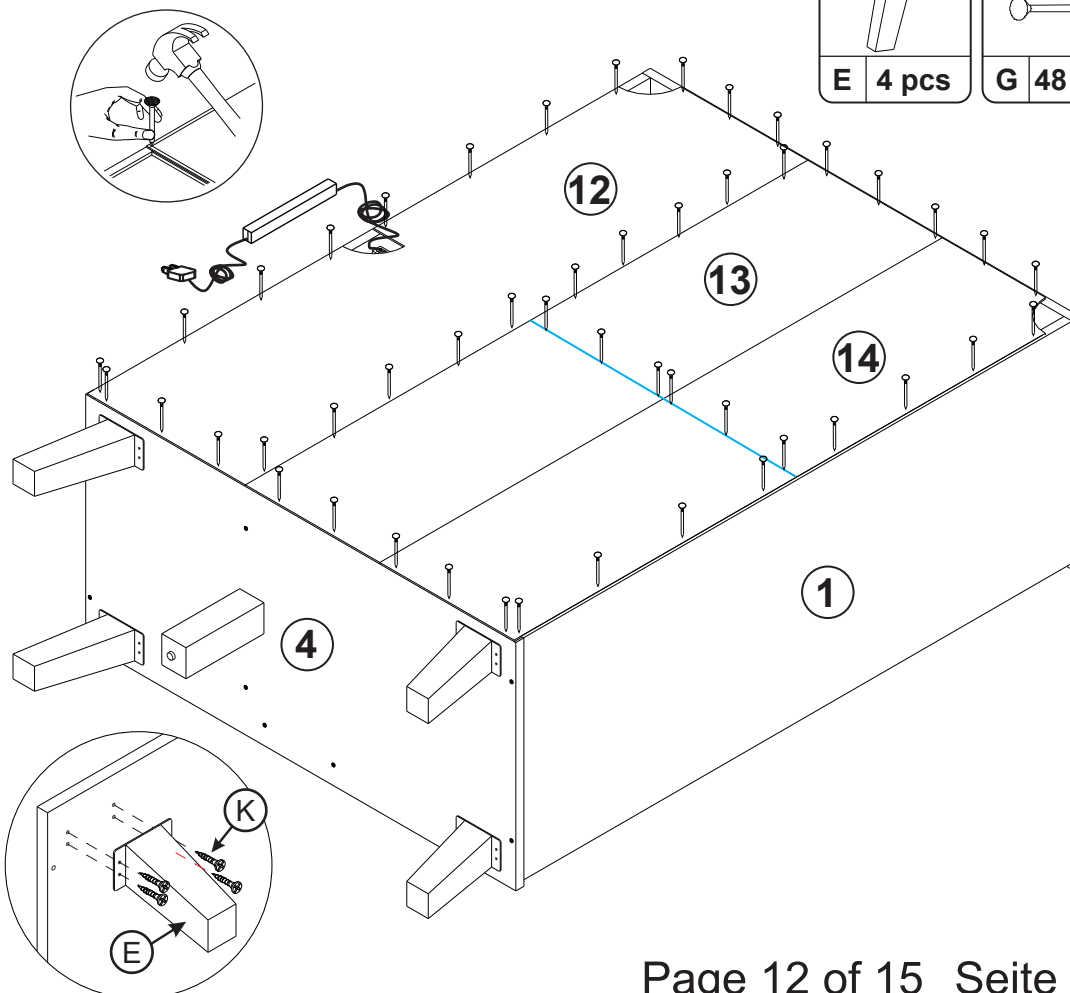
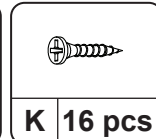
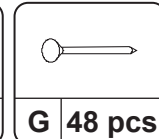
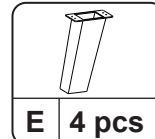
**9**

10

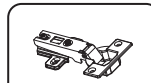

D 4 pcs

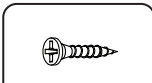

K 8 pcs

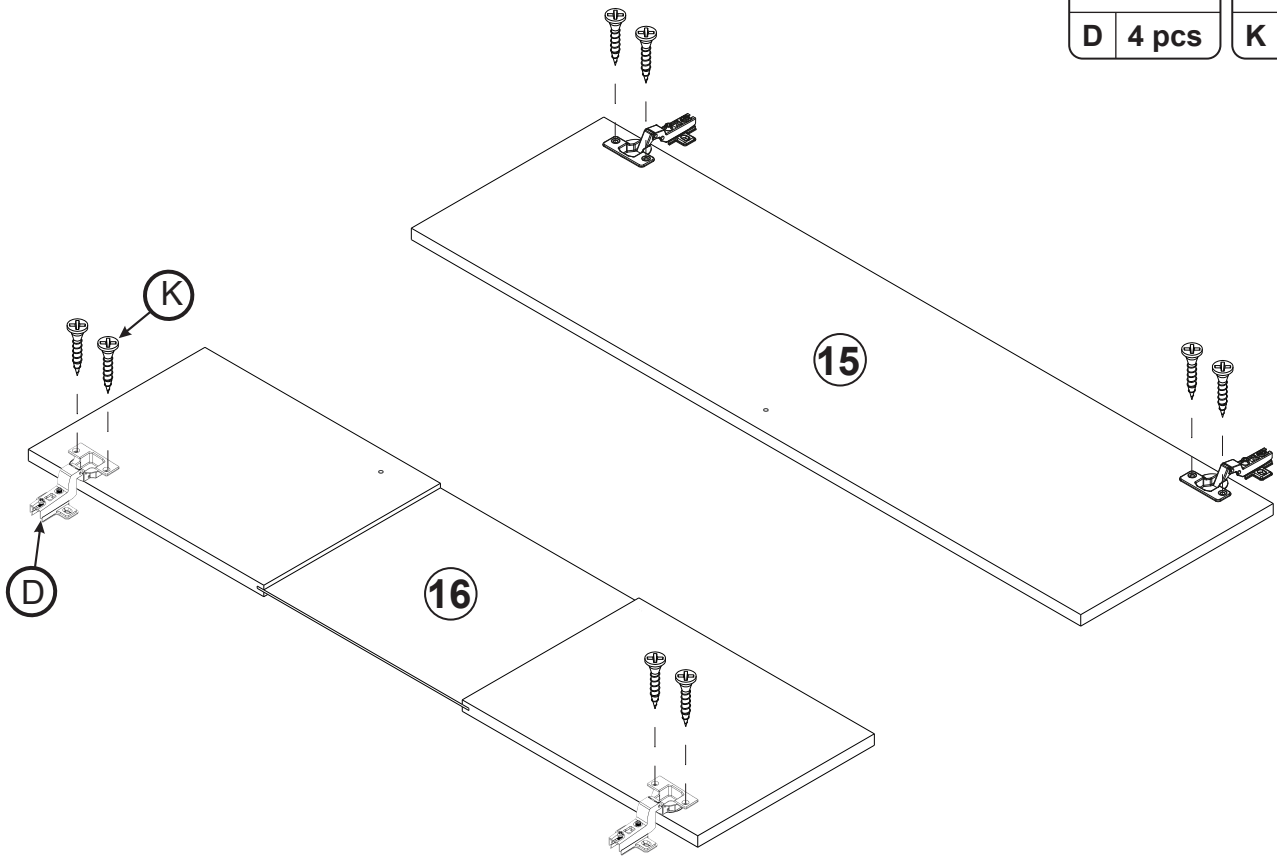

11



I 16 pcs

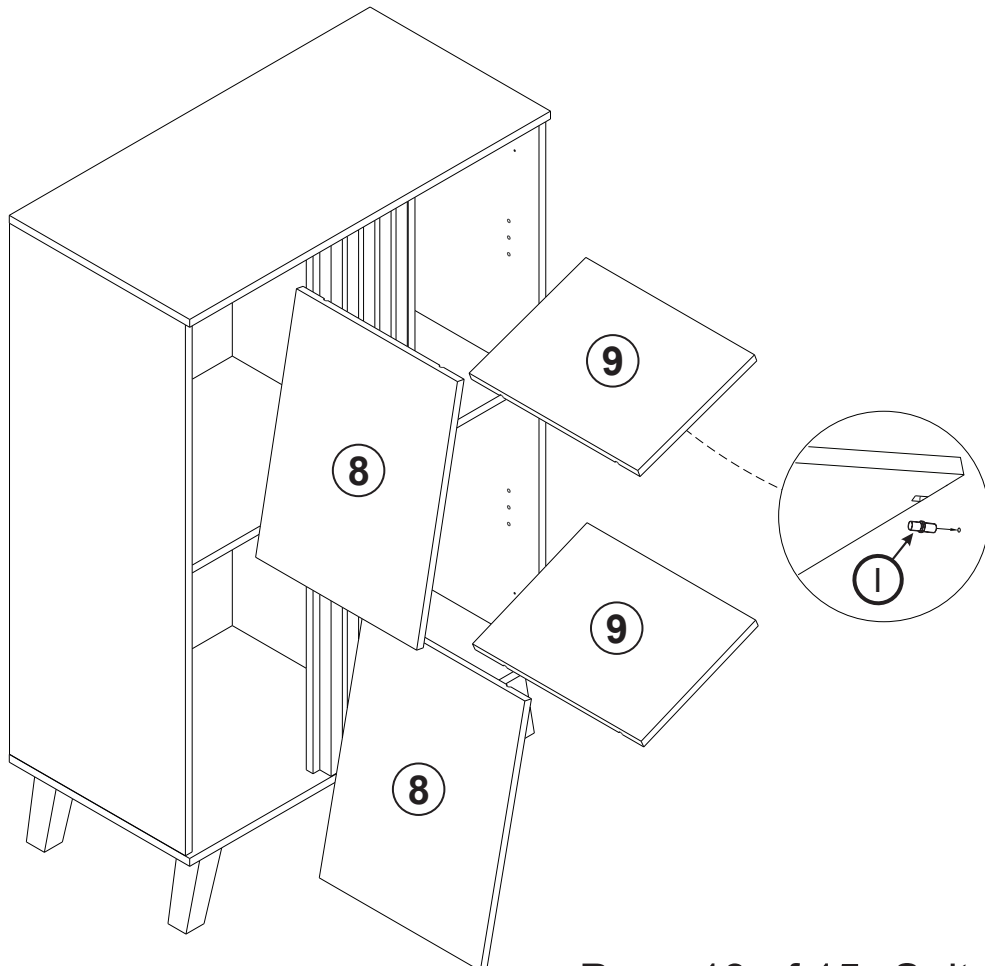

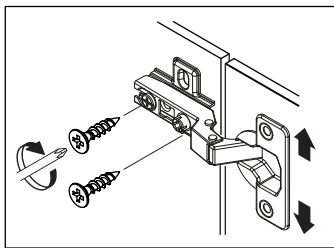
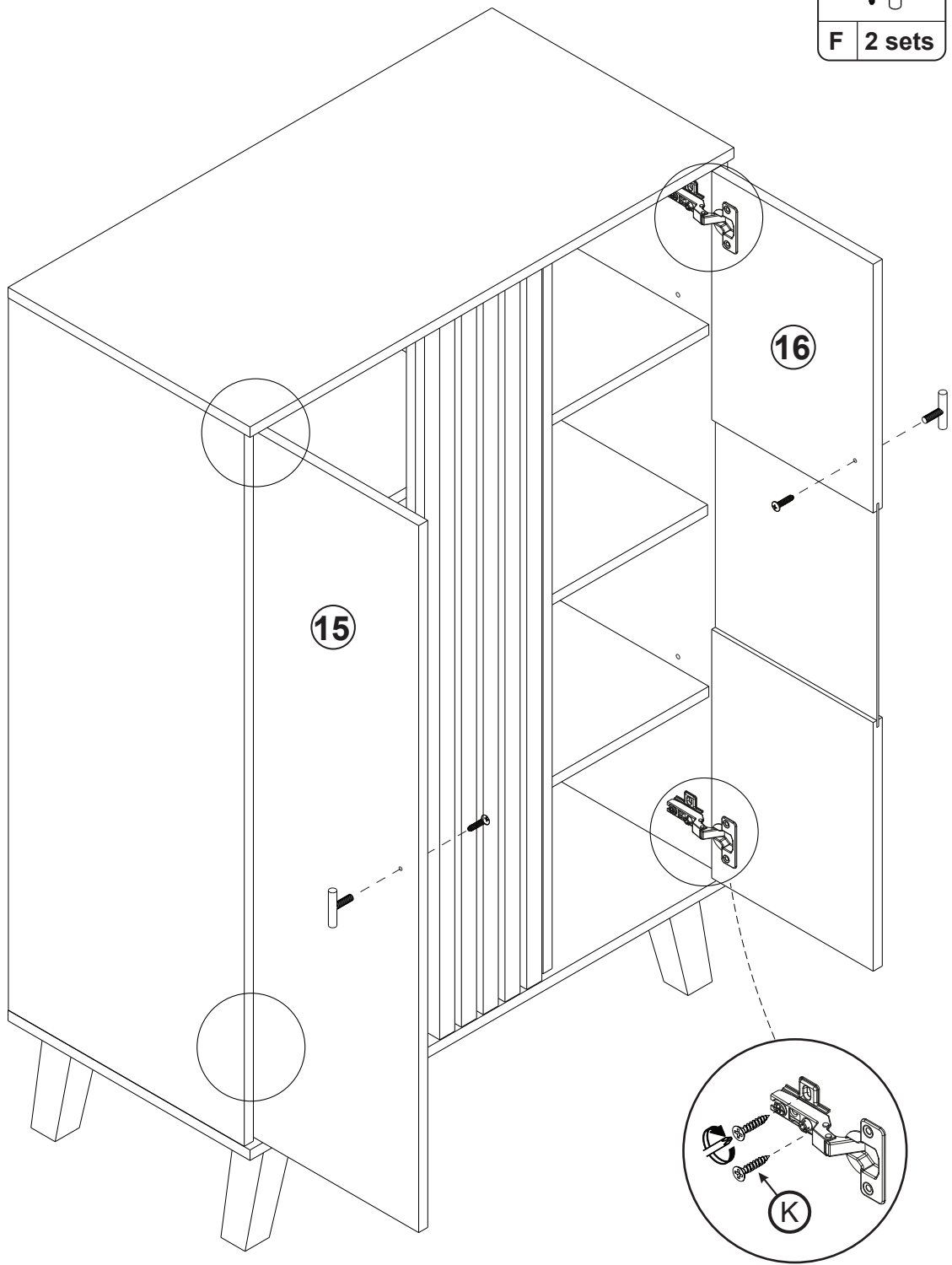
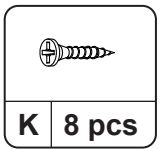
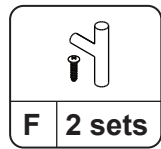

1.Adjustment Up or Down & Fix the screw after adjust
1.Nach oben oder unten anpassen und die Schraube nach der Einstellung festziehen

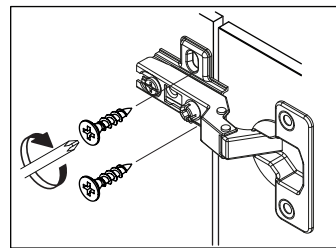

2.Fix the front screws
2. Befestigen Sie die vorderen Schrauben

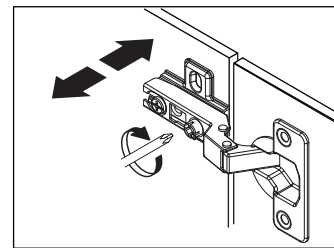

3.Lateral adjustment by screw adjusting
3.Seitenverstellung durch Schraubenverstellung

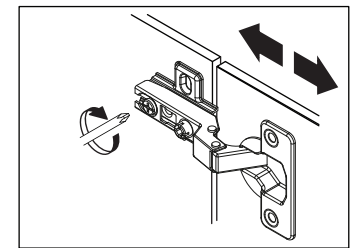

4.Front to Back by slacking the hinge arm mounting screw
4.Von vorne nach hinten, indem Sie die Befestigungsschraube des Scharnierarms lösen

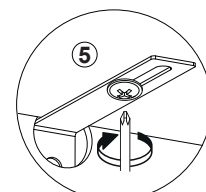
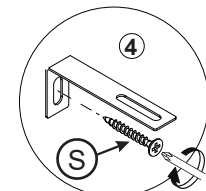
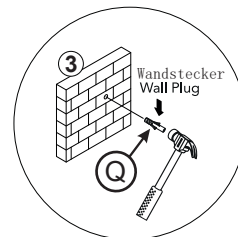
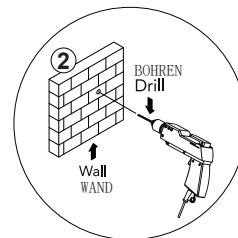
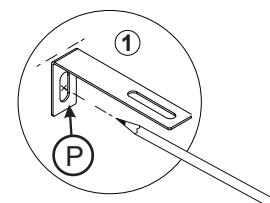
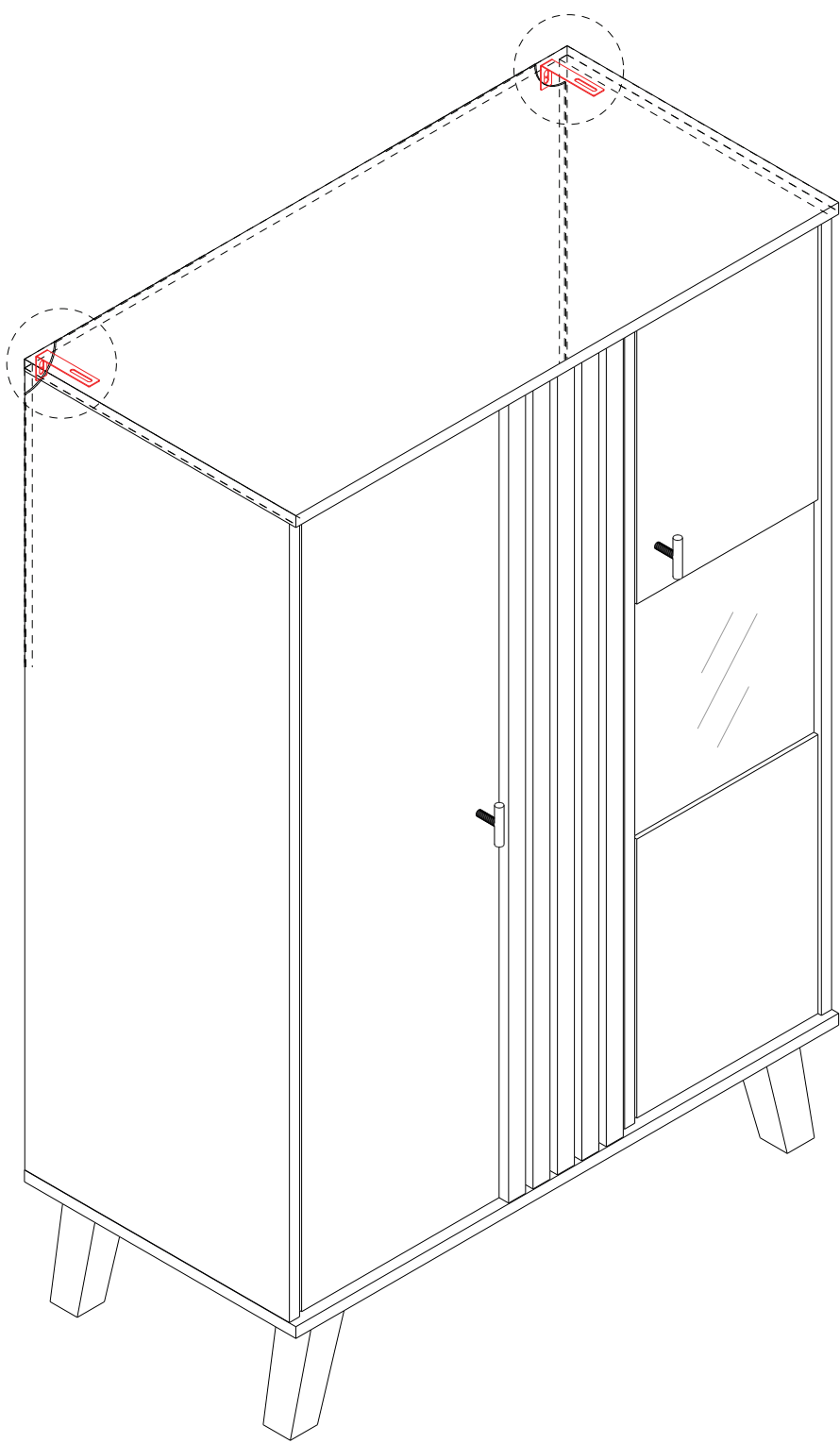
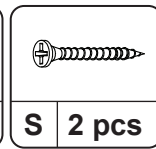
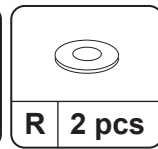
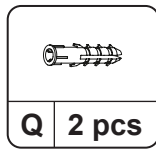
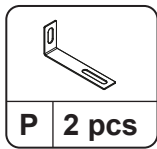
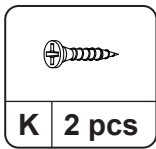

TIGHTEN THE SCREWS
SCHRAUBEN FESTZIEHEN