

# MONTAGEANLEITUNG

WF317827/WF317828/WF317829

## TIPPS

1. Bitte lesen Sie die Anweisungen vor der Montage sorgfältig durch. Diese Anweisungen enthalten wichtige Informationen, um eine korrekte Montage zu gewährleisten. Wir bemühen uns, Ihnen qualitativ hochwertige Produkte zu bieten. In seltenen Fällen, dass Ihr Produkt beschädigt ist, Teile fehlt oder Sie auf Probleme bei der Montage stoßen, wenden Sie sich damit bitte an unseren Kundendienst, wir werden Ihnen die beste Lösung so schnell wie möglich bieten. Um Ihr Problem schnell zu lösen, bitte stellen Sie uns einige Bilder zur Verfügung, die das Produktproblem deutlich widerspiegeln können. Vielen Dank !
2. Setzen Sie die Schrauben in die Löcher ein und ziehen Sie die Schrauben an, aber nicht zu fest, 70 % ~ 80 % ist genug, und ziehen Sie schließlich alle Schrauben an. Wenn einige Schrauben nicht mit den Löchern ausgerichtet sind oder die Montage einiger Teile schwierig ist, stellen Sie bitte den Straffheitsgrad der Schrauben um.
3. Es wird empfohlen, dass 2 Personen das Produkt installieren.

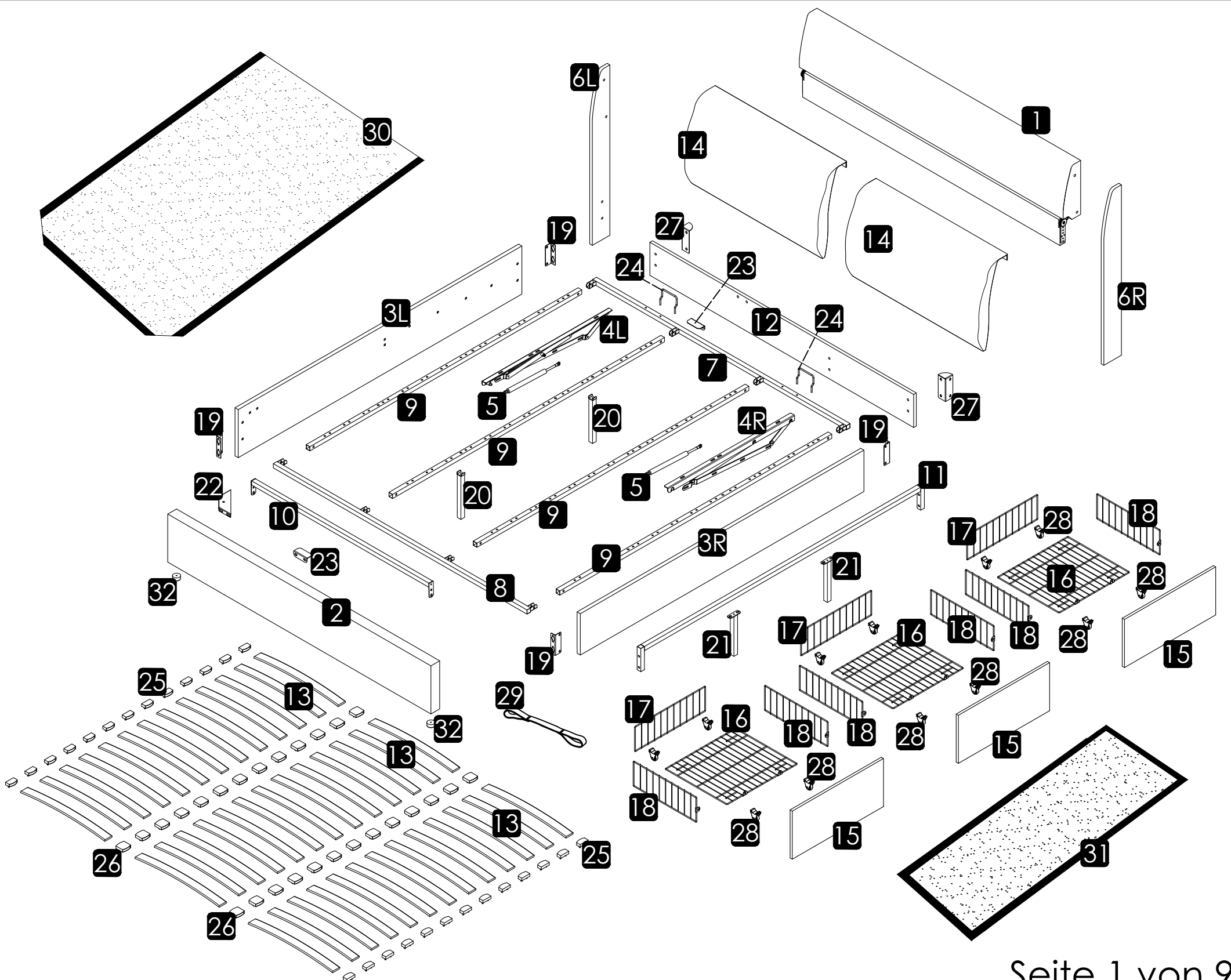
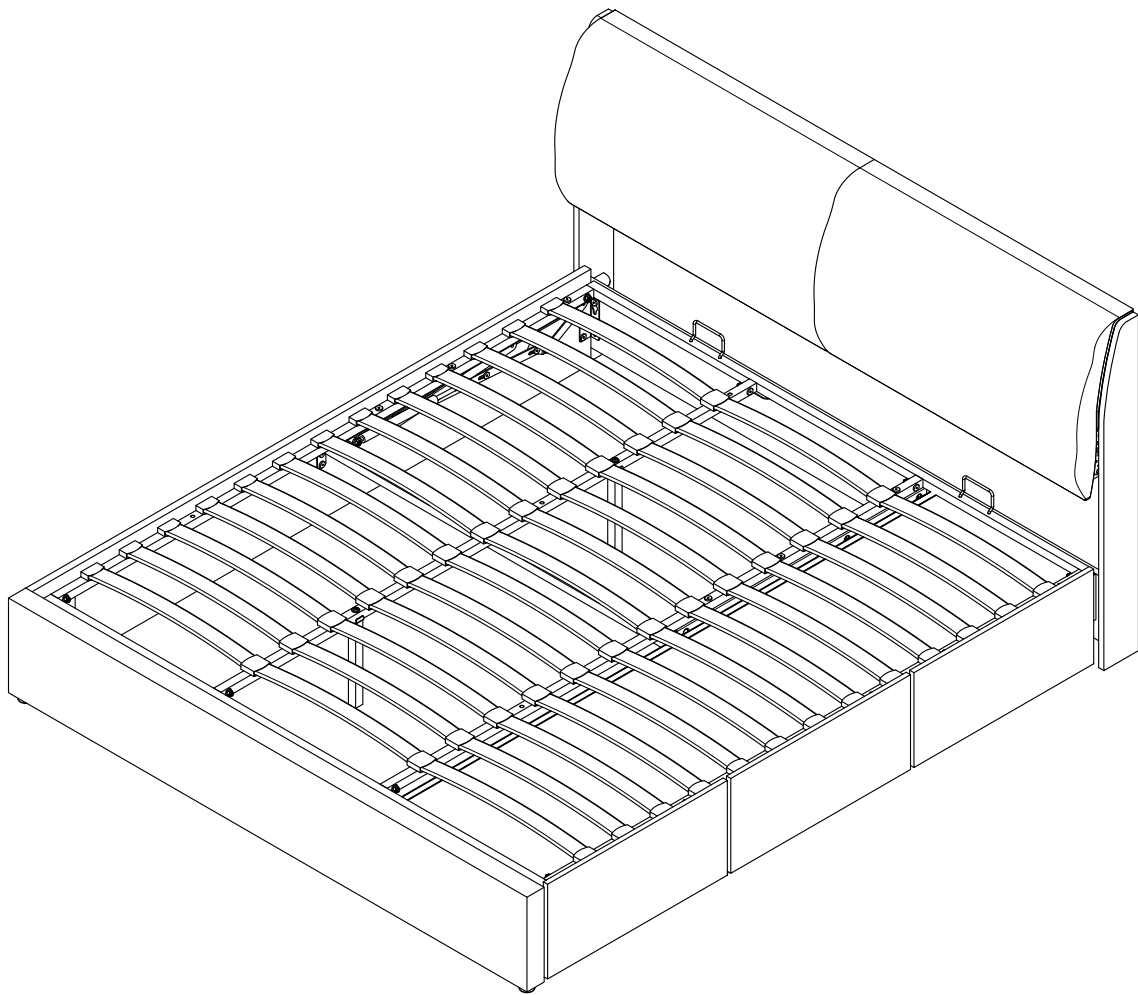

## WICHTIGER HINWEIS

### OTTOMISCHE BETRIEBSANLEITUNGEN

Sobald Ihr Bettrahmen komplett montiert ist, funktioniert der Lattenrost nicht richtig, es sei denn, eine Matratze wird auf dem Lattenrost platziert. Legen Sie die Matratze auf den Lattenrost, wenn die Matratze sich in geschlossener Position befindet.

**BITTE BEACHTEN SIE:** Es braucht viel Kraft, um die erste Bewegung der Hydraulikstange zu machen. Dies ist ein Konstruktionsmerkmal des Produkts, so dass es nicht verschleißt. Je näher die Hydraulikstange geschlossen ist, desto leichter ist es zu bewegen. Wenn die Hydraulikstange am meisten geschlossen ist, schließt er unter seinem eigenen Gewicht vollständig. Achten Sie beim ersten Absenken des Lattenrosts darauf, dass sie nicht ungleichmäßig an der Innenseite der Seitenschiene reibt. Wenn ja, ist die Bettmontage nicht ganz korrekt. Dies kann behoben werden, indem das Fußende des Bettes leicht nach links oder rechts bewegt wird, während das Kopfende still steht.

### KOLBEN

Die Kolben, die bei der Konstruktion dieses Produkts verwendet werden, sind extrem stark und können beim Abnehmen des Ottomans nicht von Hand bedient werden. Alle Kolben werden auf korrekten Druck und Betrieb geprüft, bevor sie an dem Lattenrost befestigt werden. Anfangs mag es scheinen, dass die Kolben beim Öffnen und Schließen der Hydraulikstange sehr steif sind.

### **DAS IST VOLLKOMMEN NORMAL**

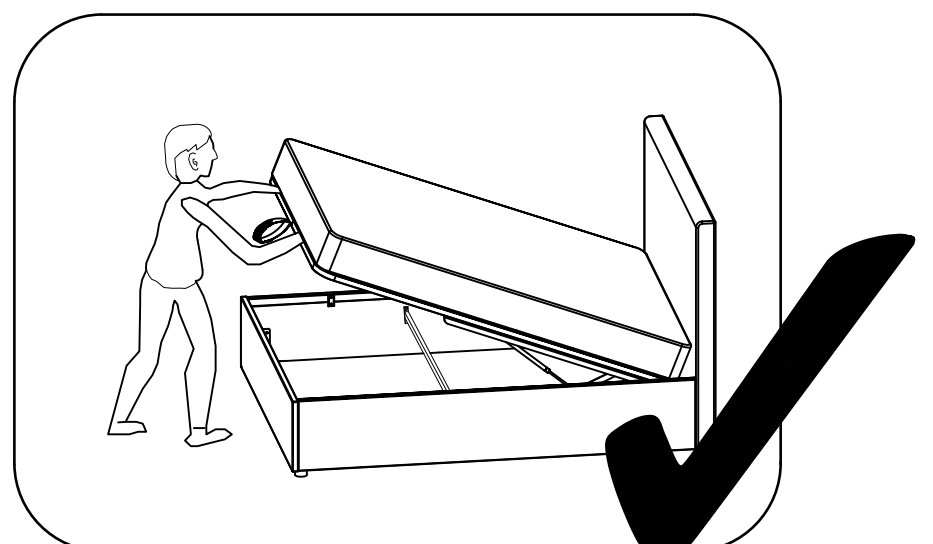
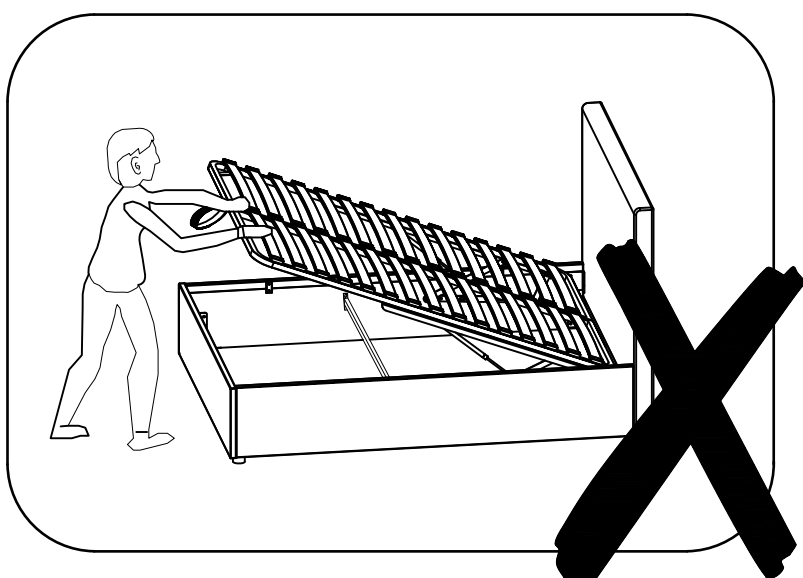

Wenn das Bett und die Matratze vollständig montiert sind, heben und senken Sie bitte die Hydraulikstange 4/5 Mal, um sicherzustellen, dass der Gaskolben vollständig geschmiert ist.



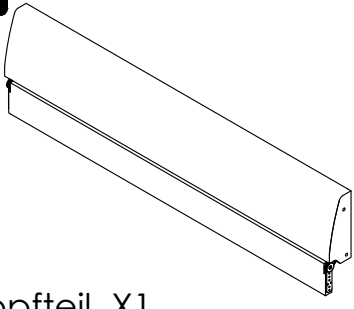
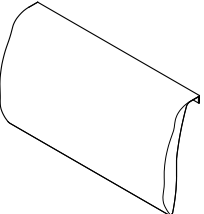
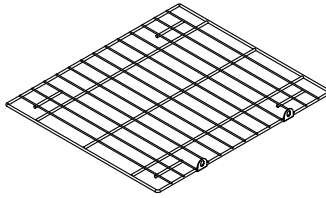
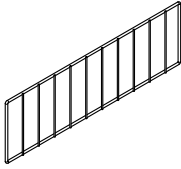
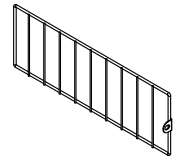



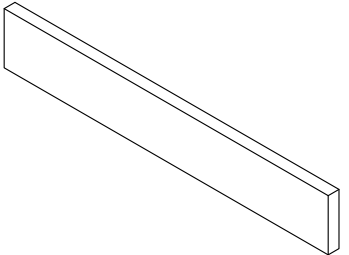
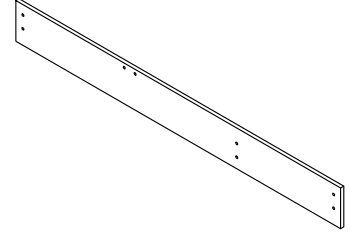
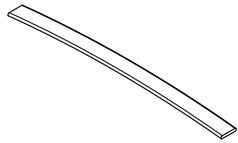
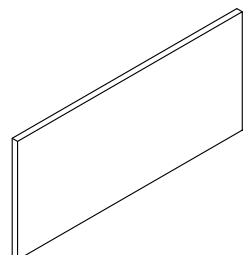
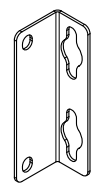

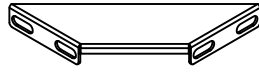
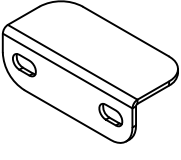
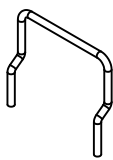
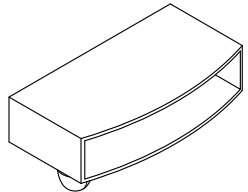
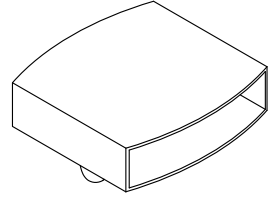
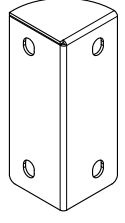
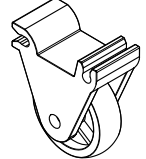
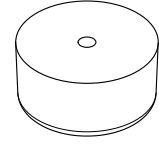
## Teileliste -WF317827

<p><b>1</b></p>  <p>Kopfteil X1</p>	<p><b>14</b></p>  <p>Kopfkissen X2</p>	<p><b>16</b></p>  <p>Eisengitter für Schubladen X3</p>	<p><b>17</b></p>  <p>Eisengitter für Schubladen X3</p>	<p><b>18</b></p>  <p>Eisengitter für Schubladen X6</p>
--	---	--	---	---

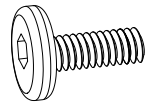
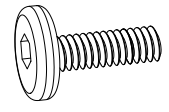
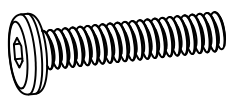
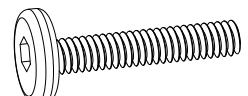

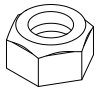
## Teileliste -WF317828

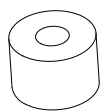
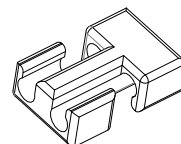
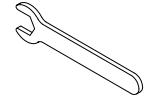
<p><b>2</b></p>  <p>Bettschwanz X1</p>	<p><b>12</b></p>  <p>Anschlussplatte X1</p>	<p><b>13</b></p>  <p>Lamelle X39</p>	<p><b>15</b></p>  <p>Frontplatte der Schublade X3</p>	<p><b>19</b></p>  <p>Eckhalterung aus Metall X4</p>
<p><b>20</b></p>  <p>Mittelfuß X2</p>	<p><b>22</b></p>  <p>Winkelhalter X1</p>	<p><b>23</b></p>  <p>Winkeleisen X2</p>	<p><b>24</b></p>  <p>Matratzenstopper X2</p>	<p><b>25</b></p>  <p>Lamellenkappen aus Kunststoff X26</p>
<p><b>26</b></p>  <p>Mittlere Lamellenkappen X13</p>	<p><b>27</b></p>  <p>Eckhalterung aus Metall X2</p>	<p><b>28</b></p>  <p>Rad X12</p>	<p><b>32</b></p>  <p>Bettfuß X2</p>	

## Hardwareliste-WF317828

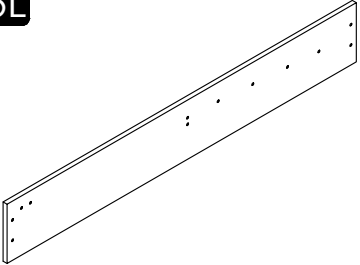
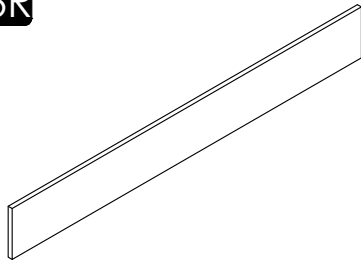
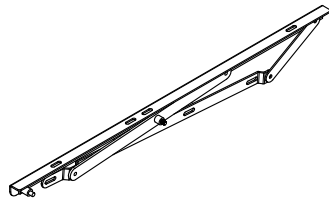
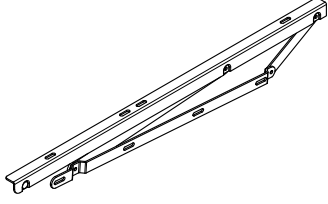
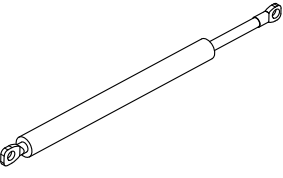

 <p><b>A</b> M8x16mm Bolt 12pcs</p>	 <p><b>B</b> M8x20mm Bolt 40pcs</p>	 <p><b>C</b> M8x30mm Bolt 8pcs</p>	 <p><b>D</b> M8x40mm Bolt 22pcs</p>	 <p><b>E</b> M6x35mm Bolt 2pcs</p>
 <p><b>F</b> M8 Nuss 18pcs</p>	 <p><b>G</b> Flache Unterlegscheibe 18pcs</p>	 <p><b>H</b> Kunststoffscheibe 8pcs</p>	 <p><b>J</b> Bajonett 24pcs</p>	 <p><b>K</b> Schraubenschlüssel 1pc</p>
 <p><b>L</b> Inbusschlüssel 1pc</p>	 <p><b>M</b> Schraube (4.0x40mm) 2pcs</p>			

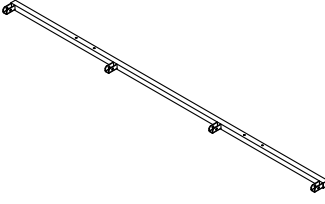
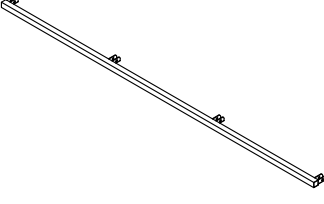
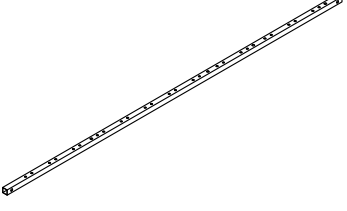
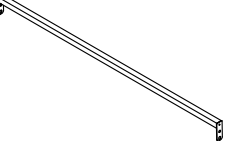
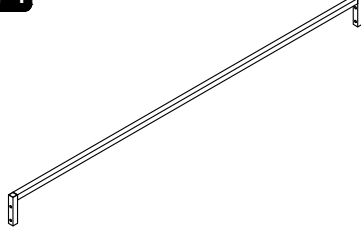
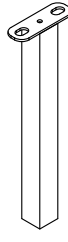
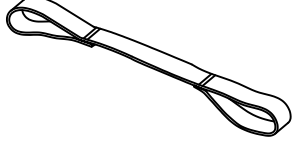
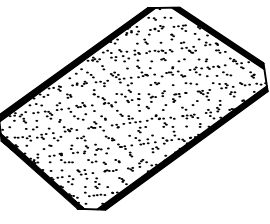
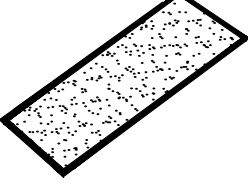
# Teileliste -WF317829

<b>3L</b>  Seitenschiene-LH X1	<b>3R</b>  Seitenschiene-RH X1	<b>4L</b>  Hebemechanismus-LH X1	<b>4R</b>  Hebemechanismus-RH X1	<b>5</b>  Gasfeder X2
<b>6L</b>  Bein des Kopfbretts X1	<b>6R</b>  Bedhead column X1	<b>7</b>  Vordere Querleiste X1	<b>8</b>  Hintere Querstange X1	<b>9</b>  Side Rails for Metal Slat Frame X4
<b>10</b>  Zentrale Stützschiene X1	<b>11</b>  Seitenrohr X1	<b>21</b>  Fuß X2	<b>29</b>  Fabric Handle X1	<b>30</b>  Fabric Base Cover X1
<b>31</b>  Fabric Cover X1				

**Achtung:** Ziehen Sie die Schrauben nicht fest, bevor Sie die gesamte Installation abschließen. Wenn Sie Schwierigkeiten mit dem Installationsprozess haben, zögern Sie nicht, uns zu kontaktieren.



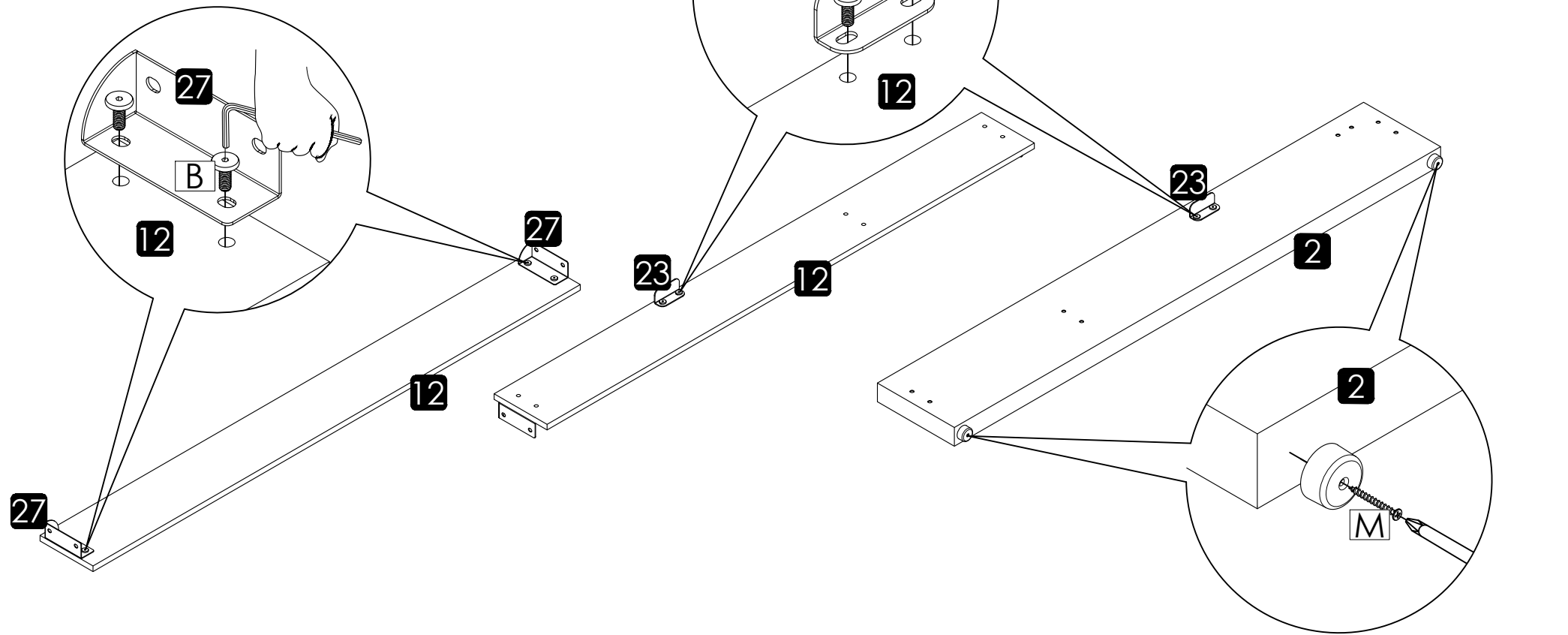

## Schritt 1

- B**  8pcs
- M**  2pcs
- L**  1pc







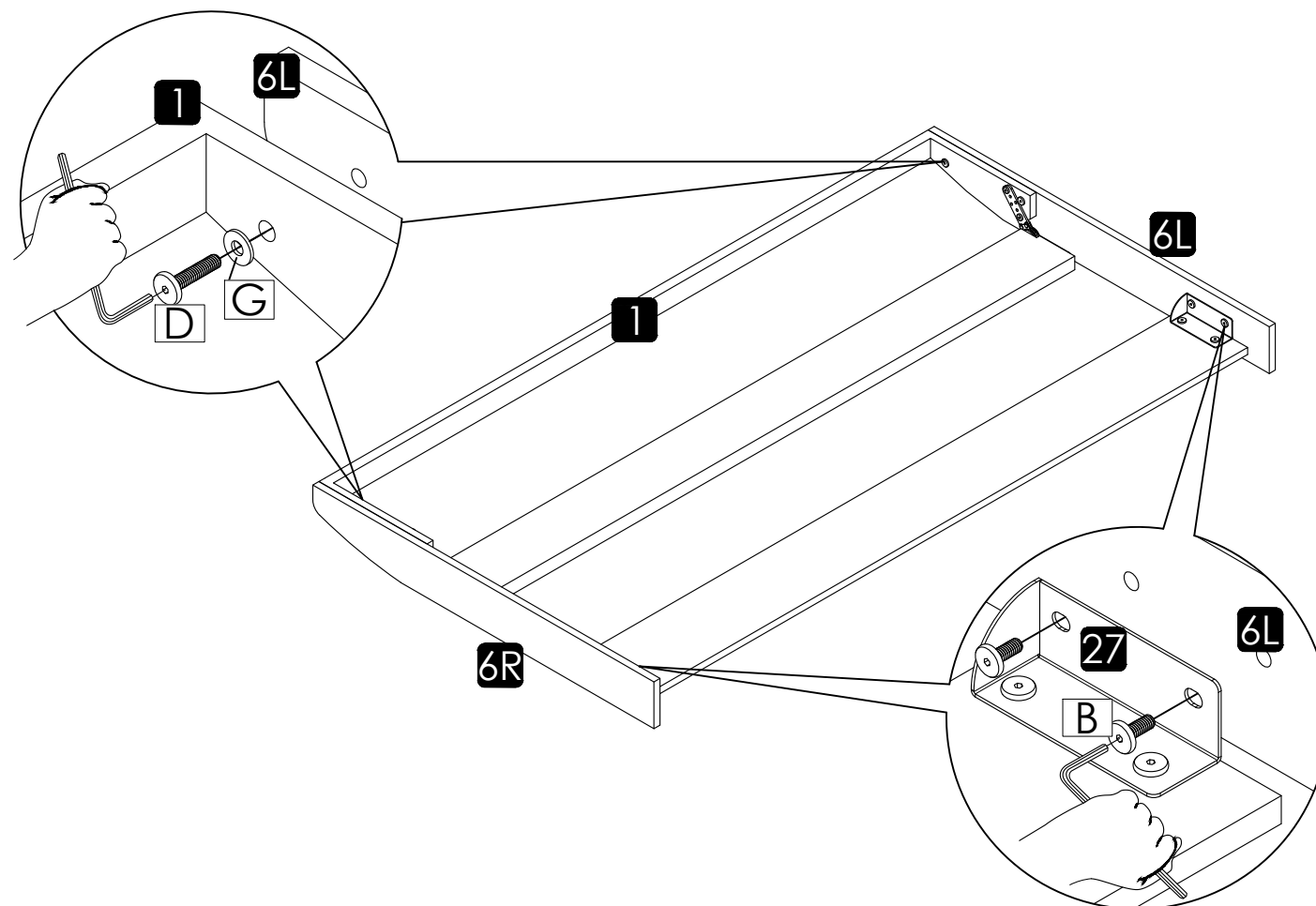

## Schritt 2

- B**  4pcs
- D**  4pcs
- G**  4pcs
- L**  1pc



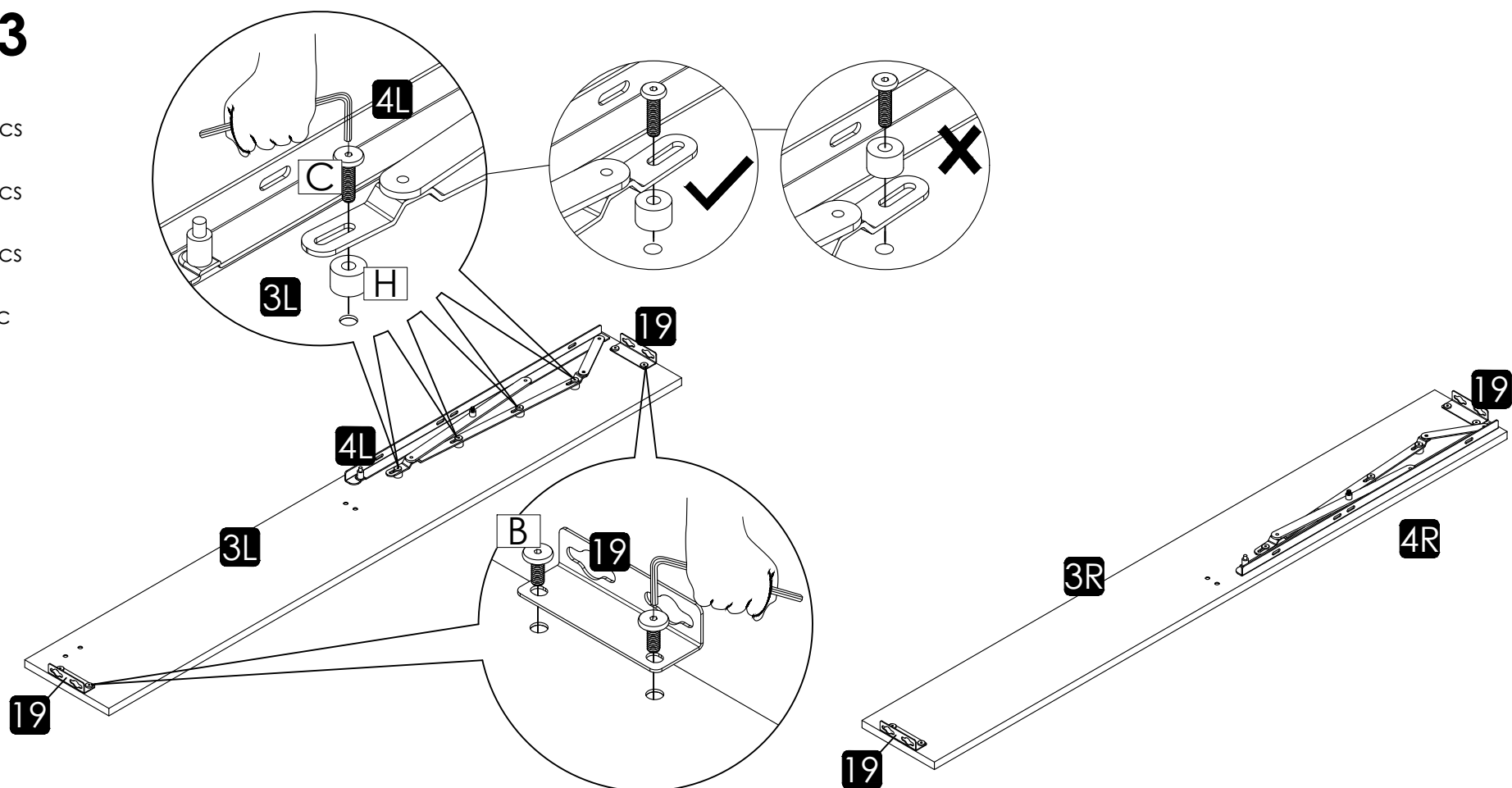

## Schritt 3

- B**  8pcs
- C**  8pcs
- H**  8pcs
- L**  1pc





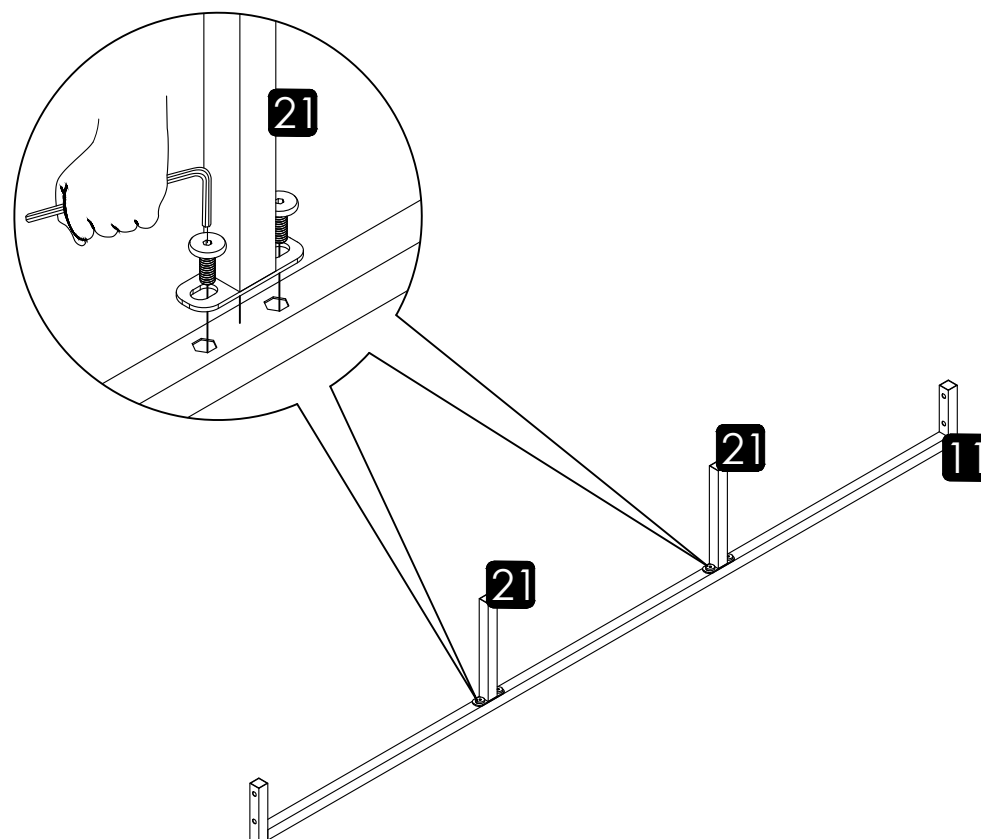

## Schritt 4

- B**  4pcs
- L**  1pc



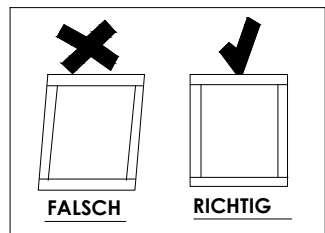
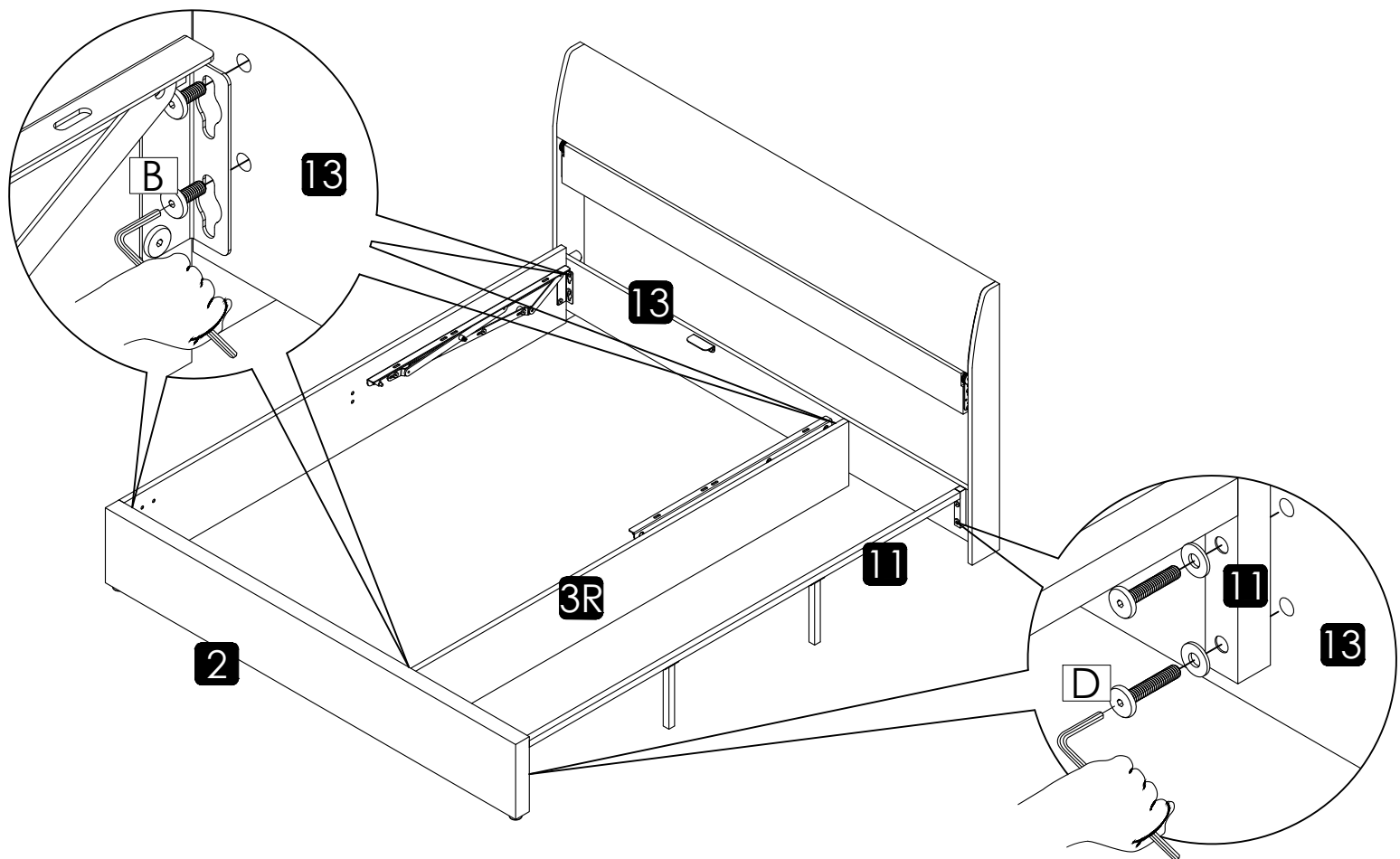

## Schritt 5

- B**  8pcs
- D**  4pcs
- G**  4pcs
- L**  1pc



## Schritt 6



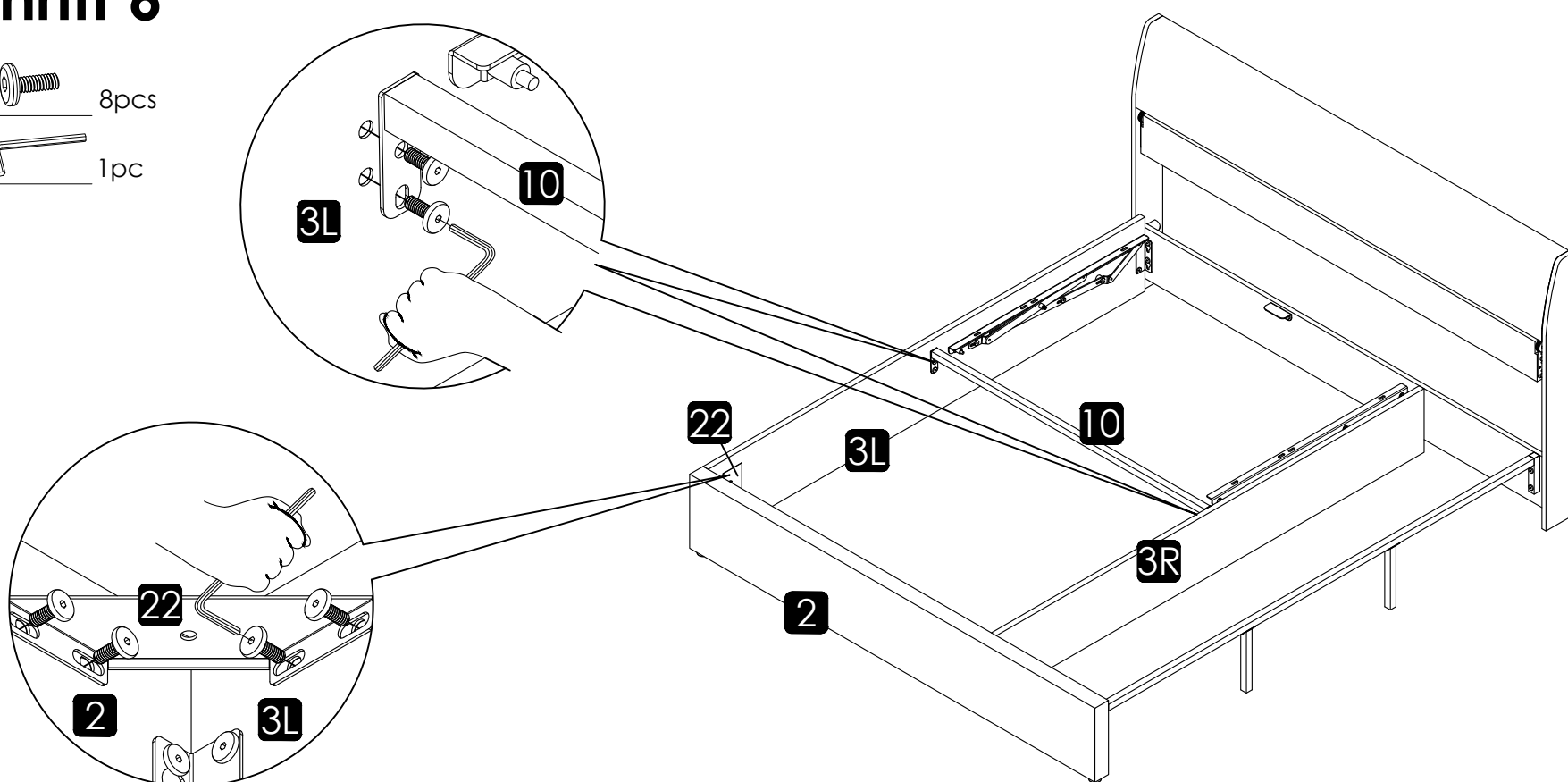

- B**  8pcs
- L**  1pc

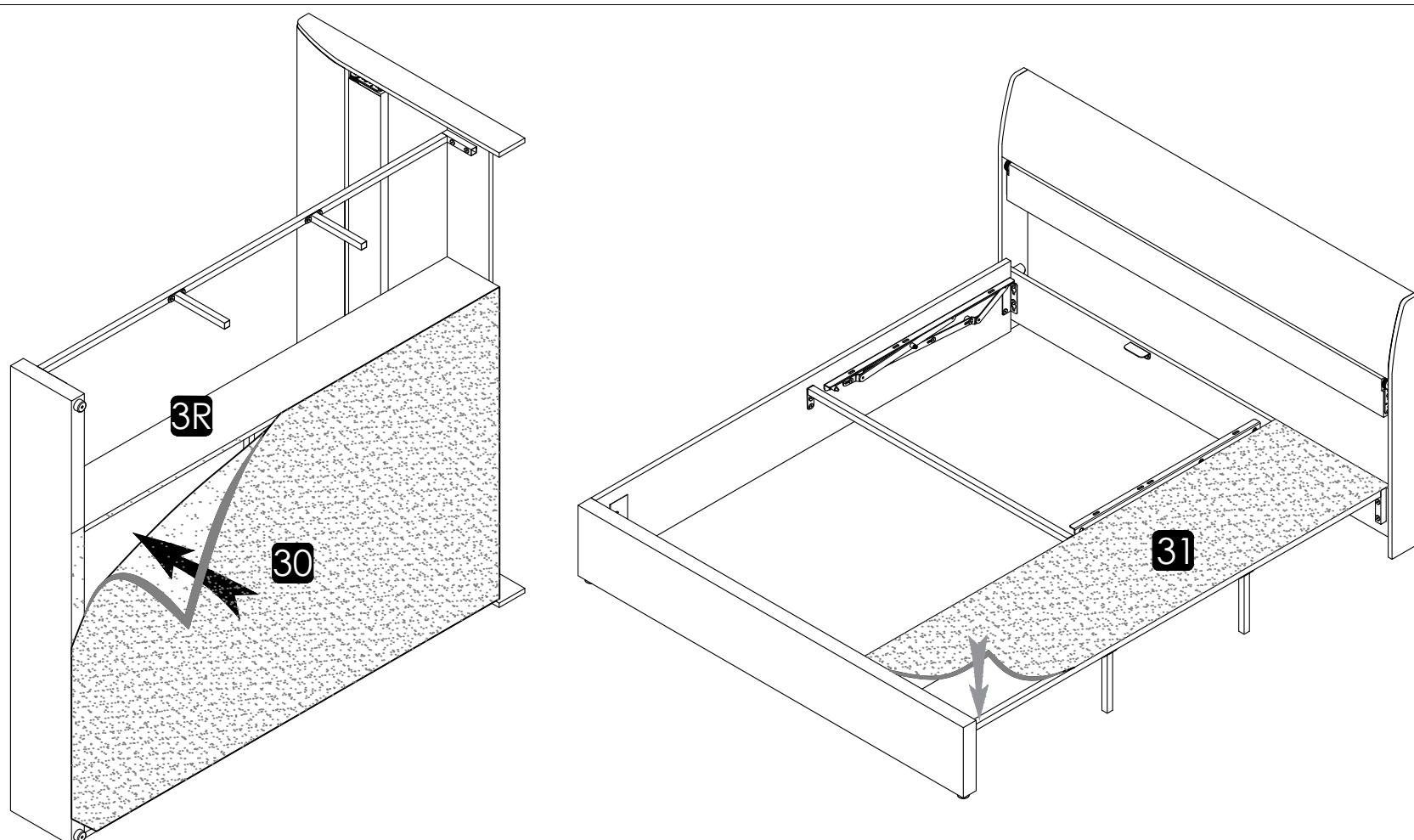

## Schritt 7

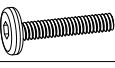





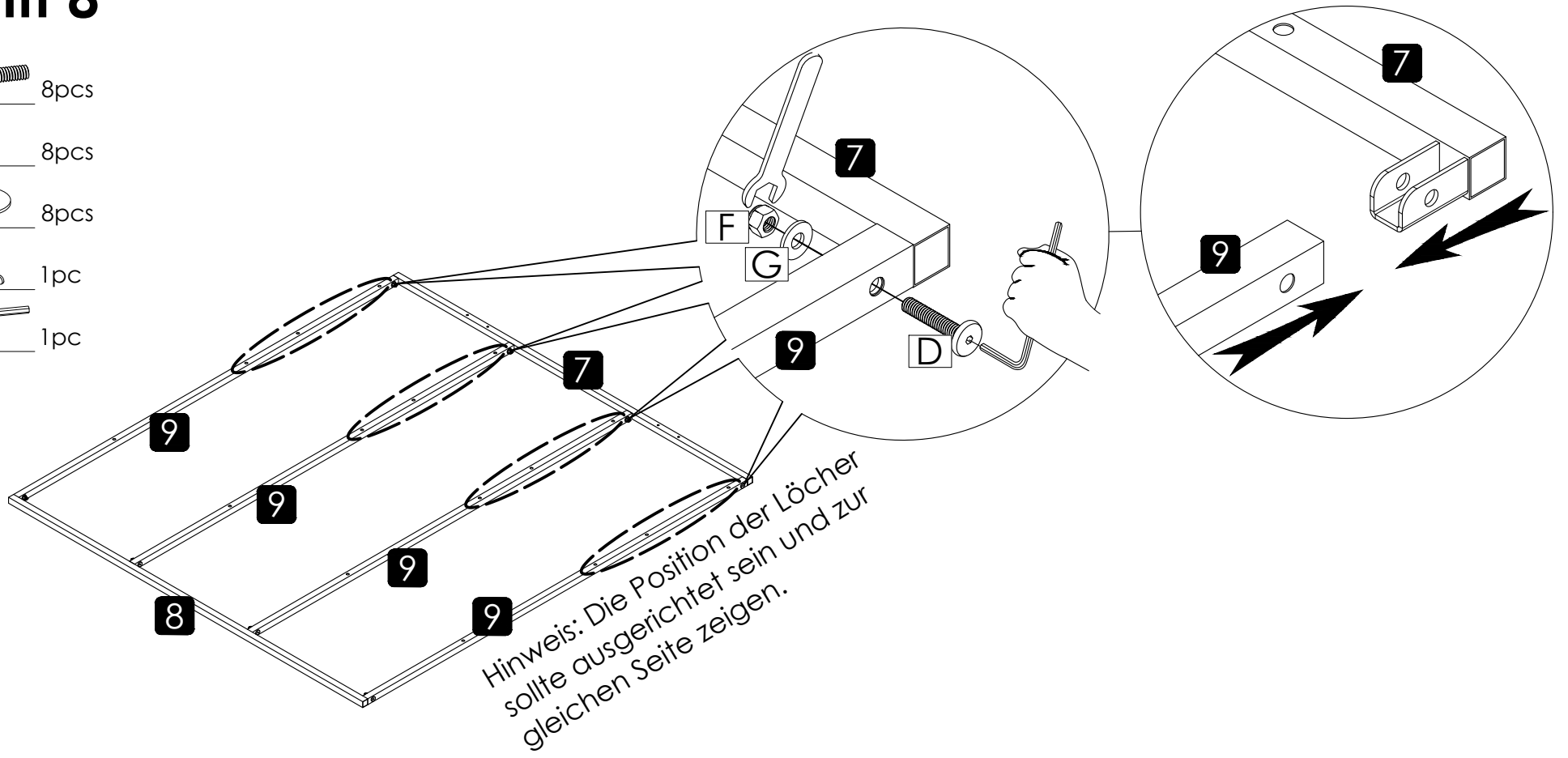

## Schritt 8

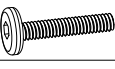
- D**  8pcs
- F**  8pcs
- G**  8pcs
- K**  1pc
- L**  1pc



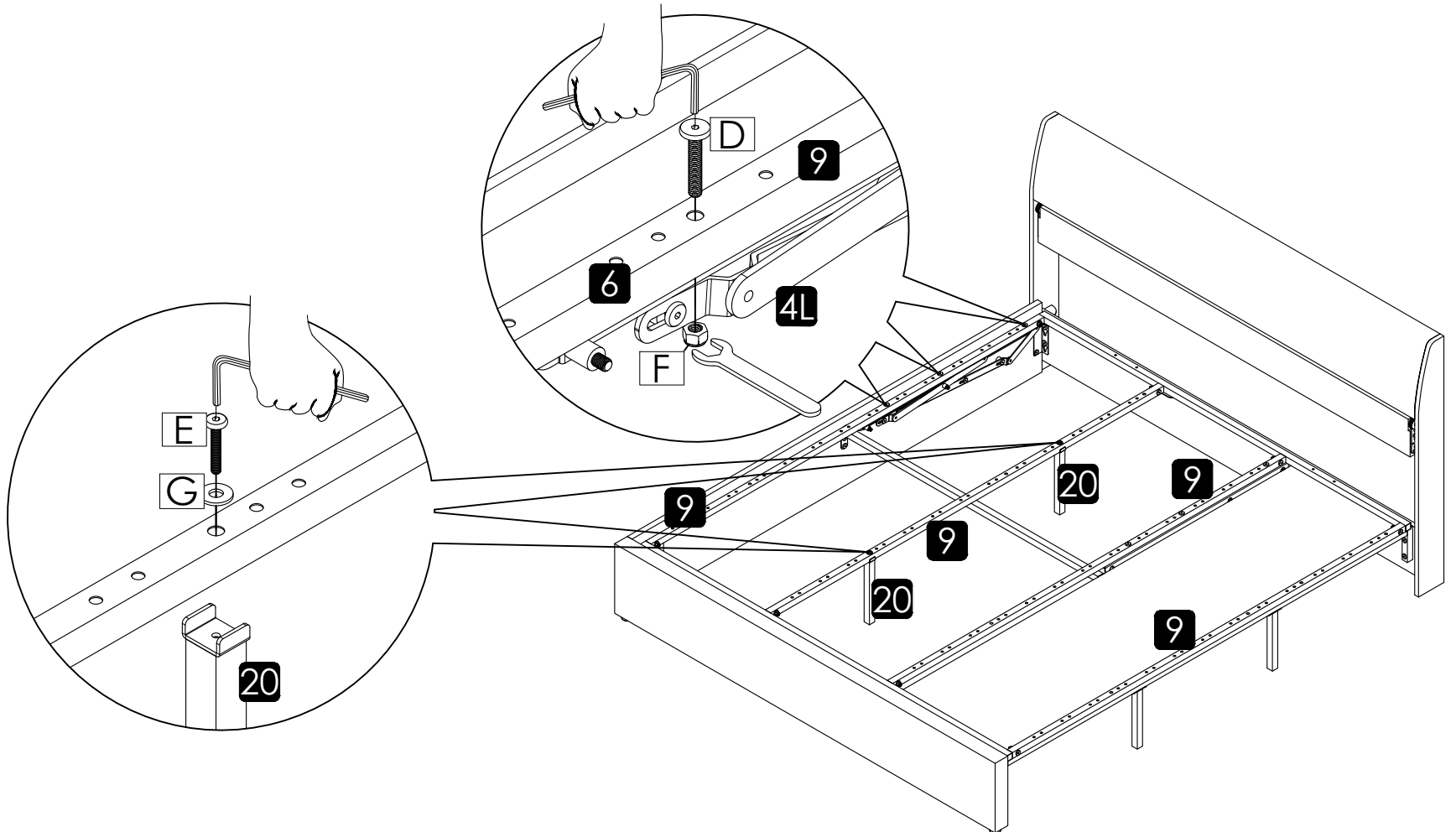

## Schritt 9

- D**  6pcs
- E**  2pcs
- F**  6pcs
- G**  2pcs
- K**  1pc
- L**  1pc



## Schritt 10

- 25**  26pcs
- 26**  26pcs

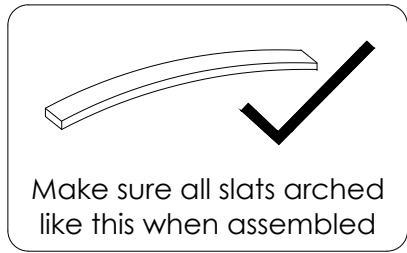
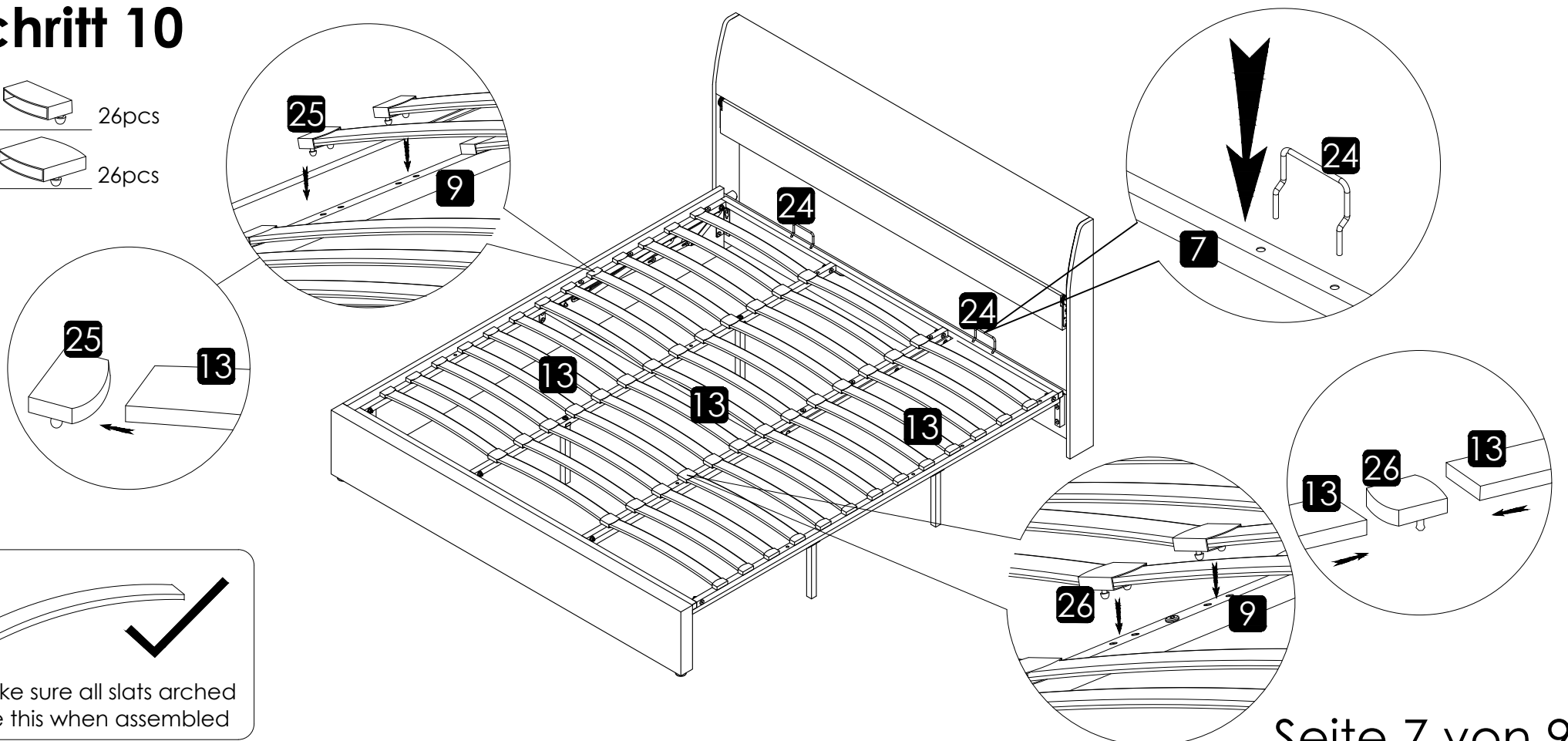

# Schritt 11

F  4pcs

K  1pc

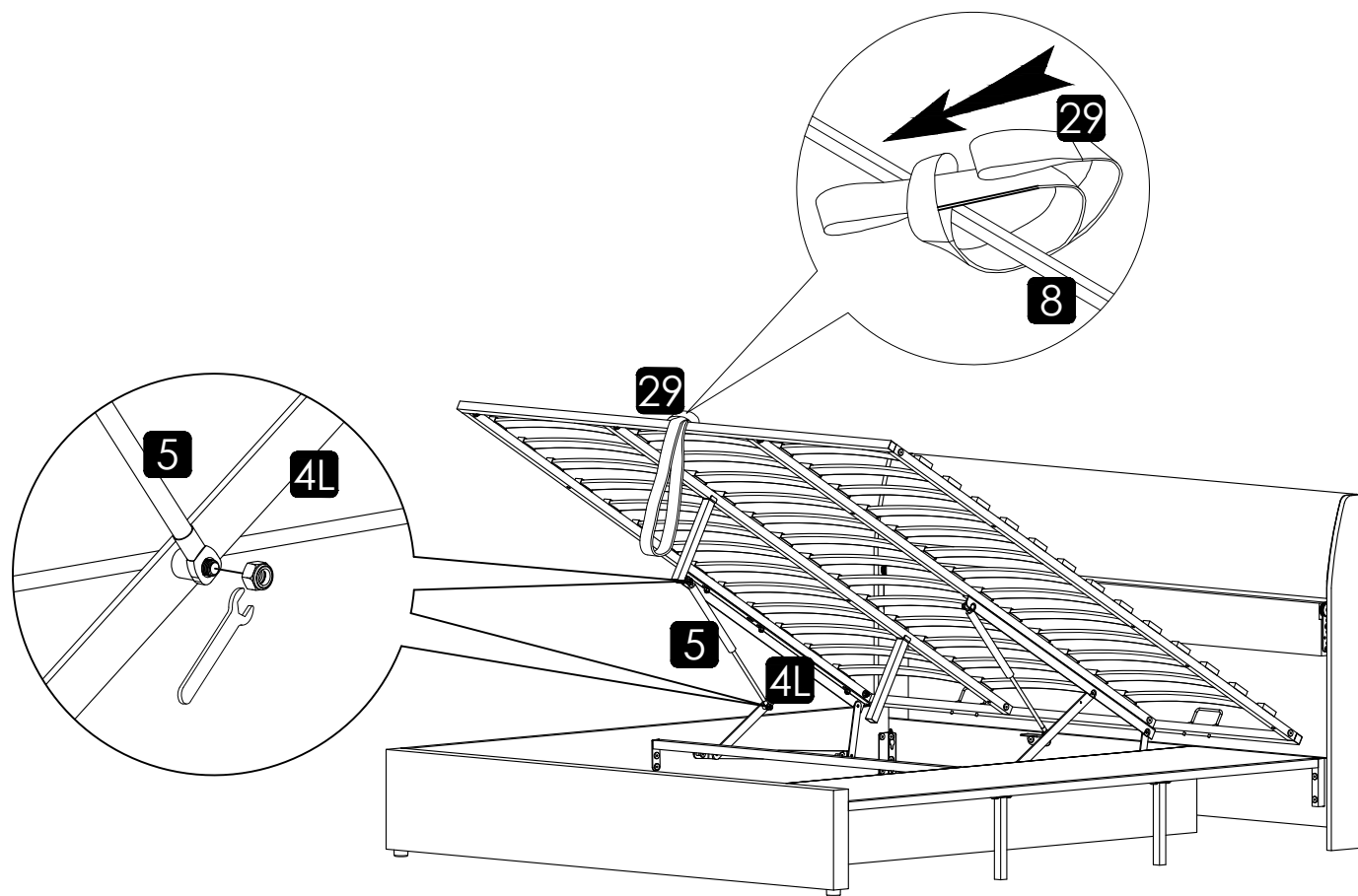

# Schritt 12

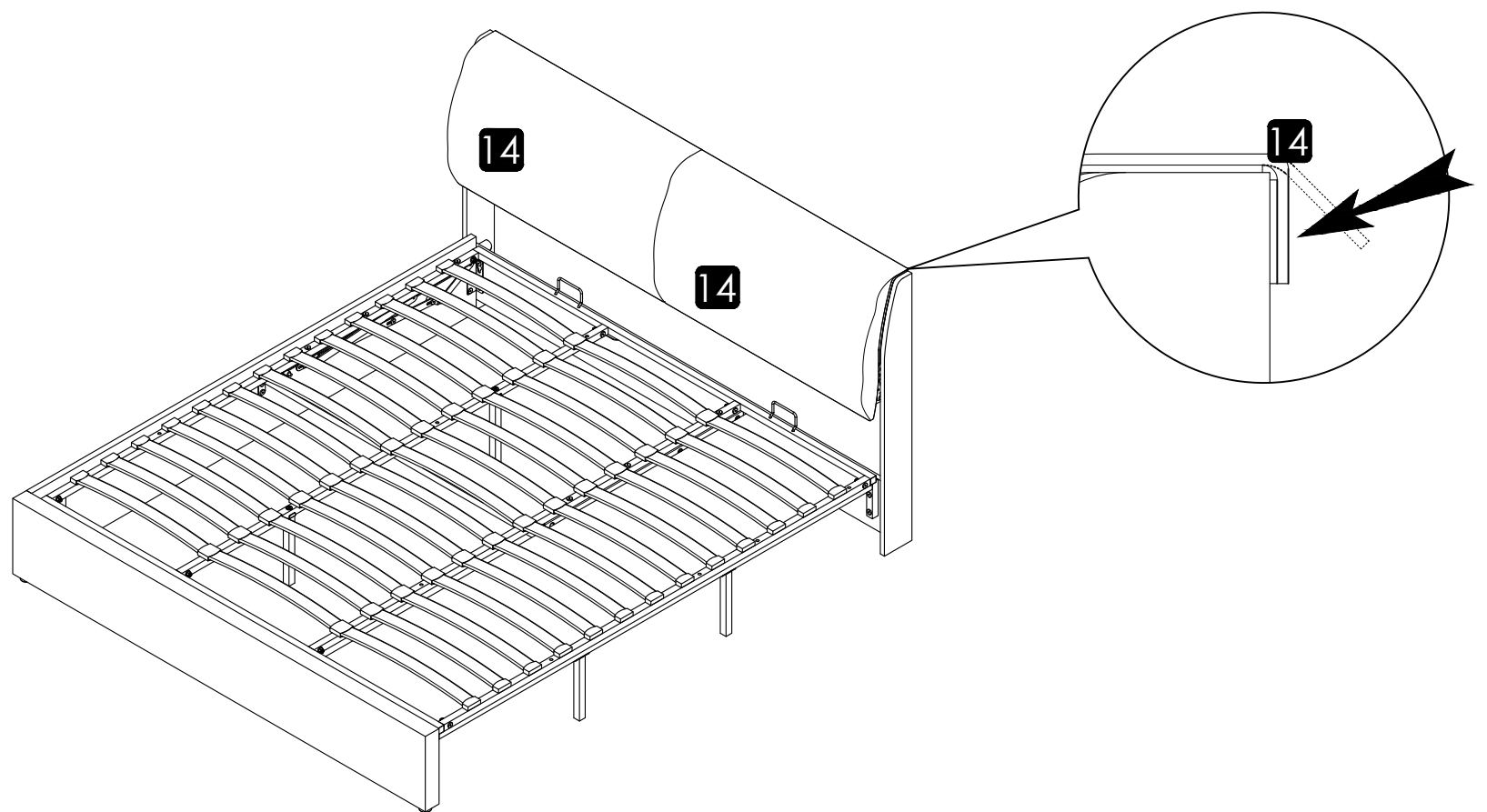

# Schritt 13

J  24pcs

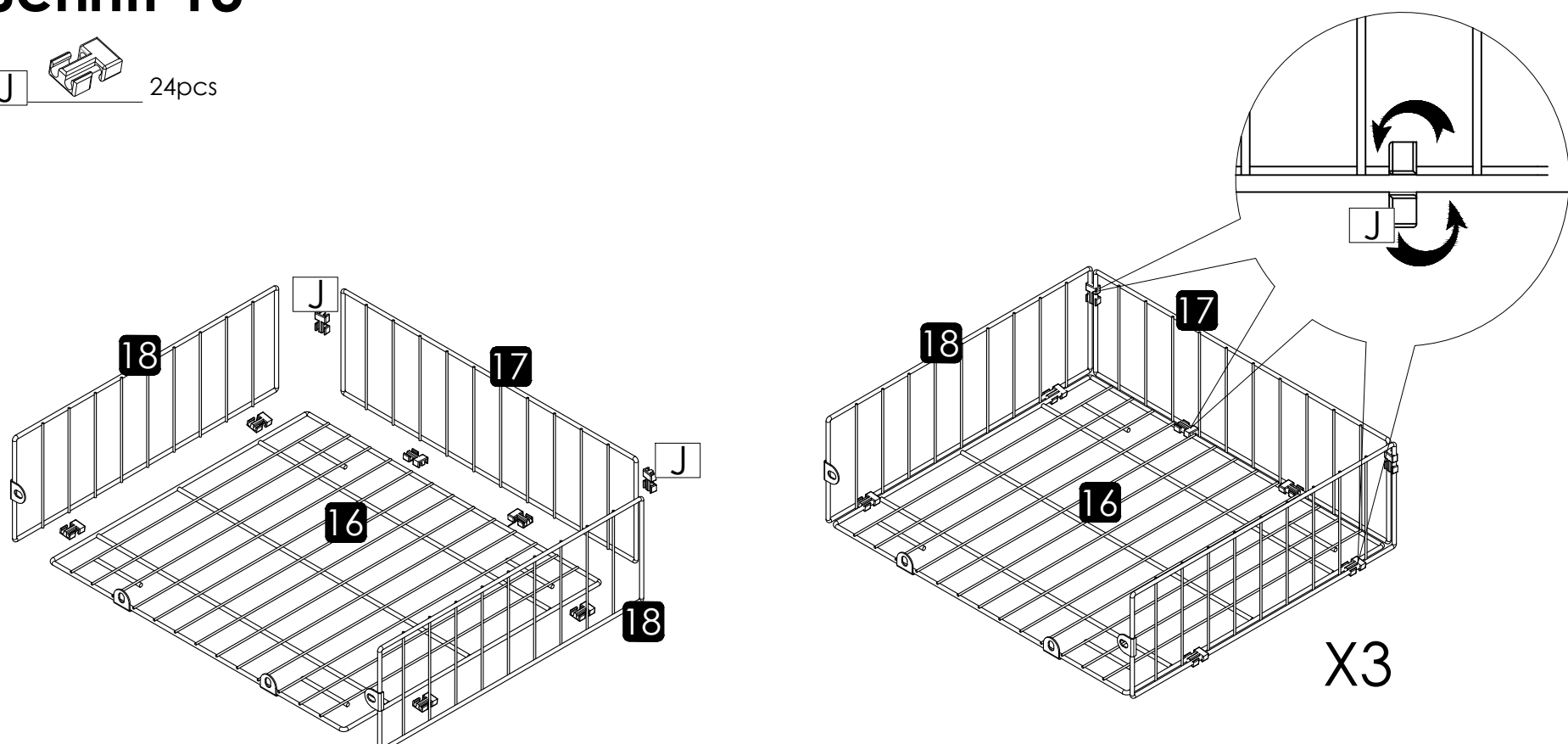



## Schritt 14

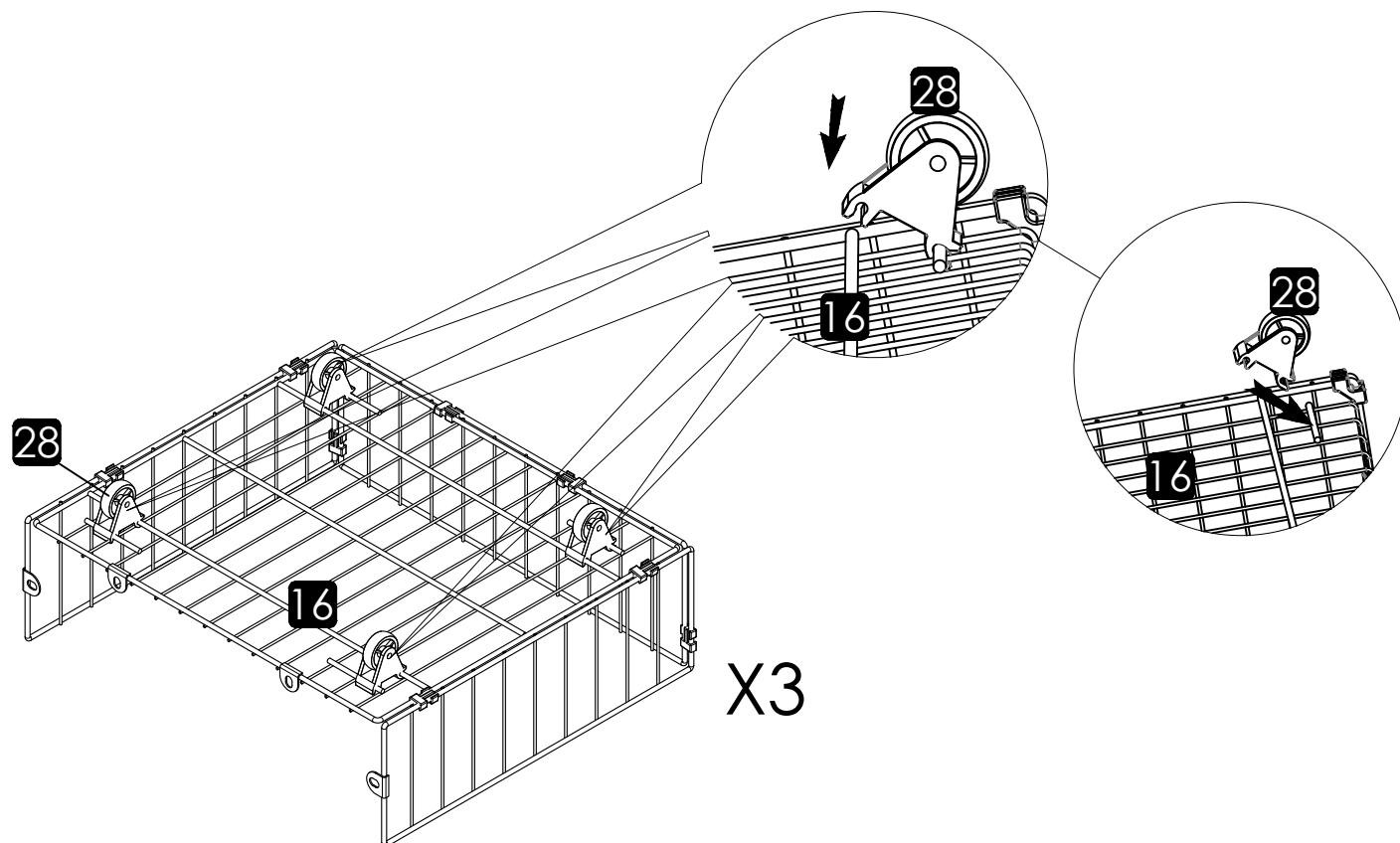

## Schritt 15

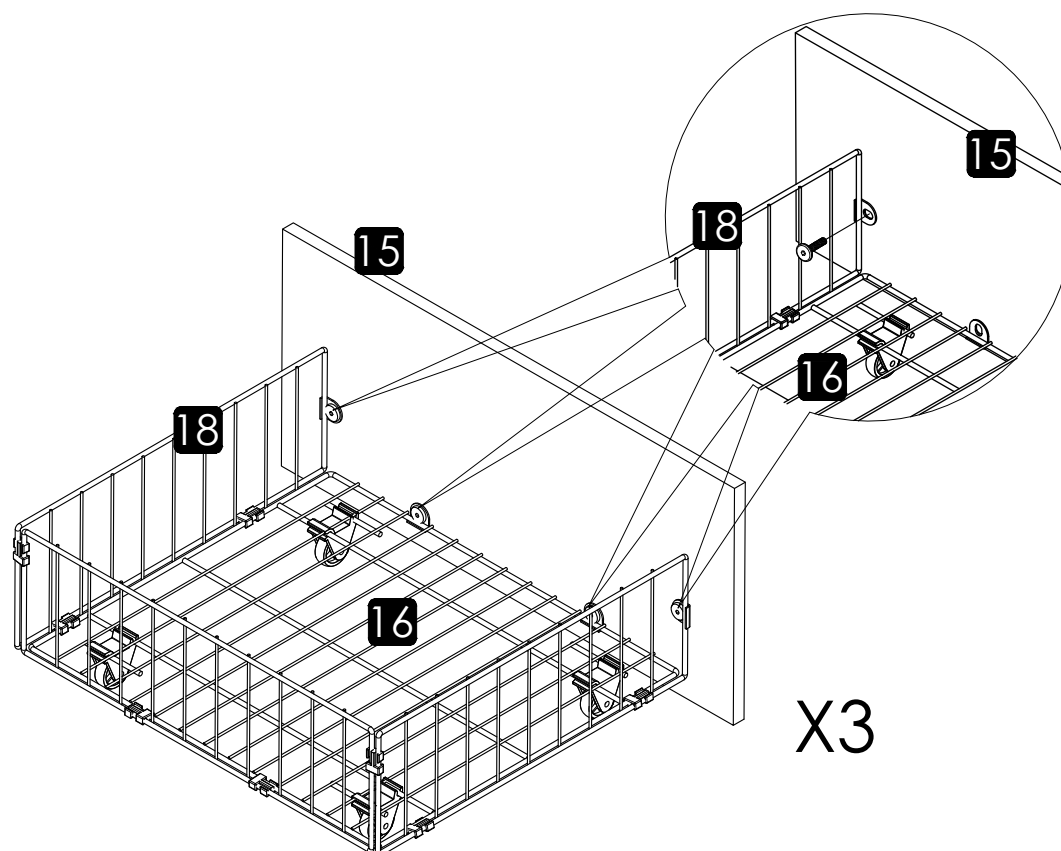
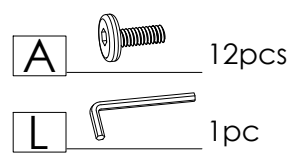

## Schritt 16

