

A

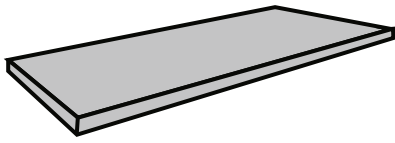

x1

B

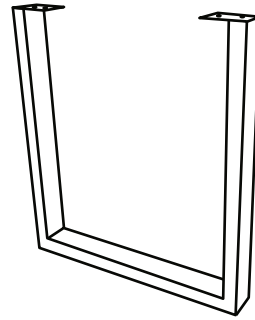

x2



C

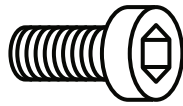

20MM NUT

x8

D

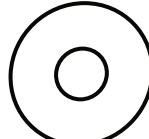

20MM WASHER

x8

E

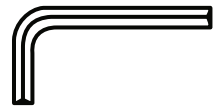

x1

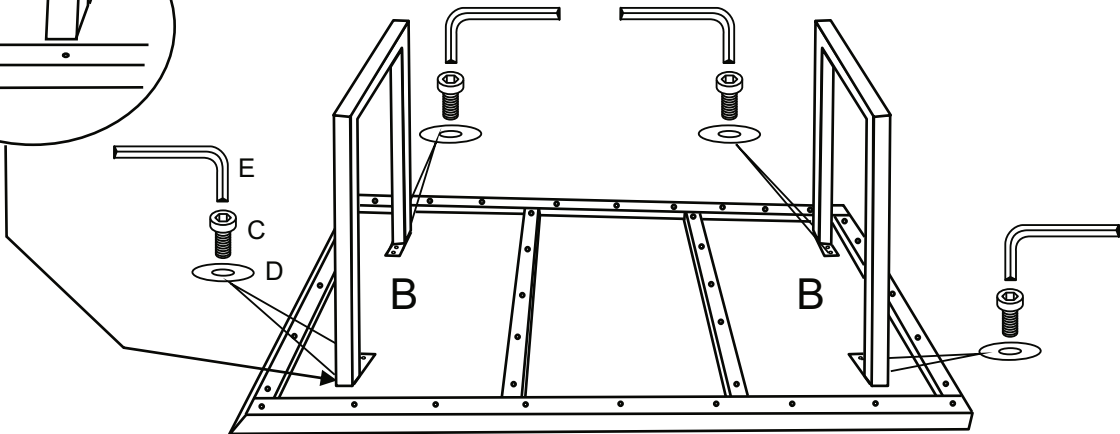
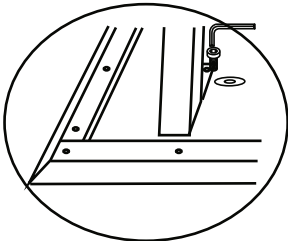

A

