

PICASSO  
8100/2500/8142  
8141/2500/8300

- |           |  |           |   |
|-----------|--|-----------|---|
| <b>D</b>  | MONTAGEANLEITUNG<br>BEDIENUNGSANLEITUNG                | <b>GB</b> | ASSEMBLY INSTRUCTIONS<br>INSTRUCTION MANUAL         |
| <b>NL</b> | HANDLEIDING VOOR DE MONTAGE<br>GEBRUIKSAANWIJZING      | <b>PL</b> | INSTRUKCJA MONTAŻU<br>INSTRUKCJA OBSŁUGI            |
| <b>TR</b> | MONTAJ TALIMATI<br>KULLANIM KLAVUZU                    | <b>RU</b> | ИНСТРУКЦИЯ ПО МОНТАЖУ<br>ИНСТРУКЦИЯ ПО ЭКСПЛУАТАЦИИ |
| <b>RO</b> | INSTRUCȚIUNI DE INSTALARE<br>INSTRUCȚIUNI DE UTILIZARE | <b>IT</b> | ISTRUZIONI DI MONTAGGIO<br>MANUALE DI ISTRUZIONI    |
| <b>FR</b> | NOTICE DE MONTAGE<br>MANUEL INSTRUCTIONS               | <b>SK</b> | MONTÁŽNY NÁVOD<br>NÁVOD NA POUŽITIE                 |
| <b>HU</b> | KÖZGYŰLÉS UTASÍTÁSOK<br>KEZELÉSI UTASÍTÁS              | <b>CZ</b> | MONTÁŽNÍ NÁVOD<br>NÁVOD K POUŽITÍ                   |
| <b>SI</b> | NAVODILA ZA MONTAŽO<br>NAVODILA ZA UPORABO             | <b>PT</b> | INSTRUÇÕES DE MONTAGEM<br>MANUAL DO USUÁRIO         |
| <b>ES</b> | INSTRUCCIONES DE MONTAJE<br>MANUAL DEL USUARIO         | <b>HR</b> | UPUTE ZA MONTAŽU<br>UPUTE ZA UPOTREBU               |

**F/B**

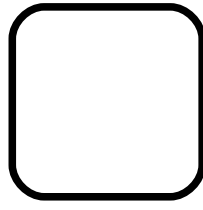
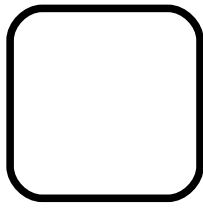

0019

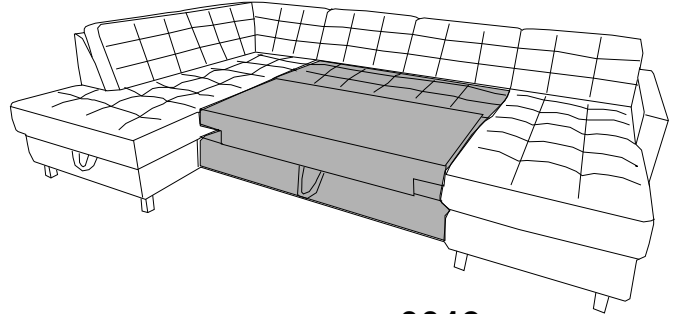
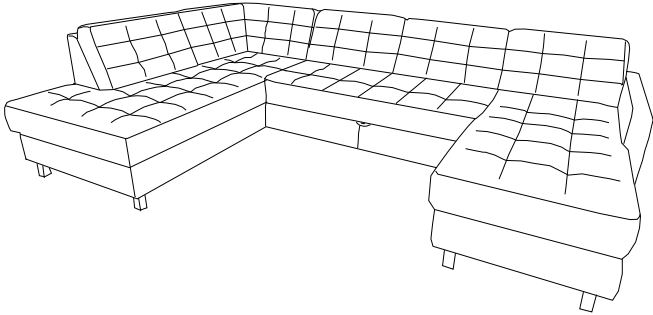

0019

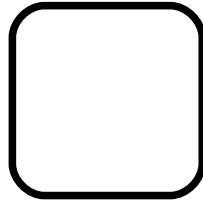
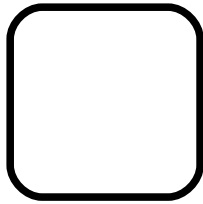

0089

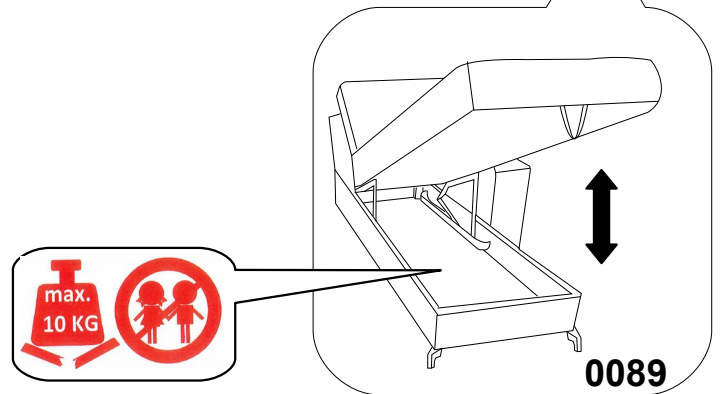
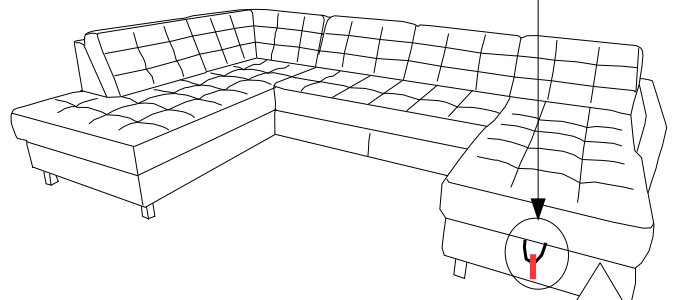
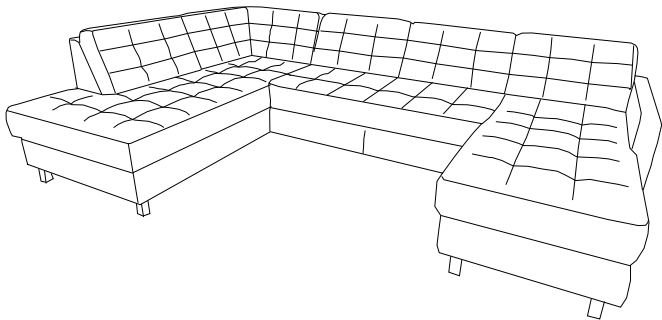
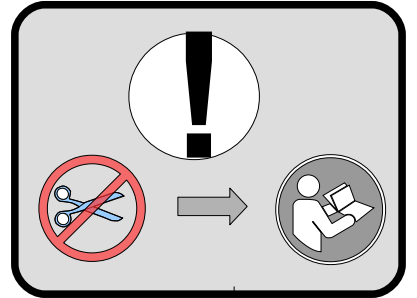





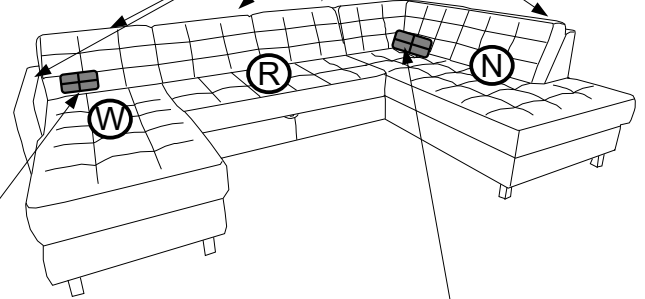
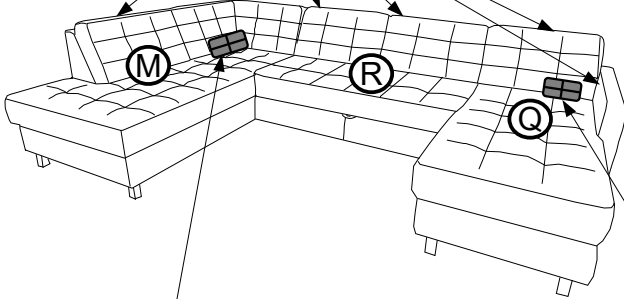

0089



L

R



<b>f</b> H- 100 	<b>g</b> H- 100 	<b>v</b> H- 3 
X4	X3	X4

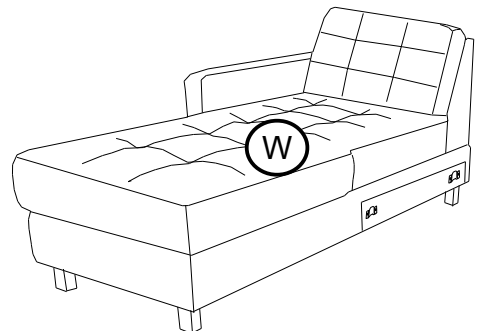
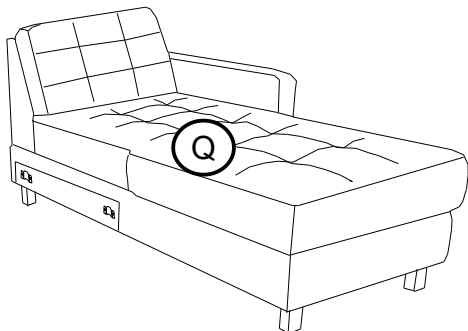
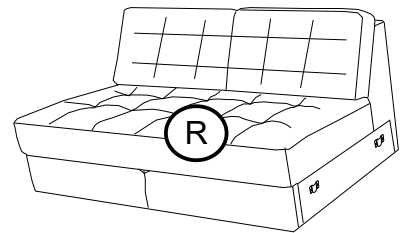
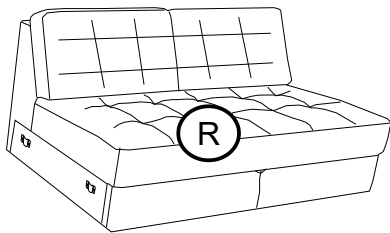
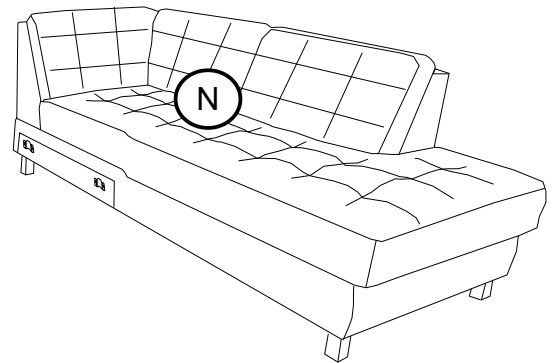
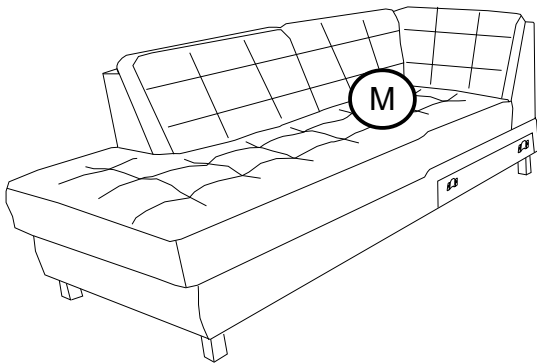

<b>f</b> H- 100 	<b>g</b> H- 100 	<b>v</b> H- 3 	[mm]
X5	X2	X5	

<b>f</b> H- 100 	<b>g</b> H- 100 	<b>v</b> H- 3 
X4	X3	X4

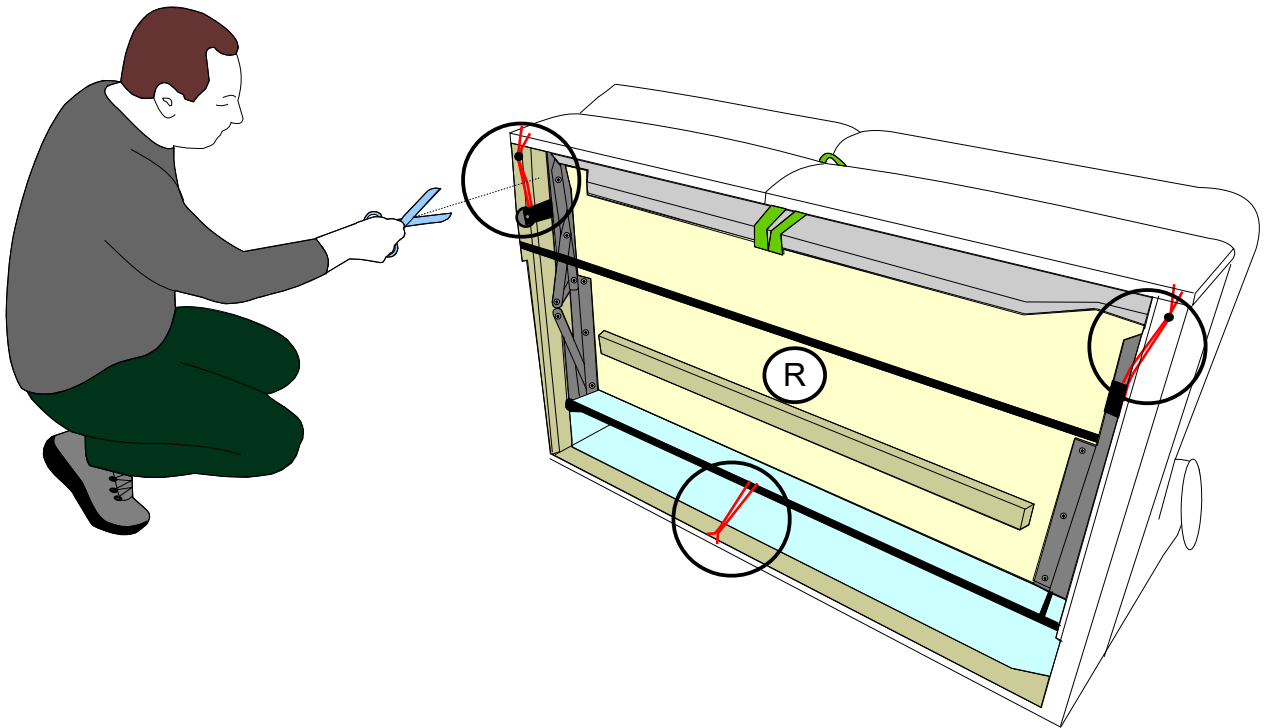
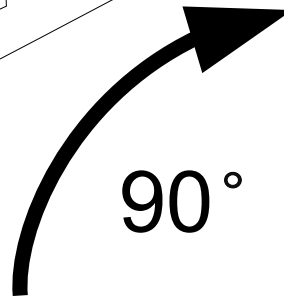
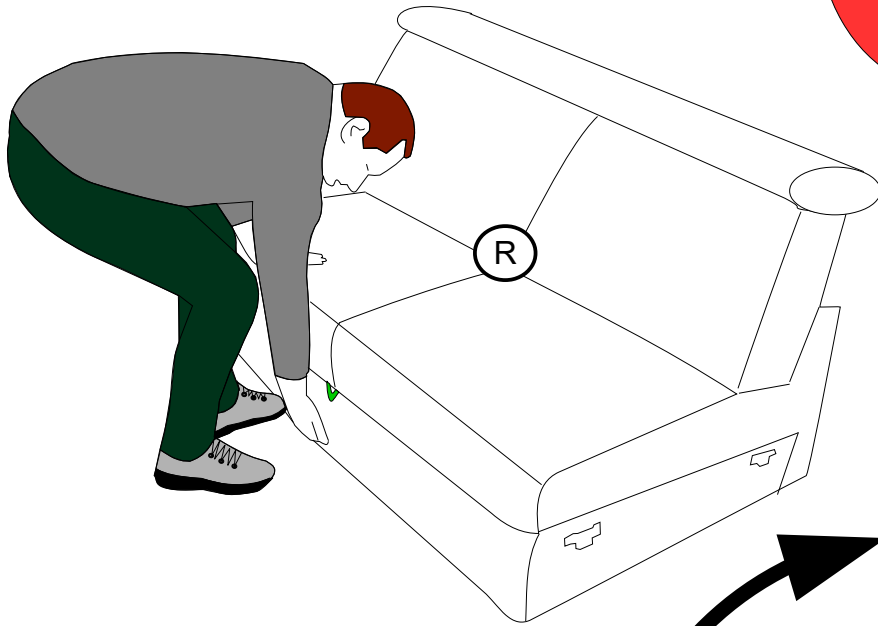



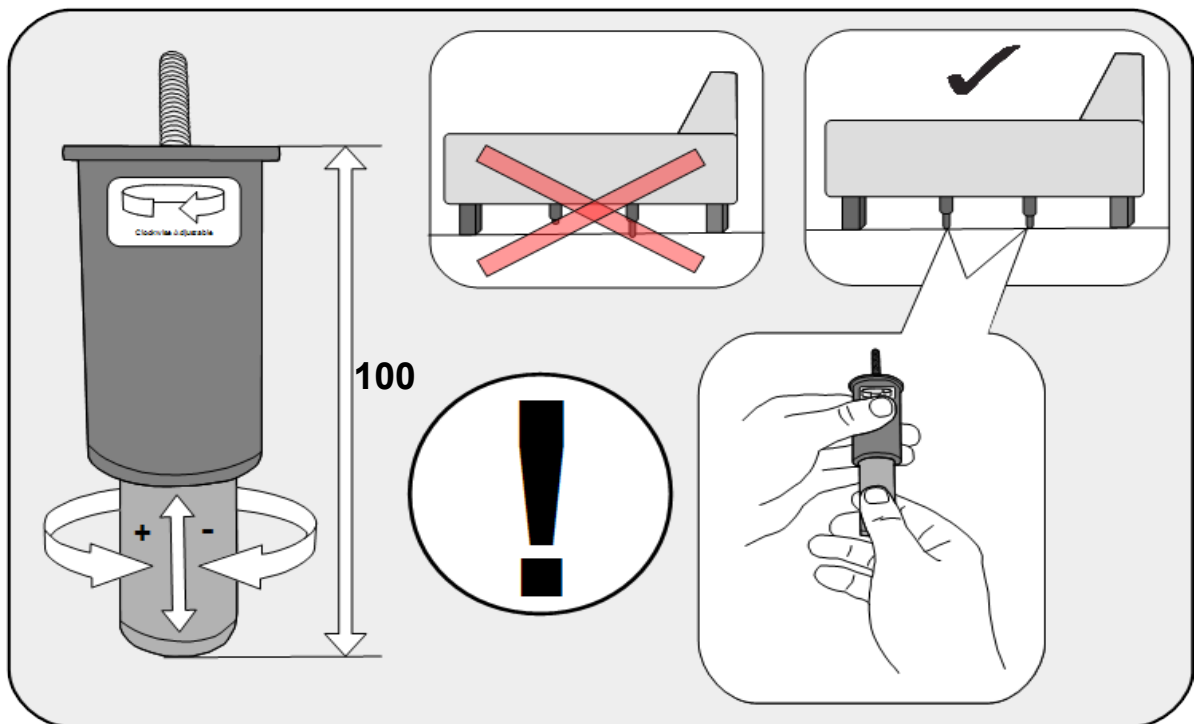
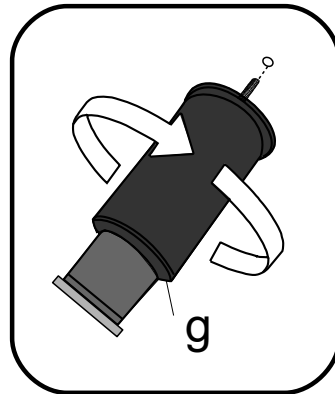
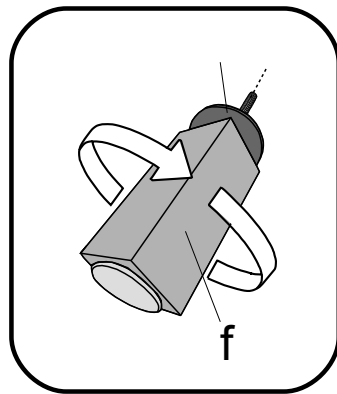
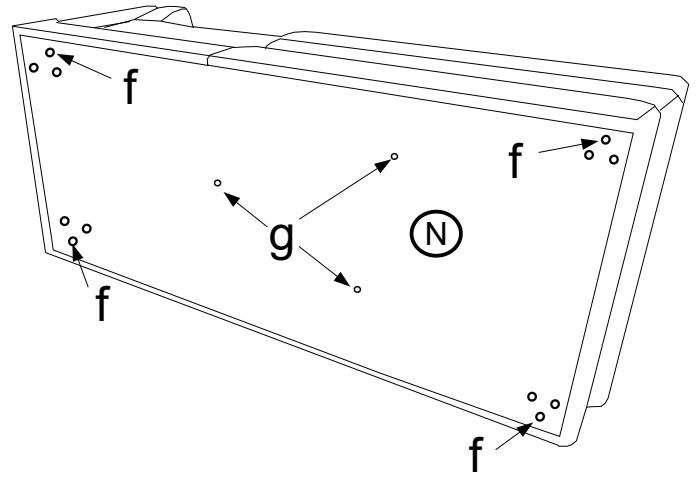
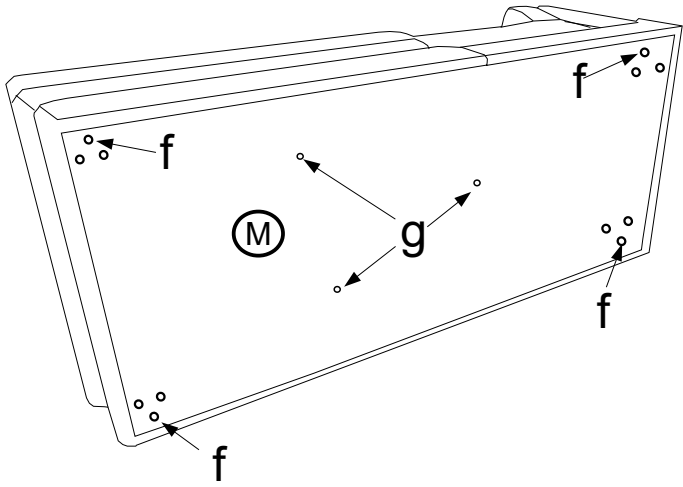

0019

<b>f</b> H-100 	<b>g</b> H-100 	<b>v</b> H-3 
X4	X3	X4



<b>f</b> H-100  X5	<b>g</b> H-100  X2	<b>v</b> H-3  X5
--	--	--

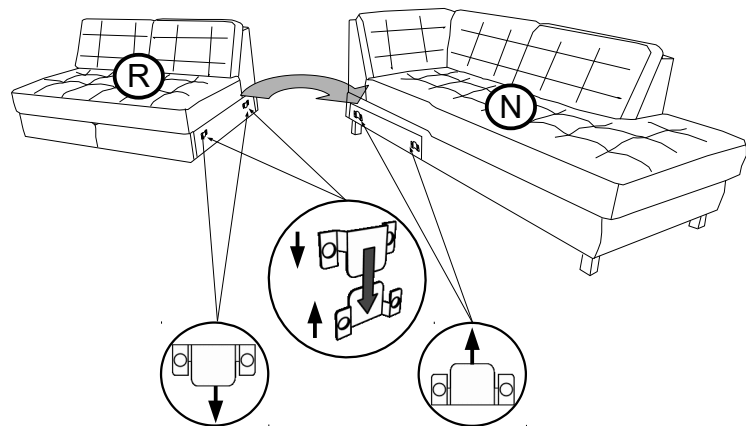
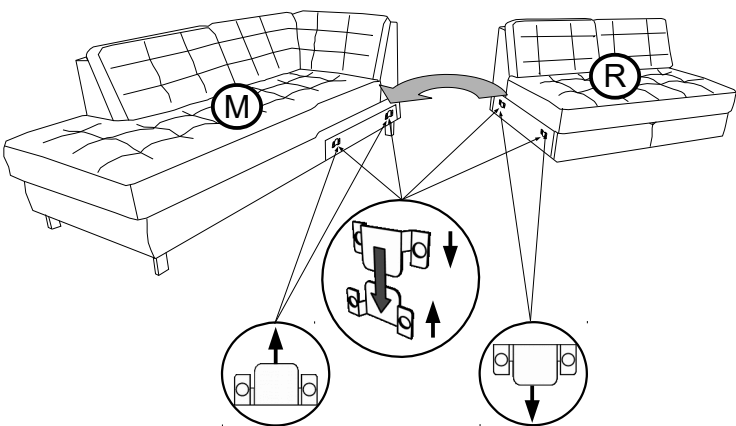
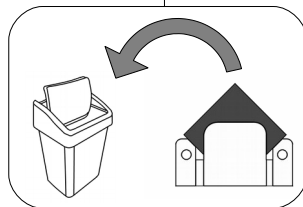
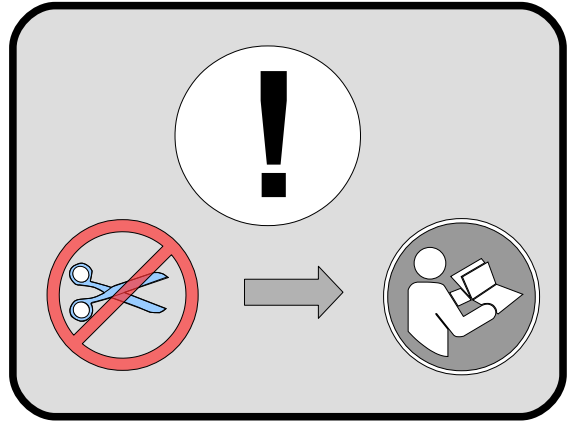
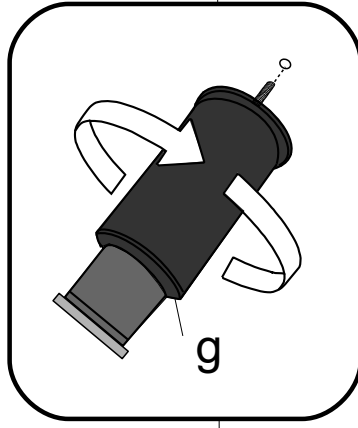
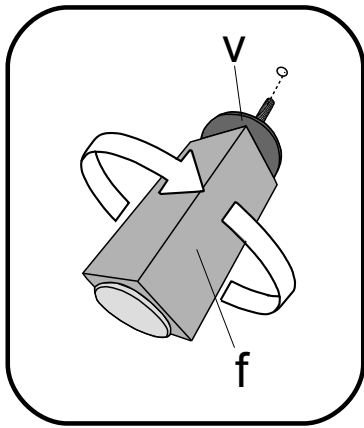
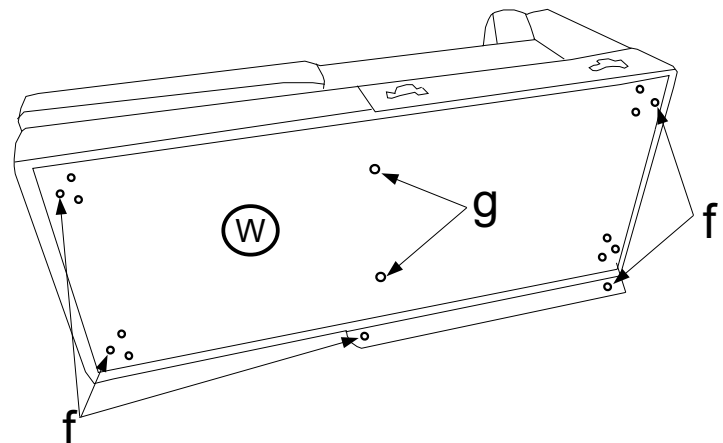
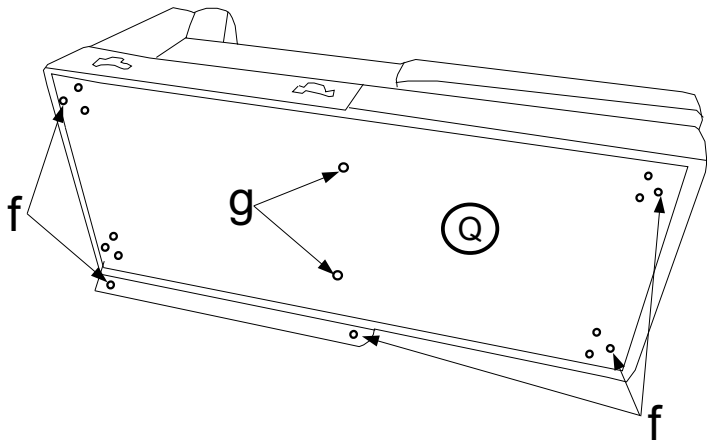

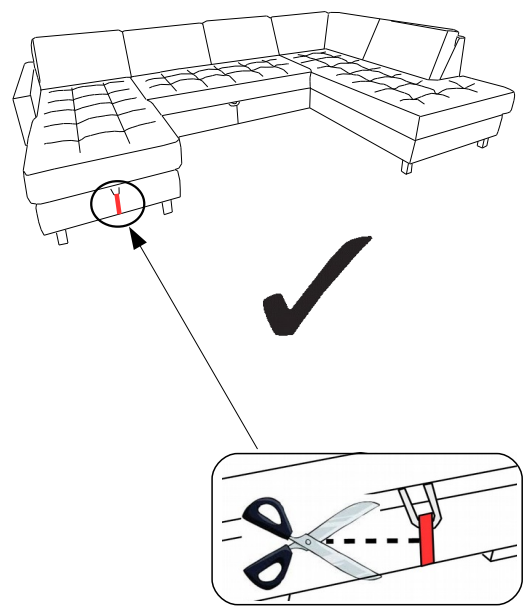
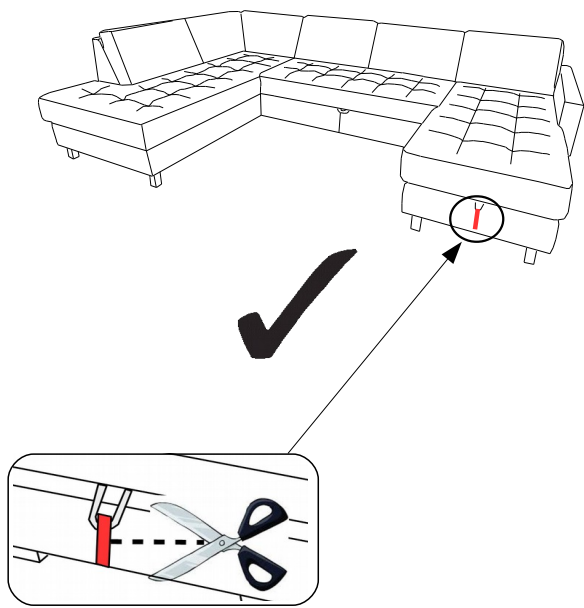
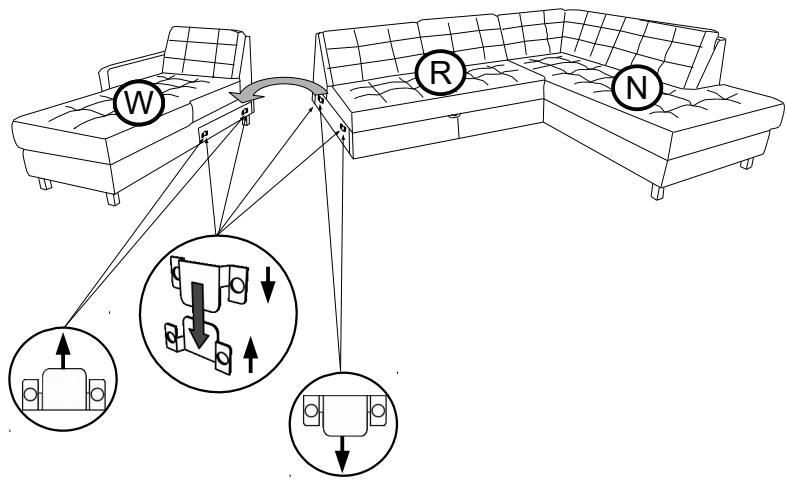
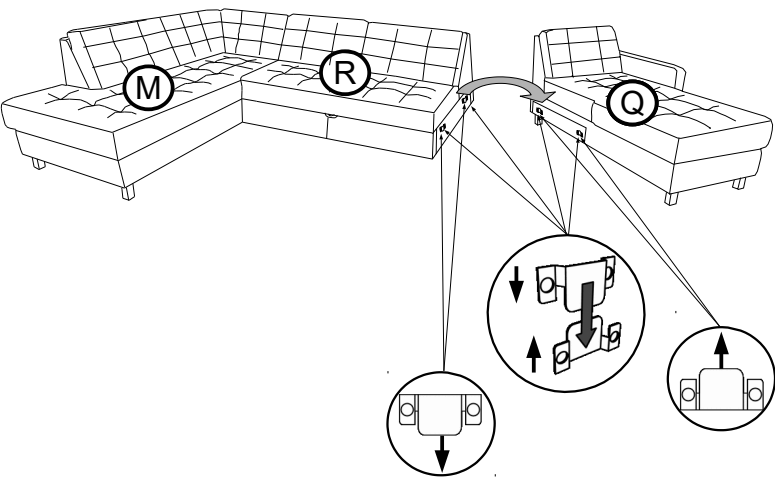

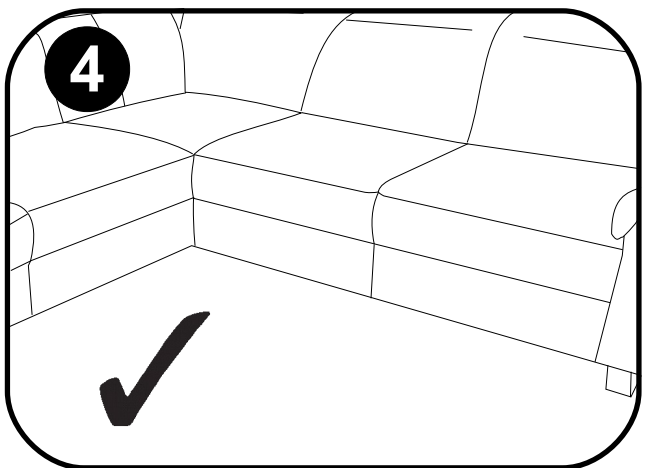
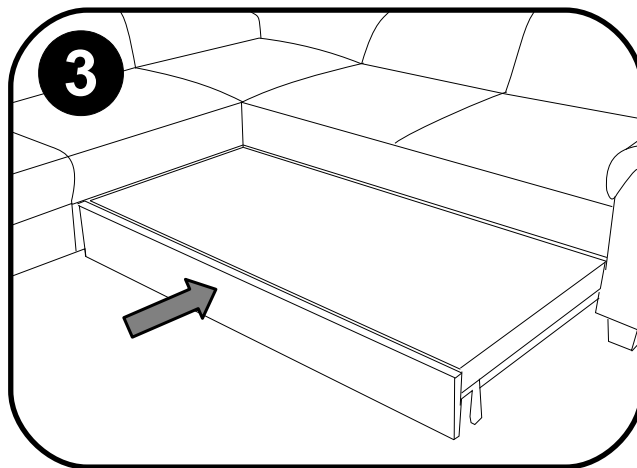
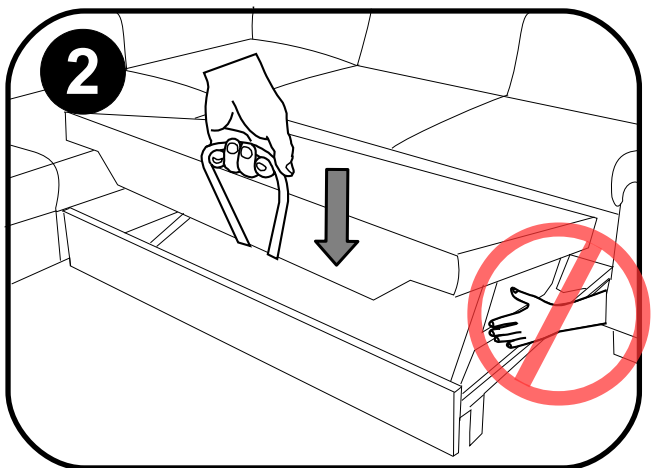
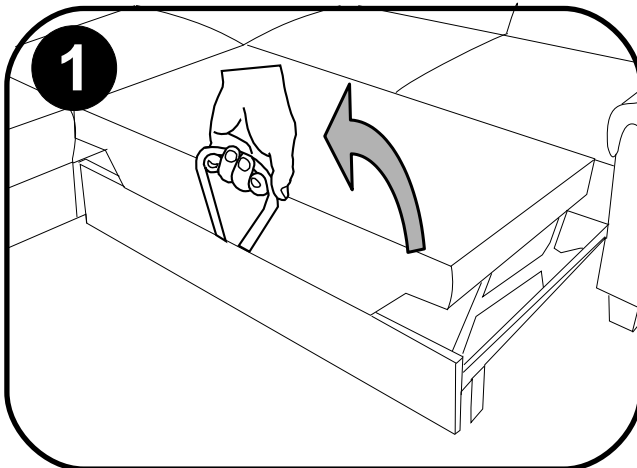
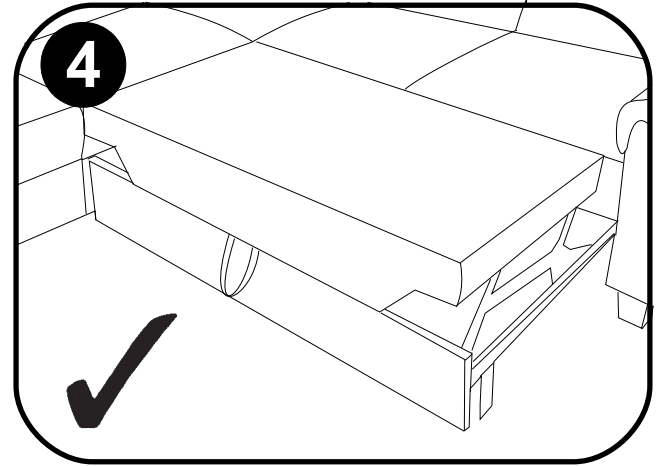
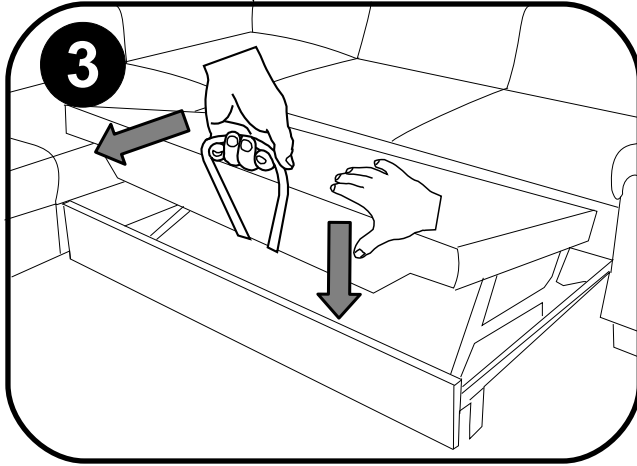
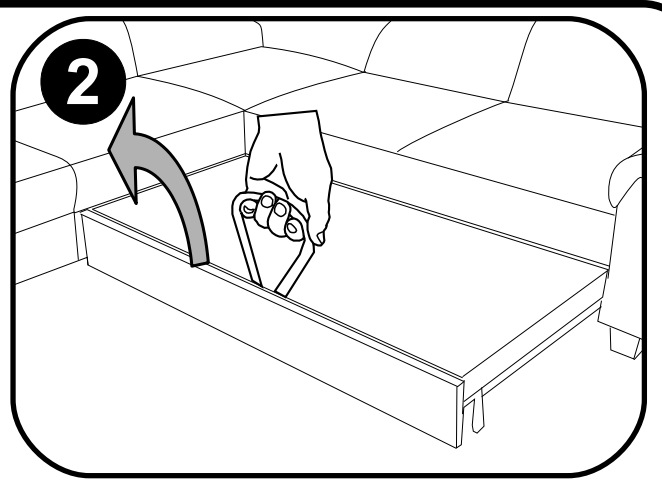
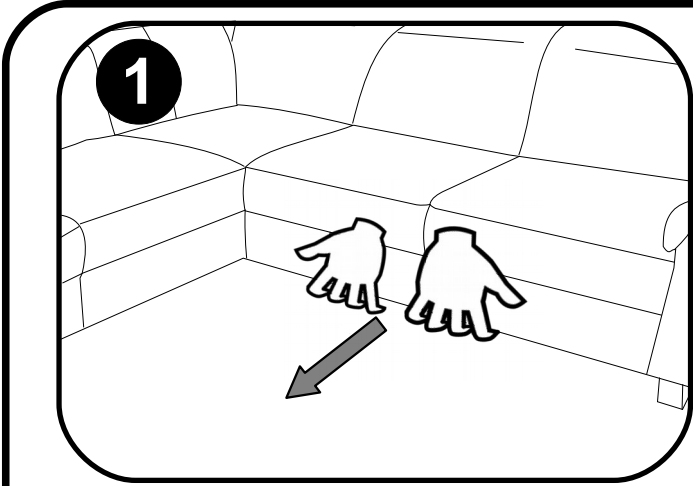
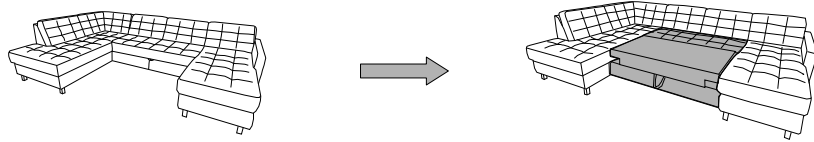





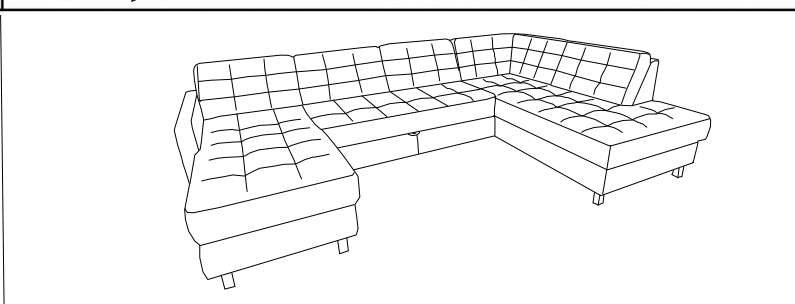
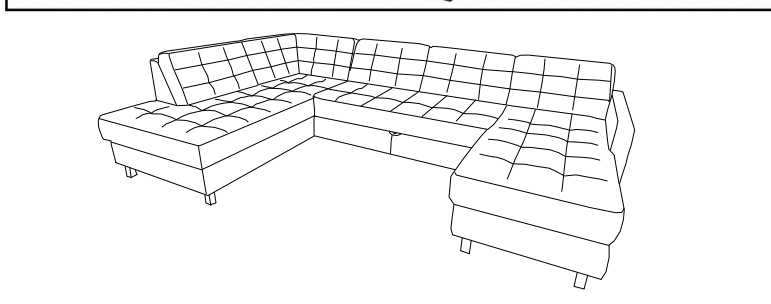
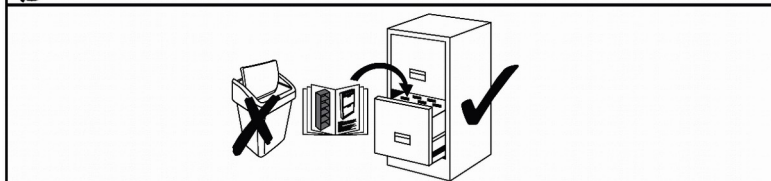
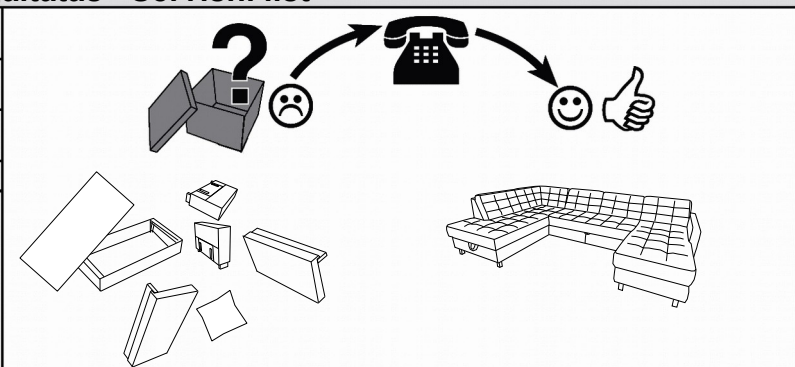

Service · Dienstverlening · Servis · Servis · Сервисная служба · Serviciu · Services · Servizio  
 ·Servisný list · Szolgáltatás · Servisní list

Name · Naam · Nazwa · İsim · Название · Nume · Nome · Názov · Názov ·  
 Název · Neve  
**PICASSO**  
 Typ · Type · Tip · Тип · Tipo · Típus



<b>f</b> H- 100 	<b>g</b> H- 100 	<b>v</b> H- 3 [mm] 
--	--	---

