

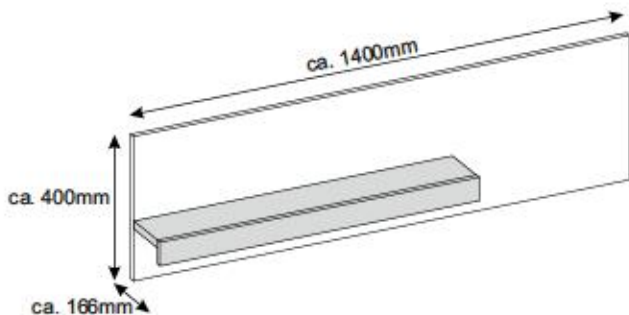

- ⓓ **Montageanleitung**
- ⓃⓁ **Handleiding voor de montage**
- ⓉⓇ **Montaj talimatı**
- ⓕ **Notica de montage**
- ⒸⓏ **Montážní návod**
- ⓗⓤ **Szerelési útmutató**
- ⓖⓔ **Assembly Instructions**
- Ⓟ **Instrukcja montażu**
- Ⓡⓤ **Инструкция по монтажу**
- Ⓡⓐ **Istruzioni di montaggio**
- ⓈⓀ **Návod na montáž**
- Ⓡⓞ **Instrucțiunile de montaj**
- ⓔⓢ **Instrucciones de montaje**
- ⓉⓇ **Montaj Talimatı**

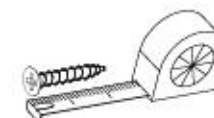

n°	L[mm]	B[mm]	T[mm]	Versione	Coli
1	1400	400	16	1	1/1
2	900	134	16	1	1/1
3	902	65	16	1	1/1

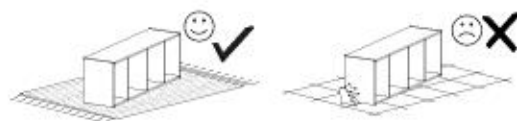
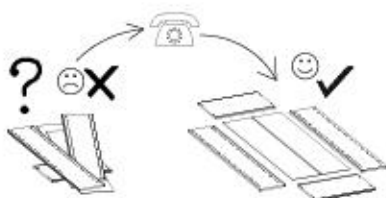
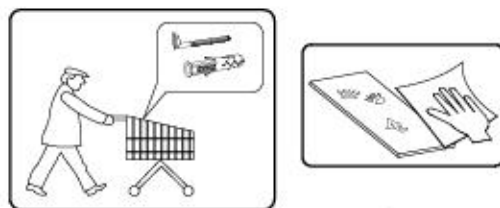
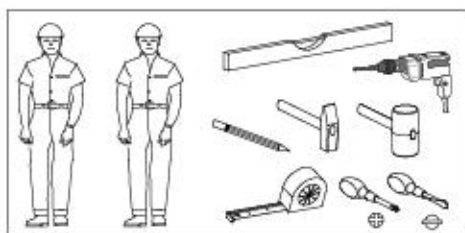
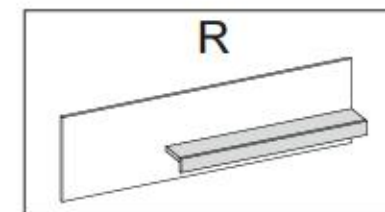
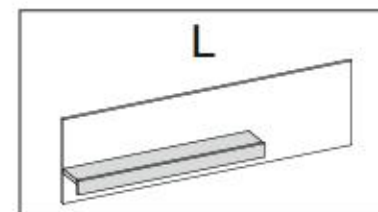
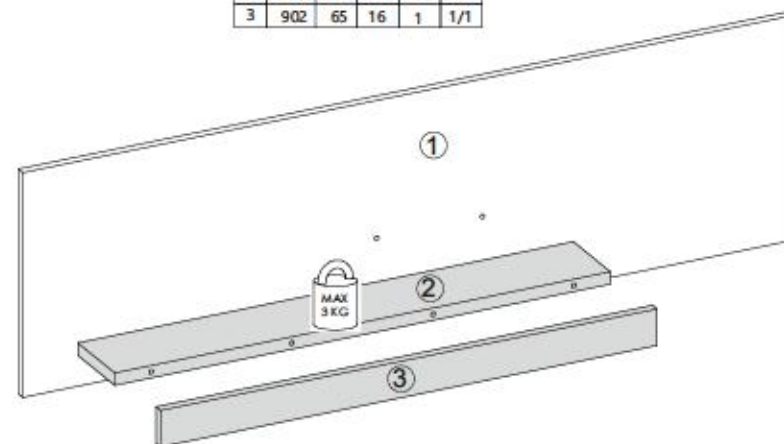

A1 ø7x50 x4	W2 x1	G52 5x11 x6	P10 x3	I7 x4
K1 x4	K10 x4			

3/8

CITY / GIRON 73



I

G52

5x11



x6

P10



x3

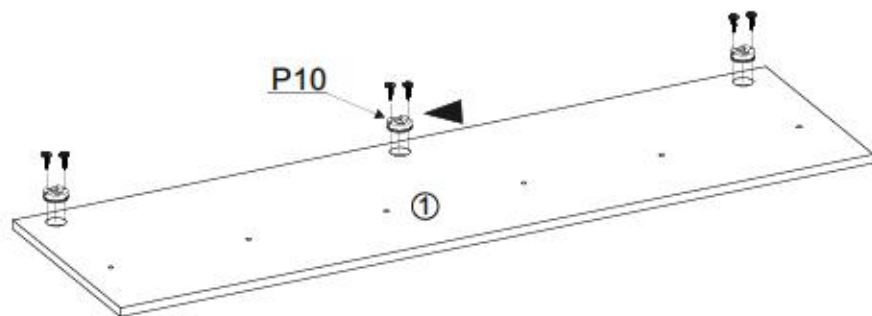

P10

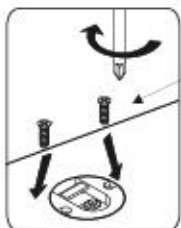
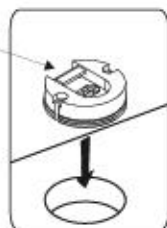

G52



II

K1



x4

K10



x4

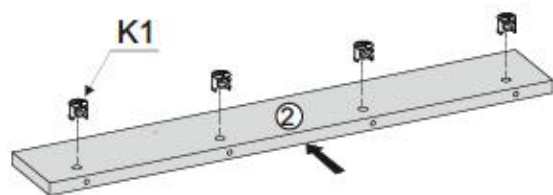

K10

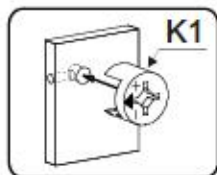
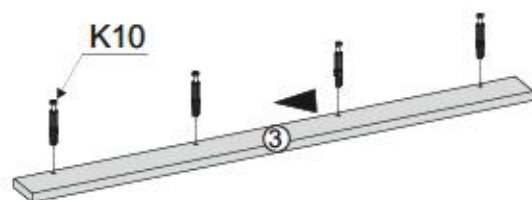

4/8

CITY / GIRON 73



III

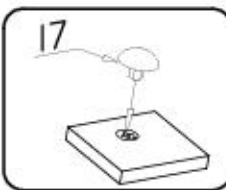
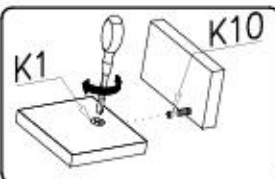

I7



x4

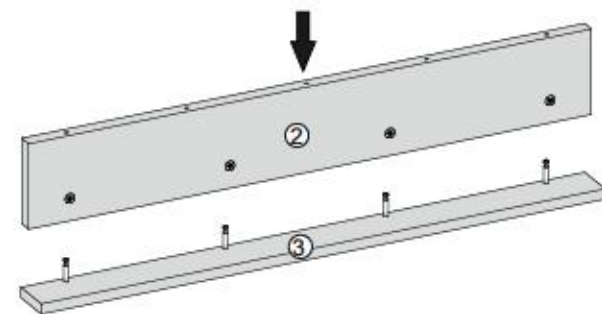

IV

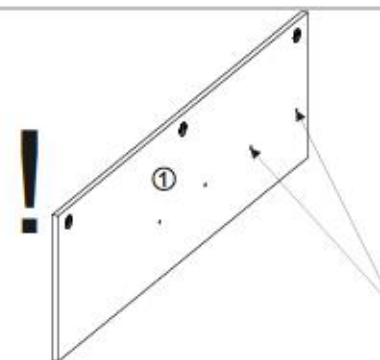
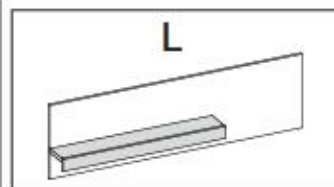

A1

ø7x50

x4

W2

x1

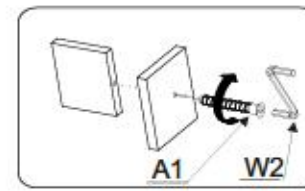
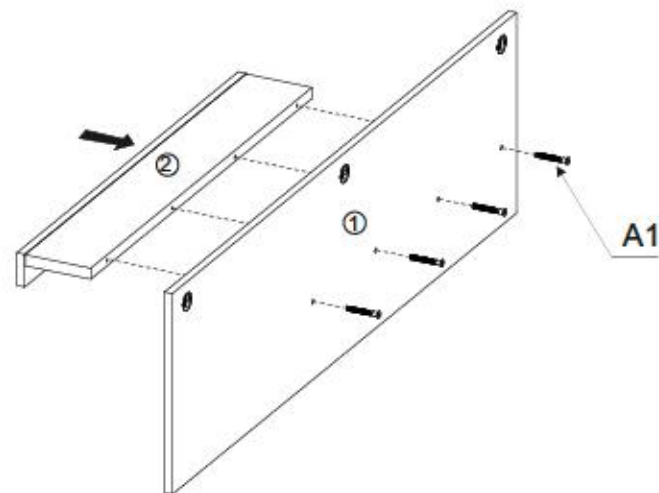
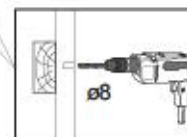

5/8

CITY / GIRON 73



V

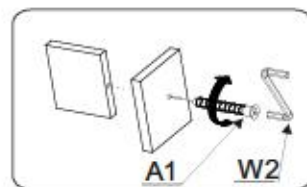
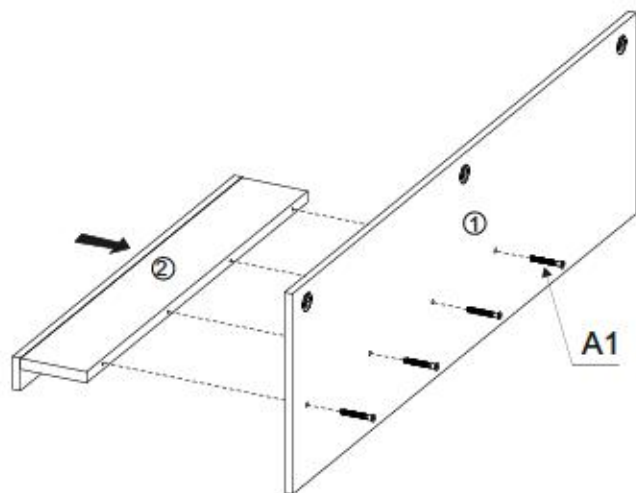
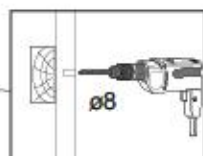
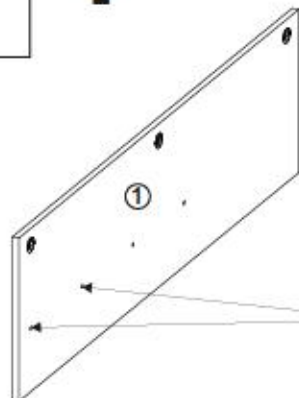
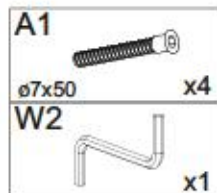
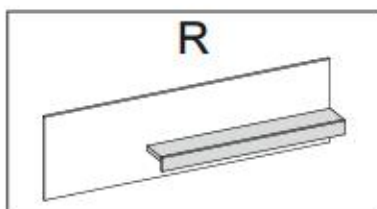

6/8

CITY / GIRON 73



VI

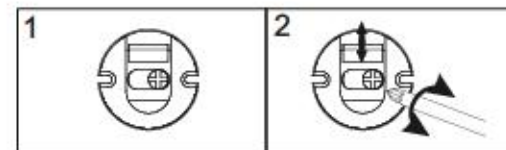
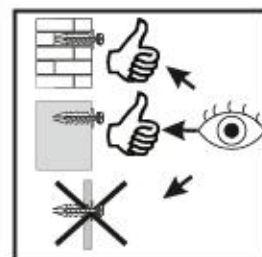
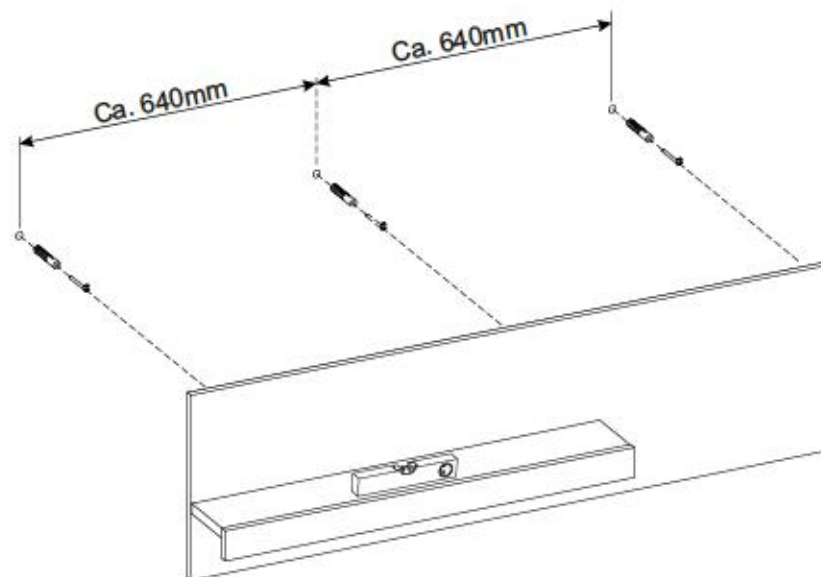
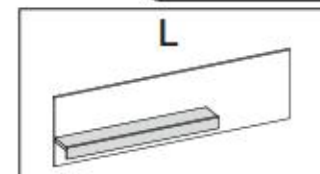
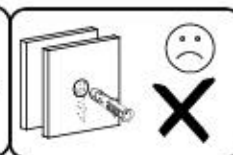
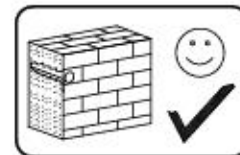

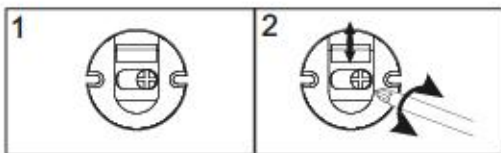
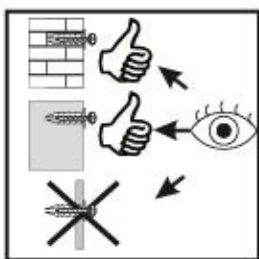
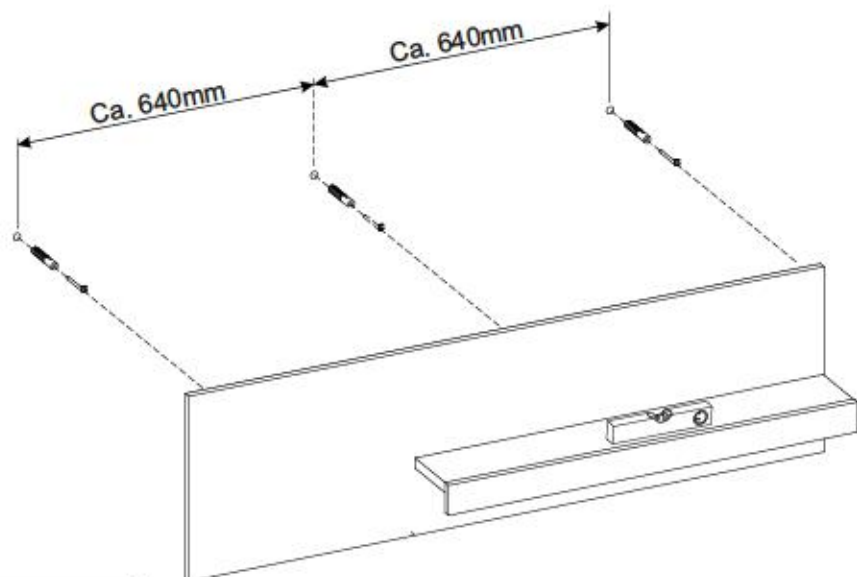
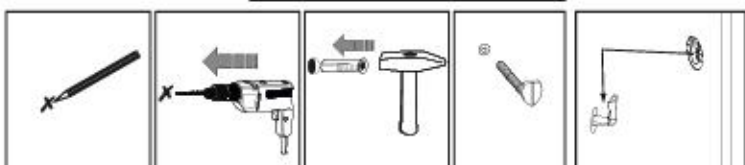
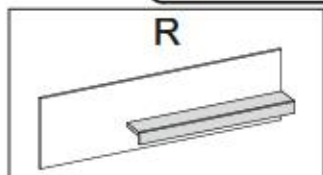
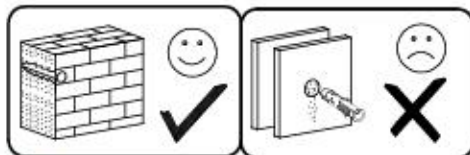

## VII

Name • Nom • Nome • Naam • Nazwa • Jméno  
• Názov • Név • Denumire • Isim • Имя

Nr • No • N° • Номер • Č • Sz

Typ • Type • Tip • Típus • Тipo • Tun

CITY / GIRON

--

73

**D** Utolsó Díszítés/Építési lépés  
Sóha írni ne Beszélgetés helyén, kivonon! Ha ezzel Szerviszhoz  
direkt az adatai tartalmazó címen, akkor megkérjük, hogy a  
Beszélgetés helyén a megadott címre forduljon. Ha a  
Beszélgetés helyén a megadott címre forduljon, akkor megkérjük,  
hogy a megadott címre forduljon.

**GB** Our direct order service for filling  
If a filling part is missing, you can e-mail this service card directly  
to the address below. However, we can only send filling parts in  
this way. If you have any other issues for completion concerning  
your item of furniture, please contact your furniture store directly.

**CZ** Naše přímá služba pro kování  
Chybí-li vám nějaký díl z kování, můžete tuto službu rovnou odešlat  
e-mailem přímo na níže uvedenou adresu. Touto cestou však  
můžeme odeslat jen díly kování. Pokud byste měli nějaký jiný problém  
s výrobkem, obraťte se přímo na svého prodejce nábytku.

**F** Bien étaler la notice de montage  
Si vous remarque une erreur, veuillez envoyer directement la présente  
carte service l'adresse e-mail indiquée ci-dessous. Cependant, ceci  
nous permet uniquement d'envoyer des s. Pour tout autre type  
de problème concernant votre meuble, veuillez contacter  
directement votre magasin d'ameublement.

**I** Il nostro servizio diretto per i ordini della lavorazione  
Qualora Vi dovesse mancare un pezzo di fissaggio, allora Vi  
preghiamo di inviare questa carta di servizio immediatamente  
all'indirizzo sottostante. Possiamo inviare i pezzi di fissaggio  
solamente per mezzo di questo procedimento. Qualora dovesse  
avere qualche altro problema in merito al mobile, allora Vi  
preghiamo di rivolgerVi direttamente al Vostro Negozio di mobili.

**BG** Нашата директна услуга за облич  
Ако липовата част от комплектта, потърсете настоящата  
сервисна карта и я изпратете на e-mail адреса, посочен  
по-долу. Тази услуга може да достави само комплектни  
детайли от облича. Ако установите други дефекти по  
мебелта, се свържете директно с облича на мебелите си.

**NL** Onze directie voor losse onderdelen  
Wanneer er een onderdeel ontbreekt, kunt u deze aanvragen  
direct aan onze afdeling e-mailadres sturen. Wij kunnen langzame  
weg echter alleen bestelbare vastzetten. Mocht u een ander  
probleem met een meubel hebben, verzocht wij u contact op te  
nemen met uw meubelwinkler.

**PL** Nasz bezpośredni serwis części montażowych  
Jeżeli brakuje części konstrukcyjnych do montażu, prosimy o przesłanie  
tej karty bezpośrednio na adres e-mailowy podany poniżej.  
W ten sposób możemy przesłać jedynie brakujące części.  
W przypadku innych problemów dotyczących mebla, prosimy o kontakt  
z naszym meblowcem, w którym został dokonany zakup.

**HR** Servis za dijelove  
U slučaju da nedostaje neki od dijelova molimo vas da na dolje  
navedenu mail adresu pošaljete ovaj servisni kartić. Na ovaj način  
možu se dostaviti samo dijelovi. U slučaju da imate dodatne prigovore  
vezane uz loš rad namještaja molimo vas da se obratite bravno  
trgovini namještaja gdje je isti kupljen.

**HU** Direktbeszélgetés szabadkísérlettel  
Ha hiányzik egy darab, ezt a kártyát közvetlenül elküldhet az  
alább található címre. Azonban csak azokat a darabokat lehet így  
küldeni. Amennyiben másféle problémát szeretne felvetni, kérem,  
forduljon közvetlenül a bolti értékesítőhöz.

**SK** Naše přímá služba pro částí kování  
Ak by Vám chýbala niekajá časť kování, môžete poslať  
túto službu rovnou e-mailom na nižšie uvedenú  
adresu. Týmto spôsobom však môžeme poslať iba  
diely kování. Ak by ste mali iný problém s výrobkom,  
obráťte sa priamo na Vašu predajňu nábytku.

**SLO** Naše direktna služba za delce za obličje  
Če vam manjka kakikoli delce za obličje, lahko to storite  
neposredno po e-pošti direktno na spodnji naslov. Po to  
način lahko pošljemo samo delce. Če imate kakikoli drug delce  
povzročajo, se obrnite neposredno na vašo trgovino pohištva.

**RO** Serviciu noastră directă pentru accesorii  
În cazul în care vă lipsește o piesă de înlocuire, puteți  
direct acest card de serviu prin e-mail la adresa de mai jos. Noi  
nu putem expedia piesa de înlocuire decât pe această cale.  
De altfel, o altă reclamație referitoare la piesa de mobilă se  
trădește să rugăm să vă adresați direct la magazinul dvs. de mobilă.

**RUS** Наша прямая служба для поставки фурнитуры  
Если окажется, что Вам не хватает той или иной комплектной  
фурнитуры, Вы можете отправить данную карту по факсу  
непосредственно на нижеприведенный адрес электронной  
почты. Однако, таким образом мы можем переслать лишь  
фурнитуру. Если же у Вас возникнут иные претензии относительно  
карты, пожалуйста, обращайтесь непосредственно в магазин,  
осуществивший продажу.

**S** Vår direkte tjena för beställningar  
Om du saknar en beställning, kan du skicka detta servicekort direkt  
till e-postadressen som anges nedan. Tillåt oss dock bara skicka  
delar till detta sätt. Om du har några andra frågor om ditt  
möbels eller annan anledning, rikta du kontakten till möbelsbutiken direkt.

**ES** Nuestro servicio directo para accesorios  
Si le falta algún accesorio, puede enviar esta tarjeta de servicio directamente  
a la siguiente dirección. No obstante, por este método solo podemos  
enviar accesorios. Si tiene alguna otra objeción sobre su mueble, consulte  
directamente con su mueblería.

**TR** Doğrudan İhtiyaçlarınız İçin  
Bir aksesuar eksikse, bu karti doğrudan aşağıdaki butana adresine  
doğrudan mail ile gönderebilirsiniz. Sadece bu yolla aksesuarlar  
gönderebiliriz. Mobilyanızda başka bir şikayeti varsa lütfen doğrudan mobilya satışçınıza  
başvurun.

nr	L [mm]	B [mm]	T [mm]	Wenge	Colt
1	1400	400	16	1	1/1
2	900	134	16	1	1/1
3	902	65	16	1	1/1

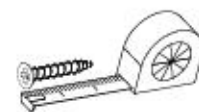
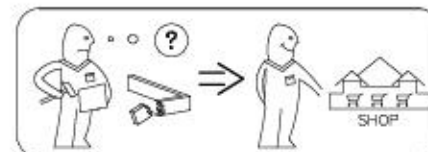
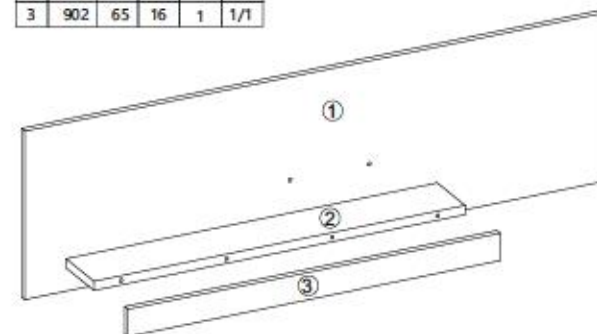

<b>A1</b> Ø7x50 X...	<b>W2</b> X...	<b>G52</b> 5x11 X...
<b>P10</b> X...	<b>I7</b> X...	<b>K1</b> X...
<b>K10</b> X...		

