

# Service

Name **BARCELONA**

Typ **T 12 - KOMBI VITRINE**

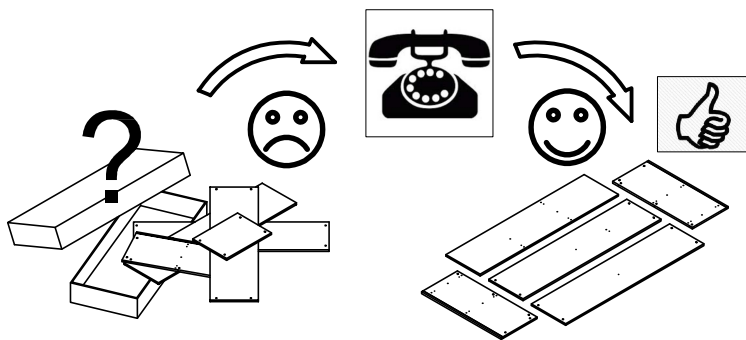
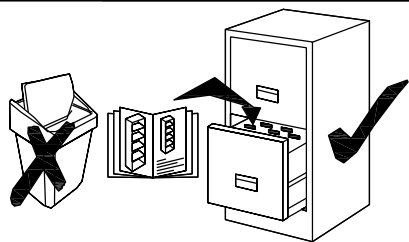

- ① 752×372×38
- ② 666×330×25
- ③ 712×352×29
- ④ 752×372×28
- ⑤ 1934×352×19
- ⑥ 1934×352×19
- ⑦ 1905×332×18
- ⑧ 422×320×18
- ⑨ 272×295×18
- ⑩ 420×290×18
- ⑪ 270×290×18
- ⑫ 413×300×6
- ⑬ 1929×296×20
- ⑭ 445×500×20
- ⑮ 989×418×4
- ⑯ 445×500×20
- ⑰ 1921×728×3
- ⑱ 420×997×4

- ⑲ 60×60×15
- ⑳ 989×160×4

⑳ 690×342×342  
**Beleuchtung!!**

㉒ **Trafo!!**

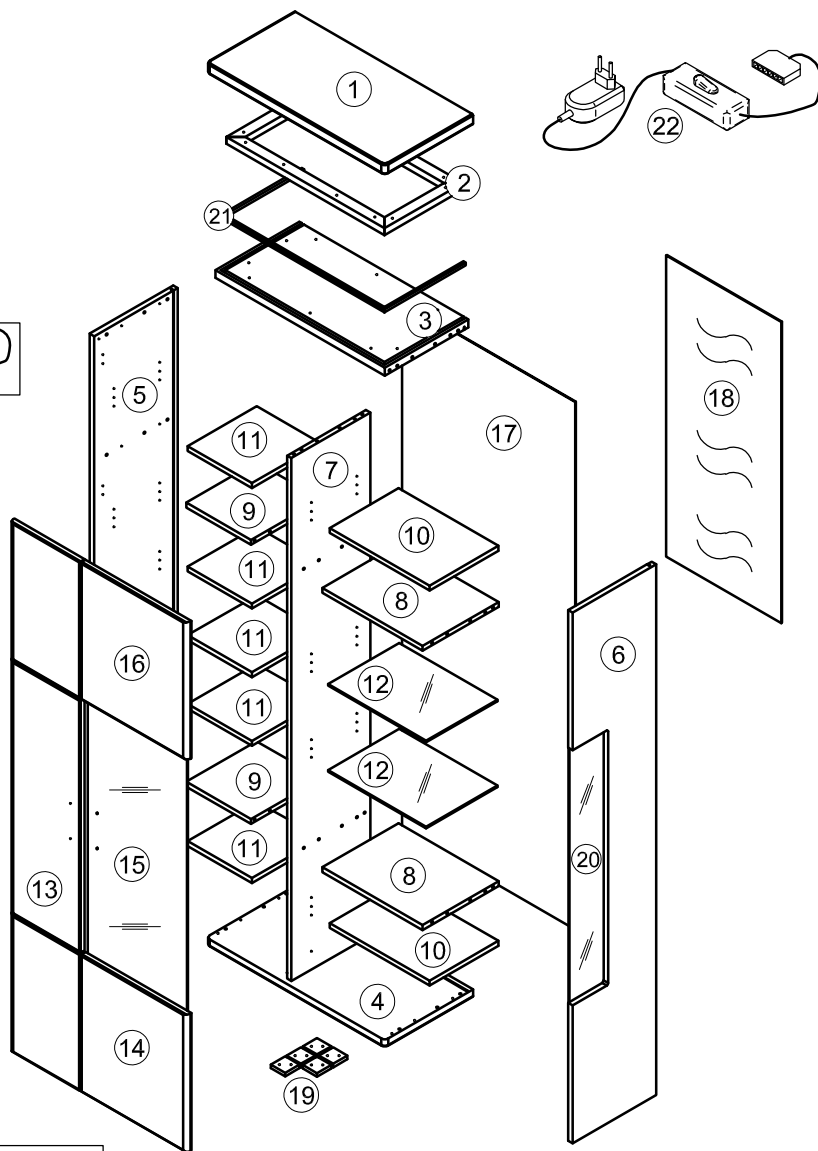

OPTION		
005052ZB_BEL.	005052ZB_TRAFO	005091ZB
x1	x1	x1

<b>D1</b> Ø8x32 mm 	<b>GL</b> 	<b>S2-40</b> 4x40mm 	<b>A2</b> 60x20x15 mm 	<b>PC</b> Ø7/9×4mm 	<b>M25</b> M4x25 mm 
<b>D3</b> Ø8x52 mm 	<b>S1-16</b> 3x16 mm 	<b>S2-35</b> 4x35mm 	<b>GH</b> LAMA 	<b>P1</b> 	<b>M10</b> M4x10 mm 
<b>EX</b> Ø15x12 mm 	<b>W1</b> 	<b>S2-16L</b> 4x16 mm 	<b>W4</b> 	<b>C2</b> 	<b>ES</b> 6,3x13mm 
<b>T1</b> 	<b>B</b> 	<b>S-16</b> 3,5x16 mm 	<b>H1</b> 0mm 	<b>M1</b> 	
<b>T2</b> 	<b>ST</b> 	<b>PG</b> 128 mm 			

Modellname: **BARCELONA**

**MONTAGEANLEITUNG**  
TYPE T12 - KOMBI VITRINE

**1/2**

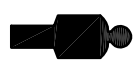

1 Person

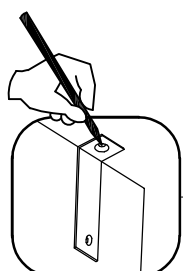
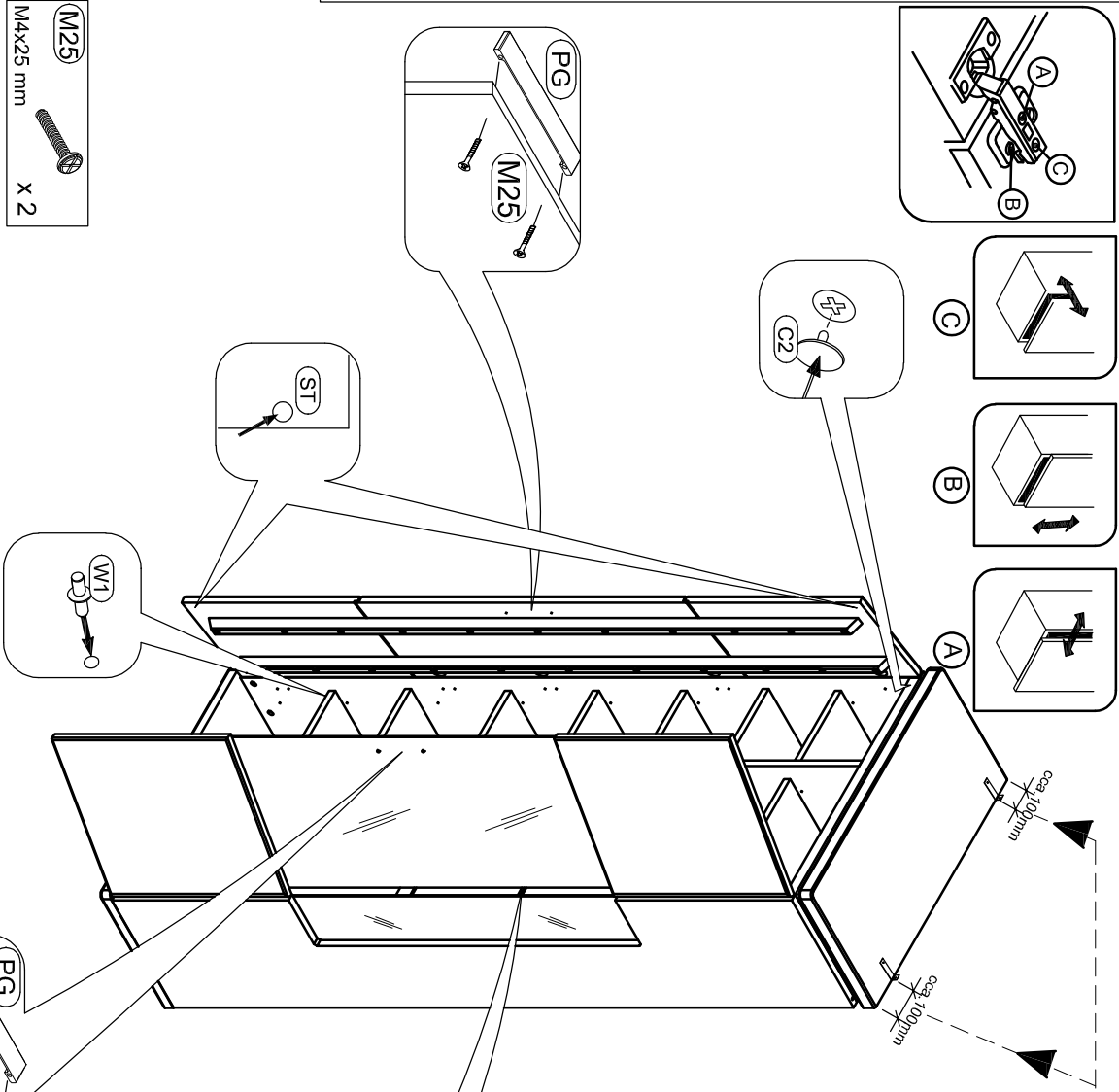
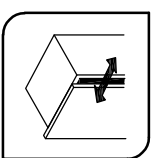
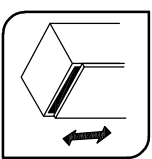
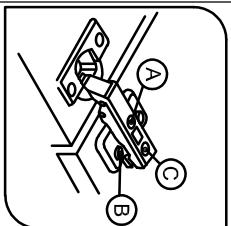
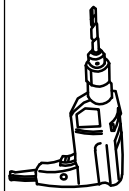
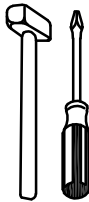
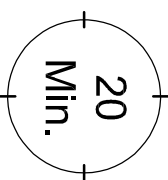

1.

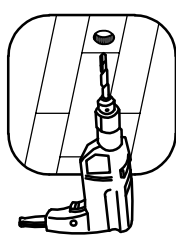

2.

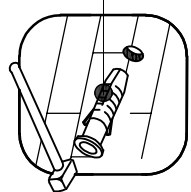

3.

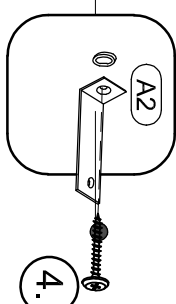

4.

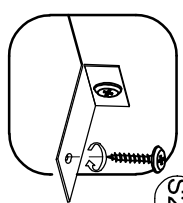

5.

**(M10)** M4x10 mm X 2

**(W1)** X 28

**(ST)** X 4

**(M25)** M4x25 mm X 2

**(S2-16L)** 4x16 mm X 2

**(PG)** 128 mm X 2

**(W4)** X 8

**(A2)** 60x20x15 mm X 2

**(C2)** X 34

**(PC)** Ø7/9x4mm X 2

**(PG)** **(M10)** **(PC)**

**Achtung:**

Modellname:

# BARCELONA

## MONTAGEANLEITUNG TYPE T12 - VITRINE-KOMBI

# 1/1

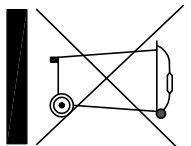

Das Symbol der durchgekreuzten Mülltonne bedeutet, dass elektrische sowie elektronische Teile nicht mit dem Hausmüll entsorgt werden dürfen. Bitte alle elektrischen/elektronischen Teile wie in der Aufbauanleitung gezeigt abmontieren und getrennt entsorgen.

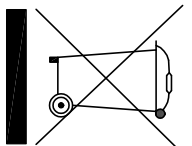

The crossed-out bin means that this product includes electrical and electronic pieces that must not be disposed of in the regular domestic waste. Please remove all electric/electronic equipment as described in the AI and dispose separately.

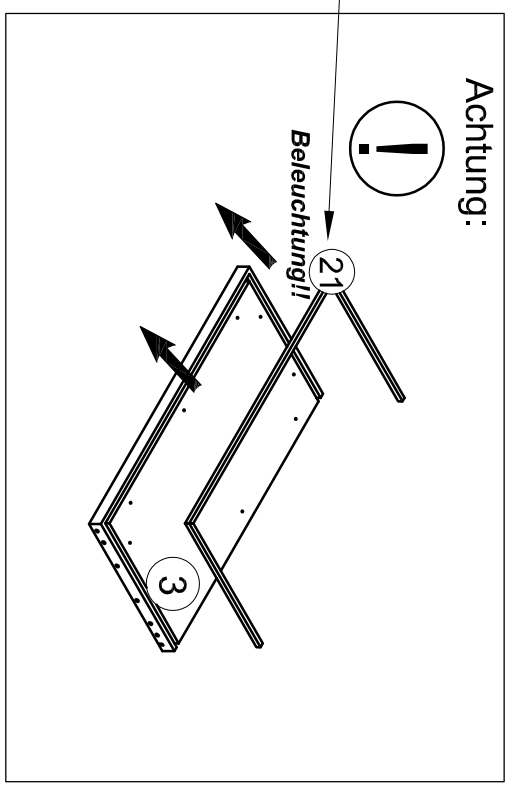
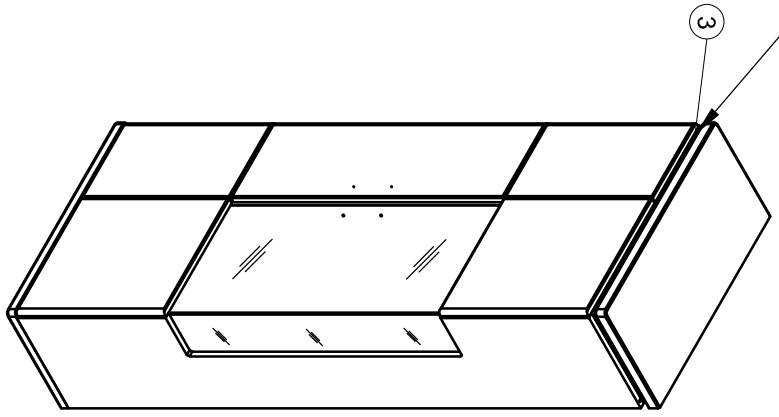

Modellname:

# BARCELONA

TYPE T12 - KOMBI VITRINE

# 2/2



1 Person

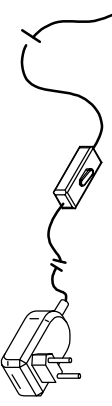
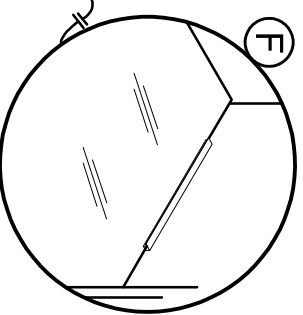
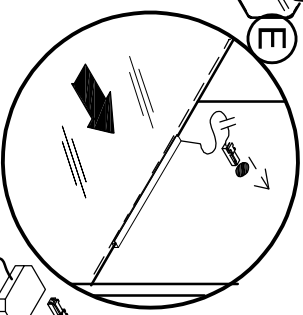
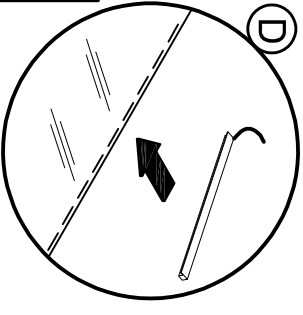
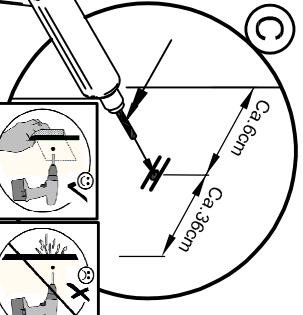
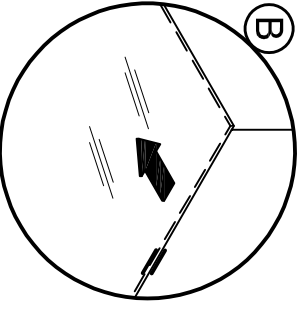
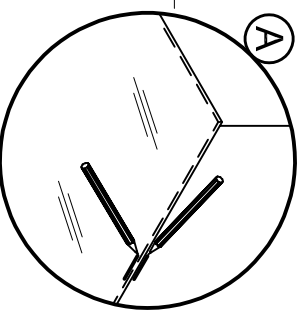
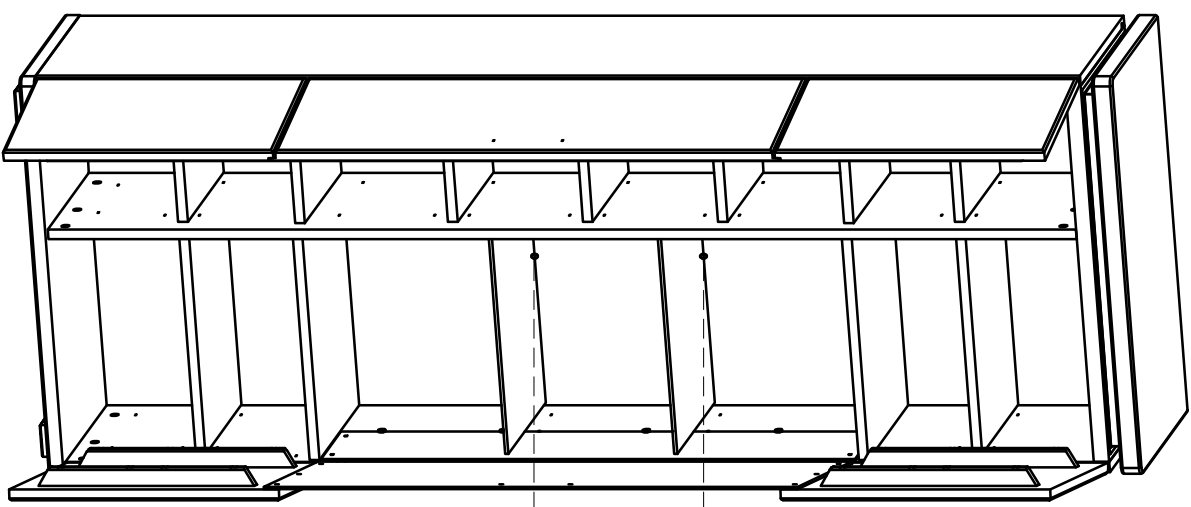
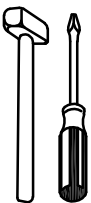
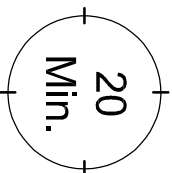

<b>OPTION</b>		
	0050522B_BEL.	X1
	0050522B_TRAFO	X1
	005091ZB	X1