

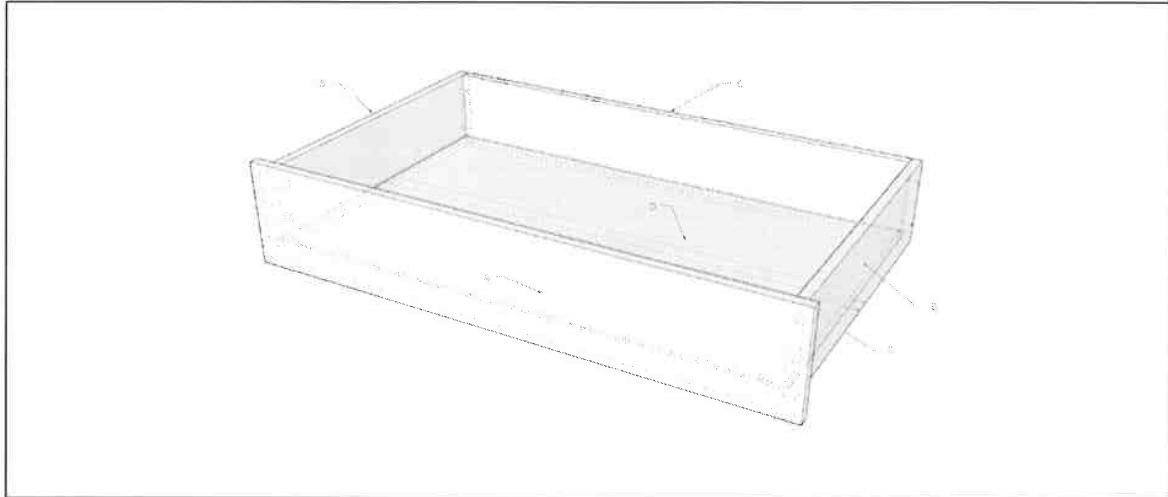



MONTAGEANLEITUNG BETTKASTEN BELLMUND





1	2	3	4
MaxFix 15mm	MaxFix M6	M4 50 mm	8mm
			
4pcs	4pcs	8pcs	8pcs

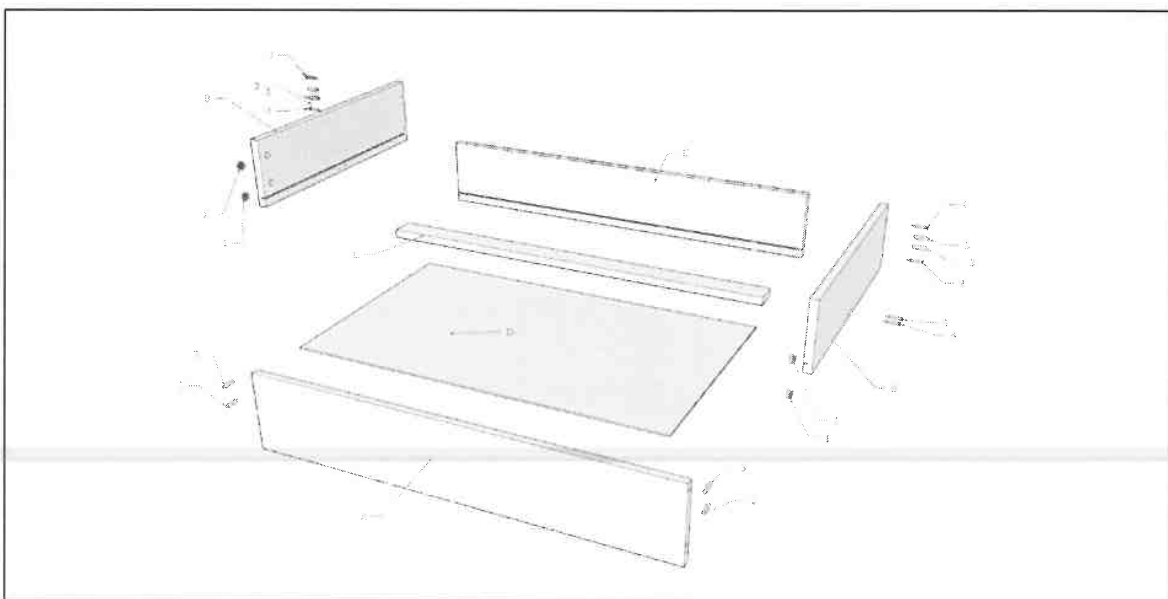

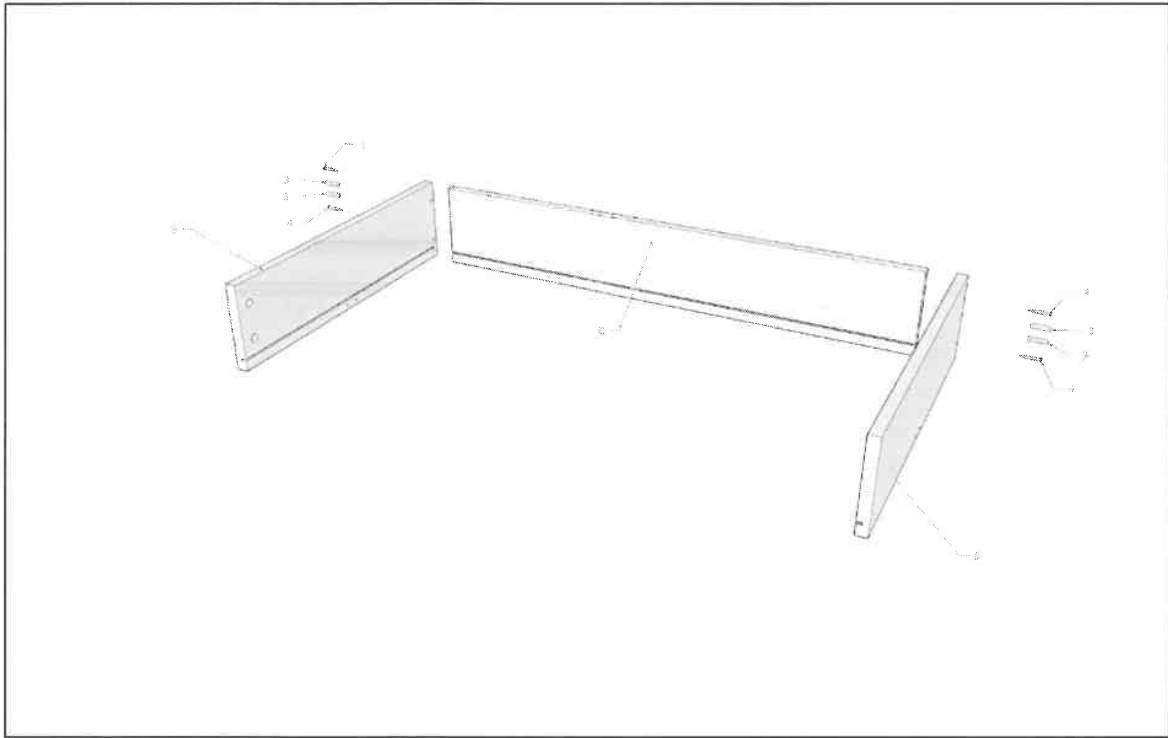
STEP 1



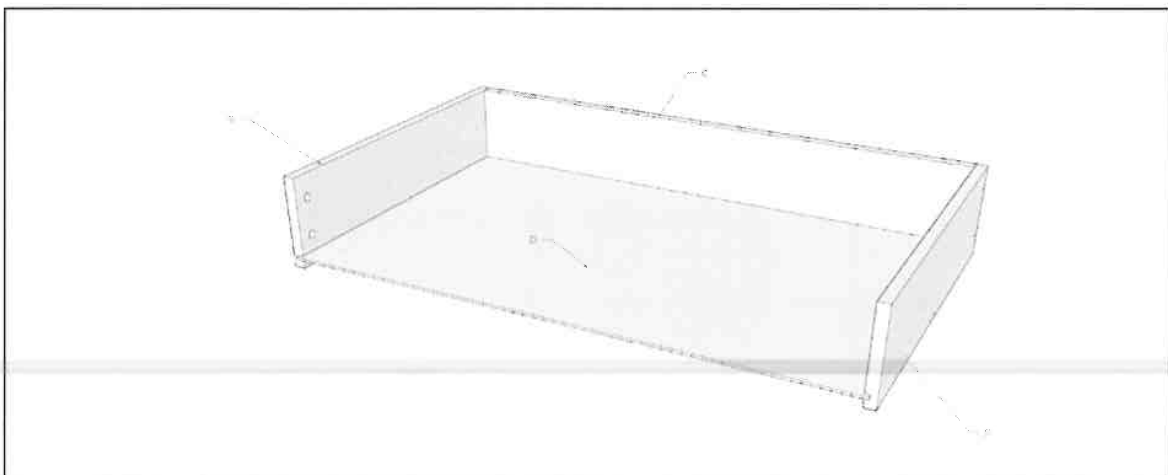

3	4
M4 50 mm	8mm
	
4pcs	4pcs



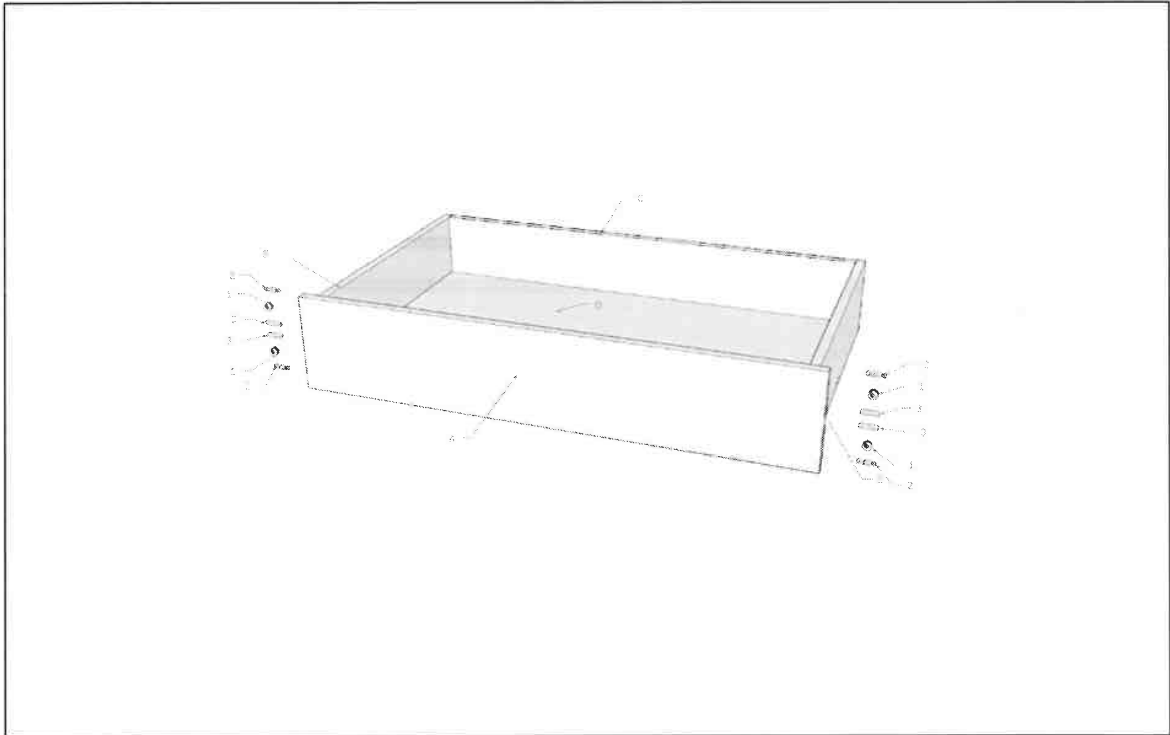

STEP 2

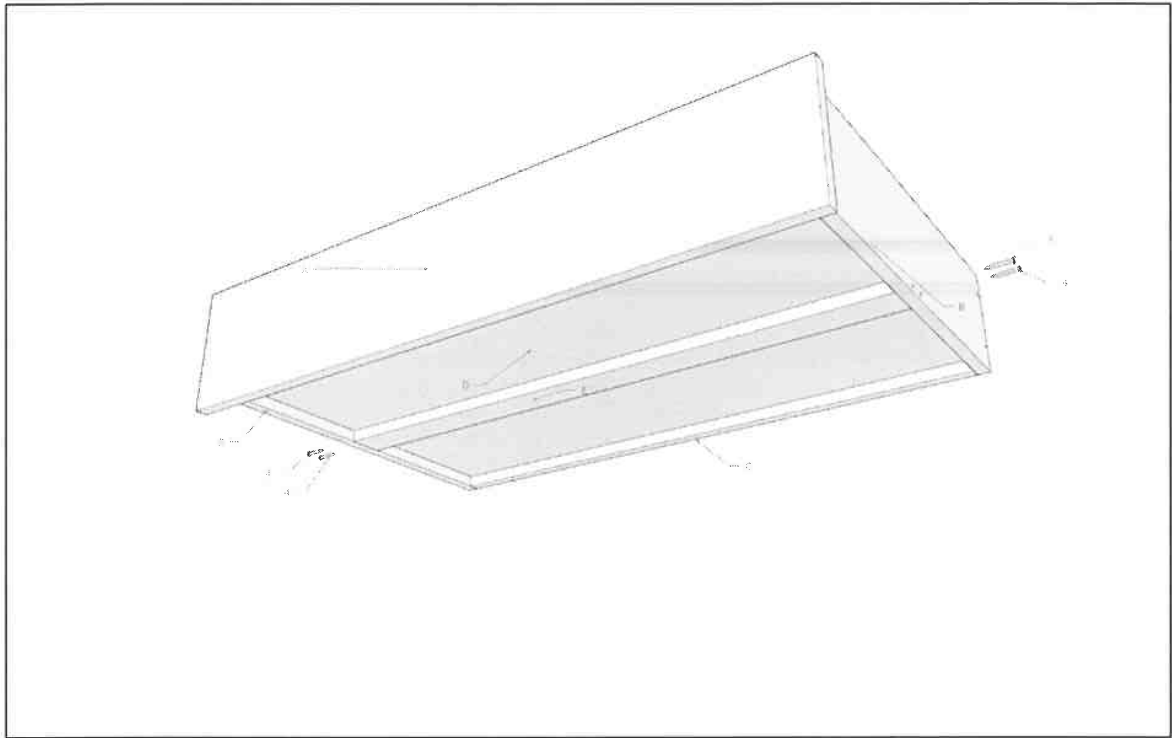

1	2	4
MaxFix 15mm	MaxFix M6	8mm
		
4pcs	4pcs	4pcs

STEP 3



3
M4 50 mm

4pcs

