

**D****Wichtige Pflegehinweise**

Bitte beachten Sie die wichtigen Pflegehinweise auf unserer Internetseite

www.held-hilft.de

Pflegehinweise

**PL****Ważne instrukcje dotyczące pielęgnacji**

Zwróć uwagę na ważną instrukcję dotyczącą pielęgnacji na naszej stronie internetowej

www.held-hilft.de

Pflegehinweise

**GB****Important care instructions**

Please note the important care instructions on our website

www.held-hilft.de

Pflegehinweise

**SK****Dôležité pokyny na starostlivosť**

Dbajte na dôležité pokyny týkajúce sa starostlivosti na našich webových stránkach

www.held-hilft.de

Pflegehinweise

**FR****Instructions d'entretien importantes**

S'il vous plaît noter les instructions de soins importants sur notre site Web

www.held-hilft.de

Pflegehinweise

**HU****Fontos kezelési utasítások**

Kérjük, vegye figyelembe a honlapunkon található fontos kezelési útmutatót

www.held-hilft.de

Pflegehinweise

**IT****Importanti istruzioni per la cura**

Si prega di notare le importanti istruzioni per la cura sul nostro sito web

www.held-hilft.de

Pflegehinweise

**RO****Instrucțiunile importante de îngrijire**

Rețineți instrucțiunile importante de îngrijire de pe site-ul nostru

www.held-hilft.de

Pflegehinweise

**NL****Belangrijke zorginstructies**

Let op de belangrijke zorginstructies op onze website

www.held-hilft.de

Pflegehinweise

**TR****Önemli bakım talimatları**

Lütfen web sitemizdeki önemli bakım talimatlarını dikkate alınız

www.held-hilft.de

Pflegehinweise

**CZ****Důležité pokyny pro péči**

Vezměte prosím na vědomí důležité pokyny pro péči na našich webových stránkách

www.held-hilft.de

Pflegehinweise

**RU****Важные инструкции по уходу**

Обратите внимание на важные инструкции по уходу на нашем веб-сайте

www.held-hilft.de

Pflegehinweise



88470.110

14-08-2017

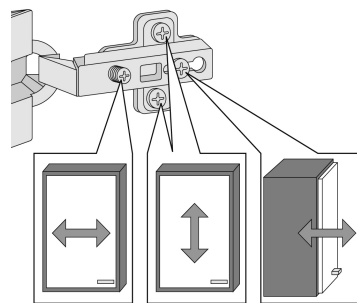
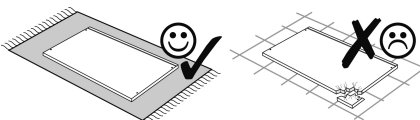
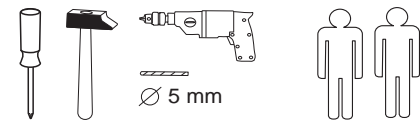

1 4 x 2802	2 4 x 2801	3 2 x 1601	4 2 x 1610	5 8 x 2861
6 4 x 2821	7 10 x 2862	8 2 x 1610	9 4 x 2812	10 4 x 2812
11 2 x 2840	12 2 x 2842	13 2 x 2843	14 4 x 2865	15 2 x 2855
16 4 x 2815	17 2 x 5254	18 2 x 2835	19 2 x 2829	20 4 x 2552
21 1 x 2863	0 10 20 30 40			

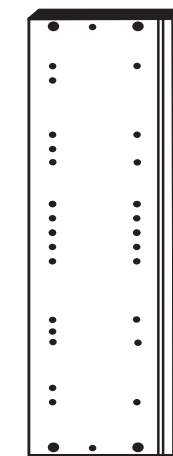

22 2 x



27 1 x



30 1 x

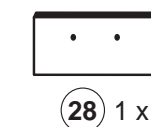

28 1 x



26 1 x

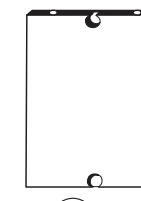

23 2 x

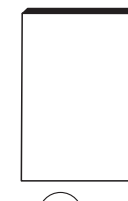

24 1 x

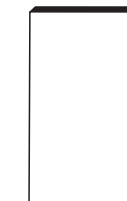

25 1 x



29 1 x

Das beigelegte Wandbefestigungsmaterial (Dübel und Schrauben) eignet sich nur für festes Mauerwerk (z.B.: Beton- oder Ziegelwände). Für andere Wandaufbauten sind eventuell Spezialdübel und andere Schrauben notwendig. Ziehen Sie gegebenenfalls eine Fachkraft zu Rate.

De begeleidende wandmontage hardware (pluggen en schroeven) is alleen geschikt voor massief metselwerk (bijvoorbeeld beton of bakstenen muren). Voor andere muur structuren zijn eventueel bijzondere ankerbouten en andere noodzakelijke. Draai indien nodig, een deskundige.

Приложенный материал для крепления к стене (дюбели и винты) пригоден только для жестких кладок (например, бетонные или кирпичные стены). Для других настенных конструкций необходимы смотря по обстоятельствам специальные дюбели и другие винты. При необходимости проконсультируйтесь у специалиста.

Le mur d'accompagnement matériel de montage (chevilles et les vis) ne convient que pour la maçonnerie solide (par exemple en béton ou des murs de briques). Pour les structures de mur d'autres sont peut-être spéciale boulons d'ancrage et d'autres nécessaires. Serrer le cas échéant, un expert.

Załączony materiał do mocowania do ściany (kołki rozprężne i wkręty) nadaje się tylko do ścian murowanych (np. z betonu lub cegieł). Do ścian wykonanych w innych technologiach konieczne być mogą specjalne kołki rozprężne i inne wkręty. W razie potrzeby skorzystaj z fachowej pomocy.

Il muro di accompagnamento hardware di montaggio (tasselli e viti) è adatto solo per muratura piena (ad esempio calcestruzzo o muratura). Per le altre strutture murarie sono forse speciali bulloni di ancoraggio e necessari di altri. Serrare se necessario, un esperto.

The accompanying wall mounting hardware (anchors and screws) is suitable only for solid masonry (eg concrete or brick walls). For other wall structures are possibly special anchor bolts and other necessary. Tighten if necessary, an expert.

Ekteki duvara sabit montaj malzemeleri (dübel ve vidalar), sadece sağlam duvarlar için (örnek: beton veya tuğla) elverişlidir. Başka duvarlar için özel dübeller ve farklı vidalar gerekebilir. Gerektiğinde bir bilene danışınız.

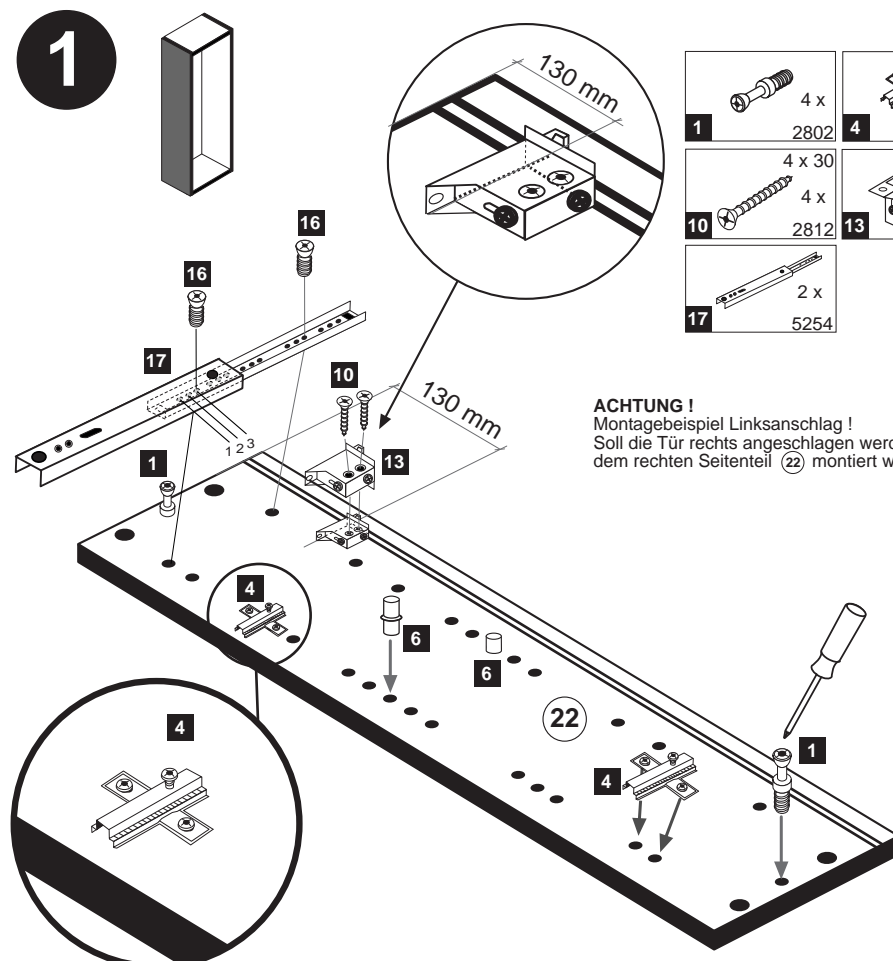

ACHTUNG!
Montagebeispiel Linksanschlag!
Soll die Tür rechts angeschlagen werden müssen die Kreuzmontageplatten 4 auf dem rechten Seitenteil (22) montiert werden.

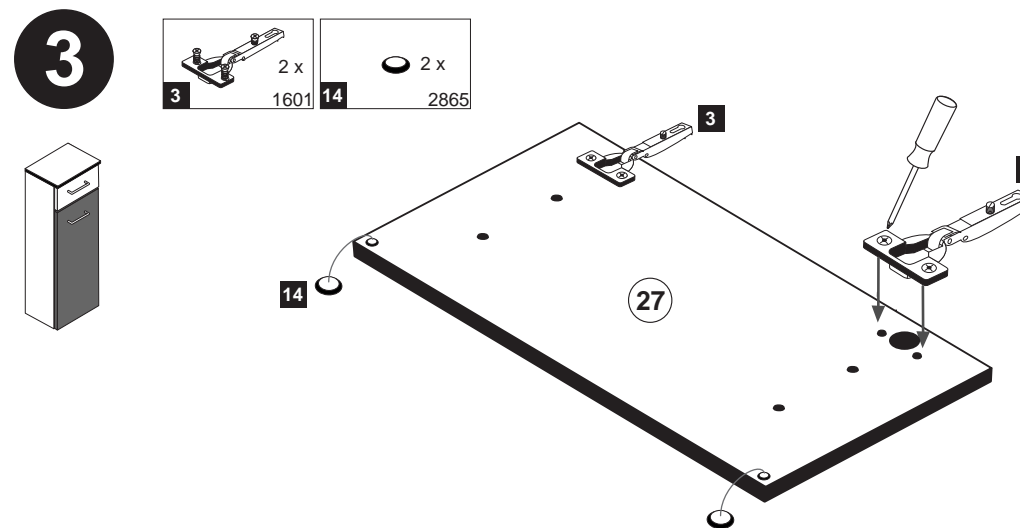
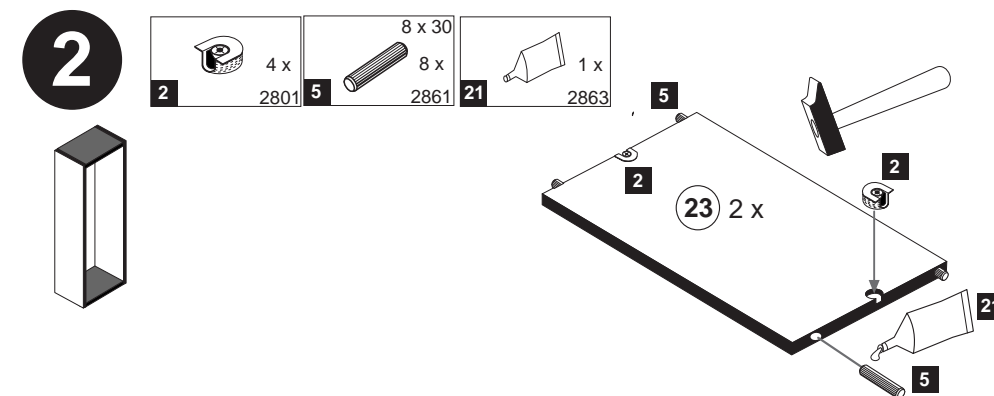
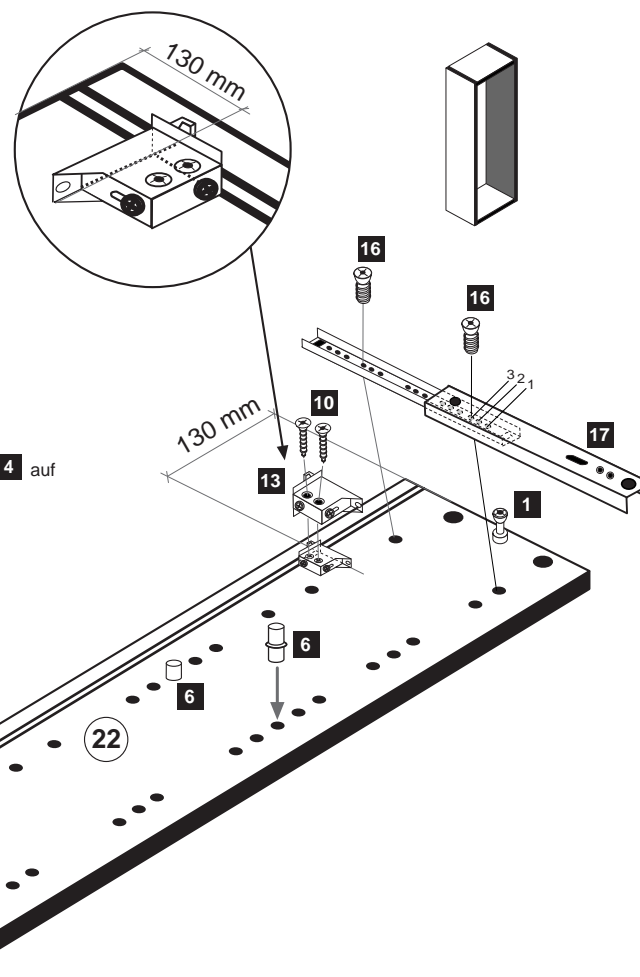

4

21 1 x 2863

20 min.

D Leim
GB Glue
NL Lijm
PL Klej
TR Tutkal
F Colle
I Colla

5

7 10 x 2862

6

20 4 x 2552

7

19 4 x 27 2 x 2829

1. \varnothing 5 mm

2.

8

2. \varnothing 5 mm

9

8 1 x 9 4 x 22/25 2 x 14 2 x 2865 21 1 x 2863

10

ACHTUNG!
Montagebeispiel Linksanschlag!
Bei Rechtsanschlag andere Griffbohrung durchbohren!

2. \varnothing 5 mm

1.

11

18 4 x 9 2 x 2835

12

8 1 x 9 4 x 22/25 2 x 15 8 x 5 2 x 2855

13

11 5,8 x 55 2 x 2840 12 8 x 30 2 x 2842



1 4551

