

# LUCERA

ST 32

Art.Nr. 70-036-C0

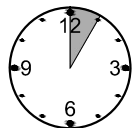
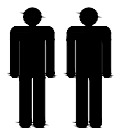
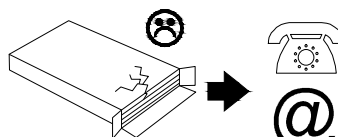
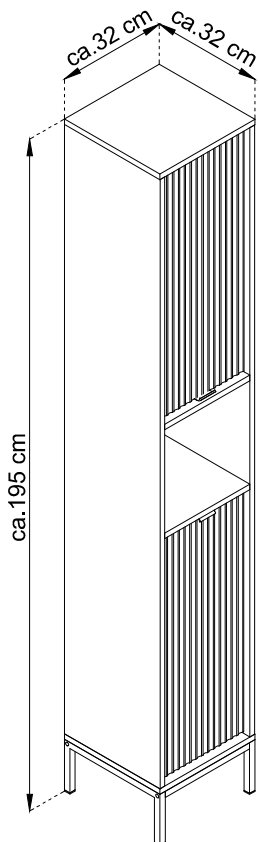
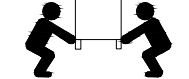
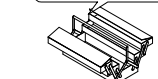
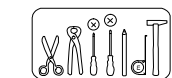
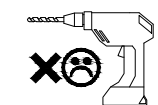
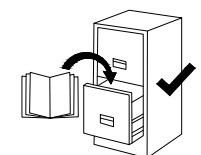
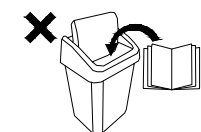
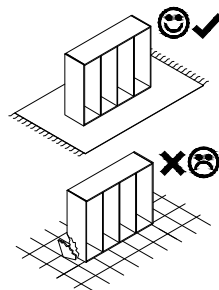
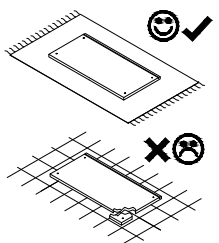

ca.1H

- (D) Montageanleitung
- (FR) Notice de montage
- (NL) Handleiding voor de montage
- (CZ) Montážní návod
- (HU) Szerelési útmutató
- (TR) Montaj talimati

- (GB) Assembly Instructions
- (IT) Istruzioni di montaggio
- (PL) Instrukcja montażu
- (SK) Návod na montáž
- (RO) Instrucțiuni de montaj
- (RU) Инструкции по монтажу

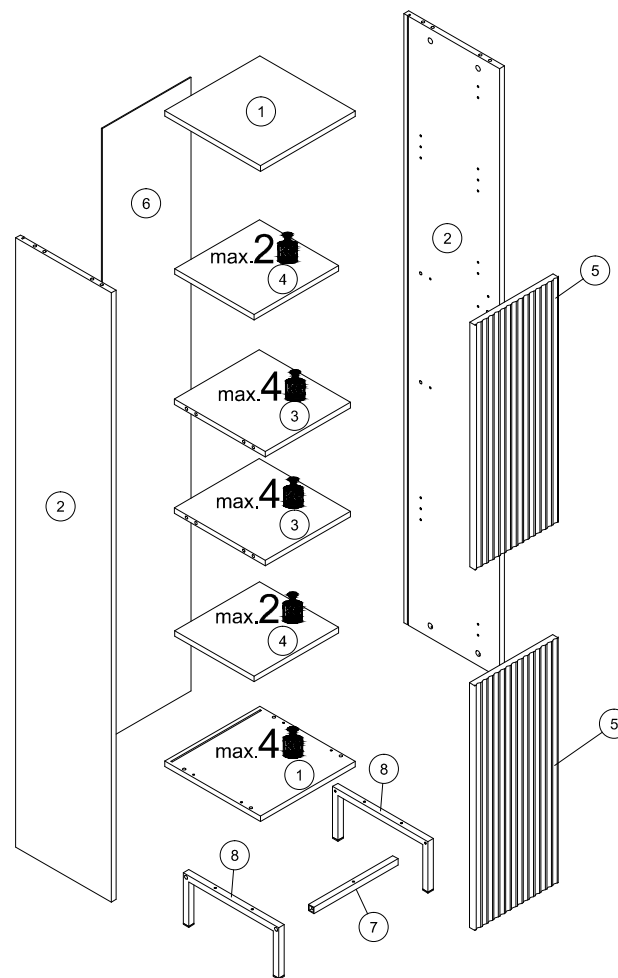

IMB1 x1	SI x2	ZST x2		
A 8x32 x16	TA x1	ND 3.5x16 x1	N 3x20 x10	SLS x4
B x16	C x16	Z x16	W+H2 x4	ZZ x8
NS 3.5x13 x12	X x14	NE 4x16 x5	R6 x2	ZE x2

max. = 16 kg.

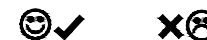

1	318	320	16	x2	1 / 1
2	1768	320	16	x2	1 / 1
3	305	285	16	x2	1 / 1
4	284	265	16	x2	1 / 1
5	710	279	18	x2	1 / 1
6	1780	297	3	x1	1 / 1
7	300	18	18	x1	1 / 1
8	320	150	18	x2	1 / 1

11.04.2022

! **Uwaga • Upozornění • Achtung • Attention • Caution • Figyelem**  
**Attenzione • Opgelet • Внимание • Atenție • Upozornenie • Dikkat** !

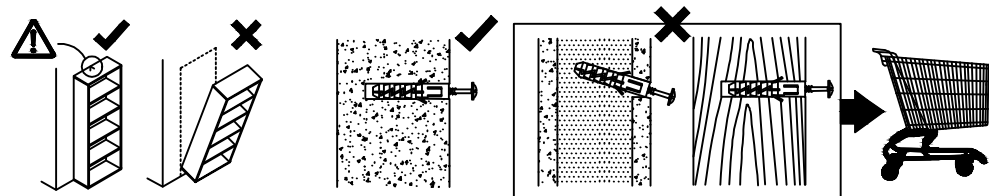
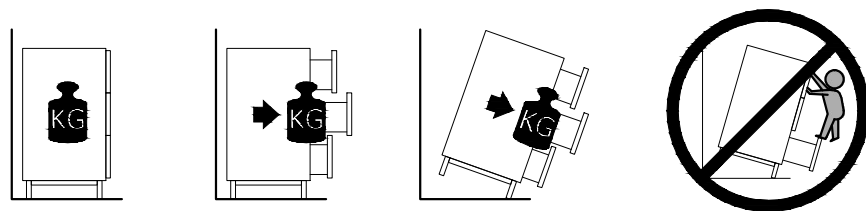

! **Uwaga • Upozornění • Achtung • Attention • Caution • Figyelem**  
**Attenzione • Opgelet • Внимание • Atenție • Upozornenie • Dikkat** !

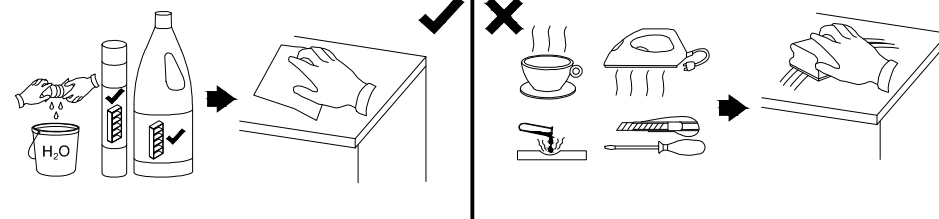
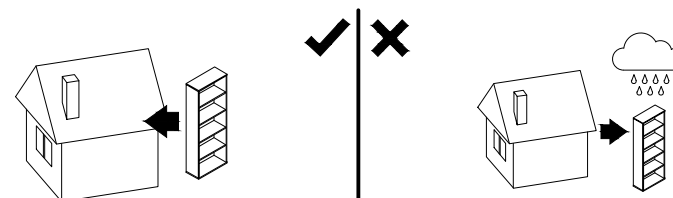



PL	Mocowanie do ściany jest jednocześnie zabezpieczeniem przed przewróceniem - koniecznie zamontować! Do niektórych rodzajów ścian koniecznie zastosować specjalne kołki mocujące.
CZ	Montáž na stěnu slouží jako ochrana proti převrnutí - bezpodmínečně umístěte! U některých typů stěn může být zapotřebí speciální hmoždinka!
DE	Wandbefestigung dient als Kippschutz - unbedingt anbringen! bei einigen Wandtypen kann ein Spezialdübel erforderlich sein!
GB	The wall fastening serves to prevent tipping - be absolutely sure to mount it! For certain wall types, a special wall plug may be necessary!
FR	La fixation murale sert de protection contre le basculement - à installer impérativement! Pour certains types de murs il faut des chevilles spéciales!
NL	Bevestiging aan de muur dient als kantelbescherming - zeker en vast bevestigen! Bij enkele muurtypen is een speciale plug misschien vereist!
IT	Il fissaggio alla parete serve da protezione anti-ribaltamento-attaccarla assolutamente! Per alcune strutture di parete può essere necessario un tassello speciale!
HU	A termék a falhoz kel rögzíteni, különben az felborulhat! Egyes faltípusoknál speciális tiplít kell használni!
RU	Обязательно установите крепление на стене во избежание опрокидывания! Для некоторых типов стен может потребо- ваться специальный дюбель!
RO	Sistemul de fixare la perete servește ca protecție la răsturnare - de montat obligatoriu! Pentru unele tipuri de pereți este posibil să fie necesar un diblu special!
SK	Upevnenie ne stenu slúži ako ochrana proti prevráteniu - bezpodmienečne použite! Pre niektoré druhy stein môže byť potrebná špeciálna hmoždinka!
TR	Duvardaki sabitleme, devrilmeye karşı bir emniyet tedbiridir ve mutlaka monte edilmelidir! Bazı duvar tiplerinde bunun için özel bir dübel gerekli olabilir!

PL	Czyszczenie należy wykonać wyłącznie za pomocą ściereczki lub lekko nawilżonego ręcznika. Nie stosować środków czyszczących do szorowania.
CZ	Čistění je nutné vykonávat výhradně pomocí utěrky nebo lehce navlhčeného ručníku. Nepoužívejte čističe obsahující abrazivní částice.
DE	Bitte nur mit einem Staubtuch oder leicht feuchtern Lappen reinigen. Keine scheuernden Putzmittel verwenden.
GB	Please only clean with a duster or damp cloth. Do not use any abrasive cleaners.
FR	Le nettoyage se fait uniquement à l'aide d'un torchon ou d'une serviette légèrement mouillée.
NL	Reinig alleen met een stofdoek of een lichtjes vochtige doek. Gebruik geen schurende poetsmiddelen.
IT	Pulire esclusivamente con un panno o un asciugamano umido.
HU	A tisztítás kizárólag törölruha vagy enyhén nedvesített törölköző segítségével végezhető. Súroló hatású tisztítószereket nem szabad használni.
RU	Очищайте от пыли тряпкой или слегка влажной ветошью. Не допускается применение чистящих средств, не предназначенных для ухода за мебелью.
RO	Curățarea trebuie efectuată numai cu o cârpă sau cu un prosop ușor umezit. Nu utilizați agenți de curățare abrazivi.
SK	Čistení je nutné vykonávať výhradne pomocí utierky alebo ľahko zvlhnutým ručníkom. Nepoužívajte čistiaci prostriedky obsahujúci abrazívni častice.
TR	Lütfen sadece bir toz bezilye veya hafif nemli yumuşak bir bezle siliniz. Aşındırıcı temizlik malzemeleri kullanmayınız.

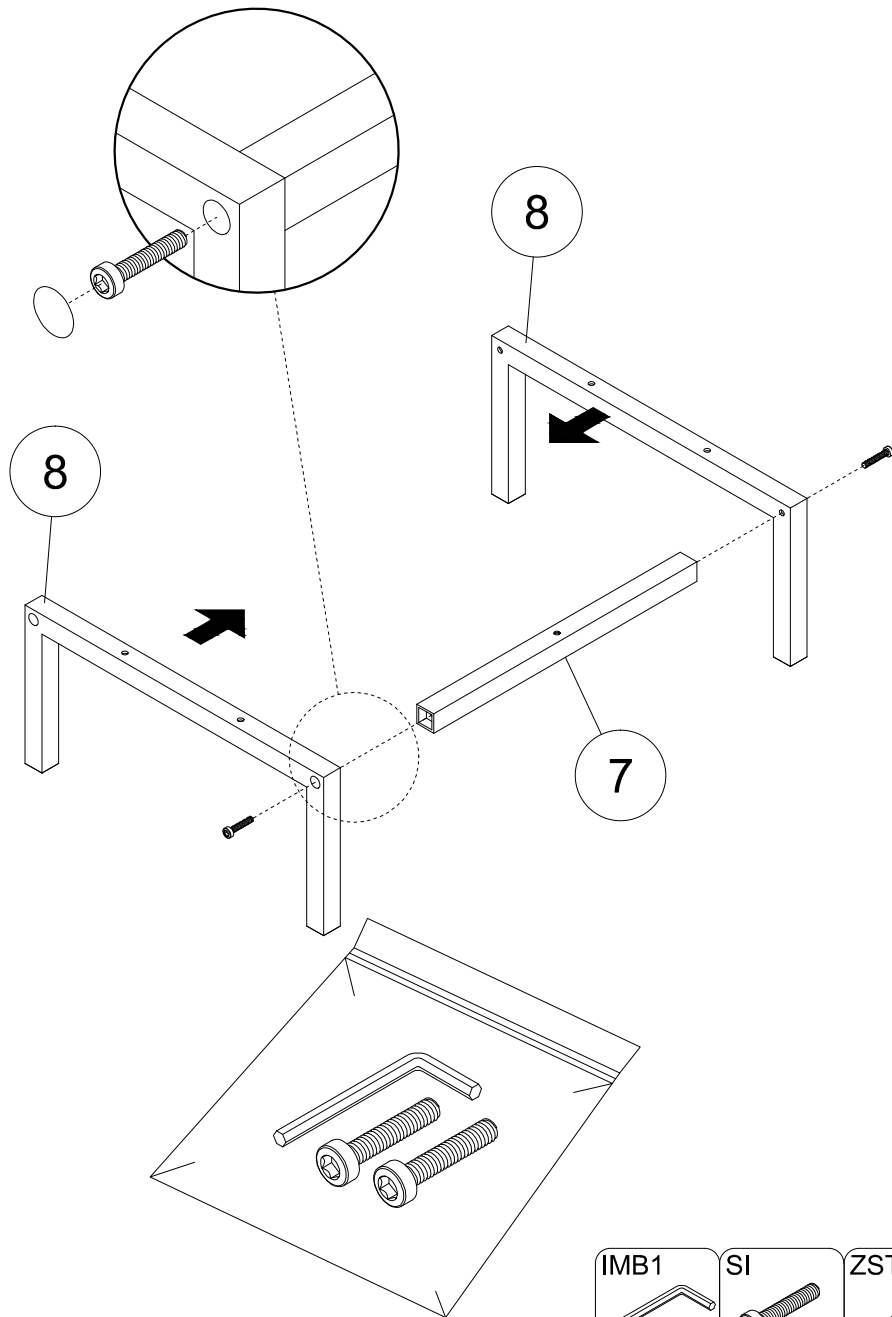

1

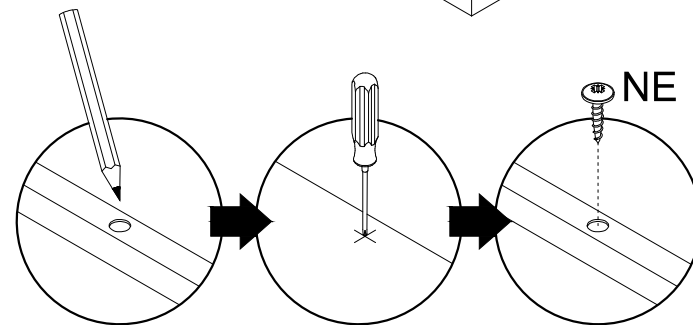
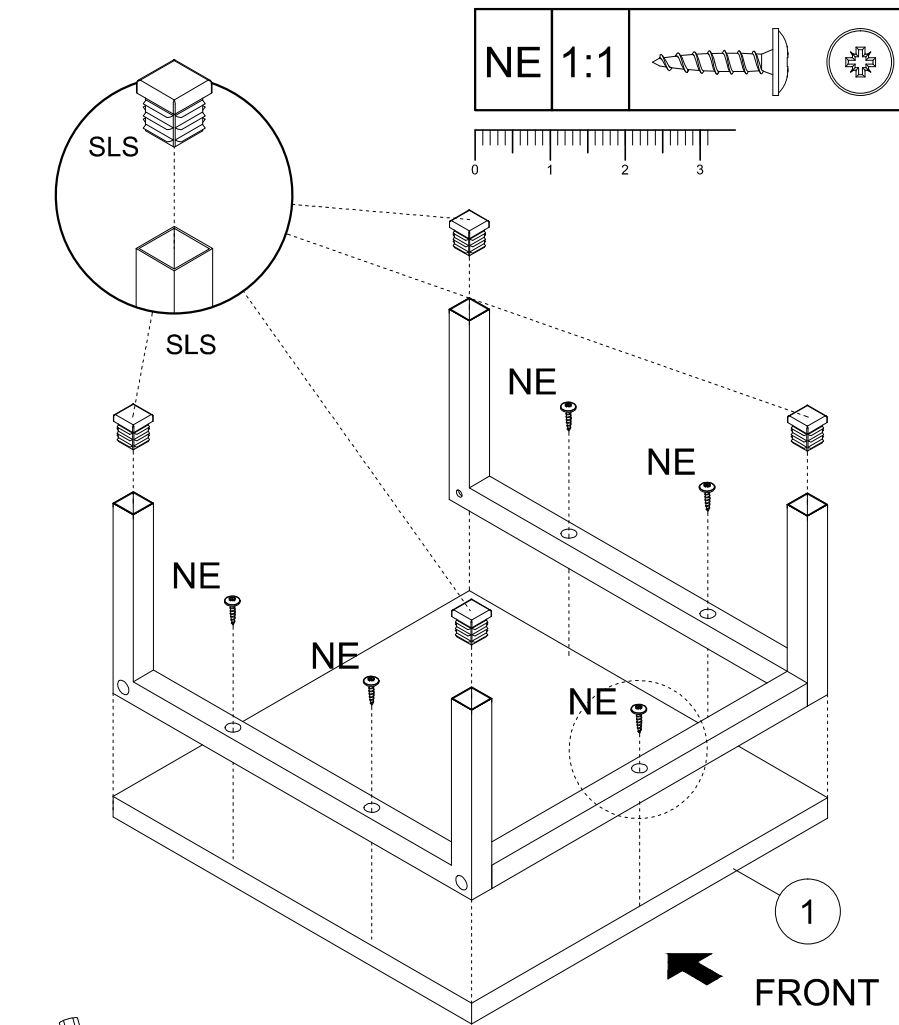

IMB1  x1	SI  x2	ZST  x2
---	---	--

2



SLS  x4	NE 4x16  x5
--	--

3

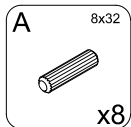
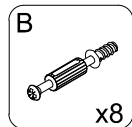
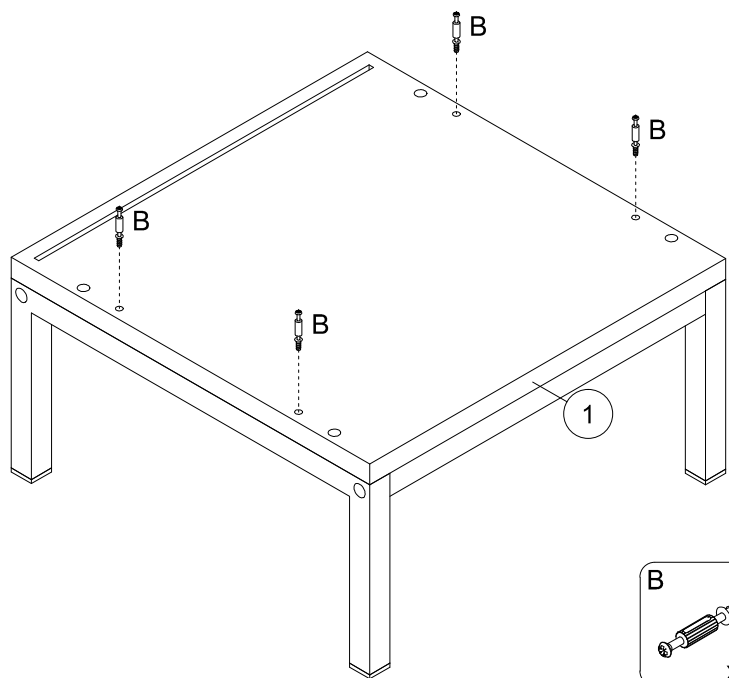
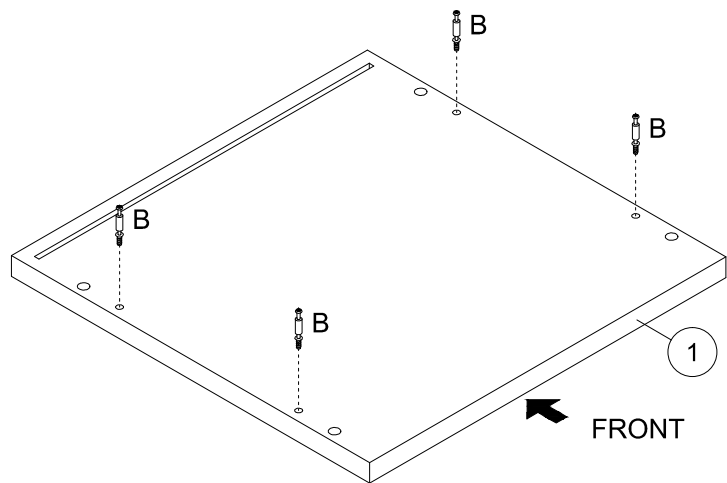
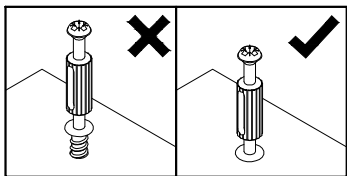

4

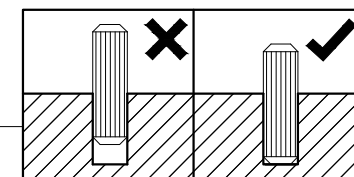
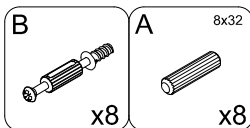
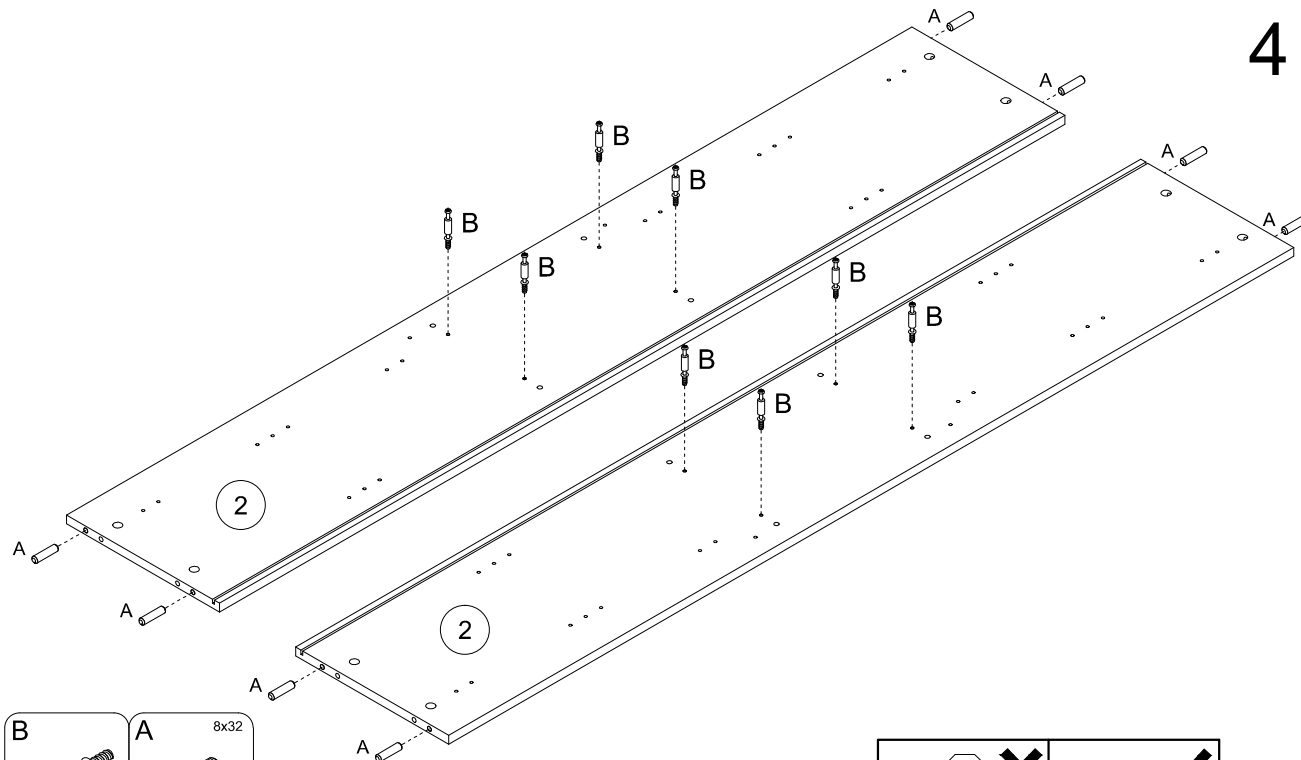

5

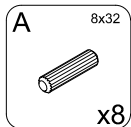
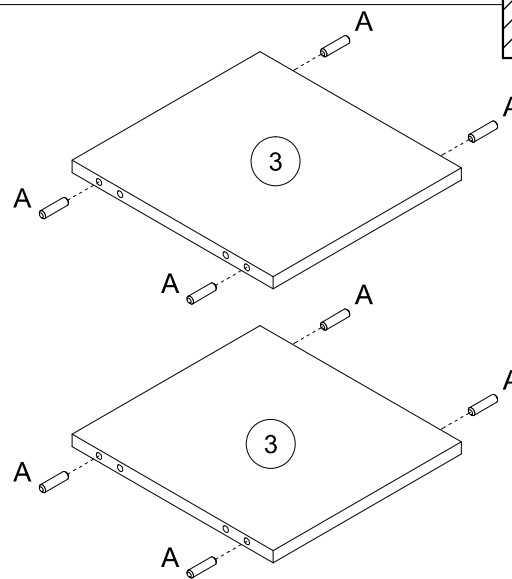

6

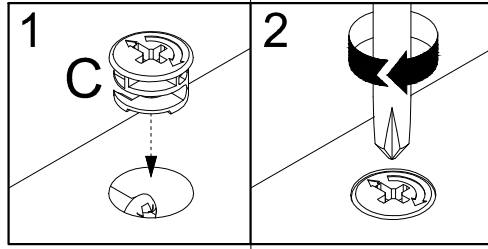

7

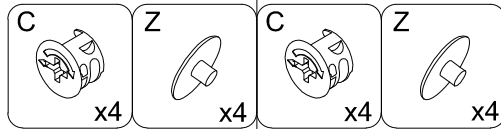
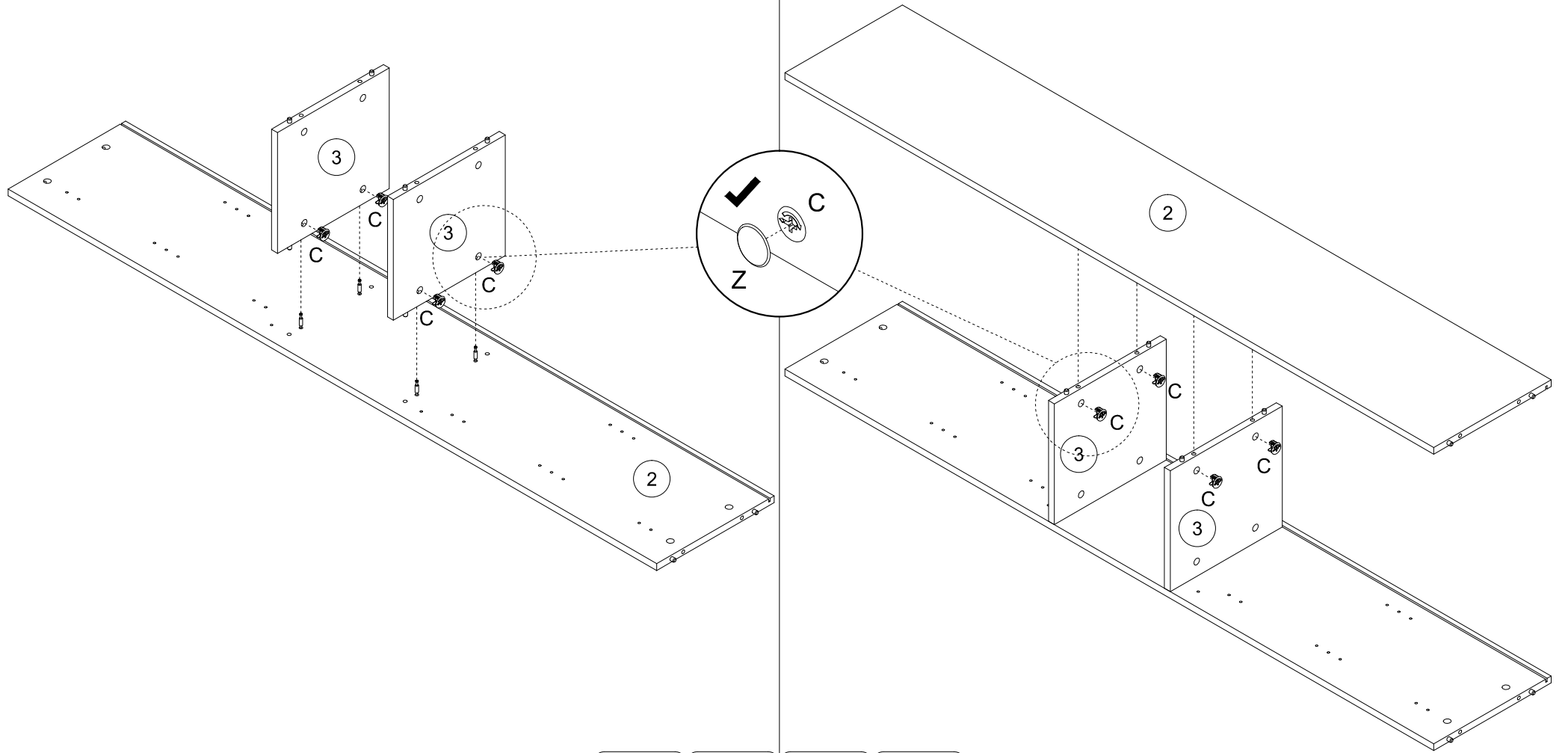

8

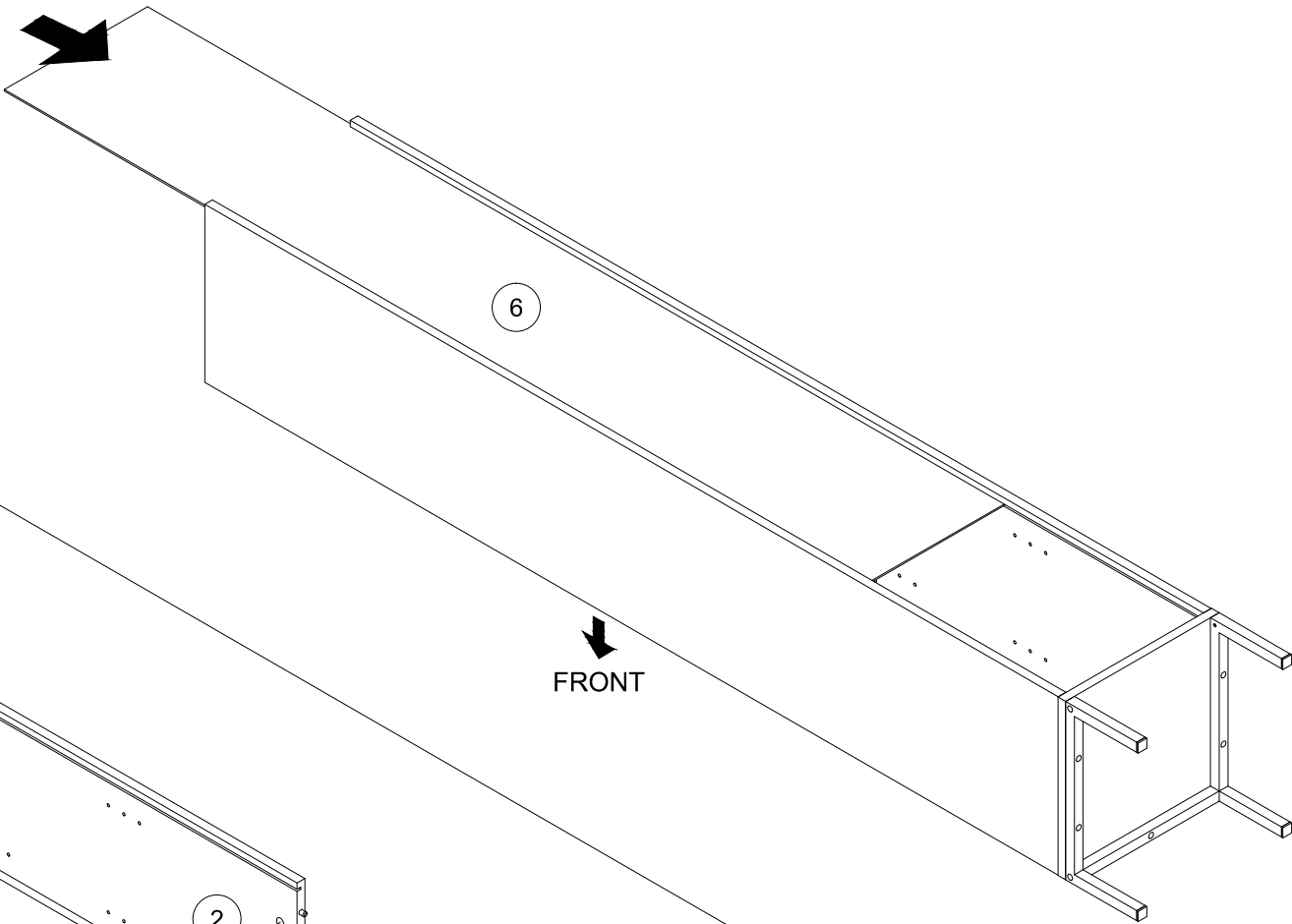

FRONT

FRONT

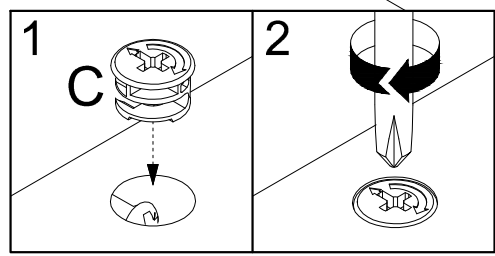
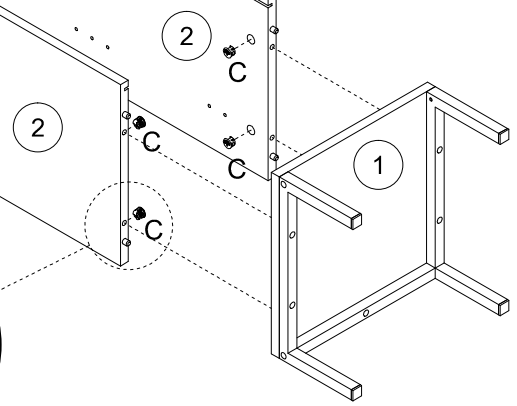
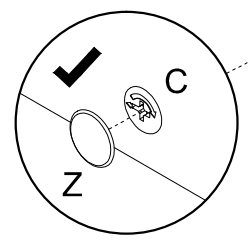
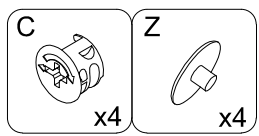

10

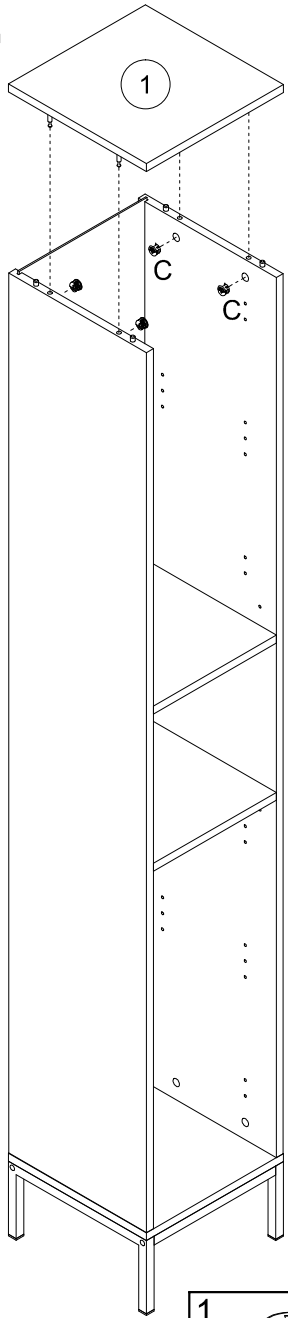

11

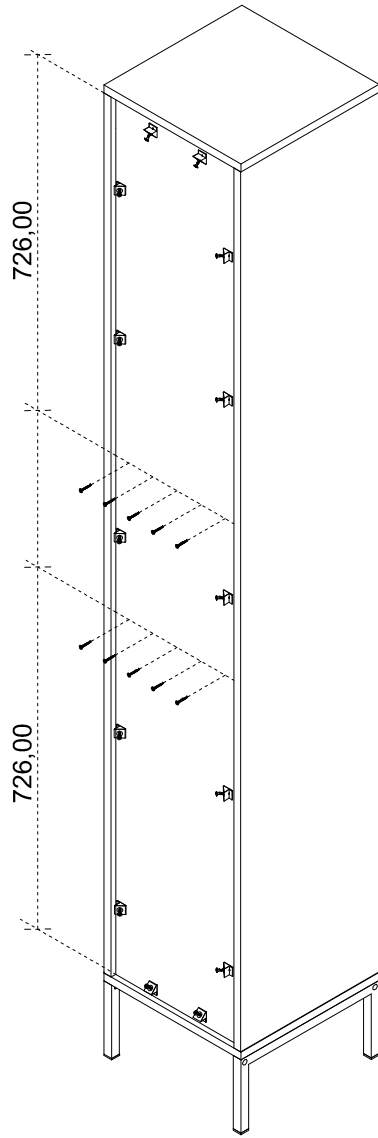
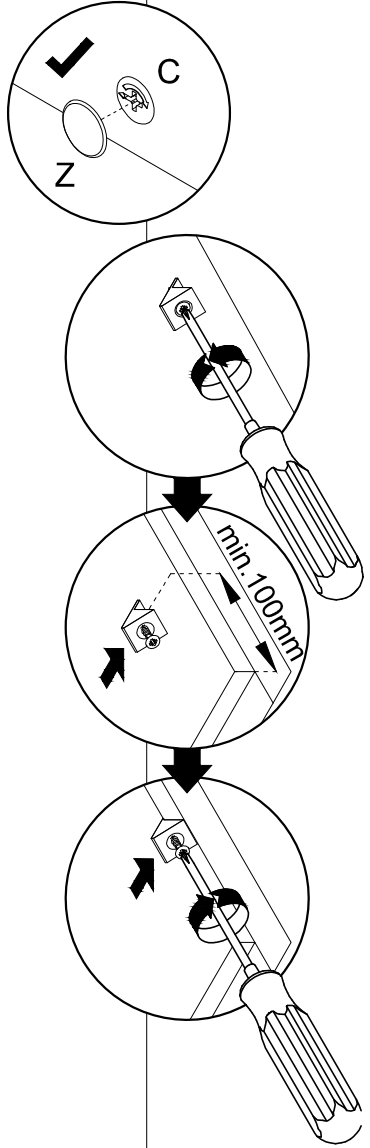

12

R

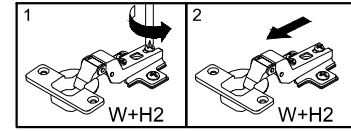
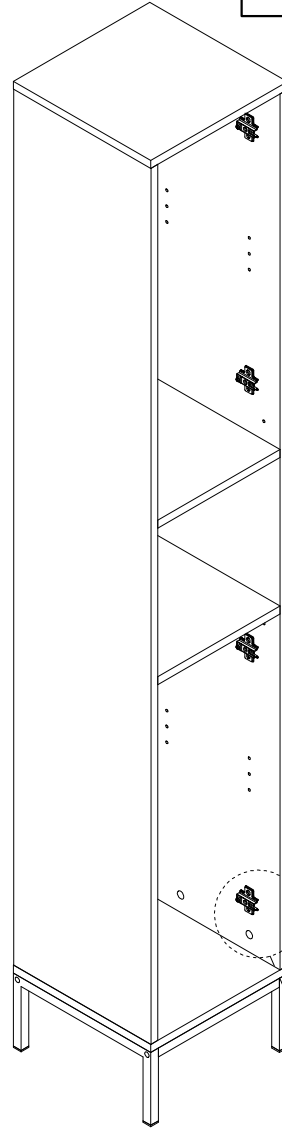

L

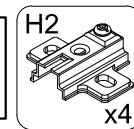
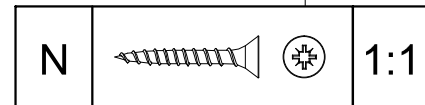
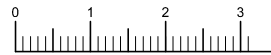
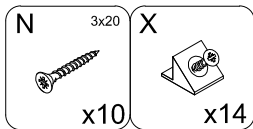
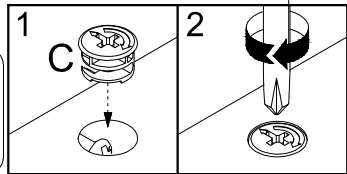
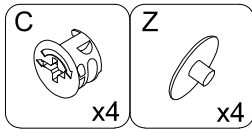
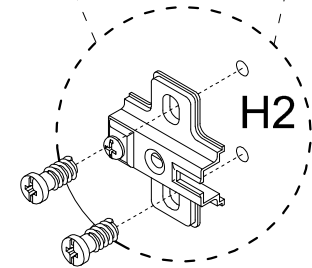
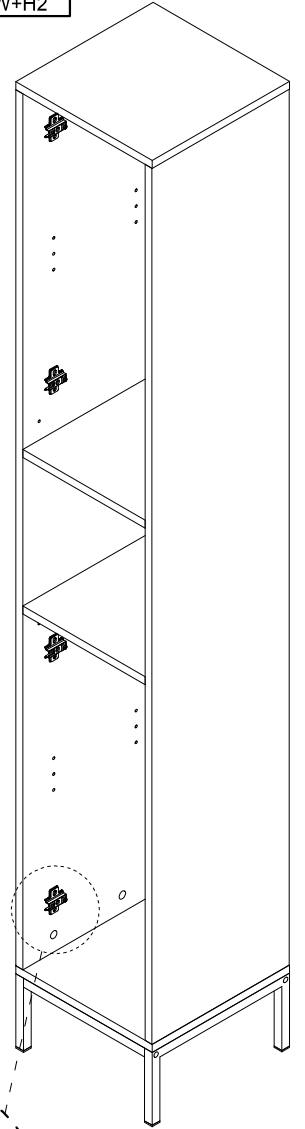

13

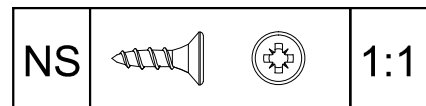
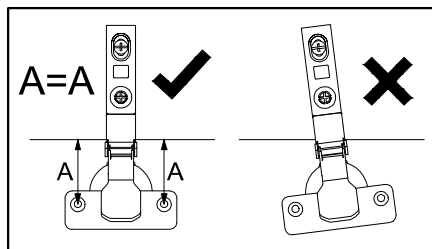

PROTECTIVE

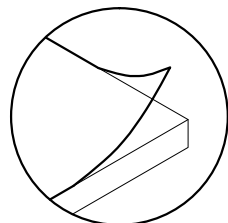

FOIL

ZE

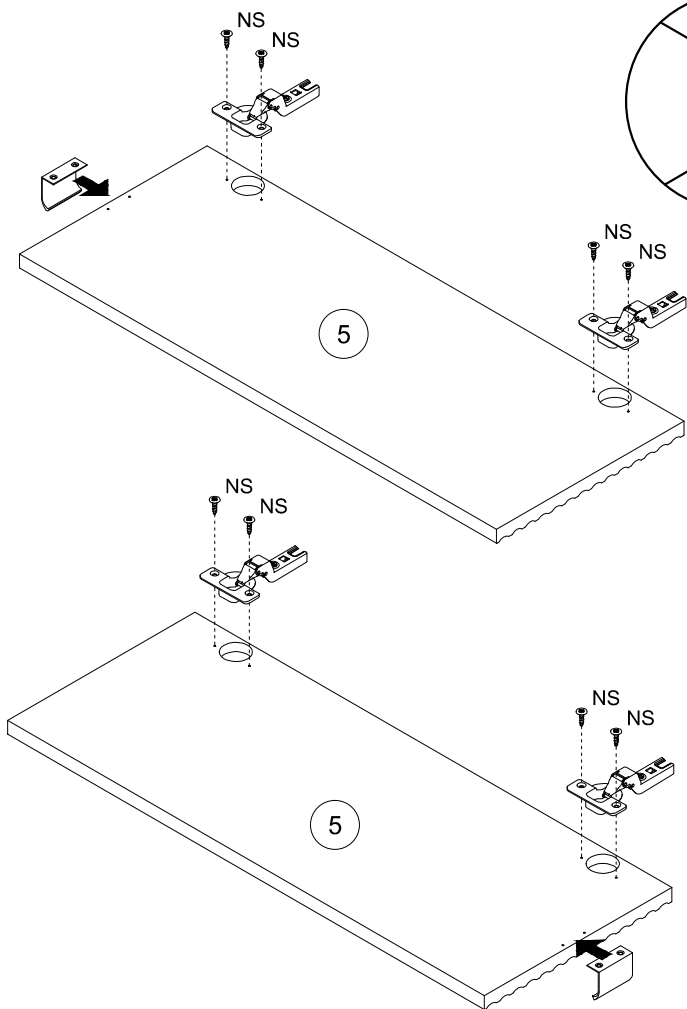
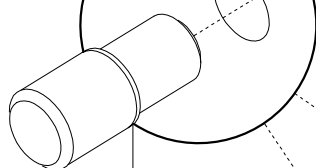

R6

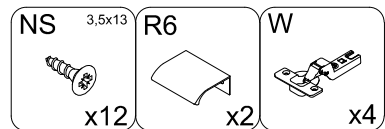
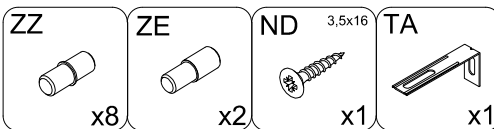
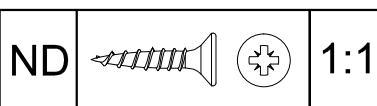
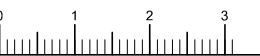
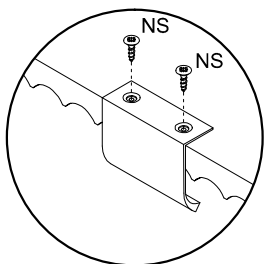
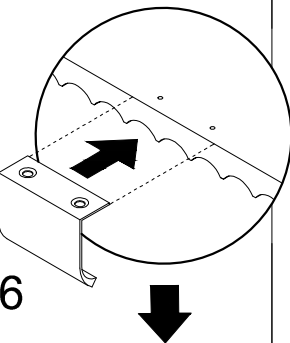

14

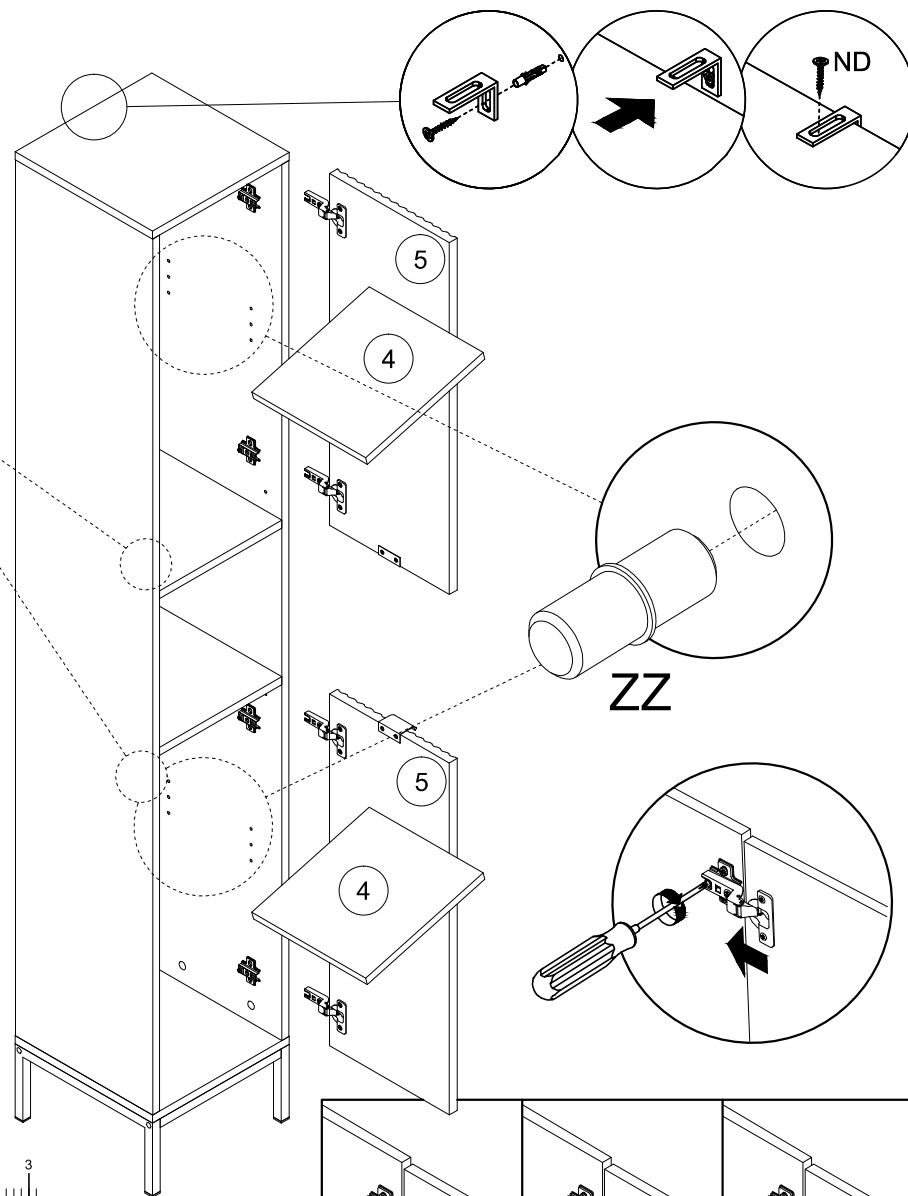

ZZ

