

# TICINO

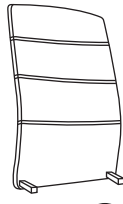

(A) x1

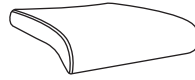

(B) x1

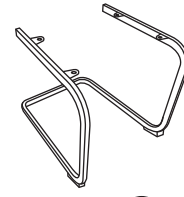

(C) x1

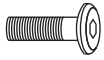

M6x16mm

(1) x4



M6x12mm

(2) x4



(3) x4

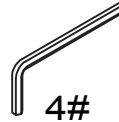

4#

(4) x1

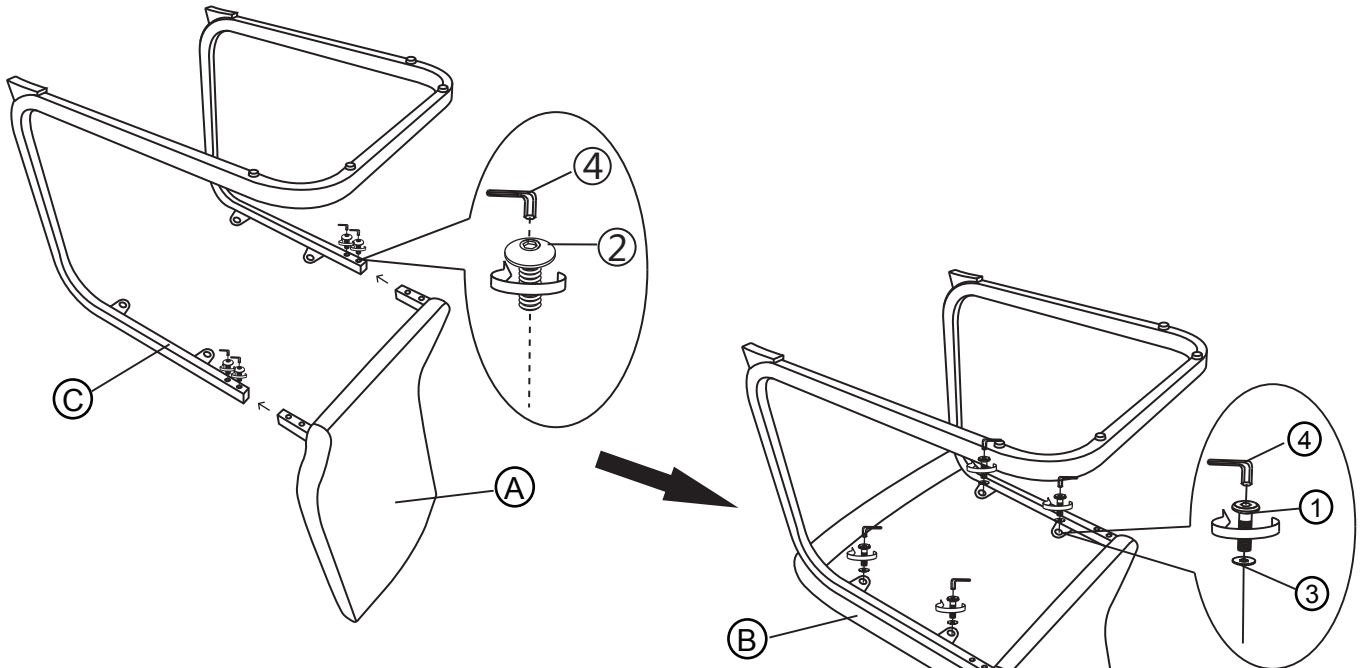

- D - Bitte Überprüfen Sie in regelmäßigen Abständen den festen Sitz der Schrauben.  
 D - Bitte nur mit einem Staubtuch oder feuchten Tuch abwischen.  
 GB - Please check the tightness of the screws at regular intervals.  
 GB - Please only wipe with a duster or damp cloth.  
 F - Veuillez vérifier à intervalles réguliers que les vis sont bien serrées.  
 F - Veuillez l'essuyer uniquement avec un chiffon à poussière ou un chiffon humide.  
 ES - Compruebe periódicamente el apriete de los tornillos.  
 ES - Límpiela sólo con un plumero o un paño húmedo.  
 IT - Controllare il serraggio delle viti a intervalli regolari.  
 IT - Pulire solo con uno spolverino o un panno umido.  
 PL - Proszę w regularnych odstępach czasu sprawdzać dokręcenie śrub.  
 PL - Proszę przecierać tylko ściereczką do kurzu lub wilgotną.  
 NL - Controleer regelmatig of de schroeven goed vastzitten.  
 NL - Alleen afnemen met een stofdoek of vochtige doek.  
 S - Kontrollera att skruvarna är ordentligt åtdragna med jämna mellanrum.  
 S - Torka endast av med en dammvippa eller en fuktig trasa.  
 SK - V pravidelných intervaloch kontrolujte dotiahnutie skrutiek.  
 SK - Uterajte iba prachovkou alebo vlhkou handričkou.  
 SL - V rednih časovnih presledkih preverjajte zategnjenost vijakov.  
 SL - Obrišite ga le s krpo za prah ali vlažno krpo.  
 HR - Redovito provjeravajte cvrsto naljezanje vijaka.  
 HR - Brišite samo krpom za prašinu ili vlažnom krpom.

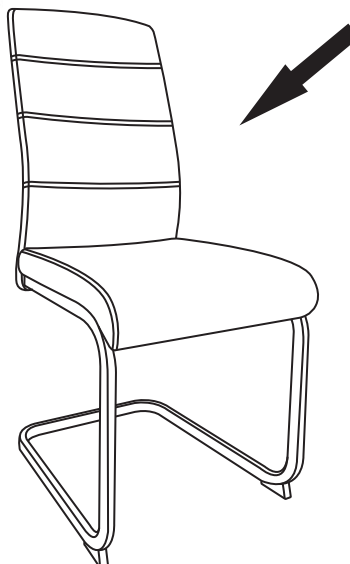

## MCA

Furniture

120KG

